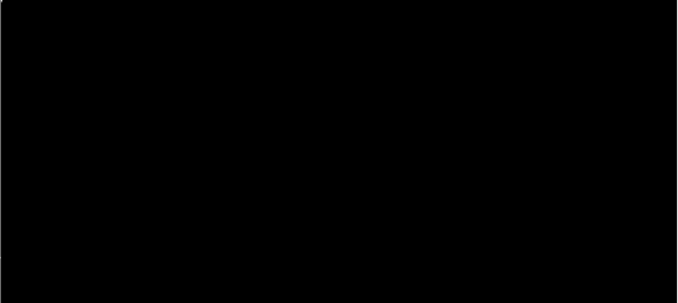

STATE OF NEW YORK CONTRACT AGREEMENT

<p><u>STATE AGENCY (Name & Address):</u> New York State Department of Corrections and Community Supervision The Harriman State Campus 1220 Washington Avenue Albany, New York 12226</p>	<p><u>BUSINESS UNIT:</u> DOC01</p> <p><u>NYS COMPTROLLER'S NUMBER</u> C161416</p> <p><u>DEPARTMENT CODE:</u> 3250226</p>
<p><u>CONTRACTOR</u> Securus Technologies, Inc. 14651 Dallas Parkway, Suite 600 Dallas, Texas 75254-8815</p>	<p><u>TYPE OF PROGRAM (S):</u> Inmate Telephone System</p>
	<p><u>INITIAL CONTRACT PERIOD</u></p> <p>FROM: October 1, 2017 TO: September 30, 2022</p> <p>TWO OPTIONAL ONE-YEAR RENEWALS</p> <p><u>FUNDING AMOUNT FOR INITIAL PERIOD</u> \$0.00</p>

APPENDICES ATTACHED AND PART OF THIS AGREEMENT:

- | | | |
|--------------|------------|--|
| <u> X </u> | Appendix A | Standard Clauses as required by the Attorney General for all State contracts |
| <u> X </u> | Appendix B | RFP, 2016-02, <i>Inmate Telephone System</i> , and all Addenda |
| <u> X </u> | Appendix C | Securus Technologies Technical Proposal |
| <u> X </u> | Appendix D | Securus Technologies Cost Proposal |
| <u> X </u> | Appendix E | Non-Disclosure Agreement |
| <u> X </u> | Appendix F | M/WBE Requirements |

IN WITNESS THEREOF, the parties hereto have executed or approved this AGREEMENT on the dates below their signatures.

<p>CONTRACTOR</p> <p><u>Securus Technologies, Inc.</u></p> <p>By: <u>D. J. Reahrd</u> <u>Dennis J Reahrd</u> Printed Name</p> <p>Title: <u>V.P. / General Counsel & Secretary</u></p> <p>Date: <u>6/14/17</u></p>	<p>Contract No. C161416</p> <p>STATE AGENCY</p> <p><u>New York State Department of Corrections and Community Supervision</u></p> <p>By: <u>Sandra Downey</u> SANDRA L. DOWNEY</p> <p>Title: <u>Director of Budget and Finance</u></p> <p>Date: <u>6/21/17</u></p> <p><u>State Agency Certification</u></p> <p>"In addition to the acceptance of this contract, I also certify that original copies of this signature page will be attached to all other exact copies of this contract."</p>
---	---

STATE OF NEW YORK

County of ALBANY) SS.:

On the 21st day of June, 2017, before me personally appeared

DENNIS J. REAHRD, to me known, who being by me duly sworn, did depose and say that he/she resides at 5552 Drone Drive, Dallas, TX, that he/she is the V.P. / General Counsel of the Securus Technologies, the corporation described herein which thereto by order of the board of directors of said corporation.

(Notary) [Signature]

ROBIN J LAWYER
 Notary Public, State of New York
 No. 01LA6332145
 Qualified in Saratoga County
 Commission Expires Oct. 26, 2019

ATTORNEY GENERAL'S SIGNATURE

STATE COMPTROLLER'S SIGNATURE

Title: Assistant to Form
 NYS ATTORNEY GENERAL

Date: JUL 14 2017

[Signature]
 BENJAMIN I. MAGGI
 ASSISTANT ATTORNEY GENERAL

Title: _____

Date: _____

APPROVED
 DEPT. OF AUDIT & CONTROL

NOV 9 2017

[Signature]
 FOR THE STATE COMPTROLLER

AGREEMENT

This AGREEMENT made this 21st day of June, 2017 between the NEW YORK STATE DEPARTMENT OF CORRECTIONS AND COMMUNITY SUPERVISION (hereinafter referred to as "DOCCS"), with its principal office located at The Harriman State Campus, 1220 Washington Avenue, Albany, New York 12226 and Securus Technologies, Inc. (hereinafter "CONTRACTOR"), with its principal office located at 14651 Dallas Parkway, Suite 600, Dallas, Texas 75254; and

WHEREAS, pursuant to New York Correction Law § 112(1), the Commissioner of DOCCS is given the authority to contract with private entities for the performance of such functions deemed necessary or desirable to promote the efficient operation of DOCCS, as well as the fulfillment of all lawful responsibilities of DOCCS; and

WHEREAS, the CONTRACTOR is ready, willing and able to provide such services and possesses or can make available all necessary qualified personnel, licenses, facilities and expertise to perform or have performed the services required pursuant to the terms of this AGREEMENT.

NOW THEREFORE, in consideration of the promises, responsibilities and covenants herein, the STATE and the CONTRACTOR agree as follows:

I. TERM

A. When signed by the parties and approved by all necessary government agencies, this AGREEMENT shall commence on October 1, 2017, and be in effect through September 30, 2022 ("Term") unless terminated earlier pursuant to its terms.

II. RENEWALS

A. DOCCS reserves the sole right to renew the Agreement for two additional one- year periods under the same terms and rates by notifying the contractor of its intention no less than one-hundred-eighty (180) days before the expiration of the original Agreement or 90 days before the end of the initial one year renewal period.

III. AMENDMENTS

A. This AGREEMENT may be amended only upon the mutual written agreement of the parties.

B. To modify the AGREEMENT within an existing Term or Renewal Term, the parties shall execute an amendment to the agreement. Any change in the scope, or change in the term, is subject to the approval of the Office of the State Comptroller.

IV. TERMINATION

A. Event of default: The contract may be terminated in the event of breach of any of its provisions by the Contractor, or if the Contractor's Services are deemed unsatisfactory in DOCCS's sole discretion, due to Contractor's fault or negligence, or that of its officers, employees, subcontractors, agents, licensees, licensors, or affiliates. In such event, DOCCS will send a written cure notice in accordance with the Notice provisions of the contract, and Contractor shall have thirty (30) days to correct the deficiencies noted. Notwithstanding the foregoing, the thirty (30) day cure period will be extended to ninety (90) days if the default is not reasonably susceptible to cure within such thirty (30) day period, but only if the Contractor has begun to cure the default during the thirty (30) day period and diligently pursues the cure of such default. If the deficiencies are not corrected within the specified time period, DOCCS may terminate this contract immediately upon written notice.

B. Deficient Certifications: If the awarded contract has a value greater than \$15,000, DOCCS shall have the right to terminate in the event the State Finance Law

sections 139-j and 139-k certifications executed by the Contractor are found to be false or incomplete. If the contract has a value of greater than \$100,000 and Contractor's sales for the immediately preceding four quarters were greater than \$300,000, or if the contract has a value of \$125,000 or greater, DOCCS shall have the right to terminate in the event the Contractor's Department of Taxation and Finance Contractor Certification form, ST 220-CA, statements are found to be false or incomplete.

C. Lack of Funds: If for any reason the State of New York terminates or reduces its appropriations to DOCCS, the awarded contract may be terminated or reduced at DOCCS's discretion, provided that no such reduction or termination shall apply to allowable costs already incurred by the Contractor where funds are available to the DOCCS for payment of such costs. In any event, no liability shall be incurred by the State (including DOCCS) beyond monies available for the purposes of the awarded contract.

D. DOCCS may terminate the awarded contract, upon written notice, in the event of any of the following: (i) Contractor makes an assignment for the benefit of creditors; (ii) a petition in bankruptcy or any insolvency proceeding is filed by or against Contractor and is not dismissed within thirty (30) days from the date of filing; or (iii) all or substantially all of Contractor's property is levied upon or sold in any judicial proceeding.

E. Convenience of DOCCS: The contract may be terminated at any time upon receipt of ninety (90) days prior written notice given by DOCCS for whatever reason.

F. DOCCS reserves the right to terminate immediately for cause, subject to the provisions of Section IV.A.

G. This AGREEMENT may be terminated at any time upon mutual written consent of DOCCS and the CONTRACTOR.

H. In the event of the termination of this AGREEMENT by either party, if applicable, DOCCS shall be liable for the actual and necessary expenses for services provided by CONTRACTOR up to and including the effective date of termination.

V. CONTRACTOR RESPONSIBILITY

A. The CONTRACTOR shall, at all times during the AGREEMENT term remain responsible. The CONTRACTOR agrees, if requested by the Commissioner of DOCCS or his designee, to present evidence of its continuing legal authority to do business in New York State, integrity, experience, ability, prior performance, and organizational and financial capacity.

B. The Commissioner of DOCCS or his designee, in his sole discretion, reserves the right to suspend any or all activities under this AGREEMENT, at any time, when he discovers information that calls into question the responsibility of the CONTRACTOR. In the event of such suspension, the CONTRACTOR will be given written notice outlining the particulars of such suspension. Upon issuance of such notice, the CONTRACTOR must comply with the terms of the suspension order. Contract activity may resume at such time as the Commissioner of DOCCS or his designee issues a written notice authorizing a resumption of performance under the Contract.

C. Upon written notice to the CONTRACTOR, and a reasonable opportunity to be heard with appropriate DOCCS officials or staff, the AGREEMENT may be terminated by the Commissioner of DOCCS or his designee at the CONTRACTOR'S expense where the CONTRACTOR is determined by the DOCCS Commissioner or his designee to be non-responsible. In such event, the Commissioner or his designee may complete the contractual requirements in any manner he may deem advisable and pursue available legal or equitable remedies for breach.

VI. REQUEST FOR PROPOSALS

A. After a recent Request for Proposals (RFP) for an Inmate Telephone System, DOCCS has determined that the CONTRACTOR is the successful bidder resulting in the best value for the state and the CONTRACTOR is willing and able to provide the services required.

VII. SCOPE OF SERVICES

A. Pursuant to this AGREEMENT, CONTRACTOR shall provide an Inmate Telephone System (the "System") in accordance with DOCCS' Request for Proposals (hereinafter "RFP") 2016-02, a true copy of which is annexed hereto and made a part hereof as Appendix B (RFP 2016-02); and the CONTRACTOR'S proposal for said RFP, a true copy of which is annexed hereto and made part of as Appendix C (Contractor's Proposal).

B. It is expressly understood and agreed by CONTRACTOR that any and all services and products specified in this AGREEMENT shall be provided only at the direction of DOCCS.

VIII. COMPENSATION

A. CONTRACTOR is responsible for ensuring that all telephone services and rates comply with all applicable regulations including, but not limited to, the NYS Public Service Commission (PSC) and the Federal Communications Commission (FCC) throughout the term of the contract. All rates shall be fixed unless changes are mandated by state and/or federal regulations. Contractor will bill account holders under the terms of the RFP and this contract as set forth in Appendix D (Contractor's Cost Proposal), which is attached hereto and made a part of hereof. Appendix D consists of the CONTRACTOR'S Cost Proposal submitted in response to RFP 2016-02.

C. Contract will not charge an Ancillary Service Charge other than those permitted charges identified by the FCC and approved by DOCCS, and will not charge a rate for a permitted Ancillary Service Charge in excess of those rates approved by the FCC and approved by DOCCS.

IX. PERFORMANCE/PAYMENT BOND REQUIREMENT

A. Prior to the commencement of performance of the work to be undertaken pursuant to the Contract, DOCCS requires the Contractor to furnish without cost to DOCCS a performance/payment bond as security for the faithful performance of the Contract in the amount of Ten Million Dollars (\$10,000,000.00), which shall be in the exact form and language of the sample bond attached as RFP 2016-02, Appendix L. The surety must be authorized to do business as a surety in the State of New York, and its name must appear on the current list of sureties acceptable to the Treasury Department of the United States in effect at the time of submission of the Performance and Payment Bond to DOCCS. Contractor will confirm for DOCCS that the surety remains authorized to do business as a surety in the State of New York and that its name appears on the current list of sureties as noted above on a yearly basis.

X. CONFIDENTIALITY

A. CONTRACTOR acknowledges that any and all State of New York and DOCCS information, records, files, documents or reports contained in any media format (e.g. print, electronic) provided to CONTRACTOR by the DOCCS or otherwise encountered by CONTRACTOR in the provision of services pursuant to this AGREEMENT, or as otherwise required by law, shall be considered confidential and shall be handled accordingly at all times. Neither CONTRACTOR nor any of its employees, servants, subcontractors, agents or volunteers shall at any time be permitted to utilize any such confidential information for any purpose outside the scope of this AGREEMENT without the express prior written authorization of DOCCS, except as otherwise required by law or judicial process. CONTRACTOR shall educate, monitor and be responsible

for its employees, servants, subcontractors, agents and volunteers providing services for CONTRACTOR pursuant to this AGREEMENT concerning these confidentiality requirements. Any breach of the confidentiality requirements set forth in this Section or in Appendix B by CONTRACTOR or by any of its employees, servants, subcontractors, agents or volunteers may result in the immediate termination of this AGREEMENT by the DOCCS and may subject the CONTRACTOR to further penalties. Annexed hereto as Appendix E is a copy of the Non-Disclosure Agreement.

XI. INDEPENDENT CONTRACTOR

A. It is expressly understood and agreed that CONTRACTOR'S status hereunder is that of an independent contractor and that no official, employee, servant, subcontractor, agent or volunteer of CONTRACTOR is an employee of the DOCCS or the State of New York. CONTRACTOR is solely responsible for the work, compensation, benefits and personal conduct of all such persons assigned to the provision of services pursuant to this AGREEMENT. Nothing contained in this Section or in any other provision of this AGREEMENT shall be construed to impose any liability or duty to the DOCCS or the State of New York to persons, firms, consultants or corporations employed or engaged or otherwise utilized by the CONTRACTOR, either directly or indirectly, in any capacity whatsoever, nor shall the DOCCS or the State of New York be liable for any acts, omissions, obligations and taxes of any nature, including unemployment insurance and worker's compensation, of CONTRACTOR or any of its officials, employees, servants, subcontractors, agents or volunteers.

XII. ASSIGNMENT

A. The rights and obligations of CONTRACTOR under this AGREEMENT may not be assigned, conveyed, transferred, or subcontracted by CONTRACTOR without prior written authorization of the DOCCS as set forth in Appendix A.

XIII. NOTICES

A. All notices made pursuant to this AGREEMENT shall be in writing and shall be delivered to the addresses set forth below or to such addresses as the parties may from time to time provide to each other. Said notices should be served via registered mail or personally.

Notification to DOCCS: NYS DOCCS
Contract Procurement Unit
The Harriman State Campus
1220 Washington Avenue
Albany, New York 12226

Notification to CONTRACTOR: Adam Mercer, Advisory Account Executive
Securus Technologies, Inc.
14651 Dallas Parkway, Suite 600
Dallas, Texas 75254

or any other address as may be hereinafter designated by written notice. No notice shall be effective until received by the addressee. Communications concerning the daily functions and operation of the scope of services are not to be considered as notices. Thus, such communications may be done via telephone, e-mail, fax, United States Postal Service or other means.

XIV. MISCELLANEOUS PROVISIONS

A. Entire Agreement: This AGREEMENT, including the face page and all its appendices, constitutes the entire AGREEMENT between the parties and supersedes all other communications between the parties relating to the subject matter herein.

B. Appendix A: DOCCS Appendix A (Standard Clauses as required by the Attorney General for all State contracts) is attached hereto and made a part hereof.

C. Order of Precedence: In the event of any conflict between the terms of this AGREEMENT and the terms of its Appendices, the following order of precedence shall apply:

1. Appendix A (Standard Clauses);
2. AGREEMENT;
3. Appendix B (RFP & all Addenda);
4. Appendix C (Technical Proposal);
5. Appendix D (Cost Proposal);
6. Appendix E (Nondisclosure Agreement);
7. Appendix F (M/WBE Requirements); and

D. Controlling Statutes: This AGREEMENT shall be governed by and construed in accordance with the laws of the State of New York.

E. Unenforceability: If any part of this AGREEMENT is found to be unenforceable for any reason, that part shall be deemed deleted and all other terms, conditions, and provisions of this AGREEMENT shall remain in full force and effect.

F. Captions: The captions contained in this AGREEMENT are intended for convenience and reference purposes only and shall in no way be deemed to define, limit or describe the scope or intent of this AGREEMENT, or any provision thereof, or in any way affect this AGREEMENT.

G. Indemnification, Limitation Of Liability

a. Indemnification

Contractor shall be fully liable for the actions of its agents, officers, employees, partners, or subcontractors, and shall fully indemnify and save harmless the State from suits, actions, damages, and costs of every name and description relating to personal injury and damage to real or personal property caused by Contractor, its agents, officers, employees, partners, or subcontractors, without

limitation; provided however, that the Contractor shall not indemnify for that portion of any claim, loss, or damage arising hereunder due to the negligent act or negligent failure to act of the State.

Contractor shall indemnify and hold the State harmless from any loss or damage to the State resulting from the violation by the Contractor, its agents, officers, employees, partners and subcontractors of State and ITS security procedures or policies resulting from any criminal acts committed by Contractor's officers, agents, employees, and subcontractors while providing Services under the Contract.

This section is not subject to the limitation of liability provisions of the Contract.

b. Indemnification for Intellectual Property Infringement

Contractor shall indemnify, defend, and hold the State harmless, without limitation, from and against any and all damages, expenses (including reasonable attorneys' fees and legal fees), claims, judgments, liabilities, and costs which may be assessed against the State in any action for infringement of a United States Letter Patent, or of any copyright, trademark, trade secret, or other third-party proprietary right in relation to the services, products, documentation or deliverables furnished or utilized by Contractor under this Contract, provided that the State shall give Contractor: (i) prompt written notice of any action, claim, or threat of infringement suit, or other suit, (ii) the opportunity to take over, settle or defend such action, claim or suit at Contractor's sole expense; and (iii) assistance in the defense of any such action at the expense of Contractor. Where a dispute or claim arises relative to a real or anticipated infringement, the State may require Contractor, at its sole expense, to submit such information and documentation, including formal patent attorney opinions, as the State shall require. This paragraph shall not apply to that portion of any infringement claim which results from a material

modification by the State, without Contractor's approval, of any products, documentation or deliverables furnished or utilized by Contractor pursuant to this Contract. Notwithstanding the foregoing, the State reserves the right to join such action, at its sole expense, when it determines that there is an issue involving a significant public interest. This section is not subject to the limitation of liability provisions of the Contract.

c. Limitation of Liability

For all other claims against the Contractor where liability is not otherwise set forth in the Contract as being "without limitation," and regardless of the basis on which the claim is made, Contractor's liability under the Contract for direct damages shall be limited to the greater of the following: (i) \$1,000,000 (One Million Dollars); or (ii) two (2) times the amounts paid to the Contractor under the Contract during the twelve (12) months of the contract term which precedes the giving of notice of the claim by the State. For this purpose, amounts paid shall include, but not be limited to, payments made electronically, by check, by offset, or by the application of credits from the Contractor to the State. Unless otherwise specifically enumerated herein, neither party shall be liable for any incidental, punitive, consequential, indirect or special damages of any kind which may result directly or indirectly from the performance of this contract, including, without limitation, damages resulting from loss of use or loss of profit by the state, the contractor, or by others, however caused and regardless of the theory of liability even if such party has been informed of the possibility of such damages. The limitations of liabilities, disclaimers of warranties, exclusivity of remedies, and other limitations are an essential element of the bargain between the parties (without which the transactions contemplated by this agreement would not occur) and will apply even if a remedy fails in its essential purpose.

d. No Indemnification by the State

H. The State does not agree to any indemnification provisions that require the State to indemnify or save harmless Contractor or third parties. Force Majeure: Neither party shall be liable for losses, defaults, or damages, under this AGREEMENT which result from delays in performing, or inability to perform, all or any of the obligations or responsibilities imposed upon it pursuant to the terms and conditions of this AGREEMENT, due to or because of acts of God, the public enemy, acts of government, earthquakes, floods, strikes, typhoons, civil strife, fire or any cause beyond the reasonable control of the party that was so delayed in performing or so unable to perform, provided that such party was not negligent and shall have used reasonable efforts to avoid and overcome such cause. Such party will resume full performance of such obligations and responsibilities promptly upon removal of any such cause.

I. Non-sectarian: CONTRACTOR is a non-sectarian organization and does not have as one of its purposes the advancement of any religion.

J. Strict Adherence: The failure of DOCCS to insist upon strict adherence to any provision, fiscal obligation, reporting or other requirement of this AGREEMENT shall not be considered to constitute a waiver or constructive modification to deprive DOCCS of the right to insist upon strict adherence to the terms of this AGREEMENT in the future.

K. M/WBE: By signing said AGREEMENT, CONTRACTOR agrees to comply with all requirements of Minority and Women Business Enterprise Laws, Regulations and Rules (M/WBE) Annexed hereto as Appendix F is a copy of the M/WBE policy.

L. Software License: The Contractor grants DOCCS a personal, non-exclusive, limited-transferable license (see (a) below) to access and use certain proprietary computer software products and materials in connection with the Applications (the "Software"). In connection therewith, DOCCS represents that (i) it will be responsible for distributing and assigning licenses to its end users, and (ii) it will monitor and ensure that its licensed end users comply with all the Contractor Use Terms and Conditions

and as directed herein. The Software includes any upgrades, modifications, updates, and additions to existing features that the Contractor implement in our discretion (the "Updates"). Updates do not include additional features and significant enhancements to existing features. DOCCS is the license holder of any third-party software products the Contractor obtain on DOCCS' behalf. The only preinstalled third-party software contemplated by this provision is Windows, which is preinstalled on workstations provided by Contractor to DOCCS. DOCCS authorizes the Contractor to provide or preinstall the third-party software and agree that the Contractor may agree to the third-party End User License Agreements ("EULA") on DOCCS' behalf. DOCCS' rights to the use of any third-party software product that the Contractors provide will be limited by the terms of the underlying license that the Contractor obtained for such product. Contractor further understands that it cannot pass through the terms of any license agreements or warranties to DOCCS in lieu of warranting them itself. With the exception of (a) of this section, the Software is to be used solely for DOCCS' internal business purposes in connection with the Applications at DOCCS' correctional facilities. Should a "permitted license transfer" occur any Third Party's use of the Software will be restricted per (b) below. DOCCS will not (i) permit any parent, subsidiary, affiliated entity, or third party to use the Software, (ii) assign, sublicense, lease, encumber, or otherwise transfer or attempt to transfer the Software or any portion thereof, (iii) process or permit to be processed any data of any other party with the Software, (iv) alter, maintain, enhance, disassemble, decompile, reverse engineer or otherwise modify the Software or allow any third party to do so, (v) connect the Software to any products that the Contractor did not furnish or approve in writing, or (vi) ship, transfer, or export the Software into any country, or use the Software in any manner prohibited by the export laws of the United States. The Contractor is not liable with regard to any Software that DOCCS uses in a prohibited manner. Contractor will comply with the Warranties provisions of the General Specifications, Appendix B to the RFP (attached), which requires Contractor to warranty all deliverables provided in connection with the Contract, regardless of the source.

a. Permitted License Transfers As Licensee's business operations may be altered, expanded or diminished, licenses granted hereunder may be transferred or combined for use at an alternative or consolidated Site not originally specified in the license,

including transfers within Agencies, between Agencies, and pursuant to governmental restructuring or reorganization ("permitted license transfers"). Licensees do not have to obtain the approval of Contractor for permitted license transfers, but must give 30 days prior written notice to Contractor of such moves and certify in writing that the Product is not in use at the prior Site. There shall be no additional license or other transfer fees due Contractor, provided that: (i) the maximum capacity of the consolidated machine is equal to the combined individual license capacity of all licenses running at the consolidated or transferred Site (e.g., named users, seats, or MIPS); or (ii) if the maximum capacity of the consolidated machine is greater than the individual license capacity being transferred, a logical or physical partition or other means of restricting access will be maintained within the computer system so as to restrict use and access to the Product to that unit of licensed capacity solely dedicated to beneficial use for Licensee. In the event that the maximum capacity of the consolidated machine is greater than the combined individual license capacity of all licenses running at the consolidated or transferred Site, and a logical or physical partition or other means of restricting use is not available, the fees due Contractor shall not exceed the fees otherwise payable for a single license for the upgrade capacity.

b. Restricted Use By Third Parties Third parties retained by Licensee shall have the right to use the Product to maintain Licensee's business operations, including data processing, for the time period that they are engaged in such activities, provided that: (i) Licensee gives notice to Contractor of such third party, Site of intended use of the Product, and means of access; and (ii) such third party has executed, or agrees to execute, the Product manufacturer's standard nondisclosure or restricted use agreement, which executed agreement shall be accepted by the Contractor ("Non-Disclosure Agreement"); and (iii) such third party maintains a logical or physical partition within its computer system so as to restrict use and access to the program to that portion solely dedicated to beneficial use for Licensee. In no event shall Licensee assume any liability for third party's compliance with the terms of the Non-Disclosure Agreement, nor shall the Non-Disclosure Agreement create or impose any liabilities on the State or Licensee.

"Above Revisions Agreed to and Accepted"
DDR / 7/14/17 MM / 7/14/17
Contractor Initial / Date DOCCS Initial / Date

M. Ownership and Use: All on-site equipment installed to support the System and the Applications, and related records, data, and information, including recorded communications and, if applicable, e-mails, or any other information by or about DOCCS inmates or employees will at all times remain DOCCS' sole and exclusive property unless prohibited by law. The Contractor will retain sole and exclusive rights to the System, Software and the associated Applications.

During the term of this Agreement and for a reasonable period of time thereafter, the Contractor will provide DOCCS with reasonable access to the records. The Contractor (or our licensors, if any) have and will retain all right, title, interest, and ownership in and to (i) the Software and any copies, customer versions, modifications, or updates of the Software, (ii) all related documentation, and (iii) any trade secrets, know-how, methodologies, and processes related to our Applications, the System, and our other products and services (the "Materials"). The Materials constitute proprietary information and trade secrets of the Contractor and its licensors, whether or not any portion thereof is or may be the subject of a valid copyright or patent.

N. Legality/Limited License Agreement: For services related to Applications which may allow DOCCS to monitor and record inmate or other administrative telephone calls, or transmit or receive inmate electronic messages ("e-mail"); by providing the Application, the Contractor make no representation or warranty as to the legality of recording or monitoring inmate or administrative telephone calls or transmitting or receiving inmate e-mail messages. Further, DOCCS' retains custody and ownership of all recordings, and inmate e-mail messages; however DOCCS grants the Contractor a limited license, for the term of this agreement, to compile, store, and access recordings or inmate calls and access inmate e-mail messages for purposes of (i) complying with the requests of officials at DOCCS Facilities, (ii) disclosing information, as required by law, to requesting law enforcement and correctional officials as they may require for investigative, penological or public safety purposes, (iii) performing billing and collection functions, or (iv) maintaining equipment and quality control purposes. This license does not apply to recordings of inmate calls or e-mail messages with their attorneys or to recordings or e-mail messages protected from disclosure by other applicable privileges.

O. Private Number Designation: The Contractor will provide DOCCS with the ability to designate certain numbers (for example, attorney or clergy numbers) as "Private" within the Contractor's Call Platform. Calls to numbers designated as Private will not be recorded by the Contractor. Although the Contractor will maintain DOCCS' Private list within the Contractor's Call Platform, DOCCS acknowledges and agrees that DOCCS will have the sole discretion, authority, and responsibility for designating numbers as Private, and that the Contractor has no discretion, authority, or responsibility for making such designations, unless done so at DOCCS' instruction.

P. Confidentiality and Non-Disclosure: The System, Applications, and related call records and information (the "Confidential Information") will at all times remain confidential to the Contractor. DOCCS understands and acknowledges that the Contractor, as a common carrier, is required by Section 222 of the Communications Act of 1934, as amended, 47 U.S.C. Section 222, to maintain the confidentiality of "Customer Proprietary Network Information", or "CPNI", which protects from disclosure consumers' sensitive personal information (including phone numbers called by a consumer; the frequency, duration, and timing of such calls; and any services purchased by the consumer).

Q. No Third-party Beneficiary Rights. Unless otherwise allowed within this contract, the parties do not intend to create in any other individual or entity the status of a third-party beneficiary, and this Contract will not be construed so as to create such status. The rights, duties, and obligations contained herein will operate only between the parties and will inure solely to their benefit. The provisions of this Contract are intended to assist only the parties in determining and performing their obligations hereunder, and the parties intend and expressly agree that they, or their agents/representatives, will have any legal or equitable right to seek to enforce this Contract, to seek any remedy arising out of a party's performance or failure to perform any term or condition of this Contract, or to bring an action for the breach of this Contract.

XV. APPLICATION TERMS OF USE

A. DOCCS' use of the Contractor's Applications is governed by the following Terms of Use.

THREADS™

DESCRIPTION:

The THREADS™ application allows authorized law enforcement users to analyze corrections and communications data from multiple sources to generate targeted investigative leads. THREADS™ has three main components: data analysis, data review, and data import. In addition, THREADS™ offers an optional "community" feature, which allows member correctional facilities to access and analyze corrections communications data from other correctional facilities within the community and data imported by other community members. DOCCS' use of THREADS™ is governed by and conditioned upon the terms set forth herein.

THREADS™ TERMS OF USE:

1. DOCCS will comply with all privacy, consumer protection, marketing, and data security laws and government guidelines applicable to DOCCS' access to and use of information obtained in connection with or through the THREADS™ application. DOCCS acknowledges and understands that the DOCCS is solely responsible for its compliance with such laws and that the Contractor makes no representation or warranty as to the legality of the use of the THREADS™ application or the information obtained in connection therewith. The Contractor will have no obligation, responsibility, or liability for DOCCS' compliance with any and all laws, regulations, policies, rules or other requirements applicable to DOCCS by virtue of its use of the THREADS™ application.
2. DOCCS acknowledges that the information available through the THREADS™ application includes personally identifiable information and that it is DOCCS' obligation to keep all such accessed information secure. Accordingly, DOCCS will (a) restrict access to THREADS™ to those law enforcement personnel who have a need to know

as part of their official duties; (b) ensure that its employees (i) obtain and/or use information from the THREADS™ application only for lawful purposes and (ii) transmit or disclose any such information only as permitted or required by law; (c) keep all user identification numbers confidential and prohibit the sharing of user identification numbers; (d) use commercially reasonable efforts to monitor and prevent against unauthorized access to or use of the THREADS™ application and any information derived therefrom (whether in electronic form or hard copy); and (e) notify the Contractor promptly of any such unauthorized access or use that DOCCS discovers or otherwise becomes aware of.

3. DOCCS understands and acknowledges that all information used and obtained in connection with the THREADS™ application is "**AS IS**." DOCCS further understands and acknowledges that THREADS™ uses data from third-party sources, which may or may not be thorough and/or accurate, and that DOCCS will not rely on the Contractor for the accuracy or completeness of information obtained through the THREADS™ application. DOCCS understands and acknowledges that DOCCS may be restricted from accessing certain aspects of the THREADS™ application which may be otherwise available. The Contractor reserves the right to modify, enhance, or discontinue any of the features that are currently part of the THREADS™ application. Moreover, if the Contractor determines in its sole discretion that the THREADS™ application and/or DOCCS' use thereof (1) violates the terms and conditions set forth herein and/or in the Agreement or (2) violates any law or regulation or (3) is reasonably likely to be so determined, the Contractor may, upon written notice, immediately terminate DOCCS' access to the THREADS™ application and will have no further liability or responsibility to DOCCS with respect thereto.

4. THE CONTRACTOR DOES NOT MAKE AND HEREBY DISCLAIMS ANY WARRANTY, EXPRESS OR IMPLIED, WITH RESPECT TO THE THREADS™ APPLICATION. THE CONTRACTOR DOES NOT GUARANTEE OR WARRANT THE CORRECTNESS, COMPLETENESS, LEGALITY, MERCHANTABILITY, OR FITNESS FOR A PARTICULAR PURPOSE OF THE THREADS™ APPLICATION OR INFORMATION OBTAINED IN CONNECTION THEREWITH.

5. DOCCS participation in THREADS may be terminated at any time upon receipt of thirty (30) days prior written notice given by DOCCS for whatever reason. If such

notice is given, all DOCCS information will immediately be purged from the THREADS database.

LOCATION BASED SERVICES

DESCRIPTION:

The Contractor's Location Based Services ("LBS") provides DOCCS with a mobile device user's approximate geographical location ("Mobile Location Data" or "MLD") by way of (i) information derived from calls placed on a Contractor device by an inmate confined at a DOCCS Facility and received by such mobile device user, or (ii) mobile device user information (such as mobile device number) provided to the Contractor by DOCCS. When a mobile device user's prior approval is required by law for MLD to be provided to DOCCS, such approval will be obtained in accordance with wireless carrier-approved disclosure and opt-in processes. LBS will capture approximate latitude and longitude coordinates of a mobile device user at the times at which the called party accepts the call, and when the call ends. LBS will display geographical information on a map and will combine covert alert functionality with approximate geographical coordinates when calls are accepted by the called party or end, and operate on demand in (near) real time. DOCCS' use of LBS is governed by and conditioned upon the terms set forth herein.

LBS TERMS OF USE:

1. DOCCS will comply with all privacy, consumer protection, marketing, and data security laws and government guidelines applicable to DOCCS' access to and use of information obtained in connection with or through the Location-Based Services application. DOCCS acknowledges and understands that the DOCCS is solely responsible for its compliance with such laws and that the Contractor makes no representation or warranty as to the legality of the use by DOCCS of the Location-Based Services application or the information obtained in connection therewith. The Contractor will have no obligation, responsibility, or liability for DOCCS' compliance with any and all laws, regulations, policies, rules or other requirements applicable to DOCCS by virtue of its use of the Location-Based Services application.

2. DOCCS acknowledges that the information available through the Location-Based Services application includes personally identifiable information and that it is DOCCS' obligation to keep all such accessed information secure. Accordingly, DOCCS will (a) restrict access to Location-Based Services to those law enforcement personnel who have a need to know as part of their official duties; (b) ensure that its employees (i) obtain and/or use information from the Location-Based Services application only for lawful purposes and (ii) transmit or disclose any such information only as permitted or required by law; (c) keep all user identification numbers confidential and prohibit the sharing of user identification numbers; (d) use commercially reasonable efforts to monitor and prevent against unauthorized access to or use of the Location-Based Services application and any information derived therefrom (whether in electronic form or hard copy); and (e) notify the Contractor promptly of any such unauthorized access or use that DOCCS discovers or otherwise becomes aware of.

3. DOCCS understands and acknowledges that all information used and obtained in connection with the Location-Based Services application is "AS IS." DOCCS further understands and acknowledges that Location-Based Services uses data from third-party sources, which may or may not be thorough and/or accurate, and that DOCCS will not rely on the Contractor for the accuracy or completeness of information obtained through the Location-Based Services application. DOCCS understands and acknowledges that DOCCS may be restricted from accessing certain aspects of the Location-Based Services application which may be otherwise available. The Contractor reserves the right to modify, enhance, or discontinue any of the features that are currently part of the Location-Based Services application. Moreover, if the Contractor determines in its sole discretion that the Location-Based Services application and/or DOCCS' use thereof (1) violates the terms and conditions set forth herein and/or in the Agreement or (2) violates any law or regulation or (3) is reasonably likely to be so determined, the Contractor may, upon written notice, immediately terminate DOCCS' access to the Location-Based

Services application and will have no further liability or responsibility to DOCCS with respect thereto.

4. THE CONTRACTOR DOES NOT MAKE AND HEREBY DISCLAIMS ANY WARRANTY, EXPRESS OR IMPLIED, WITH RESPECT TO THE LOCATION-BASED SERVICES APPLICATION. THE CONTRACTOR DOES NOT GUARANTEE OR WARRANT THE CORRECTNESS, COMPLETENESS, LEGALITY, MERCHANTABILITY, OR FITNESS FOR A PARTICULAR PURPOSE OF THE LOCATION-BASED SERVICES APPLICATION OR INFORMATION OBTAINED IN CONNECTION THEREWITH.

GUARDED EXCHANGE™

DESCRIPTION:

The Contractor, through its subsidiary Guarded Exchange™, will provide an Offender Call Monitoring System (“GEX System”) which includes call monitoring services of inmate calls originating from the Facility(s) that is designed to identify:

1. Suspicious or suggestive key words or phrases;
2. Phrases that suggest threats to security of the Facility(s) and Facility personnel;
and
3. Criminal activity in and outside of the Facility(s);

TERMS OF USE:

1. DOCCS agrees and acknowledges that it will use information received from the GEX System only for legitimate law enforcement, investigatory, and penological purposes.
2. DOCCS will comply with all privacy, consumer protection, marketing, and data security laws and government guidelines applicable to its access to and use of information obtained in connection with or through the GEX System. DOCCS acknowledges and understands that DOCCS is solely responsible for its compliance with such laws and that neither the Contractor nor Guarded Exchange™ make any representation or warranty as to the legality of the use of

the GEX System or the information obtained in connection therewith. Neither the Contractor nor Guarded Exchange™ will have any obligation, responsibility, or liability for DOCCS' compliance with any and all laws, regulations, policies, rules or other requirements applicable to DOCCS by virtue of its use of the GEX System.

3. DOCCS acknowledges that the information available through the GEX System includes personally identifiable information and that it is DOCCS' obligation to keep all such accessed information secure. Accordingly, DOCCS will (1) restrict access to the GEX System to those law enforcement personnel who have a need to know as part of their official duties; (2) ensure that its employees (i) obtain and/or use information from the System only for lawful purposes and (ii) transmit or disclose any such information only as permitted or required by law; (3) keep all user identification numbers confidential and prohibit the sharing of user identification numbers; (4) use commercially reasonable efforts to monitor and prevent against unauthorized access to or use of the GEX System and any information derived therefrom (whether in electronic form or hard copy); and (5) notify the Contractor and Guarded Exchange™ promptly of any such unauthorized access or use that DOCCS discovers or otherwise becomes aware of.

4. DOCCS understands and acknowledges that all information used and obtained in connection with the GEX System is "AS IS." If the Contractor or Guarded Exchange™ determine in either's sole discretion that the GEX System and/or DOCCS' use thereof (1) violates the terms and conditions set forth herein or (2) violates any law or regulation or (3) is reasonably likely to be so determined, either the Contractor or Guarded Exchange™ may, upon written notice, immediately terminate DOCCS' access to the GEX System and will have no further liability or responsibility to DOCCS with respect thereto. DOCCS further acknowledges and agrees that the GEX System is not infallible, and that neither the Contractor nor Guarded Exchange™ make any representations or warranties regarding the GEX System's ability to identify suspicious or suggestive key words or phrases, phrases that suggest threats to security, or phrases that indicated criminal activity in and outside of the Facility(s).

5. NEITHER PROVIDER NOR GUARDED EXCHANGE™ MAKE AND DO HEREBY DISCLAIM ANY WARRANTY, EXPRESS OR IMPLIED, WITH RESPECT TO THE GEX SYSTEM. NEITHER PROVIDER NOR GUARDED EXCHANGE™ GUARANTEE OR WARRANT THE CORRECTNESS, COMPLETENESS, LEGALITY, MERCHANTABILITY, OR FITNESS FOR A PARTICULAR PURPOSE OF THE GEX SYSTEM.

APPENDIX A

STANDARD CLAUSES FOR NEW YORK STATE CONTRACTS

**PLEASE RETAIN THIS DOCUMENT
FOR FUTURE REFERENCE.**

TABLE OF CONTENTS

	Page
1. Executory Clause	3
2. Non-Assignment Clause	3
3. Comptroller's Approval	3
4. Workers' Compensation Benefits	3
5. Non-Discrimination Requirements	3
6. Wage and Hours Provisions	3
7. Non-Collusive Bidding Certification	4
8. International Boycott Prohibition	4
9. Set-Off Rights	4
10. Records	4
11. Identifying Information and Privacy Notification	4
12. Equal Employment Opportunities For Minorities and Women	4-5
13. Conflicting Terms	5
14. Governing Law	5
15. Late Payment	5
16. No Arbitration	5
17. Service of Process	5
18. Prohibition on Purchase of Tropical Hardwoods	5-6
19. MacBride Fair Employment Principles	6
20. Omnibus Procurement Act of 1992	6
21. Reciprocity and Sanctions Provisions	6
22. Compliance with New York State Information Security Breach and Notification Act	6
23. Compliance with Consultant Disclosure Law	6
24. Procurement Lobbying	7
25. Certification of Registration to Collect Sales and Compensating Use Tax by Certain State Contractors, Affiliates and Subcontractors	7
26. Iran Divestment Act	7

STANDARD CLAUSES FOR NYS CONTRACTS

The parties to the attached contract, license, lease, amendment or other agreement of any kind (hereinafter, "the contract" or "this contract") agree to be bound by the following clauses which are hereby made a part of the contract (the word "Contractor" herein refers to any party other than the State, whether a contractor, licenser, licensee, lessor, lessee or any other party):

1. EXECUTORY CLAUSE. In accordance with Section 41 of the State Finance Law, the State shall have no liability under this contract to the Contractor or to anyone else beyond funds appropriated and available for this contract.

2. NON-ASSIGNMENT CLAUSE. In accordance with Section 138 of the State Finance Law, this contract may not be assigned by the Contractor or its right, title or interest therein assigned, transferred, conveyed, sublet or otherwise disposed of without the State's previous written consent, and attempts to do so are null and void. Notwithstanding the foregoing, such prior written consent of an assignment of a contract let pursuant to Article XI of the State Finance Law may be waived at the discretion of the contracting agency and with the concurrence of the State Comptroller where the original contract was subject to the State Comptroller's approval, where the assignment is due to a reorganization, merger or consolidation of the Contractor's business entity or enterprise. The State retains its right to approve an assignment and to require that any Contractor demonstrate its responsibility to do business with the State. The Contractor may, however, assign its right to receive payments without the State's prior written consent unless this contract concerns Certificates of Participation pursuant to Article 5-A of the State Finance Law.

3. COMPTROLLER'S APPROVAL. In accordance with Section 112 of the State Finance Law (or, if this contract is with the State University or City University of New York, Section 355 or Section 6218 of the Education Law), if this contract exceeds \$50,000 (or the minimum thresholds agreed to by the Office of the State Comptroller for certain S.U.N.Y. and C.U.N.Y. contracts), or if this is an amendment for any amount to a contract which, as so amended, exceeds said statutory amount, or if, by this contract, the State agrees to give something other than money when the value or reasonably estimated value of such consideration exceeds \$10,000, it shall not be valid, effective or binding upon the State until it has been approved by the State Comptroller and filed in his office. Comptroller's approval of contracts let by the Office of General Services is required when such contracts exceed \$85,000 (State Finance Law Section 163.6-a). However, such pre-approval shall not be required for any contract established as a centralized contract through the Office of General Services or for a purchase order or other transaction issued under such centralized contract.

4. WORKERS' COMPENSATION BENEFITS. In accordance with Section 142 of the State Finance Law, this

contract shall be void and of no force and effect unless the Contractor shall provide and maintain coverage during the life of this contract for the benefit of such employees as are required to be covered by the provisions of the Workers' Compensation Law.

5. NON-DISCRIMINATION REQUIREMENTS. To the extent required by Article 15 of the Executive Law (also known as the Human Rights Law) and all other State and Federal statutory and constitutional non-discrimination provisions, the Contractor will not discriminate against any employee or applicant for employment because of race, creed, color, sex (including gender identity or expression), national origin, sexual orientation, military status, age, disability, predisposing genetic characteristics, marital status or domestic violence victim status. Furthermore, in accordance with Section 220-e of the Labor Law, if this is a contract for the construction, alteration or repair of any public building or public work or for the manufacture, sale or distribution of materials, equipment or supplies, and to the extent that this contract shall be performed within the State of New York, Contractor agrees that neither it nor its subcontractors shall, by reason of race, creed, color, disability, sex, or national origin: (a) discriminate in hiring against any New York State citizen who is qualified and available to perform the work; or (b) discriminate against or intimidate any employee hired for the performance of work under this contract. If this is a building service contract as defined in Section 230 of the Labor Law, then, in accordance with Section 239 thereof, Contractor agrees that neither it nor its subcontractors shall by reason of race, creed, color, national origin, age, sex or disability: (a) discriminate in hiring against any New York State citizen who is qualified and available to perform the work; or (b) discriminate against or intimidate any employee hired for the performance of work under this contract. Contractor is subject to fines of \$50.00 per person per day for any violation of Section 220-e or Section 239 as well as possible termination of this contract and forfeiture of all moneys due hereunder for a second or subsequent violation.

6. WAGE AND HOURS PROVISIONS. If this is a public work contract covered by Article 8 of the Labor Law or a building service contract covered by Article 9 thereof, neither Contractor's employees nor the employees of its subcontractors may be required or permitted to work more than the number of hours or days stated in said statutes, except as otherwise provided in the Labor Law and as set forth in prevailing wage and supplement schedules issued by the State Labor Department. Furthermore, Contractor and its subcontractors must pay at least the prevailing wage rate and pay or provide the prevailing supplements, including the premium rates for overtime pay, as determined by the State Labor Department in accordance with the Labor Law. Additionally, effective April 28, 2008, if this is a public work contract covered by Article 8 of the Labor Law, the Contractor understands and agrees that the filing of payrolls in a manner consistent with Subdivision 3-a of Section 220 of the Labor Law shall be a condition precedent to payment by the State of

any State approved sums due and owing for work done upon the project.

7. NON-COLLUSIVE BIDDING CERTIFICATION. In accordance with Section 139-d of the State Finance Law, if this contract was awarded based upon the submission of bids, Contractor affirms, under penalty of perjury, that its bid was arrived at independently and without collusion aimed at restricting competition. Contractor further affirms that, at the time Contractor submitted its bid, an authorized and responsible person executed and delivered to the State a non-collusive bidding certification on Contractor's behalf.

8. INTERNATIONAL BOYCOTT PROHIBITION. In accordance with Section 220-f of the Labor Law and Section 139-h of the State Finance Law, if this contract exceeds \$5,000, the Contractor agrees, as a material condition of the contract, that neither the Contractor nor any substantially owned or affiliated person, firm, partnership or corporation has participated, is participating, or shall participate in an international boycott in violation of the federal Export Administration Act of 1979 (50 USC App. Sections 2401 et seq.) or regulations thereunder. If such Contractor, or any of the aforesaid affiliates of Contractor, is convicted or is otherwise found to have violated said laws or regulations upon the final determination of the United States Commerce Department or any other appropriate agency of the United States subsequent to the contract's execution, such contract, amendment or modification thereto shall be rendered forfeit and void. The Contractor shall so notify the State Comptroller within five (5) business days of such conviction, determination or disposition of appeal (2NYCRR 105.4).

9. SET-OFF RIGHTS. The State shall have all of its common law, equitable and statutory rights of set-off. These rights shall include, but not be limited to, the State's option to withhold for the purposes of set-off any moneys due to the Contractor under this contract up to any amounts due and owing to the State with regard to this contract, any other contract with any State department or agency, including any contract for a term commencing prior to the term of this contract, plus any amounts due and owing to the State for any other reason including, without limitation, tax delinquencies, fee delinquencies or monetary penalties relative thereto. The State shall exercise its set-off rights in accordance with normal State practices including, in cases of set-off pursuant to an audit, the finalization of such audit by the State agency, its representatives, or the State Comptroller.

10. RECORDS. The Contractor shall establish and maintain complete and accurate books, records, documents, accounts and other evidence directly pertinent to performance under this contract (hereinafter, collectively, "the Records"). The Records must be kept for the balance of the calendar year in which they were made and for six (6) additional years thereafter. The State Comptroller, the Attorney General and any other person or entity authorized to conduct an examination, as well as the agency or agencies involved in this

contract, shall have access to the Records during normal business hours at an office of the Contractor within the State of New York or, if no such office is available, at a mutually agreeable and reasonable venue within the State, for the term specified above for the purposes of inspection, auditing and copying. The State shall take reasonable steps to protect from public disclosure any of the Records which are exempt from disclosure under Section 87 of the Public Officers Law (the "Statute") provided that: (i) the Contractor shall timely inform an appropriate State official, in writing, that said records should not be disclosed; and (ii) said records shall be sufficiently identified; and (iii) designation of said records as exempt under the Statute is reasonable. Nothing contained herein shall diminish, or in any way adversely affect, the State's right to discovery in any pending or future litigation.

11. IDENTIFYING INFORMATION AND PRIVACY NOTIFICATION.

(a) Identification Number(s). Every invoice or New York State Claim for Payment submitted to a New York State agency by a payee, for payment for the sale of goods or services or for transactions (e.g., leases, easements, licenses, etc.) related to real or personal property must include the payee's identification number. The number is any or all of the following: (i) the payee's Federal employer identification number, (ii) the payee's Federal social security number, and/or (iii) the payee's Vendor Identification Number assigned by the Statewide Financial System. Failure to include such number or numbers may delay payment. Where the payee does not have such number or numbers, the payee, on its invoice or Claim for Payment, must give the reason or reasons why the payee does not have such number or numbers.

(b) Privacy Notification. (1) The authority to request the above personal information from a seller of goods or services or a lessor of real or personal property, and the authority to maintain such information, is found in Section 5 of the State Tax Law. Disclosure of this information by the seller or lessor to the State is mandatory. The principal purpose for which the information is collected is to enable the State to identify individuals, businesses and others who have been delinquent in filing tax returns or may have understated their tax liabilities and to generally identify persons affected by the taxes administered by the Commissioner of Taxation and Finance. The information will be used for tax administration purposes and for any other purpose authorized by law. (2) The personal information is requested by the purchasing unit of the agency contracting to purchase the goods or services or lease the real or personal property covered by this contract or lease. The information is maintained in the Statewide Financial System by the Vendor Management Unit within the Bureau of State Expenditures, Office of the State Comptroller, 110 State Street, Albany, New York 12236.

12. EQUAL EMPLOYMENT OPPORTUNITIES FOR MINORITIES AND WOMEN.

In accordance with Section 312 of the Executive Law and 5 NYCRR 143, if this contract is: (i) a written agreement or purchase order instrument, providing for a total expenditure in excess of \$25,000.00,

whereby a contracting agency is committed to expend or does expend funds in return for labor, services, supplies, equipment, materials or any combination of the foregoing, to be performed for, or rendered or furnished to the contracting agency; or (ii) a written agreement in excess of \$100,000.00 whereby a contracting agency is committed to expend or does expend funds for the acquisition, construction, demolition, replacement, major repair or renovation of real property and improvements thereon; or (iii) a written agreement in excess of \$100,000.00 whereby the owner of a State assisted housing project is committed to expend or does expend funds for the acquisition, construction, demolition, replacement, major repair or renovation of real property and improvements thereon for such project, then the following shall apply and by signing this agreement the Contractor certifies and affirms that it is Contractor's equal employment opportunity policy that:

(a) The Contractor will not discriminate against employees or applicants for employment because of race, creed, color, national origin, sex, age, disability or marital status, shall make and document its conscientious and active efforts to employ and utilize minority group members and women in its work force on State contracts and will undertake or continue existing programs of affirmative action to ensure that minority group members and women are afforded equal employment opportunities without discrimination. Affirmative action shall mean recruitment, employment, job assignment, promotion, upgradings, demotion, transfer, layoff, or termination and rates of pay or other forms of compensation;

(b) at the request of the contracting agency, the Contractor shall request each employment agency, labor union, or authorized representative of workers with which it has a collective bargaining or other agreement or understanding, to furnish a written statement that such employment agency, labor union or representative will not discriminate on the basis of race, creed, color, national origin, sex, age, disability or marital status and that such union or representative will affirmatively cooperate in the implementation of the Contractor's obligations herein; and

(c) the Contractor shall state, in all solicitations or advertisements for employees, that, in the performance of the State contract, all qualified applicants will be afforded equal employment opportunities without discrimination because of race, creed, color, national origin, sex, age, disability or marital status.

Contractor will include the provisions of "a", "b", and "c" above, in every subcontract over \$25,000.00 for the construction, demolition, replacement, major repair, renovation, planning or design of real property and improvements thereon (the "Work") except where the Work is for the beneficial use of the Contractor. Section 312 does not apply to: (i) work, goods or services unrelated to this contract; or (ii) employment outside New York State. The State shall consider compliance by a contractor or subcontractor with the requirements of any federal law concerning equal employment

opportunity which effectuates the purpose of this section. The contracting agency shall determine whether the imposition of the requirements of the provisions hereof duplicate or conflict with any such federal law and if such duplication or conflict exists, the contracting agency shall waive the applicability of Section 312 to the extent of such duplication or conflict. Contractor will comply with all duly promulgated and lawful rules and regulations of the Department of Economic Development's Division of Minority and Women's Business Development pertaining hereto.

13. CONFLICTING TERMS. In the event of a conflict between the terms of the contract (including any and all attachments thereto and amendments thereof) and the terms of this Appendix A, the terms of this Appendix A shall control.

14. GOVERNING LAW. This contract shall be governed by the laws of the State of New York except where the Federal supremacy clause requires otherwise.

15. LATE PAYMENT. Timeliness of payment and any interest to be paid to Contractor for late payment shall be governed by Article 11-A of the State Finance Law to the extent required by law.

16. NO ARBITRATION. Disputes involving this contract, including the breach or alleged breach thereof, may not be submitted to binding arbitration (except where statutorily authorized), but must, instead, be heard in a court of competent jurisdiction of the State of New York.

17. SERVICE OF PROCESS. In addition to the methods of service allowed by the State Civil Practice Law & Rules ("CPLR"), Contractor hereby consents to service of process upon it by registered or certified mail, return receipt requested. Service hereunder shall be complete upon Contractor's actual receipt of process or upon the State's receipt of the return thereof by the United States Postal Service as refused or undeliverable. Contractor must promptly notify the State, in writing, of each and every change of address to which service of process can be made. Service by the State to the last known address shall be sufficient. Contractor will have thirty (30) calendar days after service hereunder is complete in which to respond.

18. PROHIBITION ON PURCHASE OF TROPICAL HARDWOODS. The Contractor certifies and warrants that all wood products to be used under this contract award will be in accordance with, but not limited to, the specifications and provisions of Section 165 of the State Finance Law, (Use of Tropical Hardwoods) which prohibits purchase and use of tropical hardwoods, unless specifically exempted, by the State or any governmental agency or political subdivision or public benefit corporation. Qualification for an exemption under this law will be the responsibility of the contractor to establish to meet with the approval of the State.

In addition, when any portion of this contract involving the use of woods, whether supply or installation, is to be performed by any subcontractor, the prime Contractor will indicate and certify in the submitted bid proposal that the subcontractor has been informed and is in compliance with specifications and provisions regarding use of tropical hardwoods as detailed in §165 State Finance Law. Any such use must meet with the approval of the State; otherwise, the bid may not be considered responsive. Under bidder certifications, proof of qualification for exemption will be the responsibility of the Contractor to meet with the approval of the State.

19. MACBRIDE FAIR EMPLOYMENT PRINCIPLES.

In accordance with the MacBride Fair Employment Principles (Chapter 807 of the Laws of 1992), the Contractor hereby stipulates that the Contractor either (a) has no business operations in Northern Ireland, or (b) shall take lawful steps in good faith to conduct any business operations in Northern Ireland in accordance with the MacBride Fair Employment Principles (as described in Section 165 of the New York State Finance Law), and shall permit independent monitoring of compliance with such principles.

20. OMNIBUS PROCUREMENT ACT OF 1992. It is the policy of New York State to maximize opportunities for the participation of New York State business enterprises, including minority and women-owned business enterprises as bidders, subcontractors and suppliers on its procurement contracts.

Information on the availability of New York State subcontractors and suppliers is available from:

NYS Department of Economic Development
Division for Small Business
Albany, New York 12245
Telephone: 518-292-5100
Fax: 518-292-5884
email: opa@esd.ny.gov

A directory of certified minority and women-owned business enterprises is available from:

NYS Department of Economic Development
Division of Minority and Women's Business Development
633 Third Avenue
New York, NY 10017
212-803-2414
email: mwbecertification@esd.ny.gov
<https://ny.newnycontracts.com/FrontEnd/VendorSearchPublic.asp>

The Omnibus Procurement Act of 1992 requires that by signing this bid proposal or contract, as applicable, Contractors certify that whenever the total bid amount is greater than \$1 million:

(a) The Contractor has made reasonable efforts to encourage the participation of New York State Business Enterprises as suppliers and subcontractors, including certified minority and women-owned business enterprises, on this project, and has retained the documentation of these efforts to be provided upon request to the State;

(b) The Contractor has complied with the Federal Equal Opportunity Act of 1972 (P.L. 92-261), as amended;

(c) The Contractor agrees to make reasonable efforts to provide notification to New York State residents of employment opportunities on this project through listing any such positions with the Job Service Division of the New York State Department of Labor, or providing such notification in such manner as is consistent with existing collective bargaining contracts or agreements. The Contractor agrees to document these efforts and to provide said documentation to the State upon request; and

(d) The Contractor acknowledges notice that the State may seek to obtain offset credits from foreign countries as a result of this contract and agrees to cooperate with the State in these efforts.

21. RECIPROCITY AND SANCTIONS PROVISIONS.

Bidders are hereby notified that if their principal place of business is located in a country, nation, province, state or political subdivision that penalizes New York State vendors, and if the goods or services they offer will be substantially produced or performed outside New York State, the Omnibus Procurement Act 1994 and 2000 amendments (Chapter 684 and Chapter 383, respectively) require that they be denied contracts which they would otherwise obtain. NOTE: As of May 15, 2002, the list of discriminatory jurisdictions subject to this provision includes the states of South Carolina, Alaska, West Virginia, Wyoming, Louisiana and Hawaii. Contact NYS Department of Economic Development for a current list of jurisdictions subject to this provision.

22. COMPLIANCE WITH NEW YORK STATE INFORMATION SECURITY BREACH AND NOTIFICATION ACT.

Contractor shall comply with the provisions of the New York State Information Security Breach and Notification Act (General Business Law Section 899-aa; State Technology Law Section 208).

23. COMPLIANCE WITH CONSULTANT DISCLOSURE LAW.

If this is a contract for consulting services, defined for purposes of this requirement to include analysis, evaluation, research, training, data processing, computer programming, engineering, environmental, health, and mental health services, accounting, auditing, paralegal, legal or similar services, then, in accordance with Section 163 (4-g) of the State Finance Law (as amended by Chapter 10 of the Laws of 2006), the Contractor shall timely, accurately and properly comply with the requirement to submit an annual employment report for the contract to the agency that awarded

the contract, the Department of Civil Service and the State Comptroller.

24. PROCUREMENT LOBBYING. To the extent this agreement is a "procurement contract" as defined by State Finance Law Sections 139-j and 139-k, by signing this agreement the contractor certifies and affirms that all disclosures made in accordance with State Finance Law Sections 139-j and 139-k are complete, true and accurate. In the event such certification is found to be intentionally false or intentionally incomplete, the State may terminate the agreement by providing written notification to the Contractor in accordance with the terms of the agreement.

25. CERTIFICATION OF REGISTRATION TO COLLECT SALES AND COMPENSATING USE TAX BY CERTAIN STATE CONTRACTORS, AFFILIATES AND SUBCONTRACTORS.

To the extent this agreement is a contract as defined by Tax Law Section 5-a, if the contractor fails to make the certification required by Tax Law Section 5-a or if during the term of the contract, the Department of Taxation and Finance or the covered agency, as defined by Tax Law 5-a, discovers that the certification, made under penalty of perjury, is false, then such failure to file or false certification shall be a material breach of this contract and this contract may be terminated, by providing written notification to the Contractor in accordance with the terms of the agreement, if the covered agency determines that such action is in the best interest of the State.

26. IRAN DIVESTMENT ACT. By entering into this Agreement, Contractor certifies in accordance with State Finance Law §165-a that it is not on the "Entities Determined to be Non-Responsive Bidders/Offerers pursuant to the New York State Iran Divestment Act of 2012" ("Prohibited Entities List") posted at:
<http://www.ogs.ny.gov/about/regs/docs/ListofEntities.pdf>

Contractor further certifies that it will not utilize on this Contract any subcontractor that is identified on the Prohibited Entities List. Contractor agrees that should it seek to renew or extend this Contract, it must provide the same certification at the time the Contract is renewed or extended. Contractor also agrees that any proposed Assignee of this Contract will be required to certify that it is not on the Prohibited Entities List before the contract assignment will be approved by the State.

During the term of the Contract, should the state agency receive information that a person (as defined in State Finance Law §165-a) is in violation of the above-referenced certifications, the state agency will review such information and offer the person an opportunity to respond. If the person fails to demonstrate that it has ceased its engagement in the investment activity which is in violation of the Act within 90 days after the determination of such violation, then the state agency shall take such action as may be appropriate and provided for by law, rule, or contract, including, but not

limited to, imposing sanctions, seeking compliance, recovering damages, or declaring the Contractor in default.

The state agency reserves the right to reject any bid, request for assignment, renewal or extension for an entity that appears on the Prohibited Entities List prior to the award, assignment, renewal or extension of a contract, and to pursue a responsibility review with respect to any entity that is awarded a contract and appears on the Prohibited Entities list after contract award.



Corrections and Community Supervision

Request for Proposals 2016-02

For an Inmate Telephone System

November 2016

Notice to Bidders

1. Read the entire Request for Proposal (RFP) document. Note the key issues such as event dates, mandatory requirements, and proposal packaging requirements.
2. The successful bidder must meet all of the mandatory requirements. **Only one contract will result from this RFP.**
3. Bidders are permitted to communicate with the designated contacts **only**. Note the names and contact information for these contacts ([Section 1.6](#)).
4. Any amendments, transcripts, clarifications, responses to questions, and updates to this RFP will be posted on the NYS Contract Reporter (www.nyscr.ny.gov) and the DOCCS Web site (<http://www.doccs.ny.gov/RFPs/rfps.html>).
5. To submit a proposal, bidders must attend the mandatory Bidders' Conference ([Section 2.6](#)).
6. Take full advantage of the Questions and Answers opportunities. All questions must be submitted in writing to the designated email address by the date and time specified in [Section 1.7, Schedule of Events](#).
7. Bidders' proposals must address all amendments, clarifications, or updates pertaining to this solicitation document.
8. Review the RFP document and your proposal. Make sure all requirements are addressed and all submission copies are identical and complete.
9. Complete and submit with your proposals all required forms. Use the Bidders' Check list in Attachment C. All required forms are either included or links are provided for the latest revised documents.
10. Package your proposals as instructed in [Section 9.3](#).
11. Submit your proposals so that they are received by the designated due date and time (see [Section 1.7](#)). **DOCCS will not consider proposal submissions that arrive after the time specified on the due date.**

Table Of Contents

1	INTRODUCTION.....	1
1.1	DEPARTMENT OF CORRECTIONS AND COMMUNITY SUPERVISION (DOCCS) MISSION STATEMENT.....	1
1.2	BACKGROUND	1
1.3	OVERVIEW OF EXISTING INMATE TELEPHONE SYSTEM (ITS).....	2
1.4	PURPOSE	2
1.5	ISSUING AGENCY	3
1.6	DESIGNATED CONTACTS	3
1.7	SCHEDULE OF EVENTS	4
2	BIDDER INFORMATION.....	5
2.1	TERM OF AGREEMENT	5
2.2	COMPLETENESS OF PROPOSAL	5
2.3	MODIFICATIONS OF BIDS	5
2.4	WITHDRAWAL OF BIDS	5
2.5	INCURRING COSTS	5
2.6	MANDATORY BIDDERS’ CONFERENCE	5
2.7	PRIME CONTRACTOR RESPONSIBILITY	6
2.8	BEST VALUE.....	6
2.9	TERMS/DEFINITIONS.....	6
2.10	NYS AND DOCCS POLICIES	7
3	SCOPE OF SERVICES.....	8
3.1	SYSTEMS ARCHITECTURE.....	8
3.1.1	Proposed Deployment Model.....	8
3.1.2	Scalability	8
3.1.3	Network Services.....	8
3.1.4	System Trunking.....	9
3.1.5	Call Quality	9
3.1.6	Continuity of Services.....	9
3.1.6.1	Backup	9
3.1.6.2	Uninterruptible Power	9
3.1.7	Single Clock Source	9
3.1.8	Recording and Monitoring.....	9
3.1.8.1	Investigative Support	10
3.1.8.2	Simultaneous Access.....	10
3.1.8.3	Storage.....	10
3.1.8.4	Chain of Evidence.....	10
3.1.8.5	Retrieval	10
3.1.8.6	Equipment and Network Access	11
3.1.8.7	Access to Recordings	11
3.1.8.8	Call Monitoring Suppression	11

Table Of Contents

3.2	SYSTEMS MANAGEMENT	11
3.2.1	Fault Management.....	11
3.2.2	Configuration Management.....	12
3.2.2.1	Provisioning and Active Directory	12
3.2.3	Accounting Management	12
3.2.3.1	Third Party Auditing	12
3.2.3.2	Call Detail Records (CDR)	12
3.2.4	Performance Management	12
3.3	MANDATORY FUNCTIONS.....	12
3.3.1	Alert Groups	13
3.3.2	Pre-recorded Names	13
3.3.3	Access to Rape Crisis Programs	13
3.3.4	Access to Toll-Free Assistance Lines	14
3.3.5	Announcements.....	14
3.3.6	Automatic Number Identification	14
3.3.7	Billing Name and Address Lookup	14
3.3.8	Class of Restriction (COR).....	15
3.3.9	Investigative tip line	15
3.4	MANDATORY FEATURES	15
3.4.1	Harassment Blocks.....	15
3.4.2	Call Termination	15
3.4.3	Number Control	16
3.4.4	Personal Allowed Numbers (PAN)	16
3.4.5	Phone Scheduler	16
3.4.6	Personal Identification Number (PIN).....	16
3.4.7	Administration.....	16
3.4.8	Third Party Call Detection	16
3.4.9	Hours of Operation	16
3.4.10	Call Duration.....	16
3.4.11	Telephone Testing	16
3.4.12	Languages.....	17
3.4.13	ANI Verification.....	17
3.4.14	Telecommunications Relay Services for the Deaf	17
3.4.15	Telephone Accommodations for the Visually Impaired.....	17
3.4.16	Call Pattern Analysis and Alerting.....	17
3.4.17	Voice Recognition, Identification, and Analysis	17
3.4.18	Emergency Shut Down	18
3.5	EQUIPMENT	18
3.5.1	Telephones.....	18
3.5.2	Portable Phones	18
3.5.3	Pedestal and Enclosures	19
3.5.4	Tablets	19
3.5.4.1	Device Specifications.....	19
3.5.5	Wiring	19
3.5.6	Compliance	20

Table Of Contents

3.5.7	Restoration of Facilities	20
3.5.8	Inventory.....	20
3.5.9	Environmental.....	20
3.5.10	Servers and Processors	20
3.5.11	New Equipment	20
3.6	SOFTWARE ENHANCEMENTS AND UPGRADES.....	20
3.7	MAINTENANCE	21
3.7.1	Maintenance Responsibility	21
3.7.2	Damage.....	21
3.7.3	Maintenance Window	21
3.7.4	Maintenance Center Location	21
3.7.5	Maintenance Staff Experience	21
3.7.6	Preventive Maintenance	21
3.7.7	Remedial Maintenance	22
3.7.8	Maintenance Request Reports	22
3.8	TRANSITION/MIGRATION	22
3.8.1	Project Management.....	22
3.8.1.1	Project Manager	23
3.8.1.2	DOCCS' Resources.....	23
3.8.1.3	Site Survey	23
3.8.2	Call Recording Migration	23
3.8.3	Fallback Plan.....	23
3.8.4	Acceptance Testing	23
3.8.5	Equipment Disposal.....	23
3.9	DATA EXCHANGE	24
3.9.1	National Information Exchange Model (NIEM) Standards	24
3.9.2	Data Reconciliation.....	24
3.10	INFORMATION OWNERSHIP	24
3.11	SECURITY	24
3.11.1	ITS System Security	24
3.11.2	Jurisdiction	24
3.11.3	Compliance	25
3.11.4	Background Checks.....	25
3.11.5	Information Security Breach.....	25
3.12	PHASE-OUT PLAN.....	25
3.13	TRAINING.....	25
3.14	DOCUMENTATION.....	25
3.15	REPORTING	26
4	CUSTOMER SERVICE	27
4.1	SUPPORT SERVICES FOR DOCCS	27
4.1.1	Principal Technical Support Representatives.....	27
4.1.2	Toll-Free Access.....	27
4.1.3	DOCCS' Authorized Representatives	27
4.1.4	Gate Clearance	27
4.1.5	Ticketing System	27
4.1.6	DOCCS' Access to Customer Information	27
4.1.7	Court Evidence and Expert Witness Testimony	28

Table Of Contents

4.2	SUPPORT SERVICES FOR CUSTOMERS	28
4.2.1	Toll-Free Access.....	28
4.2.2	Executive Order Number 26	28
4.2.3	Customer Account Access.....	28
4.2.4	Customer Outreach	28
4.2.5	Call Blocking.....	28
4.2.6	Vendor Account Policies.....	29
4.2.7	Vendor Policy Changes	29
4.2.8	Aggregated Billing Account for DOCCS-Approved Organizations	29
5	PERFORMANCE STANDARDS	30
5.1	SERVICE OBJECTIVES	30
5.1.1	Facility Service Objectives.....	30
5.1.2	Customer Service Objectives.....	30
5.2	RESOLUTION OF REPORTED PROBLEMS	31
5.2.1	Failure to comply	32
5.2.2	Escalation Requirements.....	32
5.3	PERFORMANCE REVIEWS	33
6	VENDOR QUALIFICATIONS.....	34
6.1	COMPANY EXPERIENCE.....	34
6.2	PAST PERFORMANCE	34
6.2.1	Security Incidents	34
6.2.2	Performance Data	34
6.2.3	Legal Validity	34
6.3	STAFF QUALIFICATIONS	34
6.3.1	Staffing Numbers and Qualifications.....	35
6.3.2	Staff Disqualification	35
6.3.3	Staff Resignation or Discharge	35
6.4	VENDOR RESPONSIBILITY	35
6.4.1	Vendor Responsibility Requirements	35
6.4.2	Complaint History	36
7	RATES, FEES AND COSTS.....	37
7.1	NO COMMISSIONS	37
7.2	RATE STRUCTURE.....	37
7.2.1	Domestic	37
7.2.2	International.....	37
7.2.3	Rate Requirements.....	37
7.2.4	Ancillary Service Charges.....	37
7.2.5	Calling Patterns	37
7.3	BILLING.....	38
7.3.1	Collect and Prepaid	38
7.3.2	NYS DOCCS Liability	38
7.4	FINANCIAL STABILITY	39

Table Of Contents

8	CONTRACTUAL ISSUES	40
8.1	APPENDIX A / ORDER OF PRECEDENCE	40
8.2	ETHICS COMPLIANCE	40
8.3	PROCUREMENT LOBBYING ACT	40
8.4	SALES AND COMPENSATING USE TAX CERTIFICATION REQUIREMENTS	40
8.5	ENCOURAGING THE USE OF NYS BUSINESS	41
8.6	DIVERSITY PRACTICES	41
8.7	M/WBE AND EEO REQUIREMENTS	41
8.8	USE OF SERVICE-DISABLED VETERAN-OWNED BUSINESS ENTERPRISES IN CONTRACT PERFORMANCE ...	41
8.9	INDEMNIFICATION	42
8.10	CONTRACTOR INSURANCE REQUIREMENTS	42
8.11	CONSULTANT DISCLOSURE REPORTING REQUIREMENTS	48
8.12	FREEDOM OF INFORMATION LAW/TRADE SECRETS	49
8.13	EXECUTIVE ORDER NUMBER 26.....	49
8.14	EXECUTIVE ORDER 38.....	49
8.15	PERFORMANCE/PAYMENT BOND REQUIREMENT	50
8.16	LICENSED OR PATENTED COMPONENTS	50
8.17	PERPETUAL LICENSE	50
8.18	ESCROW OF SOFTWARE	50
8.19	BREACH OF SERVICES	50
8.20	GENERAL REQUIREMENTS.....	50
8.21	EQUIPMENT AND LICENSES UPON TERMINATION.....	51
8.21.1	Agency Termination.....	52
8.21.2	Procurement Lobbying Termination	52
8.22	CONTRACT TERMS	52
8.23	NONDISCLOSURE AGREEMENT	52
8.24	CONTRACT PROVISIONS	53
8.25	POTENTIAL ANNUAL REVENUE PAYMENTS	53
8.26	INMATE SECURE MESSAGING OPTION	53
9	ADMINISTRATIVE PROCEDURES	54
9.1	COMMUNICATION WITH DOCCS.....	54
9.2	PROCUREMENT RIGHTS.....	54
9.3	PROPOSAL FORMAT, PACKAGING, AND SUBMISSION INSTRUCTIONS.....	54
9.3.1	Proposal Content.....	56
9.3.2	Other legal documents (required but not subject to pass/fail disqualification):	56
9.3.3	Technical Proposal	56
9.3.4	Cost Proposal.....	57
9.3.5	Diversity Practices Questionnaire	57
9.4	PROPOSAL EVALUATION	57
9.4.1	Mandatory Requirements (Pass/Fail).....	57
9.4.2	Technical Evaluation (95 points)	57
9.4.3	Cost Evaluation (5 points).....	58
9.4.4	Composite Scores	58
9.4.5	Debriefings	58

Appendices And Attachments

APPENDIX A	STANDARD CLAUSES FOR NEW YORK STATE CONTRACTS
APPENDIX B	GENERAL SPECIFICATIONS
APPENDIX C	M/WBE FORMS AND INFORMATION
APPENDIX D	SAMPLE CONTRACT
APPENDIX E	VENDOR RESPONSIBILITY INFORMATION
APPENDIX F	VENDOR REFERENCE FORM
APPENDIX G	STAFF QUALIFICATION FORM
APPENDIX H	COST PROPOSAL FORM
APPENDIX I	NON-DISCLOSURE AGREEMENT
APPENDIX J	NOTICE INTENT TO BID & PRE-REGISTRATION BIDDERS' CONFERENCE
APPENDIX K	PROPOSAL RESPONSE FORMS
APPENDIX L	PERFORMANCE/PAYMENT BOND: SAMPLE BOND
APPENDIX M	DIVERSITY PRACTICES QUESTIONNAIRE
ATTACHMENT A	MAP OF NYS CORRECTIONAL FACILITIES
ATTACHMENT B	NYS DOCCS POPULATION AND PHONE DETAIL
ATTACHMENT C	PROPOSAL SUBMISSION CHECKLIST AND REQUIRED DOCUMENTS
ATTACHMENT D	DATA EXCHANGE SPECIFICATIONS
ATTACHMENT E	RANGE OF ACADEMIC CAPABILITIES FOR TABLETS

1 Introduction

1.1 Department of Corrections and Community Supervision (DOCCS) Mission Statement

Vision

Enhance public safety by having incarcerated persons return home under supportive supervision less likely to revert to criminal behavior.

Mission Statement

To improve public safety by providing a continuity of appropriate treatment services in safe and secure facilities where all inmates' needs are addressed and they are prepared for release, followed by supportive services for all parolees under community supervision to facilitate a successful completion of their sentence.

Goals

- Create and maintain an atmosphere where all inmates, parolees, staff, volunteers and visitors feel secure.
- Develop and implement individualized treatment plans for each inmate and parolee that includes post release reentry plans.
- Teach inmates and parolees the need for discipline and respect, and the importance of developing a principled work ethic.
- Establish a risks/needs/responsivity approach to programming, treatment, and community supervision to ensure a continuity of services.
- Assist all staff by providing the requisite training and resources needed to perform their duties while enhancing their skills.
- Offer career development opportunities for all staff.
- Ensure workforce stability through mentoring and succession planning.

Values

- Operate with ethical behavior.
- Recognize the value of each person.
- Protect human dignity.
- Offer leadership and support to all.
- Offer respect and structure at all times.

Policies

- Offer opportunities for inmates and parolees to improve their skills, and to receive individual treatment services, based on their ability and willingness to participate.
- Provide psychiatric and medically necessary services to those requiring such care and treatment so that each inmate and parolee can maximize his/her own state of health and rehabilitation.
- Provide a level of community supervision based on the releasee's needs and behavior.
- Establish an orderly and productive environment that fosters respect through open communication, sound structure and fair treatment.

1.2 Background

DOCCS utilizes a wide range of centralized services to support the Department's staff at 54 correctional facilities and other central office or regional sites. These functions are provided primarily through the NYS Office for Information Technology Services (OITS), which serves as a single point of contact for facility telecommunications and networking needs and uses its aggregated purchasing

capability to enhance facility operations on behalf of DOCCS. These services include but are not limited to the following:

- Telecommunications
- Data Communications
- Cabling and Infrastructure
- Mainframe and Citrix Applications
- Video Teleconferencing
- Inmate Telephone Systems
- Customer Service Desk
- Desktop Support & Administration
- Server Administration
- User and Account Provisioning

1.3 Overview of Existing Inmate Telephone System (ITS)

Pursuant to New York State Correction Law, Section 623, DOCCS and its current ITS service provider collectively manage the Inmate Call Home Program, which allows inmates to place telephone calls to family and friends. The current ITS supporting the Inmate Call Home Program is a customized network comprised of premise-based communication equipment and a single centralized call processing and data collection and storage devices. The system supports approximately 3,685 inmate telephones ranging from installations with as few as four (4) telephones to facilities with as many as 180. A list of the DOCCS' locations and the number of phones supported in each may be found in Attachment B. The telephone instruments are wired with standard category three cables. DOCCS does not guarantee the number of facilities or other locations or the number of phones at any of the facilities or other locations.

DOCCS maintains mainframe applications that provide authorized staff with administrative functions and tools that allow the DOCCS' Guidance staff the ability to maintain individual inmate calling lists. Each inmate is allowed to place collect or pre-paid calls between the hours of 7:00 a.m. and 11:00 p.m. ET to any of the fifteen (15) telephone numbers appearing on their personal allowed list for a maximum duration of thirty minutes per call. In a six-month period, the ITS processed approximately 7.7 million calls totaling nearly 112 million minutes of traffic.

DOCCS desires to contract for a comprehensive, full featured ITS that will serve all New York State Correctional Facilities, inmates and their families, and will support related administrative and investigatory activities. DOCCS' intent is to implement an enterprise ITS solution that can be deployed statewide and managed as a single platform to provide pre-paid and collect calling. The goal is to smoothly migrate from the existing ITS to a new system within ninety (90) calendar days of the contract approval and with no disruption of service.

1.4 Purpose

The purpose of this Request for Proposals (RFP) is to solicit proposals that will lead to a contract with a responsive and qualified vendor for a new inmate telephone system that offers the lowest possible rate for inmates and their families and provides DOCCS with the following scope of services:

- Project management and implementation services to assure a timely execution of the procured services and the migration and integration of existing information
- Administrative, operational and support services necessary for the ITS to fulfill DOCCS requirements and service levels
- Migration from the current system, services and equipment to the new ITS
- Operation of a secure, high availability environment
- Provisioning, deployment, and ongoing support of all equipment including telephony devices, servers, communication components, monitoring workstations and any circuits and related hardware and software that provide for a fully functioning system
- An operational environment that will assure that all information provided by the State will at all times reside within the United States only
- Operational procedures, training, tools and documentation necessary to operate, backup, recover and administer the ITS services

- Necessary staffing and support facilities to operate and maintain the ITS and meet the required service levels including a dedicated Program Manager
- Interfaces to receive and provide information between the ITS and DOCCS' internal applications services
- Customer service support to meet the needs of DOCCS' inmates, families and friends, and authorized system users

1.5 Issuing Agency

The issuing agency of this RFP is the New York State Department of Corrections and Community Supervision (DOCCS). This RFP outlines the terms and conditions as well as all applicable information required for submitting a bid. Bidders must strictly adhere to the bid submission date and time provided in [Section 1.7](#) to prevent disqualification.

1.6 Designated Contacts

All inquiries concerning this RFP must be addressed in writing to the DOCCS' designated contact as follows:

Designated Contact

Velma Berry

Email: doccscontracts@doccs.ny.gov

Phone: (518) 436-7886 extension 3135

Fax: (518) 436-1519

Alternate Contact

Frank Arpey

Email: doccscontracts@doccs.ny.gov

Phone: (518) 436-7886 extension 3135

Fax: (518) 436-1519

All inquiries must be submitted by email or written document to the designated contact(s). Please use *RFP 2016-02* in the subject line and specify the location (particular section and paragraph) of this RFP. Bidders are responsible for ensuring delivery of their questions.

All bidders must develop technical and cost proposals that reflect the terms of the contract provisions described in this RFP. All clarifications and exceptions including those relating to the terms and conditions of the proposed contract are to be resolved prior to the submission of a proposal. Answers to all questions of a substantive nature will be given to all bidders in the form of a formal addendum, and this addendum will be annexed to and become a part of the resulting contract.

1.7 Schedule of Events

Event	Day	Date
Release of RFP	Wednesday	11/9/16
Registration for Bidders' Conference Due (Appendix J)	Friday	12/2/16
Mandatory Bidders' Conference	Thursday	12/8/16
Final Written Questions Due from Bidders	Friday	12/16/16
Official Response to Bidders' Questions	Thursday	1/5/16
Closing Date for Receipt of Proposals (proposals must be received by 3:00 p.m.)	Thursday	1/19/17
Bid Opening Date	Tuesday	1/24/17
Onsite or Real-Time Demonstration	TBD	2/17 – 2/26/17
Selection of Contractor	Wednesday	3/1/2017
Contract Signed by DOCCS and Contractor	Wednesday	3/22/2017
Contract Award (Office of the State Comptroller Approval)	Friday	6/30/2017
Project Initiation Meeting	Wednesday	7/5/2017
Implementation Complete	Monday	10/2/2017

NOTE: This is a tentative timetable, which may ONLY be modified to address the State's needs.

END OF SECTION 1: INTRODUCTION

2 Bidder Information

2.1 Term of Agreement

The Agreement shall run for five (5) years beginning October 1, 2017, through September 30, 2022, contingent on approval of the Office of the State Comptroller (OSC). DOCCS reserves the sole right to renew the Agreement for two additional one-year periods under the same terms and rates by notifying the contractor of its intention no less than one-hundred-eighty (180) days before the expiration of the original Agreement or the initial one year renewal period.

DOCCS reserves the right to seek a refresh of any or all equipment and/or software provided or maintained as a result of this RFP after the fourth year of this agreement.

DOCCS reserves the right to seek reduced rates and/or new terms of agreement from the contractor prior to any extension.

2.2 Completeness of Proposal

Bidders must submit proposals describing the complete range of services specified in this RFP. It is the responsibility of the bidder to verify the completeness of its proposal and its suitability to meet the requirements of this RFP. Proposals that fail to meet the mandatory requirements will be disqualified.

2.3 Modifications of Bids

Once submitted, proposals may not be modified unless DOCCS specifically requests a clarification or explanation. Any clarification or explanation submitted by a bidder shall be done so in written form only. Modifications submitted by a bidder after the formal submission date that are not in response to a written request from DOCCS shall not be accepted.

2.4 Withdrawal of Bids

Bids cannot be withdrawn for a minimum of 120 days after the bid submission date (see State Finance law Section 163.9(e).) Written requests to withdraw proposals after the 120-day period may be granted only with written permission from DOCCS.

2.5 Incurring Costs

DOCCS shall not be held liable for any costs incurred by the bidder in the preparation, production or submission of a proposal, or for any work performed by a bidder prior to the approval of an award Agreement.

DOCCS shall not be held liable for any costs incurred by a bidder for the bidder's requirement to attend the mandatory Bidders' conference to be held at the location specified in Section 2.6.

DOCCS shall not be held liable for any costs incurred by a bidder in modifying or explaining details of the bidder's proposal in response to questions from DOCCS.

DOCCS shall not be held liable for any costs incurred by a bidder for any negotiations with DOCCS required to finalize and sign a formal Agreement document.

2.6 Mandatory Bidders' Conference

Bidders intending to submit a proposal shall be required to attend a mandatory bidders' conference to be held on the day indicated in Section 1.7, *Schedule of Events*, at DOCCS Training Academy, 1134 New Scotland Road, Albany, NY 12208, beginning at 1:00 p.m. ET. **Only bidders who attend the mandatory bidders' conference will be qualified to submit proposals.**

All attendees **must** be preregistered to be admitted to the mandatory bidders' conference and must present U.S. government or state issued picture identification. Bidders must preregister at least two (2) business days prior to the conference date by completing **Appendix J** and emailing the form to

the address specified in [Section 1.6](#). It is the responsibility of all bidders to ensure proper delivery of the emailed notices.

Bidders should email all questions to be considered at the Bidders' Conference to the designated contacts identified in [Section 1.6](#) no later than one (1) business day prior to the conference. A list of all questions sent in by all interested parties may be made available at the start of the mandatory bidders' conference.

Questions not submitted prior to the mandatory bidders' conference may be answered at the conference only if DOCCS believes doing so would be in the best interest of the State.

All answers provided for written questions at the mandatory bidders' conference shall be supplied to all attendees in writing by the due date for the Official Response to Bidders' Questions ([Section 1.7](#)). All responses provided at the bidders' conference will be unofficial until issued in written form. All subsequent questions must be submitted in writing by the due date in [Section 1.7, Schedule of Events](#). Answers to all questions and a copy of the Bidders' Conference transcript will be posted on the NYS Contract Reporter and the DOCCS' Web site no later than the date published in [Section 1.7](#). If there is a conflict between the Official Responses to the Questions and the transcript from the Bidders' Conference, the Official Responses will take precedence.

2.7 Prime Contractor Responsibility

Bidders may submit a proposal utilizing the services of subcontractors for any aspect of this procurement; the prime contractor must assume complete responsibility and liability for the delivery of all services. Subcontractors may be used to meet the qualifications required herein; however, subcontractors must be fully disclosed in the same manner as required of the prime contractor and must provide the same information including *Vendor Responsibility Questionnaires* company finances and staff qualifications. The roles and responsibilities of each proposed subcontractor must be clearly delineated in the bidder's response to [Section 3.1.1, Proposed Deployment Model](#), and bidders should inform all subcontractors that references for the related areas of service must be provided as indicated in [Section 6.1, Company Experience](#).

2.8 Best Value

The contract resulting from this RFP will be awarded to the qualified bidder whose proposal is determined to provide the best value to the State as defined in NYS Finance Law § 163.

2.9 Terms/Definitions

The terms *shall*, *must*, and *will* designate mandatory requirements. If a Bidder fails to meet **any** of these requirements they will be disqualified from further consideration.

The terms *bidder*, *vendor*, *contractor*, and *provider* are used interchangeably herein and shall have the same meaning.

The name of this agency, NYS Department of Corrections and Community Supervision, is used interchangeably herein with *Department* and *DOCCS*.

The following is an incomplete listing of definitions for acronyms:

Acronym	Definition of Acronym
ANI	Automatic Number Identification
DIN	Department ID Number
DTMF	Dual Tone Multi-Frequency
ET	Eastern Time
FTP	File Transmission Protocol
NIEM	National Information Exchange Model
PIN	Personal Identification Number
RPO	Recovery Point Objective
RTO	Recovery Time Objective
TN	Terminating Number
WAV	Waveform Audio File Format is a Microsoft and IBM audio file format standard for storing an audio bitstream on PCs

2.10 NYS and DOCCS Policies

The Bidder must agree to comply with all applicable New York State and DOCCS policies, procedures, regulations and directives throughout the term of the contract. Any individual hired by the Contractor to work in the facilities, by virtue of accepting his/her assignment, must abide by all the policies, rules and regulations of the Department.

Each individual staff member providing services in a correctional facility should be made aware of and agree to the following Department Directives, as currently written, or as revised:

- #2216 - Fingerprinting/Criminal History Inquiry - New Employees and Contractors
- #4936 - Search of Department Employee
- #4900 - Security in the Gate Area

The directives will be available to the selected vendor once the contract resulting from this solicitation is approved by the Office of the State Comptroller.

In addition, the Contractor will be familiar with and provide staff with information in federal and NYS Laws as well as Department Policy on the Prevention of Sexual Abuse of Inmates:

<http://www.doccs.ny.gov/PREA/PREAINfo.html>

It is the responsibility of the Contractor to see that all employees are aware of the directives cited above and all other applicable rules and regulations of the Department. Copies of all relevant parts of the Department's Employee Rule Book will be made available to the Contractor.

END OF SECTION 2: BIDDER INFORMATION

3 Scope of Services

This section provides information for the required features, functions and capabilities of the proposed services. All of the items identified in this section should be at no additional cost to DOCCS.

The bidder must describe all of the required features, functions and capabilities of the proposed services including how the features are expected to function and the expected performance levels for each feature.

New York State will not be a test site for unproven technology. For all technology proposed, your references must include at least two sites where this technology has been in service as an integrated part of the inmate phone system for at least six (6) months. An onsite or real-time demonstration of the technology must be provided prior to finalization of the scoring for this procurement.

3.1 Systems Architecture

Any proposed architecture must meet the general business needs of DOCCS and will be considered and evaluated for its relative merit. Bidders may propose an architecture that is fully hosted, partially hosted, centralized, distributed, or any combination thereof.

Provide information on your proposed system architecture addressing each subsection and request under Section 3.1.

3.1.1 Proposed Deployment Model

Describe in detail the proposed solution's deployment model.

Include in your response a detailed drawing of your recommended model in Microsoft Visio format, and

- **Illustrate how the proposed system will provide 99.9% yearly availability.**
- **Describe the reliability of your offerings and indicate how your solution will provide 99.9% availability.**
- **Indicate any single points of failure within your solution.**
- **Describe any vendor partnerships required to make the system fully functional and the system component(s) each party is responsible for operating and maintaining.**
- **Indicate why your proposed deployment model is superior over other architectures.**

3.1.2 Scalability

The contractor must be able to accommodate an increase in services during the term of the contract as directed by DOCCS at no increase in cost and continue to meet all service and performance requirements. The system must be able to incrementally increase to support a 50% increase in volume and/or end-user devices.

Describe how your solution will meet this requirement and what actions would be needed to fulfill the demand.

3.1.3 Network Services

Unless otherwise agreed to by DOCCS, the contractor shall replace all circuits required to provide connectivity from each location to the contractor's proposed services. Unless otherwise agreed to by DOCCS, no proposed solution shall utilize existing or future DOCCS' telecommunication services installed at DOCCS locations. The contractor must be the customer of record for all telecommunication services used to support the proposed solution.

3.1.4 System Trunking

The system must be engineered to ensure that all outbound calls are totally non-blocked. The solution proposed must reserve separate bandwidth or channels for each phone without impacting the required bandwidth for the operational characteristics of the system.

Describe how your solution will meet this requirement; detail the trunking requirements and the formula that will be used to fulfill the requirement.

3.1.5 Call Quality

The contractor shall be required to provide telephone reception quality at least equal to current reception quality levels and shall accept DOCCS' decision regarding such determination. If an IP based solution is proposed, the bidder must detail which codec will be utilized and substantiate a Mean Opinion Score (MOS) of no less than 3.9 for the chosen codec.

Describe how your solution will meet or exceed these requirements.

3.1.6 Continuity of Services

The vendor must provide sufficient redundancy and business continuity recovery capability to meet a three (3) hour Recovery Time Objective (RTO) and a zero (0) Recovery Point Objective (RPO) of all ITS components.

Describe how your solution provides operational redundancy, fault tolerance, and recovery so that services to DOCCS are not significantly diminished and that service levels, as defined in [Section 5](#), will continue to be met.

3.1.6.1 Backup

The vendor shall be responsible for performing all system and database back-ups and archiving. The vendor shall provide all archival hardware, supplies, and network and recovery procedures to ensure that no data will be lost.

The vendor must back up all DOCCS information and store copies securely off site in compliance with DOCCS security policies. Vendor must certify the availability and integrity of back-up data and the media on which it resides.

Describe how you will meet these requirements including frequency of backups, off-site location(s) and security of transfers.

3.1.6.2 Uninterruptible Power

The solution must assure no loss of ITS functions for a minimum of three (3) hours due to a loss of commercial power in the DOCCS' facilities. The vendor must provide an ITS capable of full recovery from a power outage automatically once commercial power is restored.

Describe how your solution will meet this requirement including what facilities and services DOCCS must provide.

3.1.7 Single Clock Source

The vendor shall ensure that inmate call processing equipment, call detail recording, and recorded conversations will be synchronized from a single time-of-day clock source for all of DOCCS' locations.

Describe how your solution will meet this requirement.

3.1.8 Recording and Monitoring

The system must provide undetected monitoring of real-time inmate conversations, store and replay of historical conversations with the option of storing to removable media, and the ability to

lock certain call recordings from deletion. These capabilities shall be provisioned to allow access to some or all features by unique user ID. (e.g. Facilities staff may only monitor calls in real time, while investigative staff have the full feature set.) All removable media must be encrypted. DOCCS is interested in understanding all features available for managing the recorded call search, playback, and copying processes.

Identify removable media to be provided and describe all features that will allow DOCCS to streamline and accelerate these functions and download selected recording(s) to external media if desired.

Describe how your solution will meet this requirement.

3.1.8.1 Investigative Support

The vendor shall provide live, real-time investigative analysis that allows authorized users employed by the vendor and by the Department to view and analyze a percentage of call data to establish links between selected inmates and called parties, to include activities such as gang, drug, victimization, extortion, and other nefarious activities.

The system should also be able to provide reports on call-pattern analysis and call-volume distortions in real time.

Describe the proposed system's ability to fulfill the real-time analysis requested above, the number of analysts, and the percentage of calls that will be analyzed.

3.1.8.2 Simultaneous Access

Recording or monitoring equipment may be centralized or hosted and shall have the capability of undetected recording of every completed inmate telephone call for the duration of that call. The vendor shall provide the ability and bandwidth for a minimum of 20 simultaneous users who can listen to any recording at one time at any facility or any combination of facilities while continuing to meet the requirements of [Section 3.1.4](#), *System Trunking*.

Describe how you intend to meet this requirement, explain whether the recording will be hosted or centralized, detail the bandwidth and equipment requirements required to meet this objective.

3.1.8.3 Storage

The vendor must store all call recordings and associated call detail records for twelve (12) months at no additional charge to DOCCS. All calls locked by DOCCS for investigative purposes shall be stored indefinitely by the contractor and remain available throughout the life of the contract period at no cost to DOCCS. At the end of the contract period, all locked calls will be turned over to the succeeding contractor without additional cost to DOCCS.

3.1.8.4 Chain of Evidence

The vendor must assure that the chain of evidence is protected when copying recordings to removable media and vendor must provide the software or tools necessary for playback.

Describe how you will provide this function and explain its capabilities.

3.1.8.5 Retrieval

The system shall permit authorized staff to attach textual descriptions or "notes" to each recorded call record allowing for descriptions of the recording. Each recording

must be indexed by date, time, Automatic Number Identification (ANI), Personal Identification Number (PIN), Terminating Number (TN), and textual “notes.” Date and time stamps shall be identical to the date and time stamps recorded in the system’s call detail records and call processing equipment. The recording must be searchable by date, time, inmate’s PIN, ANI, TN, “notes” or any logical combination thereof. Search and retrieval of recorded conversations shall take no longer than 20 seconds. Search and playback of calls will not require a manual media change.

Describe how your solution will meet or exceed these requirements.

3.1.8.6 Equipment and Network Access

Network access and all equipment or software required allowing DOCCS to monitor, retrieve, playback, and store recordings to removable media, or print local reports shall be provided by the vendor. All removable media must be encrypted by the proposed system. Any equipment to be deployed must be approved by DOCCS. DOCCS currently has approximately one workstation per facility and approximately 67 remote workstations with this capability. DOCCS reserves the right to add additional workstations at no additional cost to DOCCS.

Describe all alternative methods available to access and monitor live and recorded calls from portable devices, including but not limited to, laptops, tablets, and smart-phones. Include all system features available and all standard system features not available through these devices. Identify how access from these devices is authenticated, managed, identified and tracked and the security features associated with each type of access.

3.1.8.7 Access to Recordings

Access to live monitoring or recordings must be controlled by a multi-level password authentication that provides at least the following differentiating functionality:

- listening to live conversations only
- listening to live or recorded conversations with the ability to store to removable media

Describe how your solution will meet or exceed these requirements.

3.1.8.8 Call Monitoring Suppression

DOCCS desires the ability to disable real-time call monitoring of calls made to specific speed dial numbers (e.g. *77) or 10-digit numbers at the facility and system level. Disabling call monitoring must not prevent these calls from being recorded.

Describe how your solution can provide this capability.

3.2 Systems Management

The contractor must provide the following system management functions. Describe how your proposed solution meets each of the following requirements in this section.

3.2.1 Fault Management

The bidder’s solution must provide fault management capabilities that recognize, isolate, correct and log faults that occur in the system. The vendor must provide DOCCS with real time on-line notification of all systems alerts and alarms including the status of all incidents.

Describe the capabilities, functionality and visibility that DOCCS will have with your fault management offering and the functionality of your fault management solution.

3.2.2 Configuration Management

The vendor must provide configuration management capabilities that include the provisioning of devices, systems administration, gathering and storing of configuration data, managing version control, tracking and scheduling of changes, and the assignment of permissions to access system investigative features. Access to all system functions will be restricted to users authorized by DOCCS. Each authorized user must have a unique user-ID and password.

Describe the functionality of your configuration management solution, including the capabilities and functionality that DOCCS will have with your offering.

3.2.2.1 Provisioning and Active Directory

DOCCS provisions authorized users and applies permissions to investigative and control features on a case-by-case basis. The State's goal is to automate provisioning using role-based access stored within the State's Active Directory structure.

Describe how Active Directory may be leveraged to automate this function within your solution.

3.2.3 Accounting Management

The vendor must provide accounting management capabilities that at a minimum provide account verification and correction, billing assurance and reconciliation and tracing of customer payment, credit and call limit/blocking status and history. On a monthly basis, the vendor must provide a billing reconciliation file to DOCCS as described in Attachment D.

Describe the functionality of your solution, including the capabilities and functionality that DOCCS will have with your offering.

3.2.3.1 Third Party Auditing

DOCCS or its agent shall have the right to audit and review any aspects of the contractor's operations and systems including but not limited to data, documentation, procedures, billing, financial records, customer service statistics, staff backgrounds and anything related to the functioning, operations, costs, rates or integrity of the system.

3.2.3.2 Call Detail Records (CDR)

The vendor must provide all call detail records to DOCCS in a frequency and format as specified in Attachment D.

3.2.4 Performance Management

The vendor's solution must provide performance management capabilities to monitor the overall performance of the ITS and its network components.

Describe all of the following:

- How you will collect and analyze performance data, monitor system health and reliability, establish performance thresholds and provide reporting and inquiry functions.
- The frequency and types of reports available.
- The capabilities and functionality that DOCCS will have with your offering.

3.3 Mandatory Functions

For each function listed in this section, the bidder must describe in detail, and provide a detailed call-flow diagram where specified, illustrating how its proposed solution will meet DOCCS' requirements.

3.3.1 Alert Groups

The system shall allow authorized users the capability of flagging specific terminating numbers (TN) or personal identification numbers (PIN) to be placed on a watch list. When a call in progress is detected to/from any number on the watch list, the system shall optionally attempt to bridge the call with a pre-determined group of numbers to allow remote undetected monitoring of the call. The bridged party shall be informed of the origination PIN or TN and enter a security pass code to actively monitor the call.

- **Describe how your proposed solution will buffer or delay the monitored calls' audio to allow DOCCS' staff to hear the entire call.**
- **Explain how this buffer or delay can be adjusted and provide the parameters available for the adjustments.**
- **In addition to the written description, provide a call-flow diagram detailing the entire process from the time that the inmate goes off-hook through call termination.**

3.3.2 Pre-recorded Names

The system shall prompt the inmate to record his/her name when a PIN is first used. The system must provide the ability for an inmate to playback the recorded name and rerecord the name prior to accepting the recording. Once the recording is accepted, the inmate shall not have the ability to modify or erase the recording without action by DOCCS to review and delete the original recording. The recorded name shall be used in all subsequent announcements made to the called party.

3.3.3 Access to Rape Crisis Programs

The Department must enable reasonable communication between inmates and Rape Crisis Programs, in as confidential a manner as possible. Based upon the model currently being tested through a pilot program, the Department has entered into cooperative agreements with regional Rape Crisis Programs to permit direct telephone access from the inmate phone system, as well as follow-up services via staff assisted calls and legal visits. The Department anticipates building on this model, but must be flexible as providers change.

In the future, DOCCS anticipates continuation and expansion of a pilot project model that permits inmates to dial a speed dial (#77) to be routed to a designated Rape Crisis Program. DOCCS expects to designate additional numbers that can be direct dialed by any inmate either at selected facilities or at all facilities.

- A. The Department requires the ability to continue its current model of designating a destination number for a standardized speed dial. Inmates in any facility will be permitted to dial #77 and have their call routed to a predetermined Rape Crisis Program based upon the facility they are in at the time of the call.
 1. The Department requires the ability to change the destination number when providers change.
 2. Calls placed via #77 will be free of charge.
- B. In addition, the Department requires the ability to designate certain telephone numbers as "free" calls that can be dialed by any inmate at a designated facility or facilities, or at all facilities.
 1. Designated numbers may include direct dial (e.g., 518-xxx-xxxx) or toll free (e.g., 800-xxx-xxxx) numbers.

2. The Department needs the ability to add or delete individual numbers or groups of numbers from this list throughout the life of the contract.
- C. For all numbers (those associated with the #77 speed dials and other designated Rape Crisis Program telephone numbers), DOCCS requires the ability to indicate that call detail records should be suppressed from view at the facility level.
- D. The default for these numbers would be that both call detail information and monitoring at the facility level is suppressed. However, DOCCS should be able to independently change each of these rules for each telephone numbers. Call detail information will not be suppressed from certain Central Office level reports.

In all cases, calls are recorded and accessible to Central Office investigators (e.g., Office of Special Investigations).

3.3.4 Access to Toll-Free Assistance Lines

The Department requires the ability to designate certain telephone numbers as “free” calls (e.g. smokers’ quit line, substance abuse help line, etc.) that can be dialed by any inmate using an agreed upon speed dial number at a designated facility or facilities, or at all facilities.

Designated numbers may include direct dial (e.g., 518-xxx-xxxx or toll free 800-xxx-xxxx) numbers. The Department needs the ability to add or delete individual numbers or groups of numbers from this list throughout the life of the contract. The called number must be hidden from the inmate at all times.

3.3.5 Announcements

Upon delivery of the call, the system must clearly announce to the called party that the call is from a NYS Correctional Facility, the facility name, and the inmate’s pre-recorded name. The system shall allow the called party to optionally hear current rates and actively accept or deny the call by pressing a key on the touch-tone dial pad. The event shall be identified and recorded in call detail records.

In addition to a written description, provide a call-flow diagram detailing the entire process from the time that the inmate goes off-hook until call termination.

3.3.6 Automatic Number Identification

The Automatic Number Identifier (ANI) for all ITS calls must identify to the called party both New York State Department of Corrections and Community Services and the specific correctional facility name from which the call originated. DOCCS requires a unique ten-digit telephone number be used to identify each of its correctional facilities to the called party and, the ten-digit numbers used for ANI be phantom telephone numbers incapable of receiving incoming calls. The unique telephone station identifier (i.e. extension number, port assignment, or location) used to identify the individual ITS telephones within a facility must not be used as part of the ANI information transmitted to the called party.

Describe how this capability will be provided.

3.3.7 Billing Name and Address Lookup

The system shall allow authorized DOCCS’ staff to perform billing name and address lookup of the called party number using at a minimum the Local Exchange Carrier (LEC) Line Information Data Base (LIDB.)

Describe how this capability will be provided and any additional capabilities that are available.

3.3.8 Class of Restriction (COR)

The ability to apply restrictions to individual phones shall be based on a COR associated with each telephone. The vendor must support at a minimum the ability to restrict phones with the following levels:

Level	Pin	Action
Level 1	Required	Calling list required
		Disciplinary hold applies
Level 2	Required	Calling list required
		Disciplinary hold does not apply
Level 3	Required	Calling list not Required
		Disciplinary hold does not apply

Describe how this capability will be provided.

3.3.9 Investigative tip line

The system must permit future adoption of a “tip line” that permits a call to be placed from any inmate telephone and to leave a recorded message. The system must meet language access requirements, permit recorded messages to be transmitted to designated email addresses as WAV files, and permit remote access by designated users.

3.4 Mandatory Features

The following features are required elements for the DOCCS’ Inmate Telephone System.

Describe specifically how your proposed solution provides the same functionality for each of the following features.

3.4.1 Harassment Blocks

The system shall support the automatic denial of a PIN when a remote party refuses to accept a call. The called party must be provided with the option to either accept or block each call prior to being connected to the inmate.

Explain how your system accomplishes this and whether blocking can be done at the PIN, facility or system level; if all future calls from that PIN or facility are blocked; and what steps are required to unblock future calls.

3.4.2 Call Termination

The system shall allow authorized system users to instantly terminate a call in progress. The system must identify the event in call detail records and log the action separately identifying at a minimum the facility, date, time, PIN and the user-id of the individual terminating the conversation. The system must provide the ability for DOCCS to create ad-hoc reports detailing this activity by facility or system-wide at a minimum.

Provide details on the reporting capabilities.

3.4.3 Number Control

The system must provide the ability to block numbers globally (e.g. 800/900 numbers) while allowing individual telephone numbers within a blocked area code. DOCCS must be able to apply these blocks on a facility-by-facility and system-wide basis at a minimum.

3.4.4 Personal Allowed Numbers (PAN)

The system shall provide the ability to restrict inmate calling to a pre-approved list not to exceed 15 numbers. The list shall be refreshed and batch updated as specified in Attachment D.

The system must provide a telephone COR which allows calls to be placed from specific telephones without an active PAN list.

3.4.5 Phone Scheduler

The system shall provide the ability for DOCCS to make individual phones, groups of phones or the entire system active or inactive based upon on an independent schedule.

3.4.6 Personal Identification Number (PIN)

The system must provide the ability to force an eight (8) character Personal Identification Number (PIN) before processing a call. The proposed solution must validate the PIN number and inmate location prior to allowing each call. The DOCCS' list shall be refreshed and batch updated as specified in Attachment D.

3.4.7 Administration

The system must provide the ability to administer system functions and features including but not limited to inmate accounts, PINs, PANs, phone schedules and access through what is commonly referred to as access control lists. Access to functions and features will require separate permissions be associated with a unique user-id.

Describe in detail how the permissions-based access will operate and how many unique levels of access can be created. A minimum of four (4) levels is required; greater than four (4) levels is preferred.

3.4.8 Third Party Call Detection

Describe how the system detects an attempt to bridge a call in progress to a third party and provide options to disconnect the call, flag the call, or play a voice prompt warning. The event must be captured in call detail records.

3.4.9 Hours of Operation

The solution shall allow DOCCS to set parameters that determine the hours of operations for inmate phone services. The default shall be set to allow services to be available from 7:00 a.m. to 11:00 p.m. ET. At DOCCS direction, individual phones or groups of phones may be further restricted.

3.4.10 Call Duration

The system shall allow DOCCS to control the maximum call duration at each facility. Current call duration is one half (1/2) hour.

3.4.11 Telephone Testing

The vendor shall provide the ability to allow DOCCS staff to test telephones at any location, at no charge to DOCCS, to assure that they are fully operational. The vendor shall provide unique PINs with a DOCCS-defined PAN list to be used by DOCCS' staff when testing phones.

3.4.12 Languages

The system prompts will be available in all of the following languages: English, Spanish, Chinese, Russian, Haitian Creole, Korean, and Italian. (See [Section 4.2.2](#) for more information about required languages.) The selected Contractor will agree to support additional languages during the life of the resulting contract.

Describe how your proposed system is able to support other languages. Include all the languages that will be supported.

3.4.13 ANI Verification

The vendor shall test all inmate telephones for location accuracy and verify the Automatic Number Identifier (ANI) at implementation, during activation of new equipment and at a minimum, annually thereafter.

3.4.14 Telecommunications Relay Services for the Deaf

The vendor shall provide telecommunications relay devices for the deaf compliant with the Americans with Disability Act (ADA), and the Federal Communications Commission (FCC) and New York State Public Service Commission's (PSC) rules and regulations throughout the term of the agreement.

Explain how your solution can extend telecommunications services for inmates who are deaf or hard of hearing and all monitoring, recording and reporting capabilities that will be available with this service. Include details that show how the proposed plan will be in compliance with the ADA, the FCC and PSC rules and regulations at no additional cost to DOCCS or the account holders throughout the term of the agreement, recognizing that TTY technology will cease to be supported during the term of this agreement.

3.4.15 Telephone Accommodations for the Visually Impaired

The vendor must propose devices accessible to the visually impaired and that are compliant with the ADA, the FCC and the PSC rules and regulations throughout the term of the agreement. This functionality will be required at approximately 10 correctional facilities on phones that will be identified by the Department and may be changed from time-to-time at the Department's discretion.

Explain how your solution can extend telecommunications services to visually impaired inmates and all monitoring, recording and reporting capabilities that will be available with the services. Include details that show how the proposed plan will be in compliance with the ADA, and the FCC and PSC rules and regulations at no additional cost to DOCCS or the account holders throughout the term of the agreement, recognizing that TTY technology will cease to be supported during the term of this agreement.

3.4.16 Call Pattern Analysis and Alerting

The system shall provide the ability to identify trends within inmate calling patterns and issue an indicator to authorized personnel when pattern changes occur. DOCCS shall specify the alert thresholds.

Explain how your system can be utilized to perform this function, including, but not limited to, call-alerting parameters, which can be set by DOCCS; notification capabilities (real-time and historic); and reporting capabilities.

3.4.17 Voice Recognition, Identification, and Analysis

The system shall provide voice biometric authentication: It will create and store voice prints for all inmates and will compare the caller's voice to the stored voice print using a set of measurements and comparison methods at the beginning of the call. Calls attempted by an

inmate determined not to be the inmate of record will be disallowed, flagged accordingly, and reported through standard call detail reporting. Additionally, the inmate's voice will be monitored continuously throughout the call. The system should have the ability to detect an additional/different voice print on a call in progress, identify the inmate, flag the call, and report the occurrence through standard call detail reporting. The system will also have the ability to send a real-time alert to designated staff for specified inmates.

Required

Describe how the proposed system will provide for voice recognition, identification, and analysis including the following:

- A. A solution for verification of inmate identity via voice identification prior to call initiation**
- B. A solution for continuous monitoring and immediate detection and identification of additional/different voices during the entire call**
- C. A solution for providing real-time alerts for the detection of pre-identified inmates**

Describe how the solution will address voice analysis, voice stress analysis, and voice pattern analysis.

Optional/Desirable

- D. Describe any additional features if available with the proposed system including the ability to compare called parties by voice and identify potential matches for all inmate calls statewide.**

3.4.18 Emergency Shut Down

The system shall provide for the emergency shutdown of all phones in a facility or portion thereof at each facility and provide a master control in Central Office that cannot be overridden at a facility. Therefore, the system shall provide the ability to disconnect any phone or group of phones locally or remotely.

Describe in detail how this is accomplished.

3.5 Equipment

The vendor shall provide all equipment required to provide ITS services for all of the DOCCS' facilities and locations at no cost to DOCCS. All equipment must be described in the vendor's proposal. The vendor must propose equipment that is appropriate for a correctional facility environment. Upon successful installation, all telephones, pedestals, and wiring will become the property of DOCCS.

3.5.1 Telephones

All devices provided must be hearing aid compatible and include volume controls on the housing with a 24-inch hand set cable, and be appropriate for a correctional facility environment. The devices provided must be equivalent to or better than the currently installed devices which are Wintel - Tall Blue with Volume Ctrl & 24-inch Cord Duraclear handset. At its sole discretion, DOCCS may direct the reuse or replacement of currently installed telephones at some or all locations.

3.5.2 Portable Phones

The vendor shall provide portable (wired) phones that plug into standard jacks as required. At its sole discretion, DOCCS may direct the reuse or replacement of currently installed portable telephones at some or all locations.

3.5.3 Pedestal and Enclosures

The vendor must provide pedestals as specified by DOCCS for both inside and outside locations at DOCCS' direction. At its sole discretion, DOCCS may direct the reuse or replacement of currently installed pedestals and enclosures at some or all locations.

3.5.4 Tablets

The vendor's solution must provide tablets (tablet) for a portion of the Department's specialty populations such as Special Housing Units and Regional Mental Health Unit, etc. (approximately 5,000) to allow inmates to complete telephone calls via the tablet from their cell. Telephone calls completed via tablets must conform to all requirements and mandatory features of this RFP. Further, the tablets must provide a variety of off-line entertainment, as well as educational and religious content that is age-appropriate for a complete range of academic capabilities (see Attachment E). The successful bidder will work with DOCCS to finalize this content for the tablets.

3.5.4.1 Device Specifications

The vendor-provided tablets must conform, at a minimum, to the following:

- High-quality construction with a shatter-resistant and tamper-proof housing
- A 7" to 10" touch screen
- Sound limited to included earbuds only
- An internal, rechargeable, non-removable battery
- No camera
- User anonymity: no sign-on required to access preloaded content
- Content in Spanish (or language translation capabilities)
- No ability for inmates to download any content; devices must have preloaded content; DOCCS administrators must have the ability to add/remove content
- No ability to connect to any wireless network, except the ITS
- **At the Bidders' Conference, provide a sample tablet for DOCCS review of the durability and suitability for use in a secure environment.**
 - If rejected, each vendor will have the opportunity to provide an alternative device prior to RFP evaluation.

The vendor's proposal must address the following:

- **Describe how the proposed solution will operate.**
- **Detail the secure network to be provided for phone services through the tablets.**
- **Provide details of the device to be provided.**
- **Demonstrate that you can meet the minimal standards for entertainment, educational, and religious content. See Attachment E.**
- **Describe how DOCCS will be able to add/remove content as necessary.**
- **Provide details of the solution that will prohibit online access.**

3.5.5 Wiring

The vendor is responsible for the installation and maintenance of all ITS wiring from the Intermediate Distribution Frame (IDF) to the telephone and/or wireless tablet instruments. Category 3 or better cabling is required. At its sole discretion, DOCCS may direct the reuse or replacement of current wiring at some or all locations. All wiring and cabling shall be performed in accordance with manufacturer standards and guidelines and industry practices. All installations shall be labeled and documented as mutually agreed upon between DOCCS and the vendor.

3.5.6 Compliance

All equipment, wiring and component installations shall conform to all applicable building codes, electric codes and accepted industry standards.

3.5.7 Restoration of Facilities

The contractor shall restore all damaged walls, ceiling and facilities to their original condition and in compliance with all applicable building codes and requirements resulting from contractor actions and activities. All work must be pre-approved by DOCCS.

3.5.8 Inventory

The vendor must maintain a current inventory of all equipment and components and provide the inventory to DOCCS as requested.

Provide a sample inventory report with the proposal.

3.5.9 Environmental

DOCCS will provide space, electricity and HVAC to support up to two (2) nineteen-inch racks for premise-based equipment. The vendor is responsible for any additional requirements beyond ambient temperature and standard power.

Describe any additional requirements in your proposal and include the plan to provide those requirements.

3.5.10 Servers and Processors

Provide full specifications and product literature/brochures for all equipment required including, but not limited to, call processors, servers, storage devices, workstations and related components.

3.5.11 New Equipment

The contractor shall replace all existing premise-based equipment between the main distribution frame and the network point of presence with new equipment. All call processors, routers, multiplexers, channel banks, gateways, switches or any required system component shall be new.

Provide full specifications and product literature/brochures for all proposed new components.

3.6 Software Enhancements and Upgrades

The vendor shall provide software enhancements and upgrades for either proprietary or third-party software required by the proposed Inmate Telephone System (ITS), including wireless tablets, when the enhancement and upgrades are generally available in a customer production environment. The vendor shall be responsible for maintaining the installed ITS at the latest general release of the system software for all systems including the system administration or system reporting terminals/PCs. The vendor must upgrade or replace all third-party software and/or hardware prior to any end-of-support date set by the third-party provider. All software changes shall be preapproved by DOCCS and must utilize approved change management procedures and configuration management processes as defined under *Configuration Management* in [Section 3.2.2](#).

Provide complete documentation for all software upgrades or enhancements.

3.7 Maintenance

The vendor shall be solely responsible for the maintenance and support for all system components including telephones, pedestals, enclosures, circuits, network components, software, call processors and all other elements of the system.

Describe the maintenance and support capabilities, methods and procedures as related to the subsections below.

3.7.1 Maintenance Responsibility

Malfunctions which cannot be immediately diagnosed and pinpointed to a certain item of equipment or particular service will require the participation of all service suppliers until responsibility for the problem has been unequivocally established. As a part of maintenance responsibilities, the contractor shall represent DOCCS with the regulated telephone company, network provider, or any other third-party service provider, in order to identify and correct problems with service.

In no instance shall the failure to resolve the issue of responsibility relieve the contractor from the obligation to restore system operability with the least impact on the availability of service.

3.7.2 Damage

The vendor shall be responsible for the repair or replacement of all equipment damaged regardless of the cause including, but not limited to, inmate damage, natural disaster, and DOCCS' actions or operations at no cost to DOCCS.

3.7.3 Maintenance Window

All scheduled maintenance must be performed outside of the normal ITS operating hours which are currently 7:00 a.m. to 11:00 p.m. ET.

3.7.4 Maintenance Center Location

Within 14 days of notification of selection, the vendor shall detail the location and number of maintenance staff, the staff experience, DOCCS' facilities to be supported by each location, and procedures to provide on-site maintenance service at all the DOCCS' locations with vendor provided equipment to meet DOCCS performance requirements. If the origination points for the maintenance staff are their homes, rather than a maintenance center, the staffs' origination addresses must be provided. It is a mandatory requirement of this RFP that the vendor agrees to have maintenance personnel within a three (3) hour drive from their origination addresses to each of DOCCS' locations throughout New York State. Failure to do so will result in a breach of contract. A map of the DOCCS' facility locations is provided in Attachment B.

3.7.5 Maintenance Staff Experience

Service personnel must be trained and experienced with installation and maintenance of the proposed system and equipment. DOCCS reserves the rights to request copies of training certificates for service personnel and to reject any maintenance personnel it determines to be unqualified to perform maintenance service on the proposed equipment.

3.7.6 Preventive Maintenance

The vendor shall conduct an on-site inspection and preventative maintenance service for all premise-based equipment provided on a quarterly basis at a minimum. The vendor shall certify the completion of the quarterly inspection and notify DOCCS of any equipment changes. Provide a sample of the proposed preventive maintenance report and certification form, including but not limited to, components to be tested, and pass/fail criteria for each component.

The proposed schedule shall be consistent with DOCCS' operating requirements and shall be based upon the specific needs of the equipment being maintained.

3.7.7 Remedial Maintenance

DOCCS will maintain a call screening service for all facilities. All service calls will be placed by DOCCS or its agent. Facilities will have the option to call in service issues at DOCCS sole discretion. Remedial maintenance shall be performed upon notification to the vendor that the equipment/service is inoperable or unsuitable for operation. The contractor shall be responsible for assuring that on premise service for each request is provided in accordance with the DOCCS' service requirements as defined in Section 5.

3.7.8 Maintenance Request Reports

The vendor shall furnish DOCCS with a monthly report, in a format to be determined by DOCCS, of all maintenance requests. The report shall include, at a minimum, the following data for each request for assistance:

- Date and time notified
- Date and time of arrival
- Description of malfunction reported
- Diagnosis of failure and work performed
- Date and time failure was corrected
- Name of person performing the service
- Name of person and agency reporting trouble

3.8 Transition/Migration

The vendor shall assume responsibility for all inmate telephone services effective on a specific date to be set by DOCCS prior to the official contract award and act as the DOCCS' agent to assure uninterrupted ITS operations as of that date. The vendor shall be responsible for establishing agreements with the existing provider as required to maintain all existing services and functions. Pursuant to the previous ITS contract, the existing vendor has committed to deliver to DOCCS a Phase-Out plan 80 calendar days before contract completion or termination and to maintain contract compliance during the period of time leading up to the contract expiration or termination. During turnover of the ITS systems to the successor contractor, the incumbent will deliver an inventory of all vendor-owned property at all DOCCS' locations and any outstanding requests/enhancements/issues to DOCCS. At DOCCS' direction, the existing vendor will turn over all vendor-provided equipment at all DOCCS' locations by close of business on the last day of the contract.

Describe the plan to migrate from the current DOCCS' ITS system to the proposed system.

3.8.1 Project Management

Submit a proposed Project Plan in Microsoft Project format. Such plan must effect full statewide implementation within the required 90-day transition period. The Plan must include at least the following elements:

- Implementation plan
- Migration plan
- Fallback plan
- Risk management and mitigation plan
- Acceptance test plan
- Training plan
- Communications plan for both the DOCCS' users and the non-DOCCS' users
- Performance and service level plan
- Project reporting process and mechanisms
- Change management process
- Configuration management plan

3.8.1.1 Project Manager

The vendor shall provide a fulltime project manager for the duration of the implementation until DOCCS has accepted all system components and services. The project manager shall be responsible for the development and implementation of the project plan, all transition and migration requirements and acceptance testing. Within 14 days of the notification of tentative contract award, the selected bidder must provide a résumé for its proposed Project Manager for DOCCS' approval. The State reserves the right to require additional information, including the use of direct interviews and demonstrations, to make a determination of the proposed Project Manager's qualifications. DOCCS reserves the right to accept or reject any proposed candidates for this position.

3.8.1.2 DOCCS' Resources

In the Proposal, provide a breakdown of DOCCS' staff resources required for implementation, migration, and operation of their proposed solution.

3.8.1.3 Site Survey

After notice of tentative award, the selected vendor shall be responsible for performing a site survey at all of DOCCS' facilities and identifying all installation and facility issues that could impact implementation.

3.8.2 Call Recording Migration

DOCCS currently stores one year of recordings within the existing ITS platform. The vendor must transfer existing recordings from the current vendor system to the proposed system without loss of information, chain of custody and playback ability.

Describe the plan for this migration.

3.8.3 Fallback Plan

As part of the proposal, **provide details and procedures for the fallback plan to restore all services to the prior system in the event of failure upon cutover.**

3.8.4 Acceptance Testing

The project plan must include a draft Acceptance Test developed by the vendor. DOCCS will evaluate this plan for comprehensiveness **and reserves the right to make modifications to the plan to meet DOCCS' needs.** Failure to successfully complete the Acceptance Test may result in termination of vendor services and cancellation of the contract. DOCCS shall be the sole determinant of the success of the Acceptance Test. Billing for services under the contract will be contingent on the satisfactory completion of the Acceptance Test. If the initial acceptance test is not successfully accomplished, DOCCS, at its sole discretion, may require a retest of one or more of the acceptance test criterion.

3.8.5 Equipment Disposal

The contractor shall be responsible for the removal and environmentally certified disposal of all existing unused ITS equipment no later than 120 days after the successful completion of the acceptance test.

The contractor will be responsible for removal of all equipment replaced during the term of the contract at no cost to DOCCS. All data and software must be completely removed and destroyed in compliance with DOCCS security policies and procedures and certification of the completed decimation process provided.

3.9 Data Exchange

The ITS contractor and DOCCS' computing systems routinely exchange data to provide timely updates to the ITS that allow proper validation of an attempted call prior to processing. The contractor must comply with the frequency and data exchange format as specified in Attachment D, *Data Exchange Elements*, and provide communication access for the data exchange 24 hours per day. Where appropriate, DOCCS will make a reasonable attempt to add or modify formats or schemas to accommodate the vendor for new services implemented resulting from a contract award. Data Exchange Specifications are subject to change during the resulting contract term.

3.9.1 National Information Exchange Model (NIEM) Standards

The contractor agrees to migrate the existing data exchange requirements to data standards consistent with the NIEM as they become operational for ITS data elements at no cost to DOCCS. The bidder may find additional information regarding NIEM standards at <http://www.niem.gov>.

3.9.2 Data Reconciliation

The vendor shall provide on a weekly basis all data to DOCCS in a format specified by DOCCS in Attachment D for the purposes of data reconciliation. DOCCS will reconcile the vendor's data and transmit exceptions in the same format as the daily modifications as specified in Attachment D. The vendor shall accept the modifications as the master record.

3.10 Information Ownership

DOCCS shall own all inmate data, call recordings, and customer account records (collect call, pre-paid, and credit), and DOCCS' information developed, stored or used in the ITS. The vendor shall act as custodian of that information in accordance with applicable statutes, policies, regulations and procedures and shall provide the information to DOCCS upon request in a form and manner specified by DOCCS. The vendor agrees not to sell, use, share or display any data or to use data for any other purpose unless agreed upon, in writing, by DOCCS.

3.11 Security

Due to the sensitive, public safety nature of the services under the resulting contract, the vendor must describe, in detail, the security measures that will be taken for personnel, data, communications, systems and facilities in a Security Plan.

The security plan must address the steps the vendor will take with regard to protecting all information and services that result from this RFP.

Describe the security plan, including specific processes and procedures that your company will take to ensure the confidentiality of all information and data.

3.11.1 ITS System Security

The vendor shall describe the ITS system security for all data stored locally or in a central database.

Describe the proposed security system. All information must be encrypted.

3.11.2 Jurisdiction

The vendor must guarantee DOCCS that it will not transport or make available physically, electronically, verbally or in any other form or manner, any data (either test or production) provided or produced under the contract that is awarded as a result of this RFP outside of the borders of the United States.

3.11.3 Compliance

The vendor will comply with all the DOCCS' security policies and procedures and requirements as well as State security policies including, but not limited to, the NYS Enterprise Information Security Office (EISO). Information for this Security Policy is available at www.its.ny.gov/eiso/policies/security.

3.11.4 Background Checks

The vendor's personnel must meet DOCCS' requirements for background checks and be subject to ongoing review to assure that staff continues to meet security screening standards.

3.11.5 Information Security Breach

The vendor shall notify DOCCS immediately if it experiences any security breach that may cause DOCCS' data and/or customer's data to be corrupted or inappropriately accessed or used. Such notice shall occur within four (4) hours of any incident.

Provide a copy of your data security breach notification and response procedures.

3.12 Phase-Out Plan

The vendor shall provide DOCCS with a full explanation on how it will handle a transition situation at the end of the contract period. Any DOCCS-owned equipment located outside DOCCS' sites, such as recording equipment and software, must be provided to the next contractor or DOCCS at no cost. DOCCS shall own all premises-based equipment installed and all data. At DOCCS direction, the contractor must provide any and all data including call recordings to the new vendor or DOCCS.

3.13 Training

The vendor shall specify the training requirements and expected roles and responsibilities for all of DOCCS' ITS staff required for the planning, implementation and on-going operation of the ITS. The vendor shall provide all training at no cost to DOCCS.

The vendor will deliver the needed training in a manner, at a location and according to a schedule approved by DOCCS. All training will include proficiency testing and additional training will be provided at no additional cost until all participants achieve proficiency. The vendor will provide refresher training or training for new staff as needed at no cost.

List and describe all training, including the title, length, general content, and the proposed schedule for the training.

3.14 Documentation

The vendor must provide full, complete and up-to-date documentation specific to DOCCS' implementation no later than seven (7) business days prior to the beginning of implementation. The documentation shall include at a minimum the following:

- Detailed flowchart(s) depicting the entire inmate call process from the moment an inmate picks up the receiver to the completion of the call. The flow chart(s) shall include the time intervals for each phase of call completion.
- Network diagrams and documentation of all circuits, routers, switches and other components and the service provider(s) responsible for diagnostics and repair of each component shown.
- Documentation of security and operational procedures
- User documentation for administrators
- User documentation for investigators
- User documentation for correctional facility staff
- Training information for inmates

- Information for called parties
- Technical system documentation
- Customer-accessed web site design and content for account management and trouble reporting

3.15 Reporting

The vendor shall describe all available reports, standard and ad-hoc, including the file formats available, that are part of its solution; provide DOCCS with online access to run such reports; describe any methodology in which DOCCS may create its own custom reports; and explain how the data may be formatted, retrieved and transmitted to a DOCCS' workstation. On a monthly basis, the vendor shall provide, at a minimum, detailed reports in a format specified by DOCCS for

- all service level and performance requirement items as specified in [Section 5](#); and
- the number of calls, minutes, actual duration, billed duration, and revenue broken down by local, intralata, interlata, interstate and international destinations and the totals for each month and facility.

On an annual basis, the vendor shall provide a summary report containing the information identified above and any other customer account related information that DOCCS determines necessary.

Provide sample reports in proposal illustrating your capabilities to include specific details as described above.

END OF SECTION 3: TECHNICAL REQUIREMENTS

4 Customer Service

4.1 Support Services for DOCCS

4.1.1 Principal Technical Support Representatives

The vendor shall assign primary and secondary representatives who will be knowledgeable of DOCCS' operational and support requirements and service levels and who will act as the DOCCS' principal liaisons for both Technical and Customer Support and be available 24 hours per day. When the primary liaison is unavailable, the secondary shall assume those duties. DOCCS prefers that the primary contact be resident in New York State. Within 14 days of notification of the tentative contract award, the selected bidder must provide résumés of the proposed representatives for DOCCS approval. The State reserves the right to require additional information, including direct interviews and demonstrations, to facilitate a determination of the proposed representatives' qualifications. DOCCS reserves the right to accept or reject any proposed candidates for this position.

4.1.2 Toll-Free Access

The vendor must provide DOCCS with toll-free access for technical support that is available 24 hours per day, 365 days per year. Customer support access to knowledgeable personnel must be available within ten (10) minutes of the contact initiation by DOCCS.

4.1.3 DOCCS' Authorized Representatives

DOCCS will establish an authorized list of individuals or titles who have the authority to open trouble tickets and request maintenance dispatch or support services. The vendor will only act on the request of an authorized individual on the list.

4.1.4 Gate Clearance

The vendor shall be responsible for establishing all gate clearances in conformance with DOCCS' policies and procedures for on-site visits.

4.1.5 Ticketing System

The vendor shall utilize an automated ticketing system to log, track, manage and assure appropriate response to all calls for support. DOCCS and/or its representatives shall be provided real-time access to this system including the ability to create new tickets and run reports on service tickets related to services provided to DOCCS. Reporting capabilities associated with this system must comply with Section 3.15 above. The vendor must be prepared to work with DOCCS to integrate the proposed ticketing system with the trouble ticket system utilized by DOCCS.

Describe how this system will provide the required functions and explain the system's capabilities. Include details as to what level of visibility and access DOCCS will have.

4.1.6 DOCCS' Access to Customer Information

The vendor shall provide DOCCS and/or its representatives with secure online, real-time access to all customer information regarding account status and history.

Describe how this function will be provided, and explain its capabilities. Include details as to what level of visibility, access, and reporting DOCCS' ITS staff will have.

4.1.7 Court Evidence and Expert Witness Testimony

The vendor shall provide verification that its methods and procedures meet accepted legal standards for chain of evidence in legal proceedings. At no cost to DOCCS, the vendor shall provide affidavits as required throughout the term of the contract, support any legal proceedings, and provide expert witness testimony as needed. In the last five (5) years DOCCS has experienced approximately ten (10) incidents requiring expert witness services.

4.2 Support Services for Customers

DOCCS requires that the vendor provide account holders with responsible, reliable customer service and support as outlined herein. The vendor shall utilize an automated ticketing system to log, track, manage, and assure appropriate response to all calls for support from Customers. Reporting capabilities associated with this system must comply with Section 3.15 above.

Describe how this system will provide the required functions and explain the system's capabilities. Include details as to what level of visibility and access DOCCS' ITS staff will have.

4.2.1 Toll-Free Access

The vendor shall provide toll-free telephone access to knowledgeable customer service staff for at least the normal inmate telephone operating hours, which are currently 7:00 a.m. to 11:00 p.m. ET, 365 days per year. All customer service representatives must have access to up-to-date customer account information including at a minimum billing, payment and blocked call status and history.

4.2.2 Executive Order Number 26

Bidders should review this executive order prior to submitting proposals. You may access the executive order on the Governor's Web site: [No.26 STATEWIDE LANGUAGE ACCESS POLICY](#)

In the event that translation/interpretation services are required for languages other than the Spanish language, the selected Contractor must agree to comply with any requests by DOCCS to provide documents or other assistance to allow for translation or interpretation to be conducted.

4.2.3 Customer Account Access

The vendor shall provide customers with secure web-based access to account information including billing, payment and blocked call status and history. Customers should be provided the capability to securely add funds to their pre-paid account online. The vendor must transfer all existing accounts at no cost to the account holders.

Describe how your solution provides this functionality and explain its capabilities.

4.2.4 Customer Outreach

DOCCS meets periodically with inmate advocacy groups to discuss a variety of issues. The vendor's representative(s) will be required to attend such meetings to discuss ITS related issues.

4.2.5 Call Blocking

The vendor must notify customers prior to initiating a block on collect calls. If a collect call account is in arrears and the vendor applies a block, the vendor must provide an opportunity for the customer to establish a pre-pay account.

Provide details on how this will occur, at a minimum provide details for the following:

- **The steps initiated to contact the customer and describe how many and what types of attempts will be made**
- **What procedures are followed**

- **The timeframes between each step in the process**
- **The specific reasons why a call is blocked**
- **Any automatic processes that trigger a block**
- **What are the procedures and timeframes for customers to remove a block**

4.2.6 Vendor Account Policies

Identify in the proposal all policies including, but not limited to, call limits, billing amount limits, collect or pre-payment caps, and call-blocking criteria they plan to apply to customer accounts. DOCCS reserves the right to accept or reject any or all proposed policies.

4.2.7 Vendor Policy Changes

The vendor must notify DOCCS and the customers (all account holders) before implementing policy changes including, but not limited to, call limits, billing amount limits, collect or pre-payment caps and call-blocking criteria. All policy changes must be pre-approved by DOCCS and the appropriate regulatory authority.

4.2.8 Aggregated Billing Account for DOCCS-Approved Organizations

During the term of the contract, DOCCS may identify individuals or organizations that are approved to receive, at no additional charge, a single monthly bill for multiple accounts with billing detail at the individual account, groups (i.e. location specific) and master account level.

Describe how such billing will be performed, and identify any limitations associated with such aggregate billing. Include a sample bill reflecting monthly billing for individual lines, groups of lines and the master account.

END OF SECTION 4: CUSTOMER SERVICE

5 Performance Standards

5.1 Service Objectives

The vendor must provide services that meet the performance levels delineated below.

Describe what steps will be taken to meet or exceed DOCCS' performance and service-level objectives for the Inmate Telephone System:

5.1.1 Facility Service Objectives

A. Equipment

1. Installation: Time from vendor receipt of order to working installed equipment.

Performance Standard: 20 calendar days

2. Maintenance: Monthly Meantime to Repair

Performance Standard: 8 hours

B. System Software

1. Updates/new releases: Time from availability to system-wide deployment

Performance Standard: 6 months

C. Network

2. Service: Monthly Availability (entire system)

Performance Standard: 99.99% (7x24x365)

5.1.2 Customer Service Objectives

A. DOCCS as customer

1. Service

a. Resolution Rates

Performance Standard: >70% of calls resolved on first call

b. Wait times

Performance Standard: Monthly mean wait time < 60 seconds

c. Access to technical support

Performance Standard: Within 10 minutes 100% of the time

2. System Availability per site: Monthly Availability within operational hours.

Performance Standard: 99.9%

3. Data Transfer and availability

a. Timing

Performance Standard: Occurs within scheduled window 98% of the time

b. Accuracy

Performance Standard: 98% of transfers complete and correct on first transfer; 100% on second transfer.

4. Inmate Calls

a. Drops and Disconnects

Performance Standard: Less than 2% per site per month

b. Voice Quality

Performance Standard: Meet quality standard 99% per month

c. Complaints

Performance Standard: Less than 5% of average annual population per month

B. Inmates, family & friends as customers

1. Service

a. Resolution rate

Performance Standard: >70% of calls resolved on first call

b. Wait times

Performance Standard: Monthly mean wait time <60 seconds

c. Abandoned calls

Performance Standard: Not to exceed 10% of calls per month

d. Complaints

Performance Standard: Not to exceed 5% of accounts per year

5.2 Resolution of Reported Problems

DOCCS has established priority levels 1-5 for problem reporting. Level 1 problems shall be the highest priority and level 5 the lowest. DOCCS has the sole authority to determine the priority level of each reported problem and to determine if the problem has been resolved and the issue closed. Resolution time is based on a 24-hour-per-day basis, 365-days-per-year service.

Describe what steps will be taken to meet or exceed DOCCS' problem resolution objectives.

A. Priority Level 1 includes, but is not limited to the following:

1. Loss of critical functionality
2. 50% or more phones in a facility out of service
3. Loss of administrative or investigative access or function
4. Loss of monitoring or recording function

Performance Standard: The time requirement for resolution of Level 1 Problems is **4 hours.**

B. Priority Level 2 includes, but is not limited to the following:

1. Loss of significant functionality
2. Data exchange failure
3. 20%--49% of phones in a facility out of service

Performance Standard: The time requirement for resolution of Level 2 Problems is **8 hours**.

C. Priority Level 3 includes, but is not limited to the following:

1. Loss of insignificant functionality
2. Software fixes not critical to operations
3. Individual phones representing 10%—20% of phones in a facility
4. Loss of trouble ticket system

Performance Standard: The time requirement for resolution of Level 3 Problems is **24 hours**.

D. Priority Level 4 includes, but is not limited to the following:

1. Individual phones representing less than 10% of phones in a facility

Performance Standard: The time requirement for resolution of Level 4 Problems is **48 hours**.

E. Priority Level 5 includes, but is not limited to the following:

1. Represent scheduled maintenance activities and scheduled installation or removal of equipment

Performance Standard: The time requirement for resolution of Level 5 is **five working days**.

5.2.1 Failure to comply

After three occurrences when 50% or more of the phones in a correctional facility are out of service for more than four (4) hours at an affected facility, DOCCS may impose a remedial measure that will include free calling at the facility for the number of hours corresponding with the out-of-service lapse of time. Contractor will provide supporting documentation to demonstrate free calling provided.

5.2.2 Escalation Requirements

Time	Escalation Point	DOCCS Contact Point
Missed performance standard	Supervisor	TBD
Missed performance standard + two (2) hours	Manager	TBD
Missed performance standard + four (4) hours	Director	TBD
Missed performance standard + six (6) hours	Vice President	TBD

The vendor must establish procedures that provide, at a minimum, escalation to agreed-upon points of contact for the timeframes indicated above.

5.3 Performance Reviews

The vendor shall provide monthly, quarterly, and annual performance reports that meet DOCCS' specifications. The reports will include the data elements noted in Section 5 above along with the raw numbers used to achieve the percentages. Additionally, every quarter, the vendor shall provide a face-to-face review of all performance indicators and trends and a summary of service issues. The vendor shall provide an annual review of the operational status, the financial status, the cost and rate analysis as well as an overall contract review. All reports and reviews will be presented to DOCCS' staff.

Provide examples of draft reports.

END OF SECTION 5: PERFORMANCE REQUIREMENTS

6 Vendor Qualifications

6.1 Company Experience

The bidder shall submit satisfactory evidence that, in the sole judgment of DOCCS, it has at least three (3) years current experience providing ITS production systems and services for commercial or government clients. The proposed system must be a commercially available system and have been in full production for at least one (1) year for at least three (3) customers that serve at least a total of 500 inmate telephones each.

The bidder shall **submit three (3) client references** to support their experience claims. Incomplete or incorrect client contact information will be evaluated to the bidder's detriment. Current employees of DOCCS may not be used as references. **Bidders should advise proposed references that DOCCS will be calling them and confirm the references willingness to participate. The information must be provided using Appendix F, *Vendor Reference Form*.**

New York State will not be a test site for unproven technology. For all technology proposed, your references must include at least two sites where this technology has been in service as an integrated part of the inmate phone system for at least six (6) months. An onsite or real-time demonstration of the technology must be provided prior to finalization of the scoring for this procurement.

The subcontractors that will be used to perform any aspect of the work must complete Appendix F by providing three (3) references in the relative field of services. In addition, subcontractors must have at least three (3) years current experience providing the services in the specific field of service.

Provide the names of any federal, state or local correctional facilities and/or systems where the subcontractors' services have been used in the past three (3) years.

6.2 Past Performance

6.2.1 Security Incidents

Provide details on all incidents of security breaches, lost or misused data in last three (3) years including, but not limited to, the nature and extent of the incident, remedial actions taken, and current status.

6.2.2 Performance Data

Provide detailed performance information for the three (3) referenced systems identified in Section 6.1. At a minimum the performance information shall include the items identified in Section 5.1, *Service Objectives*.

6.2.3 Legal Validity

Provide documentation of the validity of its chain of evidence methodology and its acceptance in legal proceedings. Include the number of legal cases in last three (3) years where the methodology was successful, and explain any instances where the validity of the chain of evidence was not accepted.

6.3 Staff Qualifications

Provide information regarding the qualifications and experience of the individuals that will be the primary points of contact for both customer and technical services as outlined in [Section 4.1.1](#). Provide résumés and completed *Staff Qualification Forms* (Appendix G) for at least three (3) reference projects/assignments. **Include the dates of the relevant experience in the résumés and qualification forms.**

6.3.1 Staffing Numbers and Qualifications

Provide the following:

- The number of staff by functional area, work shift, average years of experience and turnover rates for the last three (3) years
- The ratio of customer service staff to the number of active accounts
- The ratio of the number of technical support staff to the number of installed sites

6.3.2 Staff Disqualification

DOCCS shall have the right to require the contractor to remove any individual assigned to this project at any time during the term of this contract at DOCCS' sole discretion.

6.3.3 Staff Resignation or Discharge

The contractor shall immediately notify DOCCS of the resignation or discharge of the primary points of contact assigned to this project. Transfer of knowledge must occur prior to the departure of any staff members. The contractor shall propose a qualified replacement for DOCCS' review and approval.

6.4 Vendor Responsibility

6.4.1 Vendor Responsibility Requirements

DOCCS conducts a review of prospective contractors ("Bidders") to provide reasonable assurances that the Bidder is responsive and responsible. A Vendor Responsibility Questionnaire is used for non-construction contracts and is designed to provide information to assess a Bidder's responsibility to conduct business in New York based upon financial and organizational capacity, legal authority, business integrity, and past performance history. By submitting a bid, Bidder agrees to fully and accurately complete the Vendor Responsibility Questionnaire. The Bidder acknowledges that the State's execution of the Contract will be contingent upon the State's determination that the Bidder is responsible, and that the State will be relying upon the Bidder's responses to the questionnaire when making its responsibility determination. See Appendix E for details.

The bidder agrees that if it is found by the State that the bidder's responses to the questionnaire were intentionally false or intentionally incomplete, on such finding, DOCCS will terminate the Contract. In no case shall such termination of the Contract by the State be deemed a breach thereof, nor shall the State be liable for any damages for lost profits or otherwise, which may be sustained by the Contractor as a result of such termination.

The Contractor shall at all times during the Contract term remain responsible. The Contractor agrees, if requested by the Commissioner of DOCCS or his designee, to present evidence of its continuing legal authority to do business in New York State, integrity, experience, ability, prior performance, and organizational and financial capacity.

The DOCCS' Commissioner or his designee, in his or her sole discretion, reserves the right to suspend any or all activities under this Contract, at any time, when he or she discovers information that calls into question the responsibility of the Contractor. In the event of such suspension, the Contractor will be given written notice outlining the particulars of such suspension. Upon issuance of such notice, the Contractor must comply with the terms of the suspension order. Contract activity may resume at such time as the DOCCS' Commissioner or his designee issues a written notice authorizing a resumption of performance under the Contract.

6.4.2 Complaint History

The vendor shall **provide full disclosure of complaints lodged against it to the Better Business Bureau, the FCC, any state public service commissions or similar agency and any state Attorneys General within the last three (3) years.**

END OF SECTION 6: VENDOR QUALIFICATIONS

7 Rates, Fees and Costs

The vendor is responsible for ensuring that all telephone services and rates comply with all applicable regulations including but not limited to the NYS Public Service Commission (PSC) and the Federal Communications Commission (FCC) throughout the term of this agreement. All rates shall be fixed for the term of the contract (Section 2.1) unless rate reductions are mandated by changes to state and/or federal regulations.

7.1 No Commissions

Effective April 1, 2007, pursuant to New York Correction Law §623, the New York State Department of Corrections and Community Supervision does not receive commissions from inmate telephone traffic nor is it soliciting commissions from any contract award resulting from this RFP.

7.2 Rate Structure

Please use Appendix H, *Cost Proposal Form*, to submit all of the required information.

7.2.1 Domestic

The rate proposed and charged by the vendor shall be a single, per minute rate inclusive of all fees, taxes, connect charges or other costs for all calls within the United States, its territories and protectorates, and Canada. The rate shall be the same for pre-paid and collect calls. Call rates may not exceed \$0.050.

7.2.2 International

Although DOCCS does not allow international calls currently, the vendor shall propose a rate structure for international calls detailing rates by country. The rates for international calls shall be a single per minute rate by country inclusive of all fees, taxes, connect charges or other costs. DOCCS reserves the right to implement any alternative international calling services and does not guarantee minimum international calling volume. Any location not within the area defined as covered by the domestic rate as detailed above shall be treated as international. The rate for each country shall be the same rate for pre-paid and collect calls. Also, please propose a blended rate that would be applicable for all countries at a per-minute rate.

7.2.3 Rate Requirements

The Vendor shall provide rates based on three decimal places (e.g. \$0.000) in the appropriate table in Appendix H. Rates shall apply only from called party acceptance of a call until the call is terminated rounded to the nearest whole minute (calls lasting up to and including 29 seconds over a whole minute shall be rounded down, calls greater than or equal to 30 seconds over a whole minute shall be rounded up.) There shall be no charge for the time for prompts, rate information or other functions. There shall be no additional charges or fees added to the cost of a call. Provide the types of federal and state taxes and surcharges in the table as indicated in Appendix H. Do not enter the monetary charge for the taxes or surcharges.

7.2.4 Ancillary Service Charges

- No provider shall charge an Ancillary Service Charge other than those permitted charges identified by the Federal Communications Commission and approved by DOCCS.
- No provider shall charge a rate for a permitted Ancillary Service Charge in excess of those rates approved by the Federal Communications Commission and approved by DOCCS.

7.2.5 Calling Patterns

Bidders will be provided with media containing call detail records for a six (6) month period prior to release of the RFP at the mandatory bidders' conference. **It will be the sole responsibility**

of the bidder to analyze the call patterns and data contained on the media. DOCCS shall not be responsible for establishing or guaranteeing any minimum number of calls, minutes used, or revenue generated.

7.3 Billing

Billing and account management should be as easy to use and understandable as possible. Vendors shall describe how their approach will support that objective and include narrative responses with the Cost Proposal form (Appendix H). Please reference the subsections/paragraph for all responses.

Describe the billing methodology, procedures, and practices noting particularly how it will assure the accuracy of its billing and maximize calling opportunities for inmates and their families and friends.

Include in the description if the bidder proposes to direct bill the called parties for collect calls or if billing will be performed by a third party or Local Exchange Carrier (LEC). If the LEC or a third party is responsible for the billing of collect calls the vendor shall identify all such parties within NYS with which they have this agreement.

7.3.1 Collect and Prepaid

The vendor billing options shall be limited to collect and pre-paid by the called party. DOCCS must pre-approve all billing and payment options. DOCCS may consider additional billing and payment options during the contract term solely at DOCCS discretion.

The vendor shall

- **not restrict** the pre-paid account holder from receiving the full dollar amount of services up to the balance held by the vendor;
- fully describe the process for a customer to initiate a pre-paid account that shall include all vendor policies, customer requirements, any and all fees and charges associated with a collect or pre-paid account regardless of the purpose of the fees or charges, any and all credit card fees or charges associated with funding a pre-paid account, and the minimum and maximum deposits allowed;
- fully describe the processes and policies of said pre-paid account after said account is initiated, including but not limited to, account activation, deposits, how to review account activity, checking account balance, obtaining refunds, how to close an account, or how to report fraudulent charges;
- fully describe in the proposal any fees (including refill fees), charges, penalties or the like that will be incurred by the account holder throughout the entire use of the account;
- not collect any fees or charges for calls or account maintenance, including, but not limited to, account activation, deposits, account activity or inactivity, account balance refunds, account closing, or third party charges unless such fees or charges are included in its proposal and agreed to by DOCCS. All existing accounts with the current DOCCS ITS service provider will be transferred without charge to the account holders. DOCCS, at its sole discretion, reserves the right to reject any and all such fees and charges. Fees and charges deemed to be appropriate will be included in the overall cost evaluation of the vendor's proposal.

7.3.2 NYS DOCCS Liability

DOCCS shall have **no responsibility or liability** and shall be held harmless for all costs for any call billing, charges, payments, uncollectible charges, or fraud under this contract. DOCCS shall not be held liable for any potential revenue loss to the vendor due to any decision on the part of DOCCS to disconnect third party calls after detection or for any other limitation of services or access including but not limited to disciplinary actions and lockdowns.

7.4 Financial Stability

The vendor shall provide evidence of its financial stability and resources to continue operations to meet the requirements of this RFP.

At a minimum, the vendor should provide the most recently available certified audited financial annual report, the most recent Dun and Bradstreet report and such other materials necessary to demonstrate its financial soundness.

END OF SECTION 7: RATES, FEES, AND COSTS

8 Contractual Issues

8.1 Appendix A / Order of Precedence

Appendix A — Standard Clauses for New York State Contracts, dated January 2014, attached hereto, is hereby expressly made a part of this solicitation document as fully as if set forth at length herein. The agreement resulting from a successful award will include the following documents. Conflicts between these documents will be resolved in the following descending order of precedence:

- Appendix A
- The Contract resulting from this RFP
- DOCCS Request for Proposal Number 2016-02 (this Document) including any addenda
- Selected Contractor's Proposal/Bid

8.2 Ethics Compliance

All proposers/contractors and their employees must comply with the requirements of §§73 and 74 of the Public Officers Law, other state codes, rules, regulations, and executive orders establishing ethical standards for the conduct of business with New York State. In signing the Contract, the Contractor certifies full compliance with those provisions for any present or future dealings, transactions, sales, contracts, services, offers, relations, etc., involving New York State and/or its employees. Failure to comply with those provisions may result in disqualification from the proposal process, termination of contract, and/or other civil or criminal proceedings as required by law.

8.3 Procurement Lobbying Act

New York's Legislative Law and the State Finance Law have been amended to regulate lobbying on procurement contracts. Chapter 1 of the Laws of 2005, State Finance Law § 139-j and k, which can be accessed through the NYS Office of General Services links below, imposes certain restrictions on communications between the Department and the bidder during the procurement process. The bidder is restricted from making contacts, beginning with the date of the bid advertisement in the NYS Contract Reporter through final approval of the contract award by the Office of the State Comptroller, with anyone other than the designated contact person identified in the RFP, unless it is contact that is among certain statutory exceptions as per State Finance Law § 139-k (3) (a). The designated staff are identified in Section 1.6 RFP. Department staff are required to obtain certain information when contacted during the "restricted period" and to make a determination of responsibility of the bidder pursuant to these two statutes. Certain findings of non-responsibility can result in rejection of the proposal, and in the event of two findings within a four-year period, the bidder is debarred from future State contracts. It is DOCCS' policy to immediately report to its ethics officer and/or inspector general any impermissible contact by any offeror (bidder) and, in addition, to comply with all requirements of the procurement lobbying and procurement stewardship acts. More information about State Finance Law Sections 139-j and k can be found on the website of the Office of General Services by accessing the following:

<http://www.ogs.ny.gov/aboutogs/regulations/advisoryCouncil/sf139-j.htm>
and <http://www.ogs.ny.gov/aboutogs/regulations/advisoryCouncil/sf139-k.htm>

All bidders must submit a completed *Procurement Lobbying Certificate* related to State Finance Law 139-j and k (Attachment C).

8.4 Sales and Compensating Use Tax Certification Requirements

Complete **Form ST-220-CA Contractor Certification**. The Contractor must file Form ST-220-CA to certify that it has filed Form ST-220-TD with the Tax Department and that the information contained on Form ST-220-TD is correct and complete as of the date that the Contractor files Form ST-220-CA. Access and complete Form ST-220-CA by using the following link:

http://www.tax.ny.gov/pdf/current_forms/st/st220ca_fill_in.pdf Please note that Form ST-200-TD must be filed with the NYS Tax Department at the address on the front page of the form. You can access Form ST-220-TD using the following link:

http://www.tax.ny.gov/pdf/current_forms/st/st220td_fill_in.pdf For *Questions and Answers Concerning Tax Law Section 5-a*, go to NYS Department of Tax and Finance at <http://www.tax.ny.gov/pdf/publications/sales/pub223.pdf>.

8.5 Encouraging the Use of NYS Business

In an ongoing effort to use New York State (NYS) businesses, DOCCS encourages bidders to partner with NYS subcontractors and/or suppliers. For this solicitation, bidders should identify the NYS businesses that they plan to use if awarded the contract resulting from this solicitation by completing the form entitled *Encouraging Use of New York State Businesses in Contract Performance*. If known, please identify the businesses and attach the requested information. Return the completed form with your proposal. If you do not plan to partner with a NYS business, please indicate this on the form and return it with your proposal. This form is included in Attachment C.

8.6 Diversity Practices

DOCCS has determined, pursuant to New York State Executive Law Article 15-A, that the assessment of the diversity practices of respondents to this procurement is practical, feasible, and appropriate. Diversity practices are the efforts of contractors to include New York State-certified Minority and Women-owned Business Enterprises (“M/WBEs”) in their business practices. Diversity practices may include past, present, or future actions and policies, and include activities of contractors contracts with private entities and governmental units other than the State of New York. Assessing the diversity practices of contractors enables contractors to engage in meaningful, capacity-building collaborations with M/WBEs.

Accordingly, respondents to this procurement shall be required to include as part of the technical proposal response to this procurement, as described in this RFP herein, the *Diversity Practices Questionnaire* as provided by the Division of Minority and Women’s Business Development. Bidders must complete the questionnaire in Appendix M. The bidders’ responses will be evaluated using a predetermined rating scale.

8.7 M/WBE and EEO Requirements

See Appendix C for Contractor requirements and procedures. The selected bidder will be required to return a completed Utilization Plan (Form M/WBE 100-G) and a completed Staffing Plan (Form EEO 100) as part of the contract resulting from this RFP. Appendix C will be included in the Contract resulting from this RFP.

8.8 Use of Service-Disabled Veteran-Owned Business Enterprises in Contract Performance

Article 17-B of the Executive Law enacted in 2014 acknowledges that Service-Disabled Veteran-Owned Businesses (SDVOBs) strongly contribute to the economies of the State and the nation. As defenders of our nation and in recognition of their economic activity in doing business in New York State, bidders/proposers for this contract for commodities, services or technology are strongly encouraged and expected to consider SDVOBs in the fulfillment of the requirements of the contract. Such partnering may be as subcontractors, suppliers, protégés or other supporting roles. SDVOBs can be readily identified on the directory of certified businesses at:

<http://www.ogs.ny.gov/Core/SDVOBA.asp>

Bidders/proposers need to be aware that all authorized users of this contract will be strongly encouraged to the maximum extent practical and consistent with legal requirements of the State Finance Law and the Executive Law to use responsible and responsive SDVOBs in purchasing and utilizing commodities, services and technology that are of equal quality and functionality to those that may be obtained from non-SDVOBs. Furthermore, bidders/proposers are reminded that they

must continue to utilize small, minority and women-owned businesses consistent with current State law. Utilizing SDVOBs in State contracts will help create more private sector jobs, rebuild New York State's infrastructure, and maximize economic activity to the mutual benefit of the contractor and its SDVOB partners. SDVOBs will promote the contractor's optimal performance under the contract, thereby fully benefiting the public sector programs that are supported by associated public procurements.

Public procurements can drive and improve the State's economic engine through promotion of the use of SDVOBs by its contractors. The State, therefore, expects bidders/proposers to provide maximum assistance to SDVOBs in their contract performance. The potential participation by all kinds of SDVOBs will deliver great value to the State and its taxpayers.

8.9 Indemnification

The Contractor shall assume all risks of liability for its performance, or that of any of its officers, employees, subcontractors, independent contractors, agents or any other person or entity performing contractual duties on Contractor's behalf, of any contract resulting from this solicitation and shall be solely responsible and liable for all liabilities, losses, damages, costs or expenses, including attorney's fees, arising from any claim, action or proceeding relating to or in any way connected with the performance of this Agreement and covenants and agrees to defend, indemnify and hold harmless the State of New York, its agents, officers and employees, from any and all claims, suits, causes of action and losses of whatever kind and nature, arising out of or in connection with its performance of any contract resulting from this solicitation, including negligence, active or passive or improper conduct of the Contractor, its officers, agents, subcontractors or employees, or the failure by the Contractor, its officers, agents, subcontractors or employees to perform any obligations or commitments to the State or third parties arising out of or resulting from any contract resulting from this solicitation. Such indemnity shall not be limited to the insurance coverage herein prescribed.

8.10 Contractor Insurance Requirements

Prior to the commencement of the work to be performed by the Contractor hereunder, the Contractor shall file with The People of the State of New York, DOCCS, Certificates of Insurance (hereinafter referred to as "Certificates"), evidencing compliance with all requirements. Such Certificates shall be of a form and substance acceptable to DOCCS.

Certificate acceptance and/or approval by DOCCS does not and shall not be construed to relieve Contractor of any obligations, responsibilities or liabilities under the Contract.

Contractors shall be required to procure, at their sole cost and expense, and shall maintain in force at all times during the term of any Contract resulting from this Solicitation, policies of insurance as required by this Section. All insurance required by this Section shall be written by companies that have an A.M. Best Company rating of "A-," Class "VII" or better. In addition, companies writing insurance intended to comply with the requirements of this Section should be licensed or authorized by the New York State Department of Financial Services to issue insurance in the State of New York. DOCCS may, in its sole discretion, accept policies of insurance written by a non-authorized carrier or carriers when certificates and/or other policy documents are accompanied by a completed Excess Lines Association of New York (ELANY) affidavit or other documents demonstrating the company's strong financial rating. If, during the term of a policy, the carrier's A.M. Best rating falls below "A-," Class "VII," the insurance must be replaced, on or before the renewal date of the policy, with insurance that meets the requirements above.

Bidders and Contractors shall deliver to DOCCS evidence of the insurance required by this Solicitation and any Contract resulting from this Solicitation in a form satisfactory to DOCCS. Policies must be written in accordance with the requirements of the paragraphs below, as applicable. While acceptance of insurance documentation shall not be unreasonably withheld, conditioned or delayed, acceptance and/or approval by DOCCS does not, and shall not be construed to, relieve Bidders or

Contractors of any obligations, responsibilities or liabilities under this Solicitation or any Contract resulting from this Solicitation.

The Contractor shall not take any action, or omit to take any action that would suspend or invalidate any of the required coverages during the term of the Contract.

A. General Conditions Applicable to Insurance. All policies of insurance required by this Solicitation or any Contract resulting from this Solicitation shall comply with the following requirements:

1. **Coverage Types and Policy Limits.** The types of coverage and policy limits required from Bidders and Contractors are specified in Paragraph B Insurance Requirements below.
2. **Policy Forms.** Except as otherwise specifically provided herein, or agreed to in the Contract resulting from this Solicitation, all policies of insurance required by this Section shall be written on an occurrence basis.
3. **Certificates of Insurance/Notices.** Bidders and Contractors shall provide DOCCS with a Certificate or Certificates of Insurance, in a form satisfactory to DOCCS as detailed below, and pursuant to the timelines set forth in Section B below. Certificates shall reference the Solicitation or award number and shall name The New York State Department of Corrections and Community Supervision, Harriman Campus, 1220 Washington Avenue, Albany, New York 12226-2050, as the certificate holder.

Certificates of Insurance shall

- Be in the form acceptable to DOCCS and in accordance with the New York State Insurance Law (e.g., an ACORD certificate);
- Disclose any deductible, self-insured retention, aggregate limit or exclusion to the policy that materially changes the coverage required by this Solicitation or any Contract resulting from this Solicitation;
- Refer to this Solicitation and any Contract resulting from this Solicitation by award number;
- Be signed by an authorized representative of the referenced insurance carriers; and
- Contain the following language in the Description of Operations / Locations / Vehicles section: Additional insured protection afforded is on a primary and non-contributory basis. A waiver of subrogation is granted in favor of the additional insureds.

Only original documents (certificates of insurance and any endorsements and other attachments) or electronic versions of the same that can be directly traced back to the insurer, agent or broker via e-mail distribution or similar means will be accepted.

DOCCS generally requires Contractors to submit only certificates of insurance and additional insured endorsements, although DOCCS reserves the right to request other proof of insurance. Contractors should refrain from submitting entire insurance policies, unless specifically requested by DOCCS. If an entire insurance policy is submitted but not requested, DOCCS shall not be obligated to review and shall not be chargeable with knowledge of its contents. In addition, submission of an entire insurance policy not requested by DOCCS does not constitute proof of compliance with the insurance requirements and does not discharge Contractors from submitting the requested insurance documentation.

4. **Primary Coverage.** All liability insurance policies shall provide that the required coverage shall be primary and non-contributory to other insurance available to the People of the

State of New York, the New York State Department of Corrections and Community Supervision, any entity authorized by law or regulation to use the Contract and their officers, agents, and employees. Any other insurance maintained by the People of the State of New York, the New York State Department of Corrections and Community Supervision, any entity authorized by law or regulation to use the Contract and their officers, agents, and employees shall be excess of all applicable Contractor's insurance, including any umbrella and/or excess policies, and shall not contribute with the Bidder/Contractor's insurance.

5. **Breach for Lack of Proof of Coverage.** The failure to comply with the requirements of this Section at any time during the term of the Contract shall be considered a breach of the terms of the Contract and shall allow the People of the State of New York, the New York State Department of Corrections and Community Supervision, any entity authorized by law or regulation to use the Contract and their officers, agents, and employees to avail themselves of all remedies available under the Contract or at law or in equity.
6. **Self-Insured Retention/Deductibles.** Certificates of Insurance must indicate the applicable deductibles/self-insured retentions for each listed policy. Deductibles or self-insured retentions above \$100,000.00 are subject to approval from DOCCS. Such approval shall not be unreasonably withheld, conditioned or delayed. Bidders and Contractors shall be solely responsible for all claim expenses and loss payments within the deductibles or self-insured retentions. If the Bidder/Contractor is providing the required insurance through self-insurance, evidence of the financial capacity to support the self-insurance program along with a description of that program, including, but not limited to, information regarding the use of a third-party administrator shall be provided upon request. If the Contractor is unable to meet their obligation under any deductible, self-insured retention or self-insurance, neither the People of the State of New York nor DOCCS will be obligated to drop down to cover the amount of the self-insured retention or deductible or any remaining portion thereof.
7. **Subcontractors.** Prior to the commencement of any work by a Subcontractor, the Contractor shall require such Subcontractor to procure policies of insurance as required by this Section and maintain the same in force during the term of any work performed by that Subcontractor.
8. **Waiver of Subrogation.** For all liability policies and the workers' compensation insurance required below, the Bidder/Contractor shall cause to be included in its policies insuring against loss, damage or destruction by fire or other insured casualty a waiver of the insurer's right of subrogation against The People of the State of New York, the New York State Department of Corrections and Community Supervision, any entity authorized by law or regulation to use the Contract and their officers, agents, and employees, or, if such waiver is unobtainable (i) an express agreement that such policy shall not be invalidated if the Contractor waives or has waived before the casualty, the right of recovery against The People of the State of New York, the New York State Department of Corrections and Community Supervision, any entity authorized by law or regulation to use the Contract and their officers, agents, and employees or (ii) any other form of permission for the release of The People of the State of New York, the New York State Department of Corrections and Community Supervision, any entity authorized by law or regulation to use the Contract and their officers, agents, and employees. A Waiver of Subrogation Endorsement shall be provided upon request. A blanket Waiver of Subrogation Endorsement evidencing such coverage is also acceptable.
9. **Additional Insured.** The Contractor shall cause to be included in each of the liability policies required below, ISO form CG 20 10 11 85 (or a form or forms that provide equivalent coverage, such as the combination of CG 20 10 04 13 and CG 20 37 04 13) and form CA 20 48 10 13 (or a form or forms that provide equivalent coverage), naming

as additional insureds: The People of the State of New York, the New York State Department of Corrections and Community Supervision, any entity authorized by law or regulation to use the Contract and their officers, agents, and employees. An Additional Insured Endorsement evidencing such coverage shall be provided to DOCCS pursuant to the timelines set forth in Section B below. A blanket Additional Insured Endorsement evidencing such coverage is also acceptable. For Contractors who are self-insured, the Contractor shall be obligated to defend and indemnify the above-named additional insureds with respect to Commercial General Liability and Business Automobile Liability, in the same manner that the Contractor would have been required to pursuant to this Section had the Contractor obtained such insurance policies.

- 10. Excess/Umbrella Liability Policies.** Required insurance coverage limits may be provided through a combination of primary and excess/umbrella liability policies; however, a minimum of one million dollars (\$1,000,000.00) must be primary coverage for general liability and auto liability. All Contractor's applicable insurance policies, including umbrella and excess insurance, will be primary to any insurance, self-insurance, deductible or self-insured retention of the People of the State of New York, the New York State Department of Corrections and Community Supervision, or any entity authorized by law or regulation to use the Contract and their officers, agents, and employees. If coverage limits are provided through excess/umbrella liability policies, then a Schedule of underlying insurance listing policy information for all underlying insurance policies (insurer, policy number, policy term, coverage and limits of insurance), including proof that the excess/umbrella insurance follows form must be provided upon request.
- 11. Notice of Cancellation or Non-Renewal.** Policies shall be written so as to include the requirements for notice of cancellation or non-renewal in accordance with the New York State Insurance Law. Within five (5) business days of receipt of any notice of cancellation or non-renewal of insurance, the Contractor shall provide DOCCS with a copy of any such notice received from an insurer together with proof of replacement coverage that complies with the insurance requirements of this Solicitation and any Contract resulting from this Solicitation.
- 12. Policy Renewal/Expiration** Upon policy renewal/expiration, evidence of renewal or replacement of coverage that complies with the insurance requirements set forth in this Solicitation and any Contract resulting from this Solicitation shall be delivered to DOCCS. If, at any time during the term of any Contract resulting from this Solicitation, the coverage provisions and limits of the policies required herein do not meet the provisions and limits set forth in this Solicitation or any Contract resulting from this Solicitation, or proof thereof is not provided to DOCCS, the Contractor shall immediately cease work. The Contractor shall not resume work until authorized to do so by DOCCS.
- 13. Deadlines for Providing Insurance Documents after Renewal or Upon Request.** As set forth herein, certain insurance documents must be provided to the DOCCS Procurement Services contact identified in the Contract Award Notice after renewal or upon request. This requirement means that the Contractor shall provide the applicable insurance document to DOCCS as soon as possible but in no event later than the following time periods:
 - For certificates of insurance: 5 business days
 - For information on self-insurance or self-retention programs: 15 calendar days
 - For other requested documentation evidencing coverage: 15 calendar days
 - For additional insured and waiver of subrogation endorsements: 30 calendar days

Notwithstanding the foregoing, if the Contractor shall have promptly requested the insurance documents from its broker or insurer and shall have thereafter diligently taken

all steps necessary to obtain such documents from its insurer and submit them to DOCCS, DOCCS shall extend the time period for a reasonable period under the circumstances, but in no event shall the extension exceed 30 calendar days.

B. Insurance Requirements

Bidders and Contractors shall obtain and maintain in full force and effect, throughout the term of any Contract resulting from this Solicitation, at their own expense, the following insurance with limits not less than those described below and as required by the terms of any Contract resulting from this Solicitation, or as required by law, whichever is greater:

Insurance Type		Proof of Coverage is Due
Commercial General Liability	[Not less than \$2,000,000 each occurrence]	Updated in accordance with Contract
General Aggregate	\$2,000,000	
Products – Completed Operations Aggregate	\$2,000,000	
Personal and Advertising Injury	\$1,000,000	
Medical Expenses Limit	\$5,000	
Business Automobile Liability Insurance	[Not less than \$2,000,000 each occurrence]	
Workers' Compensation		
Disability Benefits		

1. **Commercial General Liability Insurance:** Such liability shall be written on the current edition of ISO occurrence form CG 00 01, or a substitute form providing equivalent coverage and shall cover liability arising from premises operations, independent contractors, products-completed operations, broad form property damage, personal & advertising injury, cross liability coverage, liability assumed in a contract (including the tort liability of another assumed in a contract) and explosion, collapse & underground coverage.

Policy shall include bodily injury, property damage and broad form contractual liability coverage.

- General Aggregate
- Products – Completed Operations Aggregate
- Personal and Advertising Injury
- Each Occurrence

Coverage shall include, but not be limited to, the following:

- Premises liability;
- Independent contractors;
- Blanket contractual liability, including tort liability of another assumed in a contract;
- Defense and/or indemnification obligations, including obligations assumed under the Contract;
- Cross liability for additional insureds;

- Products/completed operations for a term of no less than three [1-3] years, commencing upon acceptance of the work, as required by the Contract;
- Explosion, collapse and underground hazards; and
- Contractor means and methods].

- 2. Business Automobile Liability Insurance:** Such insurance shall cover liability arising out of any automobile used in connection with performance under the Contract, including owned, leased, hired and non-owned automobiles bearing or, under the circumstances under which they are being used, required by the Motor Vehicles Laws of the State of New York to bear, license plates.

In the event that the Contractor does not own, lease or hire any automobiles used in connection with performance under the Contract, the Contractor does not need to obtain Business Automobile Liability Insurance, but must attest to the fact that the Contractor does not own, lease or hire any automobiles used in connection with performance under the Contract on a form provided by DOCCS. If, however, during the term of the Contract, the Contractor acquires, leases or hires any automobiles that will be used in connection with performance under the Contract, the Contractor must obtain Business Automobile Liability Insurance that meets all of the requirements of this section and provide proof of such coverage to DOCCS in accordance with the insurance requirements of any Contract resulting from this Solicitation.

In the event that the Contractor does not own or lease any automobiles used in connection with performance under the Contract, but the Contractor does subcontract, hire and/or utilize non-owned automobiles in connection with performance under the Contract, the Contractor subcontractor or owner of the automobile(s) must: (i) obtain Business Automobile Liability Insurance as required by this Solicitation or any Contract resulting from this Solicitation, except that such insurance may be limited to liability arising out of hired and/or non-owned automobiles, as applicable; and (ii) attest to the fact that the Contractor does not own or lease any automobiles used in connection with performance under the Contract, on a form provided by DOCCS. If, however, during the term of the Contract, the Contractor acquires or leases any automobiles that will be used in connection with performance under the Contract, the Contractor must obtain Business Automobile Liability Insurance that meets all of the requirements of this Section and provide proof of such coverage to DOCCS in accordance with the insurance requirements of any Contract resulting from this Solicitation.

3. Workers' Compensation Insurance and Disability Benefits Requirements

Sections 57 and 220 of the New York State Workers' Compensation Law require the heads of all municipal and state entities to ensure that businesses applying for contracts have appropriate workers' compensation and disability benefits insurance coverage. These requirements apply to both original contracts and renewals. **Failure to provide proper proof of such coverage or a legal exemption will result in a rejection of a Bid or any contract renewal. A Bidder will not be awarded a Contract unless proof of workers' compensation and disability insurance is provided to DOCCS.** Proof of workers' compensation and disability benefits coverage, or proof of exemption must be submitted to DOCCS at the time of Bid submission, policy renewal, contract renewal, and upon request. Proof of compliance must be submitted on one of the following forms designated by the New York State Workers' Compensation Board. **An ACORD form is not acceptable proof of New York State workers' compensation or disability benefits insurance coverage.**

Proof of Compliance with Workers' Compensation Coverage Requirements:

- Form CE-200, *Certificate of Attestation for New York Entities With No Employees and Certain Out of State Entities, That New York State Workers' Compensation and/or Disability Benefits Insurance Coverage is Not Required*, which is available on the Workers' Compensation Board's website (www.wcb.ny.gov);
- Form C-105.2 (9/07), *Certificate of Workers' Compensation Insurance*, sent to DOCCS by the Contractor's insurance carrier upon request, or if coverage is provided by the New York State Insurance Fund, they will provide Form U-26.3 to DOCCS upon request from the Contractor; or
- Form SI-12, *Certificate of Workers' Compensation Self-Insurance*, available from the New York State Workers' Compensation Board's Self-Insurance Office, or
- Form GSI-105.2, *Certificate of Participation in Workers' Compensation Group Self-Insurance*, available from the Contractor's Group Self-Insurance Administrator.

Proof of Compliance with Disability Benefits Coverage Requirements:

- Form CE-200, *Certificate of Attestation for New York Entities With No Employees and Certain Out of State Entities, That New York State Workers' Compensation and/or Disability Benefits Insurance Coverage is Not Required*, which is available on the Workers' Compensation Board's website (www.wcb.ny.gov);
- Form DB-120.1, *Certificate of Disability Benefits Insurance*, sent to DOCCS by the Contractor's insurance carrier upon request; or
- Form DB-155, *Certificate of Disability Benefits Self-Insurance*, available from the New York State Workers' Compensation Board's Self-Insurance Office.

An instruction manual clarifying the New York State Workers' Compensation Law requirements is available for download at the New York State Workers' Compensation Board's website, <http://www.wcb.ny.gov>. Once on the site, click on the Employers/Businesses tab and then click on Employers' Handbook.

8.11 Consultant Disclosure Reporting Requirements

Pursuant to New York State Finance Law, Section 163(4)(g), state agencies must require all contractors, including subcontractors, that provide consulting services for State purposes pursuant to a contract to submit an annual employment report for each such contract, such report to include for each employment category within the contract: the number of employees employed to provide services under the contract, the number of hours they work, and the total compensation under the contract for those employees. Consulting services are defined as analysis, evaluation, research, training, data processing, computer programming, engineering, environmental, health, and mental health services, accounting, auditing, paralegal, legal, or similar services.

Upon notification of award for this RFP, the selected Contractor must complete Form A, *State Consultant Services*. The completed Form A should include information for all employees that will be providing services under the contract resulting from this IFB.

The Contractor must submit Form B, *State Consultant Services Contractor's Annual Employment Report* (Attachment C), to report annual employment information required by the statute. This form captures historical information, detailing actual employment data for the most recently concluded State fiscal year (April 1 – March 31). Submit Form B to DOCCS Budget & Finance Unit, the Consultant Reporting Section of the Bureau of Contracts at OSC, and the Department of Civil Services at the addresses provided below.

Submit the completed Form B annually by May 15 for each State fiscal year (or portion thereof) the contract is in effect, as follows:

Contracting Agency: DOCCS

NYS Department of Corrections and Community Supervision

Sandra Downey, Director Budget and Finance
1220 Washington Avenue
Albany, New York 12226-2050

OSC: Consultant Reporting Sections of the Bureau of Contracts

NYS Office of the State Comptroller
Bureau of Contracts
110 State Street, Floor 11
Albany, NY 122236
Attention: Consultant Reporting

DCS:

NYS Department of Civil Service
Alfred E. Smith Office Building
Albany, NY 12239

Forms A and B as well as the instructions are found in Attachment C.

8.12 Freedom of Information Law/Trade Secrets

During the evaluation process, the content of each bid will be held in confidence and details of any bid will not be revealed (except as may be required under the Freedom of Information Law or other State law). The Freedom of Information Law provides for an exemption from disclosure for trade secrets or information the disclosure of which would cause injury to the competitive position of commercial enterprises. This exception would be effective both during and after the evaluation process. Should you feel your firm's bid contains any such trade secrets or other confidential or proprietary information, **you must submit a request to except such information from disclosure.** Such request must be in writing, must state the reasons why the information should be accepted from disclosure and must be provided at the time of submission of the subject information. Requests for exemption of the entire contents of a bid from disclosure have generally not been found to be meritorious and are discouraged. Kindly limit any requests for exemption of information from disclosure to bona fide trade secrets or specific information, the disclosure of which would cause a substantial injury to the competitive position of your firm.

8.13 Executive Order Number 26

Bidders should review this executive order prior to submitting proposals. You may access the executive order on the Governor's Web site: [STATEWIDE LANGUAGE ACCESS POLICY](#) In the event that translation/interpretation services are required for languages other than the Spanish language, the selected Contractor must agree to comply with any requests by DOCCS to provide documents or other assistance to allow for translation or interpretation to be conducted. Any costs associated with the translation or interpretation services will be incurred by DOCCS.

8.14 Executive Order 38

Limits on State-Funded Administrative costs & Executive Compensation: Bidders should review Executive Order 38 and the rules and regulations prior to submitting proposals. More specifically, Bidders should review the restrictions on allowable administrative expenses, the limits on executive compensation, and the reporting requirements. It is the obligation of the selected Contractor, not the State, to determine if Executive Order 38 is applicable. In addition, the selected Contractor must include a provision in any agreement with a subcontractor or agent stating that if said subcontractor or agent is receiving State funds or State-authorized payments from the Contractor to provide program or administrative services under the Contract resulting from this RFP, the subcontractor must also comply with Executive Order 38.

All Contractors doing business with DOCCS should be familiar with Executive Order 38 and the applicable DOCCS Rules and Regulations for the executive order.

Bidders and Contractors may access the executive order using this link, executiveorder38.ny.gov, or from the DOCCS' Web site at www.doccs.ny.gov. The applicable DOCCS Rules and Regulations for the executive order are located in the 7 New York Codes, Rules, and Regulations (NYCRR) Part 513.

8.15 Performance/Payment Bond Requirement

Prior to the commencement of performance of the work to be undertaken pursuant to the Contract, DOCCS requires the Contractor to furnish without cost to DOCCS a performance/payment bond as security for the faithful performance of the Contract in the amount of Ten Million Dollars (\$10,000,000.00), which shall be in the exact form and language of the sample bond attached as Appendix L. The surety must be authorized to do business as a surety in the State of New York, and its name must appear on the current list of sureties acceptable to the Treasury Department of the United States in effect at the time of submission of the Performance and Payment Bond to DOCCS. In addition, the aggregate underwriting limitations on any one risk as set forth in the aforementioned list of approved Treasury Department sureties shall equal or exceed the penal sum of the Performance and Payment Bond.

8.16 Licensed or Patented Components

The vendor must identify any software that is not owned by the vendor or any patented or proprietary components and provide details on the vendor's authorization to use and resell such components including duration of agreement and source.

8.17 Perpetual License

The vendor shall provide to DOCCS a perpetual non-exclusive license for all software utilized in the delivery of services under this contract. The license shall continue after the termination of the contract, but DOCCS shall not be entitled to free upgrades or support after contract termination.

8.18 Escrow of Software

Upon award the vendor shall escrow all software and routines, documentation and operational information necessary for the full production operation of the ITS with an escrow agent approved by DOCCS. The escrow agreement shall specify that the software source and production code and all related material shall be provided to DOCCS at no cost in the event that the vendor is unable or unwilling to meet its obligations under this contract. In such event DOCCS shall be deemed to have full ownership rights to the software and materials. The vendor shall at all times assure that the escrowed software and materials are for the current DOCCS' production system.

8.19 Breach of Services

In the event of any material breach of service by the contractor, the Department shall give written notice specifying the material breach. If such written notice of material breach is given and the provider does not correct the breach to DOCCS satisfaction within thirty (30) days after receipt of the written notice, DOCCS shall have the right to unilaterally and immediately terminate the Agreement and seek a replacement provider in order to maintain telephone service to the inmates without penalty to DOCCS.

8.20 General Requirements

The Bidder agrees to

1. adhere to all State and Federal laws and regulations in connection with the contract; and,
2. at a minimum, notify DOCCS of any changes in the legal status or principal ownership of the company, forty five (45) days in advance of said change.

The Bidder agrees that

3. in any contract resulting from this RFP, it shall be completely responsible for its work, including any damages or breakdowns caused by its failure to take appropriate action; and,
4. any contract resulting from this RFP may not be assigned, transferred, conveyed or the work subcontracted without the prior written consent of the Commissioner of DOCCS.
5. For reasons of safety and public policy, in any contract resulting from this RFP, the use of illegal drugs and/or alcoholic beverages by the Contractor or its personnel shall not be permitted while performing any phase of the work herein specified.
6. For purposes of any contract resulting from this RFP, the State will not be liable for any expense incurred by the Contractor for any parking fees or as a consequence of any traffic infraction or parking violations attributable to employees of the Contractor.
7. The Commissioner's interpretation of specifications shall be final and binding upon the Contractor.
8. The Commissioner of DOCCS will make no allowance or concession to the bidder for any alleged misunderstanding because of quantity, quality, character, location or other conditions.
9. Should it appear that there is a real or apparent discrepancy between different sections of specifications concerning the nature, quality or extent of work to be furnished, it shall be assumed that the bidder has based its bid on the more expensive option. Final decision will rest with the Commissioner of DOCCS.
10. **Inspection** – For purposes of any contract resulting from this RFP, the quality of service is subject to inspection and may be made at any reasonable time by the State of New York. Should it be found that quality of services being performed is not satisfactory and that the requirements of the specifications are not being met, the Commissioner of DOCCS may terminate the contract and employ another contractor to fulfill the requirements of the contract. The existing Contractor shall be liable to the State of New York for costs incurred on account thereof.
11. **Stop Work Order** - The Commissioner of DOCCS reserves the right to stop the work covered by this RFP and any contract(s) resulting therefrom at any time that it is deemed the successful Bidder is unable or incapable of performing the work to the state's satisfaction. In the event of such stopping, DOCCS shall have the right to arrange for the completion of the work in such manner as it may deem advisable and if the cost thereof exceeds the amount of the bid, the successful Bidder shall be liable to the State of New York for any such costs on account thereof. In the event that DOCCS issues a stop work order for the work as provided herein, the Contractor shall have ten (10) working days to respond thereto before any such stop work order shall become effective.
12. It is the Contractor's responsibility to maintain the equipment and materials provided for the work consistent with applicable safety regulations, health codes, and all policies or directives established by DOCCS. Failure to account for all equipment, materials, and tools or to report missing equipment, materials, and tools immediately may result in the termination of the contract.
13. DOCCS reserves the right to reject and bar from the facility any employee hired by the Contractor.

8.21 Equipment and Licenses Upon Termination

Upon contract termination all installed equipment, wiring, servers, communications components and related elements shall become the property of DOCCS without further cost to DOCCS. This shall explicitly include a perpetual license for all installed software. DOCCS shall own all elements required to continue the operation of a fully functional production system. The contractor shall provide all ITS services including but not limited to call recording and customer service and billing required by this contract for ninety (90) days after the contract termination date.

8.21.1 Agency Termination

DOCCS reserves the right to cancel the complete contract or any part thereof, at any time, giving the Contractor thirty (30) days written notice for convenience or unavailability of funds. If in the judgment of DOCCS, the Contractor fails or refuses to perform the work in accordance with the contract, DOCCS may terminate the contract immediately by written notice for cause.

Upon written notice to the Contractor, and a reasonable opportunity to be heard with appropriate DOCCS' officials or staff, the contract may be terminated by the DOCCS' Commissioner or his designee at the Contractor's expense where the Contractor is determined by the DOCCS Commissioner or his designee to be non-responsible. In such event, the DOCCS Commissioner or his designee may complete the contractual requirements in any manner he may deem advisable and pursue available legal or equitable remedies for breach.

DOCCS may, upon a thirty (30) day notice, terminate the contract resulting from this RFP in the event of the awarded Bidder's failure to comply with any of the bid's requirements unless the awarded Bidder obtained a waiver of the requirement.

In addition, DOCCS may also terminate any contract resulting from this RFP upon ten (10) days written notice if the Contractor makes any arrangement or assignment for the benefit of creditors.

Furthermore, DOCCS shall have the right, in its sole discretion, at any time to terminate a contract resulting from this RFP, or any unit portion thereof, with or without cause, by giving thirty (30) days written notice of termination to the Contractor.

Any termination by DOCCS under this Section shall in no event constitute or be deemed a breach of any contract resulting from this RFP and no liability shall be incurred by or arise against DOCCS, its agents and employees therefore for lost profits or any other damages.

8.21.2 Procurement Lobbying Termination

DOCCS reserves the right to terminate this contract in the event it is found that the certification filed by the Offeror in accordance with New York State Finance Law §139-k was intentionally false or intentionally incomplete. Upon such finding, DOCCS may exercise its termination right by providing written notification to the Offeror in accordance with the written notification terms of this contract.

8.22 Contract Terms

1. All provisions and requirements of Appendix A, *Standard Clauses for New York State Contracts*, which is attached hereto and forms a part hereof, will be incorporated into any contract resulting from this RFP, and will be binding upon the parties to such contract.
2. All provisions and requirements that are attached hereto and form a part hereof, will be incorporated into any contract resulting from this RFP, and will be binding upon the parties to such contract.
3. It is stipulated and agreed by the parties that the law of the State of New York shall solely and in all respects govern with relation to any dispute, litigation, or interpretation arising out of or connected with any contract resulting from this RFP.
4. Any contract resulting from this RFP shall not be deemed executed, valid or binding unless and until approved in writing by the Attorney General and the Comptroller of the State of New York.

8.23 Nondisclosure Agreement

Upon contract award, the selected vendor will be required to sign the non-disclosure agreement in Appendix I.

8.24 Contract Provisions

The entire RFP plus clarification questions and answers as well as the selected vendor's proposal shall be included in the final contract.

8.25 Potential Annual Revenue Payments

It is understood between the parties that, in the event a change is made to the law in New York State with respect to the permissible use of telephone revenue, the parties will meet in a good faith effort to negotiate a possible amendment regarding phone rates that are charged, which would be consistent with the change in such law. It is further understood that if an amendment is negotiated and agreed to, it would also have to be approved by all necessary governmental entities, including, but not limited to, the Office of the State Comptroller, and that said agreement would also have to meet any governmental regulatory restrictions that may apply.

Moreover, in the event of such a change as stipulated above, the parties will have an understanding that the revenue set-aside from the use of the inmate telephone system will not exceed \$ 2 million.

8.26 Inmate Secure Messaging Option

DOCCS is exploring the possibility of offering inmates the ability to communicate with those individuals listed on the inmates' call lists, using secure messaging and utilizing the infrastructure as described in the successful bidder's proposal response to this RFP. If DOCCS decides to implement this feature in the future, with a 90-day notice to the contractor selected, the following information will be applicable:

- The vendor will provide the ability for inmates to access and utilize secure messaging, including the sending and receiving of secure messages to those individuals on the inmates' call lists.
- The vendor will identify and detail any costs associated with accessing, sending, or receiving secure messages, including any additional surcharges or handling fees assessed by the vendor that will be charged to the friends and family sending the secure messages. The cost to send or receive secure messages must be less than the cost to send an equivalent written letter.
- The ability to conduct investigative analysis of the secure messages, including, but not limited to, key word searches, analytics, and investigative software, which shall be described in detail by the vendor.
- The vendor's proposed costs will conform to all other applicable rules within the contents of the resulting contract and this RFP, including all investigative, analytic and reporting capabilities. Prior to implementation of secure messaging, the vendor will provide information to DOCCS regarding all aspects of this additional service as follows:
 - A detailed plan for inmates to access secure messaging, including those in restricted or specialized housing.
 - Ability to send and receive secure messaging via a tablet or third party device.
 - Ability to perform translation of foreign languages secure messages.
 - A mechanism to securely monitor and review secure messages before they are sent or received by the inmate.

Any amendment to the original contract agreement resulting from this solicitation will be subject to approval by the Office of the Attorney General and the Office of the State Comptroller.

END OF SECTION 8: CONTRACTUAL ISSUES

9 Administrative Procedures

9.1 Communication with DOCCS

All inquiries concerning this RFP must be addressed in writing to the DOCCS' designated contact as specified in [Section 1.6](#). DOCCS' employees should not be contacted regarding this RFP except as authorized by the DOCCS' designated contact person identified in Section 1.6. Any unauthorized contact shall constitute grounds for disqualification and rejection of the bidder's proposal.

9.2 Procurement Rights

The state of New York reserves the rights for the following:

1. Reject any and all bids received in response to this Solicitation.
2. Withdraw the RFP at any time, at the agency's sole discretion.
3. Disqualify a bidder from receiving the award if the bidder, or anyone in the bidder's employ, has previously failed to perform satisfactorily in connections with public bidding or contracts.
4. Correct bidders' mathematical errors and waive or modify other minor irregularities in bids received, after prior notification to the bidder.
5. Adjust any bidder's expected costs of the bid price based on a determination of the evaluation committee that the selection of the said bidder will cause the state to incur additional costs.
6. Utilize any and all ideas submitted in the bids received.
7. Negotiate with bidders responding to this solicitation within the solicitation requirements to serve the best interests of the state.
8. Begin contract negotiations with another bidding contractor to serve the best interests of the state should DOCCS be unsuccessful negotiating a contract with the selected contractor within 21 days of the selection notification.
9. Waive any nonmaterial requirement not met by all bidders.
10. Not make an award under this solicitation.
11. Make an award under this solicitation in whole or in part.
12. Make multiple contract awards pursuant to the solicitation.
13. Have any service completed via separate competitive bid or other means, as determined to be in the best interest of the state.
14. Seek clarifications of bids.
15. If two or more offers are found to be substantially equivalent, the Commissioner of DOCCS, at his sole discretion, will determine award.

9.3 Proposal Format, Packaging, and Submission Instructions

Package the Technical, Cost, and Diversity Practices proposal components separately. All components should be clearly labeled with *RFP 2016-02*, the component name, and the bidder's name.

- Submit two (2) originals of the completed Technical Proposal, and ten (10) copies for a total of twelve (12) Technical Proposals including Appendix K, *Proposal Response Forms*, and required documents. The narrative responses must correspond with the relative sections/paragraphs of the RFP. An original signature should be applied to each original and copy. Include one electronic copy in PDF format of the technical proposal on an electronic medium.
- Submit two (2) original signed Cost Proposal Forms and attachments in a separate sealed and labeled envelope with the narrative responses for Section 7 and the documentation to substantiate financial stability.
- Submit two (2) original signed *Diversity Practices Questionnaires* with attached sheets in a separate sealed and labeled envelope.

- Submit proposals so that they will be in the possession of the DOCCS' contact person by 3:00 PM EDT on the day indicated in [Section 1.7](#). It is the sole responsibility of bidders to insure the proposals are received by the bid closing date and time.
- It shall be the responsibility of each bidder to see that its material is appropriately contained in some physical form that best guards against the loss of property in transit or in handling by DOCCS once received.
- Submit the proposal so that updated pages can be easily incorporated into the original.
- Place the official name of the firm submitting the proposal so that it appears on the outside front cover of each binder and/or envelope with the name of the designated contact person(s) as provided in [Section 1.6](#) of the RFP. Every copy of the proposal should have each major section separated with index tabs to identify the major sections of the proposal so that the proposal corresponds with the sections in the table of contents.
- Complete the forms in Appendix K, *Proposal Response Forms*, ensuring each box is checked to indicate that the bidder has read and agreed to the requirements in each of the sections of the RFP and has included the required supporting documentation with its proposals. The completed set of Response Forms shall be included in Technical Proposal component of the bidder's proposal with the narrative text the bidder deems relevant.
- Include all required substantiating documentation and responses as specified in the RFP and the Response Forms for Sections 2 through 7 of the proposal. The substantiating documentation and responses shall cross reference the associated paragraph number of the RFP. It is not necessary to repeat each paragraph text as it appears in the RFP, it is only necessary to ensure that the Proposal Response form is properly completed and the responses and required documentation are cross referenced to the appropriate RFP paragraph number.
- Identify all supporting documentation required in the RFP. DOCCS will not accept links to external websites in place of documentation. If the required documentation does not lend itself to being bound in the format specified, uniquely identify the documentation and reference it accordingly.
- This Request for Proposals is comprised of the RFP title page and *Notice to Bidders* page, the table of contents, the pages numbered sequentially in the footer ending with page number 58 and all of the Appendices and Attachments. If the bidder determines that a page(s) is missing or otherwise defective, the bidder should contact DOCCS immediately so that a corrected copy can be issued to the bidder. Bidders must ensure that all pages have been included in the RFP downloaded from the NYS Contract Reporter or DOCCS' Web site.
- Only those Bidders who furnish all required information will be considered.

Submit all required bid documents including signed bid addenda if any by the Proposal Due Date and time (Section 1.7), to the following address:

Proposal Submission for RFP2016-02
NYS Department of Corrections & Community Supervision
Division of Support Operations / Contract Procurement Unit
Attention: Velma Berry
550 Broadway
Menands, NY 12204

DOCCS will not consider emailed or faxed bid submissions.

COST PROPOSALS WILL NOT BE OPENED UNTIL THE TECHNICAL EVALUATION HAS BEEN COMPLETED.**9.3.1 Proposal Content**

Entire proposal:

1. Completed and signed *Application Cover Sheet* and *Individual, Corporation, Partnership, or LLC Acknowledgment* (within Attachment C). Return as cover sheet and second page for the Technical Proposal.
2. *Procurement Lobbying Certification* (within Attachment C).
3. Appendix K, *Proposal Response Forms*, and the Technical Response Narrative: two (2) originals, plus ten (10) copies, plus one electronic copy in PDF format on an electronic medium.
4. Appendix H, *Cost Proposal Form*: two (2) original signed *Cost Proposal Forms* with attachments, narratives for Section 7, and documentation to substantiate financial stability submitted in a separate sealed and labeled envelope.
5. Appendix M, *Diversity Practices Questionnaire*: two (2) original completed, signed, and notarized questionnaires. Follow the instructions on the questionnaire, complete the questions, include the attached sheets as instructed, and submit the completed questionnaires (plus documents) in a separate sealed and labeled envelope.

9.3.2 Other legal documents (required but not subject to pass/fail disqualification):

See Attachment C, *Bidders' Checklist and Required Documents*, due with the technical proposal or as a contingency for the tentative award:

- Online (or hard copy) *Vendor Responsibility Questionnaire* (Appendix E)
- M/WBE and EEO Required forms (Appendix C)
- *Encouraging Use of NYS Businesses in Contract Performance* (within Attachment C)
- Vendor Reference Form (Appendix F)
- Staff Qualification Form (Appendix G)
- *Non-Disclosure Agreement* (Appendix I)
- *Performance/Payment Bond* (Appendix L)
- Form A, *State Consultant Services – Contractor's Planned Employment* (within Attachment C)
- Form ST-220-CA (Section 8.4)
- Verification Workers' Compensation and NYS Disability Coverage (Section 8.10)

9.3.3 Technical Proposal

The Technical Proposal shall be defined as the bidder's narrative responses to the entire RFP as outlined in Appendix K, the completed and signed Appendix K, and all requested attachments and documentation. The Technical Response shall contain the following:

- A. The completed Proposal Response Forms (Appendix K) signed by the bidder's representative having the authority to commit the company to the obligations set forth in the proposal.
- B. Narrative responses to all requirements and issues in the RFP cross referenced to the sections and paragraph numbers in the RFP.
- C. Requested documentation.
- D. All forms included or cited in the RFP completed as required (Attachment C).

Read and follow the instructions for Appendix K before completing the form and the technical proposal narrative. Prepare the technical proposal narrative identifying the section/subsection and paragraph with which your responses correspond.

9.3.4 Cost Proposal

The Cost Proposal shall be defined as the completed Cost Proposal Form (Appendix H) showing the costs for all Contract Services requested herein; responses cross referenced to the subsections and paragraphs in Section 7 of the RFP; and documentation to substantiate the bidder's financial stability (Section 7.4). The costs shall be considered all inclusive. The Cost Proposal Form is to be packaged in a **separate envelope** labeled as *RFP 2016-02 Cost Proposal Form*. Include the bidder's name on the envelope. In the event the bidder is disqualified during the technical evaluation phase, the Cost Proposals will not be considered. The Cost Proposal Form must be signed by the bidder's representative having the authority to commit the company to the obligations set forth in the proposal.

9.3.5 Diversity Practices Questionnaire

Bidders must complete Appendix M, *Diversity Practices Questionnaire*, as described in this RFP herein. The bidders' responses will be evaluated using a separate predetermined rating scale. The resulting scores assigned for diversity practice will be worth up to 2% of the technical score. The Diversity Practices response is to be packaged in a **separate envelope** labeled as *RFP 2016-02 Diversity Practices Questionnaire*.

9.4 Proposal Evaluation

Bidders' proposals will be evaluated in an objective, comprehensive manner. The evaluation criteria will be applied uniformly and equally, ensuring that each qualified bidder has an opportunity to be fairly considered.

The process used to evaluate the proposals will proceed through the following phases:

9.4.1 Mandatory Requirements (Pass/Fail)

The proposals will be reviewed to determine that the bidder has met **all** mandatory requirements. Failure to meet any mandatory requirement will disqualify the bidder from further consideration.

New York State will not be a test site for unproven technology. For all technology proposed, your references must include at least two sites where this technology has been in service as an integrated part of the inmate phone system for at least six (6) months. An onsite or real-time demonstration of the technology must be provided prior to finalization of the scoring for this procurement.

9.4.2 Technical Evaluation (95 points)

The Technical Evaluation team will evaluate and rate the bidders' proposals using a rating scale and a predetermined scoring tool and award points for responses to the sections/subsections as indicated in the Appendix K. Responses to Appendix M, *Diversity Practices Questionnaire*, will be evaluated separately using a predetermined scale. The final Diversity Practices score for each bidder will be included in the Technical Evaluation score. Each bidder's technical proposal, as defined in Section 9.3.3, will be evaluated in three categories:

- A. Delivery of Services
- B. Telecommunication Capabilities
- C. Business Operations Capabilities

9.4.3 Cost Evaluation (5 points)

The Cost Evaluation will include the narrative response for Section 7.3 submitted with Appendix H, *Proposal Cost Form*, and the total requested Account Fees in Appendix H. The cost score will be calculated using a predetermined rating scale to evaluate responses to 7.3 and by assigning the highest possible score to the proposal with the lowest total account fees. All bidders' total account fees will be prorated by comparing it to the lowest total proposed account fees. Bidders should include the requested Financial Statements in Section 7.4 with their Cost Proposal submissions.

9.4.4 Composite Scores

If proposals satisfy the Mandatory Requirements (pass/fail), the points awarded for the Cost Evaluation and Technical Evaluation categories will be combined to arrive at a composite score. The proposals will then be ranked from highest to lowest score.

In accordance with State Finance Law §163(10)(a), when price and other factors are found to be substantially equivalent, the determination of the commissioner or agency head to award a contract to one or more of such bidders shall be final. The basis for determining the award shall be documented in the procurement record.

9.4.5 Debriefings

Bidders will be accorded fair and equal treatment with respect to their opportunity for debriefing. Prior to the final contract award, DOCCS shall, upon request, provide a debriefing which would be limited to review of the requesting bidder's proposal. After the final contract award, DOCCS shall, upon request, provide a debriefing to any bidder that responded to the RFP, regarding the reason that the bid submitted by the unsuccessful bidder was not selected for a contract award. The post award debriefing should be requested by the bidder within thirty (30) days of contract approval as posted on the OSC website (web address below).

<http://www.openbooknewyork.com/>

END OF SECTION 9: ADMINISTRATIVE PROCEDURES

Appendix A Standard Clauses For New York State Contracts

**PLEASE RETAIN THIS DOCUMENT
FOR FUTURE REFERENCE.**

TABLE OF CONTENTS

	Page
1. Executory Clause	3
2. Non-Assignment Clause	3
3. Comptroller's Approval	3
4. Workers' Compensation Benefits	3
5. Non-Discrimination Requirements	3
6. Wage and Hours Provisions	3-4
7. Non-Collusive Bidding Certification	4
8. International Boycott Prohibition	4
9. Set-Off Rights	4
10. Records	4
11. Identifying Information and Privacy Notification	4-5
12. Equal Employment Opportunities For Minorities and Women	5
13. Conflicting Terms	5
14. Governing Law	5
15. Late Payment	5
16. No Arbitration	5
17. Service of Process	5
18. Prohibition on Purchase of Tropical Hardwoods	6
19. MacBride Fair Employment Principles	6
20. Omnibus Procurement Act of 1992	6
21. Reciprocity and Sanctions Provisions	6
22. Compliance with New York State Information Security Breach and Notification Act	7
23. Compliance with Consultant Disclosure Law	7
24. Procurement Lobbying	7
25. Certification of Registration to Collect Sales and Compensating Use Tax by Certain State Contractors, Affiliates and Subcontractors	7
26. Iran Divestment Act	7

STANDARD CLAUSES FOR NYS CONTRACTS

The parties to the attached contract, license, lease, amendment or other agreement of any kind (hereinafter, "the contract" or "this contract") agree to be bound by the following clauses which are hereby made a part of the contract (the word "Contractor" herein refers to any party other than the State, whether a contractor, licenser, licensee, lessor, lessee or any other party):

1. EXECUTORY CLAUSE. In accordance with Section 41 of the State Finance Law, the State shall have no liability under this contract to the Contractor or to anyone else beyond funds appropriated and available for this contract.

2. NON-ASSIGNMENT CLAUSE. In accordance with Section 138 of the State Finance Law, this contract may not be assigned by the Contractor or its right, title or interest therein assigned, transferred, conveyed, sublet or otherwise disposed of without the State's previous written consent, and attempts to do so are null and void. Notwithstanding the foregoing, such prior written consent of an assignment of a contract let pursuant to Article XI of the State Finance Law may be waived at the discretion of the contracting agency and with the concurrence of the State Comptroller where the original contract was subject to the State Comptroller's approval, where the assignment is due to a reorganization, merger or consolidation of the Contractor's business entity or enterprise. The State retains its right to approve an assignment and to require that any Contractor demonstrate its responsibility to do business with the State. The Contractor may, however, assign its right to receive payments without the State's prior written consent unless this contract concerns Certificates of Participation pursuant to Article 5-A of the State Finance Law.

3. COMPTROLLER'S APPROVAL. In accordance with Section 112 of the State Finance Law (or, if this contract is with the State University or City University of New York, Section 355 or Section 6218 of the Education Law), if this contract exceeds \$50,000 (or the minimum thresholds agreed to by the Office of the State Comptroller for certain S.U.N.Y. and C.U.N.Y. contracts), or if this is an amendment for any amount to a contract which, as so amended, exceeds said statutory amount, or if, by this contract, the State agrees to give something other than money when the value or reasonably estimated value of such consideration exceeds \$10,000, it shall not be valid, effective or binding upon the State until it has been approved by the State Comptroller and filed in his office. Comptroller's approval of contracts let by the Office of General Services is required when such contracts exceed \$85,000 (State Finance Law Section 163.6-a). However, such pre-approval shall not be required for any contract established as a centralized contract through the Office of General Services or for a purchase order or other transaction issued under such centralized contract.

4. WORKERS' COMPENSATION BENEFITS. In accordance with Section 142 of the State Finance Law, this contract shall be void and of no force and effect

unless the Contractor shall provide and maintain coverage during the life of this contract for the benefit of such employees as are required to be covered by the provisions of the Workers' Compensation Law.

5. NON-DISCRIMINATION REQUIREMENTS. To the extent required by Article 15 of the Executive Law (also known as the Human Rights Law) and all other State and Federal statutory and constitutional non-discrimination provisions, the Contractor will not discriminate against any employee or applicant for employment because of race, creed, color, sex (including gender identity or expression), national origin, sexual orientation, military status, age, disability, predisposing genetic characteristics, marital status or domestic violence victim status. Furthermore, in accordance with Section 220-e of the Labor Law, if this is a contract for the construction, alteration or repair of any public building or public work or for the manufacture, sale or distribution of materials, equipment or supplies, and to the extent that this contract shall be performed within the State of New York, Contractor agrees that neither it nor its subcontractors shall, by reason of race, creed, color, disability, sex, or national origin: (a) discriminate in hiring against any New York State citizen who is qualified and available to perform the work; or (b) discriminate against or intimidate any employee hired for the performance of work under this contract. If this is a building service contract as defined in Section 230 of the Labor Law, then, in accordance with Section 239 thereof, Contractor agrees that neither it nor its subcontractors shall by reason of race, creed, color, national origin, age, sex or disability: (a) discriminate in hiring against any New York State citizen who is qualified and available to perform the work; or (b) discriminate against or intimidate any employee hired for the performance of work under this contract. Contractor is subject to fines of \$50.00 per person per day for any violation of Section 220-e or Section 239 as well as possible termination of this contract and forfeiture of all moneys due hereunder for a second or subsequent violation.

6. WAGE AND HOURS PROVISIONS. If this is a public work contract covered by Article 8 of the Labor Law or a building service contract covered by Article 9 thereof, neither Contractor's employees nor the employees of its subcontractors may be required or permitted to work more than the number of hours or days stated in said statutes, except as otherwise provided in the Labor Law and as set forth in prevailing wage and supplement schedules issued by the State Labor Department. Furthermore, Contractor and its subcontractors must pay at least the prevailing wage rate and pay or provide the prevailing supplements, including the premium rates for overtime pay, as determined by the State Labor Department in accordance with the Labor Law. Additionally, effective April 28, 2008, if this is a public work contract covered by Article 8 of the Labor Law, the Contractor understands and agrees that the filing of payrolls in a manner consistent with Subdivision 3-a of Section 220 of the Labor Law shall be a condition precedent to payment by the State of any

State approved sums due and owing for work done upon the project.

7. NON-COLLUSIVE BIDDING CERTIFICATION. In accordance with Section 139-d of the State Finance Law, if this contract was awarded based upon the submission of bids, Contractor affirms, under penalty of perjury, that its bid was arrived at independently and without collusion aimed at restricting competition. Contractor further affirms that, at the time Contractor submitted its bid, an authorized and responsible person executed and delivered to the State a non-collusive bidding certification on Contractor's behalf.

8. INTERNATIONAL BOYCOTT PROHIBITION. In accordance with Section 220-f of the Labor Law and Section 139-h of the State Finance Law, if this contract exceeds \$5,000, the Contractor agrees, as a material condition of the contract, that neither the Contractor nor any substantially owned or affiliated person, firm, partnership or corporation has participated, is participating, or shall participate in an international boycott in violation of the federal Export Administration Act of 1979 (50 USC App. Sections 2401 et seq.) or regulations thereunder. If such Contractor, or any of the aforesaid affiliates of Contractor, is convicted or is otherwise found to have violated said laws or regulations upon the final determination of the United States Commerce Department or any other appropriate agency of the United States subsequent to the contract's execution, such contract, amendment or modification thereto shall be rendered forfeit and void. The Contractor shall so notify the State Comptroller within five (5) business days of such conviction, determination or disposition of appeal (2NYCRR 105.4).

9. SET-OFF RIGHTS. The State shall have all of its common law, equitable and statutory rights of set-off. These rights shall include, but not be limited to, the State's option to withhold for the purposes of set-off any moneys due to the Contractor under this contract up to any amounts due and owing to the State with regard to this contract, any other contract with any State department or agency, including any contract for a term commencing prior to the term of this contract, plus any amounts due and owing to the State for any other reason including, without limitation, tax delinquencies, fee delinquencies or monetary penalties relative thereto. The State shall exercise its set-off rights in accordance with normal State practices including, in cases of set-off pursuant to an audit, the finalization of such audit by the State agency, its representatives, or the State Comptroller.

10. RECORDS. The Contractor shall establish and maintain complete and accurate books, records, documents, accounts and other evidence directly pertinent to performance under this contract (hereinafter, collectively, "the Records"). The Records must be kept for the balance of the calendar year in which they were made and for six (6) additional years thereafter. The State Comptroller, the Attorney General and any other

person or entity authorized to conduct an examination, as well as the agency or agencies involved in this contract, shall have access to the Records during normal business hours at an office of the Contractor within the State of New York or, if no such office is available, at a mutually agreeable and reasonable venue within the State, for the term specified above for the purposes of inspection, auditing and copying. The State shall take reasonable steps to protect from public disclosure any of the Records which are exempt from disclosure under Section 87 of the Public Officers Law (the "Statute") provided that: (i) the Contractor shall timely inform an appropriate State official, in writing, that said records should not be disclosed; and (ii) said records shall be sufficiently identified; and (iii) designation of said records as exempt under the Statute is reasonable. Nothing contained herein shall diminish, or in any way adversely affect, the State's right to discovery in any pending or future litigation.

11. IDENTIFYING INFORMATION AND PRIVACY NOTIFICATION.

(a) Identification Number(s). Every invoice or New York State Claim for Payment submitted to a New York State agency by a payee, for payment for the sale of goods or services or for transactions (e.g., leases, easements, licenses, etc.) related to real or personal property must include the payee's identification number. The number is any or all of the following: (i) the payee's Federal employer identification number, (ii) the payee's Federal social security number, and/or (iii) the payee's Vendor Identification Number assigned by the Statewide Financial System. Failure to include such number or numbers may delay payment. Where the payee does not have such number or numbers, the payee, on its invoice or Claim for Payment, must give the reason or reasons why the payee does not have such number or numbers.

(b) Privacy Notification. (1) The authority to request the above personal information from a seller of goods or services or a lessor of real or personal property, and the authority to maintain such information, is found in Section 5 of the State Tax Law. Disclosure of this information by the seller or lessor to the State is mandatory. The principal purpose for which the information is collected is to enable the State to identify individuals, businesses and others who have been delinquent in filing tax returns or may have understated their tax liabilities and to generally identify persons affected by the taxes administered by the Commissioner of Taxation and Finance. The information will be used for tax administration purposes and for any other purpose authorized by law. (2) The personal information is requested by the purchasing unit of the agency contracting to purchase the goods or services or lease the real or personal property covered by this contract or lease. The information is maintained in the Statewide Financial System by the Vendor Management Unit within the Bureau of State Expenditures, Office of the State Comptroller, 110 State Street, Albany, New York 12236.

12. EQUAL EMPLOYMENT OPPORTUNITIES FOR MINORITIES AND WOMEN.

In accordance with Section 312 of the Executive Law and 5 NYCRR 143, if this contract is: (i) a written agreement or purchase order instrument, providing for a total expenditure in excess of \$25,000.00, whereby a contracting agency is committed to expend or does expend funds in return for labor, services, supplies, equipment, materials or any combination of the foregoing, to be performed for, or rendered or furnished to the contracting agency; or (ii) a written agreement in excess of \$100,000.00 whereby a contracting agency is committed to expend or does expend funds for the acquisition, construction, demolition, replacement, major repair or renovation of real property and improvements thereon; or (iii) a written agreement in excess of \$100,000.00 whereby the owner of a State assisted housing project is committed to expend or does expend funds for the acquisition, construction, demolition, replacement, major repair or renovation of real property and improvements thereon for such project, then the following shall apply and by signing this agreement the Contractor certifies and affirms that it is Contractor's equal employment opportunity policy that:

(a) The Contractor will not discriminate against employees or applicants for employment because of race, creed, color, national origin, sex, age, disability or marital status, shall make and document its conscientious and active efforts to employ and utilize minority group members and women in its work force on State contracts and will undertake or continue existing programs of affirmative action to ensure that minority group members and women are afforded equal employment opportunities without discrimination. Affirmative action shall mean recruitment, employment, job assignment, promotion, upgradings, demotion, transfer, layoff, or termination and rates of pay or other forms of compensation;

(b) at the request of the contracting agency, the Contractor shall request each employment agency, labor union, or authorized representative of workers with which it has a collective bargaining or other agreement or understanding, to furnish a written statement that such employment agency, labor union or representative will not discriminate on the basis of race, creed, color, national origin, sex, age, disability or marital status and that such union or representative will affirmatively cooperate in the implementation of the Contractor's obligations herein; and
(c) the Contractor shall state, in all solicitations or advertisements for employees, that, in the performance of the State contract, all qualified applicants will be afforded equal employment opportunities without discrimination because of race, creed, color, national origin, sex, age, disability or marital status.

Contractor will include the provisions of "a", "b", and "c" above, in every subcontract over \$25,000.00 for the construction, demolition, replacement, major repair, renovation, planning or design of real property and improvements thereon (the "Work") except where the Work is for the beneficial use of the Contractor. Section Standard Clauses

312 does not apply to: (i) work, goods or services unrelated to this contract; or (ii) employment outside New York State. The State shall consider compliance by a contractor or subcontractor with the requirements of any federal law concerning equal employment opportunity which effectuates the purpose of this section. The contracting agency shall determine whether the imposition of the requirements of the provisions hereof duplicate or conflict with any such federal law and if such duplication or conflict exists, the contracting agency shall waive the applicability of Section 312 to the extent of such duplication or conflict. Contractor will comply with all duly promulgated and lawful rules and regulations of the Department of Economic Development's Division of Minority and Women's Business Development pertaining hereto.

13. CONFLICTING TERMS. In the event of a conflict between the terms of the contract (including any and all attachments thereto and amendments thereof) and the terms of this Appendix A, the terms of this Appendix A shall control.

14. GOVERNING LAW. This contract shall be governed by the laws of the State of New York except where the Federal supremacy clause requires otherwise.

15. LATE PAYMENT. Timeliness of payment and any interest to be paid to Contractor for late payment shall be governed by Article 11-A of the State Finance Law to the extent required by law.

16. NO ARBITRATION. Disputes involving this contract, including the breach or alleged breach thereof, may not be submitted to binding arbitration (except where statutorily authorized), but must, instead, be heard in a court of competent jurisdiction of the State of New York.

17. SERVICE OF PROCESS. In addition to the methods of service allowed by the State Civil Practice Law & Rules ("CPLR"), Contractor hereby consents to service of process upon it by registered or certified mail, return receipt requested. Service hereunder shall be complete upon Contractor's actual receipt of process or upon the State's receipt of the return thereof by the United States Postal Service as refused or undeliverable. Contractor must promptly notify the State, in writing, of each and every change of address to which service of process can be made. Service by the State to the last known address shall be sufficient. Contractor will have thirty (30) calendar days after service hereunder is complete in which to respond.

18. PROHIBITION ON PURCHASE OF TROPICAL HARDWOODS. The Contractor certifies and warrants that all wood products to be used under this contract award will be in accordance with, but not limited to, the specifications and provisions of Section 165 of the State Finance Law, (Use of Tropical Hardwoods) which prohibits purchase and use of tropical hardwoods, unless specifically exempted, by the State or any governmental

agency or political subdivision or public benefit corporation. Qualification for an exemption under this law will be the responsibility of the contractor to establish to meet with the approval of the State.

In addition, when any portion of this contract involving the use of woods, whether supply or installation, is to be performed by any subcontractor, the prime Contractor will indicate and certify in the submitted bid proposal that the subcontractor has been informed and is in compliance with specifications and provisions regarding use of tropical hardwoods as detailed in §165 State Finance Law. Any such use must meet with the approval of the State; otherwise, the bid may not be considered responsive. Under bidder certifications, proof of qualification for exemption will be the responsibility of the Contractor to meet with the approval of the State.

19. MACBRIDE FAIR EMPLOYMENT PRINCIPLES. In accordance with the MacBride Fair Employment Principles (Chapter 807 of the Laws of 1992), the Contractor hereby stipulates that the Contractor either (a) has no business operations in Northern Ireland, or (b) shall take lawful steps in good faith to conduct any business operations in Northern Ireland in accordance with the MacBride Fair Employment Principles (as described in Section 165 of the New York State Finance Law), and shall permit independent monitoring of compliance with such principles.

20. OMNIBUS PROCUREMENT ACT OF 1992. It is the policy of New York State to maximize opportunities for the participation of New York State business enterprises, including minority and women-owned business enterprises as bidders, subcontractors and suppliers on its procurement contracts.

Information on the availability of New York State subcontractors and suppliers is available from:

NYS Department of Economic Development
Division for Small Business
Albany, New York 12245
Telephone: 518-292-5100
Fax: 518-292-5884
email: opa@esd.ny.gov

A directory of certified minority and women-owned business enterprises is available from:

NYS Department of Economic Development
Division of Minority and Women's Business
Development
633 Third Avenue
New York, NY 10017
212-803-2414
email: mwbecertification@esd.ny.gov
<https://ny.newnycontracts.com/FrontEnd/VendorSearchPublic.asp>

The Omnibus Procurement Act of 1992 requires that by signing this bid proposal or contract, as applicable, Standard Clauses

Contractors certify that whenever the total bid amount is greater than \$1 million:

(a) The Contractor has made reasonable efforts to encourage the participation of New York State Business Enterprises as suppliers and subcontractors, including certified minority and women-owned business enterprises, on this project, and has retained the documentation of these efforts to be provided upon request to the State;

(b) The Contractor has complied with the Federal Equal Opportunity Act of 1972 (P.L. 92-261), as amended;

(c) The Contractor agrees to make reasonable efforts to provide notification to New York State residents of employment opportunities on this project through listing any such positions with the Job Service Division of the New York State Department of Labor, or providing such notification in such manner as is consistent with existing collective bargaining contracts or agreements. The Contractor agrees to document these efforts and to provide said documentation to the State upon request; and

(d) The Contractor acknowledges notice that the State may seek to obtain offset credits from foreign countries as a result of this contract and agrees to cooperate with the State in these efforts.

21. RECIPROCITY AND SANCTIONS PROVISIONS. Bidders are hereby notified that if their principal place of business is located in a country, nation, province, state or political subdivision that penalizes New York State vendors, and if the goods or services they offer will be substantially produced or performed outside New York State, the Omnibus Procurement Act 1994 and 2000 amendments (Chapter 684 and Chapter 383, respectively) require that they be denied contracts which they would otherwise obtain. NOTE: As of May 15, 2002, the list of discriminatory jurisdictions subject to this provision includes the states of South Carolina, Alaska, West Virginia, Wyoming, Louisiana and Hawaii. Contact NYS Department of Economic Development for a current list of jurisdictions subject to this provision.

22. COMPLIANCE WITH NEW YORK STATE INFORMATION SECURITY BREACH AND NOTIFICATION ACT. Contractor shall comply with the provisions of the New York State Information Security Breach and Notification Act (General Business Law Section 899-aa; State Technology Law Section 208).

23. COMPLIANCE WITH CONSULTANT DISCLOSURE LAW. If this is a contract for consulting services, defined for purposes of this requirement to include analysis, evaluation, research, training, data processing, computer programming, engineering, environmental, health, and mental health services, accounting, auditing, paralegal, legal or similar services, then, in accordance with Section 163 (4-g) of the State Finance Law (as amended by Chapter 10 of the Laws of 2006), the Contractor shall

timely, accurately and properly comply with the requirement to submit an annual employment report for the contract to the agency that awarded the contract, the Department of Civil Service and the State Comptroller.

24. PROCUREMENT LOBBYING. To the extent this agreement is a "procurement contract" as defined by State Finance Law Sections 139-j and 139-k, by signing this agreement the contractor certifies and affirms that all disclosures made in accordance with State Finance Law Sections 139-j and 139-k are complete, true and accurate. In the event such certification is found to be intentionally false or intentionally incomplete, the State may terminate the agreement by providing written notification to the Contractor in accordance with the terms of the agreement.

25. CERTIFICATION OF REGISTRATION TO COLLECT SALES AND COMPENSATING USE TAX BY CERTAIN STATE CONTRACTORS, AFFILIATES AND SUBCONTRACTORS.

To the extent this agreement is a contract as defined by Tax Law Section 5-a, if the contractor fails to make the certification required by Tax Law Section 5-a or if during the term of the contract, the Department of Taxation and Finance or the covered agency, as defined by Tax Law 5-a, discovers that the certification, made under penalty of perjury, is false, then such failure to file or false certification shall be a material breach of this contract and this contract may be terminated, by providing written notification to the Contractor in accordance with the terms of the agreement, if the covered agency determines that such action is in the best interest of the State.

26. IRAN DIVESTMENT ACT. By entering into this Agreement, Contractor certifies in accordance with State Finance Law §165-a that it is not on the "Entities Determined to be Non-Responsive Bidders/Offerers pursuant to the New York State Iran Divestment Act of 2012" ("Prohibited Entities List") posted at: <http://www.ogs.ny.gov/about/regs/DOCCS/ListofEntities.pdf>

Contractor further certifies that it will not utilize on this Contract any subcontractor that is identified on the Prohibited Entities List. Contractor agrees that should it seek to renew or extend this Contract, it must provide the same certification at the time the Contract is renewed or extended. Contractor also agrees that any proposed Assignee of this Contract will be required to certify that it is not on the Prohibited Entities List before the contract assignment will be approved by the State.

During the term of the Contract, should the state agency receive information that a person (as defined in State Finance Law §165-a) is in violation of the above-referenced certifications, the state agency will review such information and offer the person an opportunity to respond. If the person fails to demonstrate that it has ceased its engagement in the investment activity which is in violation of the Act within 90 days after the Standard Clauses

determination of such violation, then the state agency shall take such action as may be appropriate and provided for by law, rule, or contract, including, but not limited to, imposing sanctions, seeking compliance, recovering damages, or declaring the Contractor in default.

The state agency reserves the right to reject any bid, request for assignment, renewal or extension for an entity that appears on the Prohibited Entities List prior to the award, assignment, renewal or extension of a contract, and to pursue a responsibility review with respect to any entity that is awarded a contract and appears on the Prohibited Entities list after contract award.

Appendix B General Specifications

WARRANTIES

a. Product Performance: Where Contractor, Product manufacturer or service provider generally offers additional or more advantageous warranties than set forth below, Contractor shall offer or pass through any such warranties to DOCCS and the State of New York (hereinafter “Authorized User(s)” or State.

In addition, Contractor hereby warrants and represents that the Products acquired by the Authorized User under the terms and conditions of this Contract conform to the manufacturer's specifications, performance standards and documentation, and the documentation fully describes the proper procedure for using the Products.

Contractor further warrants and represents that Products, components or deliverables specified and furnished by or through Contractor shall individually, and where specified and furnished as a system, be free from defects in material and workmanship and will conform with all requirements of the Contract for the warranty period, or for a minimum of one (1) year from the date of acceptance, whichever is longer (“Project warranty period”).

Unless recycled or recovered materials are available in accordance with the Remanufactured, Recycled, Recyclable or Recovered Materials clause, Product offered shall be standard new equipment, current model or most recent release of regular stock product with all parts regularly used with the type of equipment offered. Contractor further warrants and represents that no attachment or part has been substituted or applied contrary to the manufacturer's recommendations and standard practice.

b. Title and Ownership: Contractor warrants and represents that it has (i) full ownership, clear title free of all liens, or (ii) the right to transfer or deliver specified license rights to any Products acquired by Authorized User under this Contract. Contractor shall be solely liable for any costs of acquisition associated therewith. Contractor shall indemnify Authorized Users and hold Authorized Users harmless from any damages and liabilities (including reasonable attorneys' fees and costs)

awarded by a court of competent jurisdiction arising from any breach of Contractor's warranties as set forth herein.

c. Product Warranty for Deliverables: During the Project warranty period, defects in the materials or workmanship of components or deliverables specified and furnished by or through Contractor shall be repaired or replaced by Contractor at no cost or expense to the Authorized User. Contractor shall extend the Project warranty period for individual component(s), or for the system as a whole, as applicable, by the cumulative period(s) of time, after notification, during which an individual component or the system requires servicing or replacement (down time) or is in the possession of the Contractor, its agents, officers, Subcontractors, distributors, resellers or employees (“extended warranty”).

Where Contractor, the Independent Software Vendor (ISV), or other third-party manufacturer markets any project deliverable delivered by or through Contractor with a standard commercial warranty, such standard warranty shall be in addition to, and not relieve the Contractor from, Contractor's warranty obligations during the Project warranty and extended warranty period(s). Where such standard commercial warranty covers all or some of the Project warranty or extended warranty period(s), Contractor shall be responsible for the coordination during the Project warranty or extended warranty period(s) with ISV or other third party manufacturer(s) for warranty repair or replacement of ISV or other third-party manufacturer's Product.

Where Contractor, ISV or other third-party manufacturer markets any Project Deliverable with a standard commercial warranty which goes beyond the Project warranty or extended warranty period(s), Contractor shall notify the Authorized User and pass through the manufacturer's standard commercial warranty to Authorized User at no additional charge; provided, however, that Contractor shall not be responsible for coordinating services under the third-party extended warranty after expiration of

the Project warranty and extended warranty period(s).

The Commissioner agrees that Contractor is not responsible for any modification of the Products made by an Authorized User without Contractor's approval.

d. Replacement Parts Warranty: If during the regular or extended warranty periods, parts or components break or fail to perform as intended, the Contractor shall promptly repair or, upon demand, replace the defective unit or component part affected. All costs for labor and material and transportation incurred to repair or replace defective Product during the warranty period(s) shall be borne solely by the Contractor, and the State or Authorized User shall in no event be liable or responsible therefor.

Any Product or parts thereof replaced by the Contractor under the Contract warranty shall be replaced at no cost to the Authorized User and guaranteed for the greater of: a) the Warranty Period set forth under paragraph (a) above; or b) if a separate warranty for that Product or parts thereof is generally offered by the manufacturer, the standard commercial warranty period offered by the manufacturer for the individual part or component.

e. **Virus Warranty:** The Contractor represents and warrants that any Licensed Software acquired by the Authorized User does not contain any known viruses. Contractor is not responsible for viruses introduced at Licensee's site.

f. **Date/Time Warranty:** Contractor warrants that Product furnished pursuant to this Contract shall, when used in accordance with the Product documentation, be able to accurately process date/time data (including, but not limited to, calculating, comparing, and sequencing) transitions, including leap year calculations. Where a Contractor proposes or an acquisition requires that specific Products must perform as a package or system, this warranty shall apply to the Products as a system.

Where Contractor is providing ongoing services, including but not limited to: i) consulting, integration, code or data conversion, ii) maintenance or support services,

iii) data entry or processing, or iv) contract administration services (e.g., billing, invoicing, claim processing), Contractor warrants that services shall be provided in an accurate and timely manner without interruption, failure or error due to the inaccuracy of Contractor's business operations in processing date/time data (including, but not limited to, calculating, comparing, and sequencing) various date/time transitions, including leap year calculations. Contractor shall be responsible for damages resulting from any delays, errors or untimely performance resulting therefrom, including but not limited to the failure or untimely performance of such services.

This Date/Time Warranty shall survive beyond termination or expiration of this contract as long as the Product is used by the governmental entity, or its successor, for whom the Product was originally purchased." Nothing in this warranty statement shall be construed to limit any rights or remedies otherwise available under this Contract for breach of warranty.

g. Workmanship Warranty: Contractor warrants that the services acquired under this Contract will be provided in a professional and workmanlike manner in accordance with industry standards. The Authorized User must notify Contractor of any services warranty deficiencies within ninety calendar days from performance of the services that gave rise to the warranty claim.

h. Miscellaneous: The Authorized User shall promptly notify the Contactor and the

Commissioner in writing of any claim of breach of any warranty provided herein.

The rights and remedies of the State and the Authorized Users provided in this clause are in addition to and do not limit any rights afforded to the State and the Authorized Users by any other clause of the Contract.

INDEMNIFICATION Contractor shall be fully liable for the actions of its agents, employees, partners or Subcontractors and shall fully defend, indemnify and hold harmless the Authorized Users from suits, actions, damages and costs of every name and description relating to personal injury and damage to real or personal tangible property caused by any intentional act or negligence of Contractor, its

agents, employees, partners or Subcontractors, which shall arise from or result directly or indirectly from this Contract, without limitation; provided, however, that the Contractor shall not indemnify to the extent any claim, loss or damage arising hereunder solely due to the negligent act, failure to act, gross negligence or willful misconduct of the Authorized Users.

The State shall give Contractor: (i) prompt written notice of any action, claim or threat of suit, or other suit, (ii) the opportunity to take over, settle or defend such action, claim or suit at Contractor's sole expense, and (iii) assistance in the defense of any such action, claim or suit at the expense of Contractor. In the event that an action or proceeding at law or in equity is commenced against the Authorized User arising out of a claim for death, personal injury or damage to real or personal tangible property caused by any intentional or willful act, gross negligence, or negligence of Contractor, its agents, employees, partners or Subcontractors, which shall arise from or result directly or indirectly from the Products supplied under this Contract, and Contractor is of the opinion that the allegations in such action in whole or in part are not covered by the indemnification and defense provisions set forth in the Contract, Contractor shall immediately notify the Authorized User and the New York State Office of the Attorney General in writing and shall specify to what extent Contractor believes it is obligated to defend and indemnify under the terms and conditions of the Contract and to what extent it is not so obligated to defend and indemnify. Contractor shall in such event attempt to secure a continuance to permit the State and the Authorized User to appear and defend their interests in cooperation with Contractor, as is appropriate, including any jurisdictional defenses the State and Authorized User may have. In the event of a dispute regarding the defense, the Contractor and the Attorney General shall try to reach an amicable resolution, but the Attorney General shall have the final determination on such matters.

INDEMNIFICATION RELATING TO THIRD PARTY RIGHTS The Contractor will also

defend, indemnify and hold the Authorized Users harmless from and against any and all damages, expenses (including reasonable attorneys' fees), claims, judgments, liabilities and costs in any action for infringement of a patent, copyright, trademark, trade secret or other proprietary right provided: a) such claim arises solely out of the Products as supplied by the Contractor, and not out of any modification to the Products made by Authorized User or by someone other than Contractor at the direction of the Authorized User without Contractor's approval, or by reason of an off-the-shelf component; and b) Authorized User gives Contractor prompt written notice of any such action, claim suit or threat of suit alleging infringement.

At Authorized User's option, Contractor may be given the opportunity to take over, settle or defend such action, claim or suit at Contractor's sole expense, and to provide assistance in the defense of any such action, claim or suit at the expense of Contractor.

Such indemnity shall only be applicable in the event of claims, judgments, liabilities and/or costs that may be finally assessed against Authorized User in any action for infringement of a patent, or of any copyright, trademark, trade secret or other third party proprietary right except to the extent such claims, judgments, liabilities and/or costs arise solely from the Authorized Users negligent act, failure to act, gross negligence or willful misconduct.

If usage of a Product shall be enjoined for any reason or if Contractor believes that it may be enjoined, Contractor shall have the right, at its own expense and sole discretion to take action in the following order of precedence: (i) to procure for the Authorized User the right to continue Usage (ii) to modify the service or Product so that usage becomes non-infringing, and is of at least equal quality and performance; or (iii) to replace such Product or parts thereof, as applicable, with non-infringing Product of at least equal quality and performance. If the above remedies are not available, the parties shall terminate the Contract, in whole or in part as necessary and applicable, provided that the Authorized User

is given a refund for any amounts paid for the period during which usage was not feasible.

In the event that an action at law or in equity is commenced against the Authorized User arising out of a claim that the Authorized User's use of the Product under the Contract infringes any patent, copyright, trademark, trade secret or proprietary right, and Contractor is of the opinion that the allegations in such action in whole or in part are not covered by the indemnification and defense provisions set forth in the Contract, Contractor shall immediately notify the Authorized User and the Office of the Attorney General in writing and shall specify to what extent Contractor believes it is obligated to defend and indemnify under the terms and conditions of the Contract and to what extent it is not so obligated to defend and indemnify. Contractor shall in such event protect the interests of the Authorized User and seek to secure a continuance to permit the Authorized User to appear and defend their interests in cooperation with Contractor, as is appropriate, including any jurisdictional defenses the Authorized User may have. This constitutes the Authorized User's sole and exclusive remedy for patent infringement, or for infringement of any other third party proprietary right.

LIMITATION OF LIABILITY Except as otherwise set forth in the Indemnification clause and the Indemnification Relating to Third Party Rights clause, the limit of liability shall be as follows:

- a.** Contractor's liability for any claim, loss or liability arising out of, or connected with the Products provided, and whether based upon default, or other liability such as breach of contract, warranty, negligence, misrepresentation or otherwise, shall in no case exceed direct damages in: (i) an amount equal to two (2) times the charges specified in the Purchase Order for the Products and services, or parts thereof forming the basis of the Authorized User's claim (said amount not to exceed a total of twelve (12) months charges payable under the applicable Purchase Order) or (ii) five hundred thousand dollars (\$500,000), whichever is greater.
- b.** The Authorized User may retain such monies from any amount due Contractor as may be necessary to satisfy any claim for damages, costs and the like asserted against the Authorized User unless Contractor at the time of the presentation of claim shall demonstrate to the Authorized User's satisfaction that sufficient monies are set aside by the Contractor in the form of a bond or through insurance coverage to cover associated damages and other costs.
- c.** Notwithstanding the above, neither the Contractor nor the Authorized User shall be liable for any consequential, indirect or special damages of any kind which may result directly or indirectly from such performance, including, without limitation, damages resulting from loss of use or loss of profit by the Authorized User, the Contractor, or by others.

Appendix C M/WBE Forms and Information

NEW YORK STATE CERTIFIED MINORITY AND WOMEN-OWNED BUSINESS ENTERPRISES

New York State Law

Pursuant to New York State Executive Law Article 15-A, the Department of Corrections and Community Supervision (DOCCS) recognizes its obligation under the law to promote opportunities for maximum feasible participation of certified minority and women-owned business enterprises and the employment of minority group members and women in the performance of DOCCS contracts.

In 2006, the State of New York commissioned a disparity study to evaluate whether minority and women-owned business enterprises had a full and fair opportunity to participate in State contracting. The findings of the study were published on April 29, 2010, under the title “The State of Minority and Women-Owned Business Enterprises: Evidence from New York” (“Disparity Study”). The report found evidence of statistically significant disparities between the level of participation of minority and women-owned business enterprises in State procurement contracting versus the number of minority and women-owned business enterprises that were ready, willing, and able to participate in state procurements. As a result of these findings, the Disparity Study made recommendations concerning the implementation and operation of the statewide certified minority and women-owned business enterprise program. The recommendations from the Disparity Study culminated in the enactment and the implementation of New York State Executive Law Article 15-A, which requires, among other things, that DOCCS establishes goals for maximum feasible participation of New York State Certified minority and women-owned business enterprises (“M/WBE”) and the employment of minority group members and women in the performance of New York State contracts.

Business Participation Opportunities for M/WBE’s

For purposes of this solicitation, DOCCS hereby establishes an overall goal of 30% for M/WBE participation, 15% for Minority-Owned Business Enterprises (“MBE”) participation and 15% for Women-Owned Business Enterprises (“WBE”) participation (based on the current availability of qualified MBE’s and WBE’s). A contractor on the subject contract must document “Good Faith Efforts” to provide meaningful participation by M/WBE’s as subcontractors or suppliers in the performance of the contract and contractor agrees that DOCCS may withhold payment pending receipt of the required M/WBE documentation. The directory of New York State Certified M/WBE’s can be viewed at: <http://www.esd.ny.gov/mwbe.html> . For guidance on how DOCCS will determine a contractor’s “Good Faith Efforts”, refer to 5 NYCRR §142.8.

In accordance with 5 NYCRR §142.13, contractor acknowledges that if it is found to have willfully and intentionally failed to comply with the M/WBE participation goals set forth in the contract, such finding constitutes a breach of contract and DOCCS may withhold payment from the contractor as liquidated damages.

Such liquidated damages shall be calculated as an amount equaling the difference between: (1) all sums identified for payment to M/WBE’s had the contractor achieved the contractual M/WBE goals; and (2) all sums actually paid to M/WBE’s for work performed or materials supplied under the contract.

APPENDIX C

By submitting a bid or proposal, a bidder on the contract agrees to submit the following documents and information as evidence of compliance with the foregoing:

- A. Bidders are required to submit an M/WBE Utilization Plan (Form M/WBE 100) with their bid or proposal. The utilization plan shall list the M/WBE's the contractor intends to use to perform the State contract and a description of the contract scope of work that the contractor intends to structure to meet the goals on the State contract, and the estimated or, if known, actual dollar amounts to be paid to and performance dates of each component of a State contract that the contractor intends to be performed by a NYS certified minority or woman-owned business. Any modifications or changes to the agreed participation by NYS certified M/WBE's set forth in the utilization plan submitted with the bid or proposal, after the contract award and during the term of the contract, must be reported on a revised M/WBE utilization plan submitted to DOCCS.
- B. DOCCS contracting unit will review the submitted M/WBE utilization plan and advise the bidder of their acceptance or issue a notice of deficiency within 20 days of receipt.
- C. If a notice of deficiency is issued, bidder agrees that it shall respond to the notice of deficiency within seven (7) business days of receipt by submitting to the contracting unit, a written remedy in response to the notice of deficiency. If the written remedy that is submitted is not timely or is found by DOCCS to be inadequate, DOCCS shall notify the bidder and direct the bidder to submit, within five (5) business days, a request for a partial or total waiver of M/WBE participation goals on a M/WBE Request Form Waiver (Form M/WBE 102). Failure to file the waiver form in a timely manner may be grounds for disqualification of the bid or proposal.
- D. DOCCS may disqualify a bidder as being non-responsive under the following circumstances:
 - a. If a bidder fails to submit an M/WBE Utilization Plan,
 - b. If a bidder fails to submit a written remedy to a notice of deficiency,
 - c. If a bidder fails to submit a request for waiver, or
 - d. If DOCCS determines that the bidder has failed to document good faith efforts.

Contractors shall attempt to utilize, in good faith, any MBE or WBE identified within its M/WBE Utilization Plan, during the performance of the contract. Requests for a partial or total waiver of established goal requirements made subsequent to contract award may be made at any time during the term of the contract to DOCCS, but must be made no later than prior to the submission of a request for final payment on the contract.

Contractors are required to submit an M/WBE Quarterly Compliance and Sub-Contractor Payment Report on Form M/WBE 101 to the contracting unit by the 15th day following each end of quarter over the term of the contract documenting the progress made toward achievement of the M/WBE goals of the contract.

Equal Employment Opportunity Requirements

By submission of a bid or proposal in response to this solicitation, the bidder/contractor agrees with all of the terms and conditions of Appendix A including Clause 12 – Equal Employment Opportunities for Minorities and Women. The contractor is required to ensure that it and any subcontractors awarded a subcontract over \$25,000 for the construction, demolition,

APPENDIX C

replacement, major repair, renovation, planning or design of real property and improvements thereon (the "Work") except where the work is for the beneficial use of the contractor, shall undertake or continue programs to ensure that minority group members and women are afforded equal employment opportunities without discrimination because of race, creed, color, national origin, sex, age, disability, or marital status. For these purposes, equal opportunity shall apply in the areas of recruitment, employment, job assignment, promotion, upgrading, demotion, transfer, layoff, termination, and rates of pay or other forms of compensation. This requirement does not apply to: (1) work, goods, or services unrelated to the contract; or (2) employment outside of New York State.

Bidder further agrees, where applicable, to submit with the bid a Staffing Plan (Form EEO 100) identifying the anticipated work force to be utilized on the contract and if awarded a contract, will, upon request, submit to the DOCCS an EEO Workforce Quarterly Compliance Report (Form EEO 101) identifying the workforce actually being utilized on the contract.

Further, pursuant to Article 15 of the Executive Law (the "Human Rights Law"), all other State and Federal statutory and constitutional non-discrimination provisions, the contractor and sub-contractors will not discriminate against any employee or applicant for employment because of race, creed (religion), color, sex, national origin, sexual orientation, military status, age, disability, predisposing genetic characteristic, marital status, or domestic violence victim status, and shall also follow the requirements of the Human Rights Law with regard to non-discrimination on the basis of prior criminal conviction and prior arrest.

Please note: Failure to comply with the foregoing requirements may result in a finding of non-responsiveness, non-responsibility, and/or a breach of the contract, leading to the withholding of funds, suspension or termination of the contract or such other actions or enforcement proceedings as allowed by the contract.

**MINORITY AND WOMEN-OWNED BUSINESS ENTERPRISES
EQUAL EMPLOYMENT OPPORTUNITY POLICY STATEMENT**

M/WBE AND EEO POLICY STATEMENT

I, _____, the _____ (title) of _____ (Contractor) agree that _____ (Contractor) has adopted the following policies with respect to Contract Number _____.

M/WBE

Contractor will make good faith efforts to achieve the M/WBE contract participation goals set by DOCCS for that area in which the State-funded project is located, by taking the following steps:

- A. Actively and affirmatively solicit bids for contracts and subcontracts from qualified State certified MBEs or WBEs, including solicitations to M/WBE contractor associations.
- B. Request a list of State-certified M/WBEs from DOCCS and solicit bids from them directly.
- C. Ensure that plans, specifications, request for proposals, and other documents used to secure bids will be made available in sufficient time for review by prospective M/WBEs.
- D. Where feasible, divide the work into smaller portions to enhance participations by M/WBEs. Encourage the formation of joint venture and other partnerships among M/WBE contractors to enhance their participation.
- E. Document and maintain records of bid solicitation, including those to M/WBEs and the results thereof. Contractor will also maintain records of actions that its Subcontractors have taken toward meeting M/WBE contract participation goals.
- F. Ensure that progress payments to M/WBEs are made on a timely basis so that undue financial hardship is avoided, and that bonding and other credit requirements are waived or appropriate alternatives developed to encourage M/WBE participation.

EEO

- A. Contractor will not discriminate against any employee or applicant for employment because of race, creed, color, national origin, sex, age, disability or marital status, will undertake or continue existing programs of affirmative action to ensure that minority group members are afforded equal employment opportunities without discrimination, and shall make and document its conscientious and active efforts to employ and utilize minority group members and women in its work force on state contracts.
- B. This organization shall state in all solicitation or advertisements for employees that in the performance of the State contract all qualified applicants will be afforded equal employment opportunities without discrimination because of race, creed, color, national origin, sex disability or marital status.

At the request of the contracting agency, this organization shall request each employment agency, labor union, or authorized representative will not discriminate on the basis of race, creed, color, national origin, sex, age, disability or marital status and that such union or representative will affirmatively cooperate in the implementation of this organization's obligations herein.

- D. Contractor shall comply with the provisions of the Human Rights Law, all other State and Federal statutory and constitutional non-discrimination provisions. Contractor and Subcontractors shall not discriminate against any employee or applicant for employment because of race, creed (religion), color, sex, national origin, sexual orientation, military status, age, disability, predisposing genetic characteristic, marital status or domestic violence victim status, and shall also follow the requirements of the Human Rights Law with regard to non-discrimination on the basis of prior criminal conviction and prior arrest.
- E. This organization will include the provisions of sections (a) through (d) of this agreement in every subcontract in such a manner that the requirements of the subdivisions will be binding upon each Subcontractor as to work in connection with the State contract.

Agreed to this _____ day of _____, 2_____

By: _____

Print: _____ Title: _____

_____ is designated as the Minority Business
(Name of Designated Liaison)

Enterprise Liaison responsible for administering the Minority and Women-Owned Business Enterprises- Equal Employment Opportunity (M/WBE-EEO) program.

M/WBE Contract Goals

No less than 30% Minority and Women-Owned Business Enterprise Participation.

_____ % Minority-Owned Business Enterprise Participation

_____ % Women-Owned Business Enterprise Participation

EEO Contract Goals

_____ % Minority Labor Force Participation

_____ % Female Labor Force Participation

(Authorized Representative)

Title: _____

Date: _____

Appendix D Sample Contract

AGREEMENT

This AGREEMENT made this 1 day of Month 2016 between the NEW YORK STATE DEPARTMENT OF CORRECTIONS AND COMMUNITY SUPERVISION (hereinafter referred to as "DOCCS"), with its principal office located at The Harriman State Campus, 1220 Washington Avenue, Albany, New York 12226 and Legal Name of Contractor (hereinafter "CONTRACTOR"), with its principal office located at address of the Contractor's Corporate Headquarters and

WHEREAS, pursuant to New York Correction Law § 112(1), the Commissioner of DOCCS is given the authority to contract with private entities for the performance of such functions deemed necessary or desirable to promote the efficient operation of DOCCS, as well as the fulfillment of all lawful responsibilities of DOCCS; and

WHEREAS, the CONTRACTOR is ready, willing and able to provide such services and possesses or can make available all necessary qualified personnel, licenses, facilities and expertise to perform or have performed the services required pursuant to the terms of this AGREEMENT.

NOW THEREFORE, in consideration of the promises, responsibilities and covenants herein, the STATE and the CONTRACTOR agree as follows:

I. TERM

- A. When signed by the parties, this AGREEMENT shall commence on Month 1, 2016, and be in effect through Month 30, 2021 ("Term") unless terminated earlier pursuant to its terms.

II. AMENDMENTS

- A. This AGREEMENT may be amended only upon the mutual written agreement of the parties.

- B. To modify the AGREEMENT within an existing Term or Renewal Term, the parties shall draft an Amendment to the Agreement.

III. TERMINATION

- A. Event of default: The contract may be terminated in the event of breach of any of its provisions by the Contractor, or if the Contractor's Services are deemed unsatisfactory in DOCCS's sole discretion, due to Contractor's fault or negligence, or that of its officers, employees, subcontractors, agents, licensees, licensors, or affiliates. In such event, DOCCS will send a written cure notice in accordance with the Notice provisions of the contract, and Contractor shall have thirty (30) days to correct the deficiencies noted. If the deficiencies are not corrected, DOCCS may terminate this contract immediately upon written notice.
- B. Deficient Certifications: If the awarded contract has a value greater than \$15,000, DOCCS shall have the right to terminate in the event the State Finance Law sections 139-j and 139-k certifications executed by the Contractor are found to be false or incomplete. If the contract has a value of greater than \$100,000 and Contractor's sales for the immediately preceding four quarters were greater than \$300,000, or if the contract has a value of \$125,000 or greater, DOCCS shall have the right to terminate in the event the Contractor's Department of Taxation and Finance Contractor Certification form, ST 220-CA, statements are found to be false or incomplete.
- C. Lack of Funds: If for any reason the State of New York terminates or reduces its appropriations to DOCCS, the awarded contract may be terminated or reduced at DOCCS's discretion, provided that no such reduction or termination shall apply to allowable costs already incurred by the Contractor where funds are available to the DOCCS for payment of such costs. In any event, no liability shall be incurred by the State (including DOCCS) beyond monies available for the purposes of the awarded contract.
- D. DOCCS may terminate the awarded contract, upon written notice, in the event of any of the following: (i) Contractor makes an assignment for the benefit of creditors; (ii) a

petition in bankruptcy or any insolvency proceeding is filed by or against Contractor and is not dismissed within thirty (30) days from the date of filing; or (iii) all or substantially all of Contractor's property is levied upon or sold in any judicial proceeding.

- E. Convenience of DOCCS: The contract may be terminated at any time upon receipt of thirty (30) days prior written notice given by DOCCS for whatever reason.
- F. DOCCS reserves the right to terminate immediately for cause.
- G. This AGREEMENT may be terminated at any time upon mutual written consent of DOCCS and the CONTRACTOR.
- H. In the event of the termination of this AGREEMENT by either party, DOCCS shall be liable for the actual and necessary expenses for services provided by CONTRACTOR up to and including the effective date of termination.

IV. CONTRACTOR RESPONSIBILITY

- A. The CONTRACTOR shall, at all times during the AGREEMENT term remain responsible. The CONTRACTOR agrees, if requested by the Commissioner of DOCCS or his designee, to present evidence of its continuing legal authority to do business in New York State, integrity, experience, ability, prior performance, and organizational and financial capacity.
- B. The Commissioner of DOCCS or his designee, in his sole discretion, reserves the right to suspend any or all activities under this AGREEMENT, at any time, when he discovers information that calls into question the responsibility of the CONTRACTOR. In the event of such suspension, the CONTRACTOR will be given written notice outlining the particulars of such suspension. Upon issuance of such notice, the

CONTRACTOR must comply with the terms of the suspension order. Contract activity may resume at such time as the Commissioner of DOCCS or his designee issues a written notice authorizing a resumption of performance under the Contract.

- C. Upon written notice to the CONTRACTOR, and a reasonable opportunity to be heard with appropriate DOCCS officials or staff, the AGREEMENT may be terminated by the Commissioner of DOCCS or his designee at the CONTRACTOR'S expense where the CONTRACTOR is determined by the DOCCS Commissioner or his designee to be non-responsible. In such event, the Commissioner or his designee may complete the contractual requirements in any manner he may deem advisable and pursue available legal or equitable remedies for breach.

V. REQUEST FOR PROPOSALS

- A. After a recent Request for Proposals (RFP) for an Inmate Telephone System, DOCCS has determined that the CONTRACTOR is the successful bidder resulting in the best value for the state and the CONTRACTOR is willing and able to provide the services required.

VI. SCOPE OF SERVICES

- A. Pursuant to this AGREEMENT, CONTRACTOR shall provide an inmate telephone system in accordance with DOCCS' Request for Proposals (hereinafter "RFP") 2016-02, a true copy of which is annexed hereto and made a part hereof as Appendix B; and the CONTRACTOR'S proposal for said RFP, a true copy of which is annexed hereto and made part of as Appendix C.

- C. It is expressly understood and agreed by CONTRACTOR that any and all services and products specified in this AGREEMENT shall be provided only at the direction of DOCCS.

VII. COMPENSATION

A. All compensation that will be paid to the CONTRACTOR is set forth in Appendix D, which is attached hereto and made a part of hereof. Appendix D consists of the CONTRACTOR'S Cost Proposal submitted in response to RFP 2016-02.

B. The selected Contractor will bill DOCCS twice each year during the term of the resulting contract. The first bill/invoice will be for the period beginning July 1, 2016, through December 31, 2016, and the second bill/invoice will be for the period beginning January 1, 2017, through June 30, 2017. The billing for subsequent years will be for July through December and January through June.

C. The selected CONTRACTOR shall provide complete and accurate billing invoices to DOCCS in order to receive payment. Billing invoices submitted to DOCCS must contain all information and supporting documentation required by the Contract, DOCCS, and OSC. Payment for invoices submitted by the CONTRACTOR shall only be rendered electronically unless payment by paper check is expressly authorized by the DOCCS' Commissioner, in the Commissioner's sole discretion, due to extenuating circumstances. Such electronic payment shall be made in accordance with ordinary State procedures and practices. The CONTRACTOR shall comply with the State Comptroller's procedures to authorize electronic payments. Authorization forms are available at the State Comptroller's website at www.osc.state.ny.us/epay/index.htm, by e-mail at epundit@osc.state.ny.us or by telephone at (518) 474-4032. CONTRACTOR acknowledges that it will not receive payment on any invoices submitted under the resulting Contract if it does not comply with the State Comptroller's electronic payment procedures, except where the Commissioner has expressly authorized payment by paper check as set forth above.

VIII. CONFIDENTIALITY

A. CONTRACTOR acknowledges that any and all information, records, files, documents or reports contained in any media format (e.g. print, electronic) provided to CONTRACTOR by the DOCCS or otherwise encountered by CONTRACTOR in the

provision of services pursuant to this AGREEMENT shall be considered extremely confidential and shall be handled accordingly at all times. Neither CONTRACTOR nor any of its employees, servants, subcontractors, agents or volunteers shall at any time be permitted to utilize any such confidential information for any purpose outside the scope of this AGREEMENT without the express prior written authorization of DOCCS. CONTRACTOR shall educate, monitor and be responsible for its employees, servants, subcontractors, agents and volunteers providing services for CONTRACTOR pursuant to this AGREEMENT concerning these confidentiality requirements. Any breach of the confidentiality requirements set forth in this Section or in Appendix B by CONTRACTOR or by any of its employees, servants, subcontractors, agents or volunteers may result in the immediate termination of this AGREEMENT by the DOCCS and may subject the CONTRACTOR to further penalties. Annexed hereto as Appendix E is a copy of the Non-Disclosure Agreement.

IX. INDEPENDENT CONTRACTOR

A. It is expressly understood and agreed that CONTRACTOR'S status hereunder is that of an independent contractor and that no official, employee, servant, subcontractor, agent or volunteer of CONTRACTOR is an employee of the DOCCS or the State of New York. CONTRACTOR is solely responsible for the work, compensation, benefits and personal conduct of all such persons assigned to the provision of services pursuant to this AGREEMENT. Nothing contained in this Section or in any other provision of this AGREEMENT shall be construed to impose any liability or duty to the DOCCS or the State of New York to persons, firms, consultants or corporations employed or engaged or otherwise utilized by the CONTRACTOR, either directly or indirectly, in any capacity whatsoever, nor shall the DOCCS or the State of New York be liable for any acts, omissions, obligations and taxes of any nature, including unemployment insurance and worker's compensation, of CONTRACTOR or any of its officials, employees, servants, subcontractors, agents or volunteers.

X. ASSIGNMENT

A. The rights and obligations of CONTRACTOR under this AGREEMENT may not be assigned, conveyed, transferred, or subcontracted by CONTRACTOR without prior written authorization of the DOCCS as set forth in Appendix A.

XI. NOTICES

A. All notices made pursuant to this AGREEMENT shall be in writing and shall be delivered to the addresses set forth below or to such addresses as the parties may from time to time provide to each other. Said notices should be served via registered mail or personally.

Notification to DOCCS: NYS DOCCS
Contract Procurement Unit
The Harriman State Campus
1220 Washington Avenue
Albany, New York 12226

Notification to CONTRACTOR:
Contractor Name
President – Government Division
Street Address
City, State 40223

or any other address as may be hereinafter designated by written notice. No notice shall be effective until received by the addressee. Communications concerning the daily functions and operation of the scope of services are not to be considered as notices. Thus, such communications may be done via telephone, e-mail, fax, United States Postal Service or other means.

XII. MISCELLANEOUS PROVISIONS

a. Entire Agreement: This AGREEMENT, including the face page and all its appendices, constitutes the entire AGREEMENT between the parties and supersedes all other communications between the parties relating to the subject matter herein.

b. Appendix A: DOCCS Appendix A (Standard Clauses as required by the Attorney General for all State contracts) is attached hereto and made a part hereof.

c. Order of Precedence: In the event of any conflict between the terms of this AGREEMENT and the terms of its Appendices, the following order of precedence shall apply:

1. Appendix A;
2. AGREEMENT;
3. Appendix B;
4. Appendix C;
5. Appendix D;
6. Appendix E; and
7. Appendix F.

d. Controlling Statutes: This AGREEMENT shall be governed by and construed in accordance with the laws of the State of New York.

e. Unenforceability: If any part of this AGREEMENT is found to be unenforceable for any reason, that part shall be deemed deleted and all other terms, conditions, and provisions of this AGREEMENT shall remain in full force and effect.

f. Captions: The captions contained in this AGREEMENT are intended for convenience and reference purposes only and shall in no way be deemed to define, limit or describe the scope or intent of this AGREEMENT, or any provision thereof, or in any way affect this AGREEMENT.

g. Defense and Indemnification: The contractor shall provide for the complete defense of the State, the Department, its officials, employees, and agents and for their complete indemnification from judgments, settlements, or losses that result from actions, claims, or proceedings, both judicial and administrative, that arise out of the contractor's performance of this contract. The contractor's duty to indemnify shall not be lessened by its utilization of subcontractors and shall cover direct, indirect, special and consequential damages.

- h. Force Majeure: Neither party shall be liable for losses, defaults, or damages, under this AGREEMENT which result from delays in performing, or inability to perform, all or any of the obligations or responsibilities imposed upon it pursuant to the terms and conditions of this AGREEMENT, due to or because of acts of God, the public enemy, acts of government, earthquakes, floods, strikes, typhoons, civil strife, fire or any cause beyond the reasonable control of the party that was so delayed in performing or so unable to perform, provided that such party was not negligent and shall have used reasonable efforts to avoid and overcome such cause. Such party will resume full performance of such obligations and responsibilities promptly upon removal of any such cause.
- i. Non-sectarian: CONTRACTOR is a non-sectarian organization and does not have as one of its purposes the advancement of any religion.
- j. Strict Adherence: The failure of DOCCS to insist upon strict adherence to any provision, fiscal obligation, reporting or other requirement of this AGREEMENT shall not be considered to constitute a waiver or constructive modification to deprive DOCCS of the right to insist upon strict adherence to the terms of this AGREEMENT in the future.
- k. M/WBE: By signing said AGREEMENT, CONTRACTOR agrees to comply with all requirements of Minority and Women Business Enterprise Laws, Regulations and Rules (M/WBE) Annexed hereto as Appendix F is a copy of the M/WBE policy.

Appendix E Vendor Responsibility Information

Vendor Responsibility

1. General Responsibility

The CONTRACTOR shall at all times during the Contract term remain responsible. The CONTRACTOR agrees, if requested by the Commissioner of DOCCS or his designee, to present evidence of its continuing legal authority to do business in New York State, integrity, experience, ability, prior performance, and organizational and financial capacity.

2. Suspension of Work for Non-Responsibility

DOCCS' Commissioner or his designee, in his or her sole discretion, reserves the right to suspend any or all activities under this Contract, at any time, when he or she discovers information that calls into question the responsibility of the CONTRACTOR. In the event of such suspension, the CONTRACTOR will be given written notice outlining the particulars of such suspension. Upon issuance of such notice, the CONTRACTOR must comply with the terms of the suspension order. Contract activity may resume at such time as the DOCCS' Commissioner or his designee issues a written notice authorizing a resumption of performance under the Contract.

3. Termination for Non-Responsibility

Upon written notice to the CONTRACTOR, and a reasonable opportunity to be heard with appropriate DOCCS officials or staff, the Contract may be terminated by the DOCCS' Commissioner or his designee at the CONTRACTOR'S expense where the CONTRACTOR is determined by the DOCCS Commissioner or his designee to be non-responsible. In such event, the DOCCS' Commissioner or his designee may complete the contractual requirements in any manner he may deem advisable and pursue available legal or equitable remedies for breach.

4. Vendor Responsibility Questionnaire

DOCCS recommends that vendors file the required *Vendor Responsibility Questionnaire* online using the New York State VendRep System. To enroll in and use the NYS VendRep System, see the VendRep System Instructions available at <http://www.osc.state.ny.us/vendrep/index.htm> or go directly to the VendRep System online at <portal.osc.state.ny.us/Enrollment>.

Vendors must provide their New York State Vendor Identification Number when enrolling. To request assignment of a Vendor ID or for VendRep System assistance, contact the Office of the State Comptroller's (OSC) Help Desk at 866 370-4672 or 518 408-4672 or by email at ciohelpdesk@osc.state.ny.us.

Vendors opting to complete and submit a paper questionnaire can obtain the appropriate questionnaire from the VendRep Web site, www.osc.state.ny.us/vendrep/forms_vendor.htm, or the OSC Help Desk for a copy of the paper form.

5. The Contractor must remain a responsible vendor throughout the duration of the contract and, if at any time the Contractor is found to be not responsible or there is a question as to the vendor's responsibility, any activities pursuant to the contract may be suspended. Finally, the contract may be terminated following a finding of non-responsibility.

To assist the State in determining the responsibility of the bidder, the bidder should complete and certify (or recertify) the Questionnaire no more than six (6) months prior to the bid due date.

A Bidder's Questionnaire cannot be viewed by DOCCS until the Bidder has certified the Questionnaire. It is recommended that all Bidders become familiar with all of the requirements

Vendor Responsibility

of the Questionnaire in advance of the bid opening to provide sufficient time to complete the Questionnaire.

The Bidder agrees that if it is found by the State that the bidder's responses to the questionnaire were intentionally false or intentionally incomplete, on such finding, DOCCS may terminate the Contract. In no case shall such termination of the Contract by the State be deemed a breach thereof, nor shall the State be liable for any damages for lost profits or otherwise, which may be sustained by the Contractor as a result of such termination.

Appendix F Vendor Reference Form

Vendor Reference Form

Complete a separate set of forms for the prime contractor and for each proposed subcontractor. Bidders and subcontractors should inform references in advance that DOCCS will be contacting them regarding the reference.

Prime Contractor Name:

Subcontractor Name (if applicable):

Complete a separate form for each of three (3) references

Reference Information

Reference organization name:

Address:

City:

State, zip code:

Contact person:

Name:

Title/position:

Phone number:

Email:

Services/systems bidder provided:

Initial Installation date:

System currently installed (model/release; indicate if same as proposed to DOCCS)

Number of locations/facilities:

Number phones:

Number inmates served:

Number of users:

Number of called party accounts:

Vendor Reference Form

Percentage of billings by type:

Collect:

Pre-paid:

International:

Performance statistics for past **12 months**:

System availability:

Network availability:

Mean time to repair (MTTR) premise equipment:

Number of system problems reported:

Mean time to resolve by priority level

Priority 1:

Priority 2:

Priority 3:

Customer service performance for the last **12 months**:

Average hold time:

Per cent of hang ups/dropped calls:

Number of complaints:

Mean resolution time:

Inmate calls performance for the last **12 months**

Availability:

Percent of drops and disconnects:

Number of complaints:

Appendix G Staff Qualification Form

Complete a separate form for each proposed staff person and attach full résumé.

Vendor Name:

Name of Proposed Staff:

Position and Title:

Name of Firm:

Telephone Number:

Role in This Contract:

Years of Experience - Total:

Years of Experience - With Current Firm:

Education (Degree(s) and Specialization):

References

Complete a separate form for each of three (3) references

Relevant Project:

Relevancy to DOCCS Requirements:

Reference Organization Name:

Address:

City, State, Zip Code:

Contact Name:

Title/Position:

Phone Number:

Email:

Specific Role:

Dates of relevant experience:

Brief Description (Brief scope, size, cost etc.):

Appendix H Cost Proposal Form

Prime Contractor Name: _____

Subcontractor Name(s) if applicable: _____

Authorized Signature: _____

Instructions: Complete the Cost Proposal Form showing the costs for the Contract Services requested. The costs shall be considered to be inclusive of all travel, overhead, profit, and administrative expenses. The cost proposal form shall be submitted in a separate self-addressed stamped envelope in the event the Bidder is disqualified and the Cost Proposal is unopened and returned.

Vendor shall provide rates based on three decimal places (e.g. \$0.000). Rates shall apply only from the called party's acceptance of a call until the call is terminated rounded to the **nearest** whole minute (calls lasting up to and including 29 seconds over a whole minute shall be rounded down, calls greater than or equal to 30 seconds over a whole minute shall be rounded up.) There shall be no charge for the time for prompts, rate information or other functions. There shall be no additional charges or fees added to the cost of a call.

Domestic Rate: The rate proposed and charged by the vendor shall be a single, per-minute rate inclusive of all fees, taxes, connect charges or other costs for all calls within the United States, its territories and protectorates, and Canada. **Call rates may not exceed \$0.050.**

Domestic per Minute Rate	Total Cost per Minute (including taxes, fees, & surcharges)

International Rates:

The vendor shall propose a rate structure for international calls detailing rates by country. The rates for international calls shall be single, per-minute rates by country inclusive of all fees, taxes, connect charges or other costs. DOCCS reserves the right to implement any alternative international calling services and does not guarantee minimum international calling volume. Any location not within the area defined as covered by the domestic rate as detailed above shall be treated as international.

Country	Total Cost per Minute (including taxes, fees, & surcharges)

Account Holder Fees:

Itemize any fees below that may be incurred by account holders throughout the entire use and closure of the account:

Account Fees	Amount Charged Account Holders
<i>Example: Automated payment fees¹</i>	<i>\$3.00</i>
Total of all fees:	

Federal and State Surcharges and Taxes:

Identify all federal and state surcharges and taxes that will be applied to the proposed rates for direct-billed and prepaid calls (**do not include amount of tax or surcharge**):

Taxes and Surcharges

¹ Automated payments include payments by interactive voice response (IVR).

Appendix I Non-Disclosure Agreement

**NEW YORK STATE
DEPARTMENT OF CORRECTIONS AND COMMUNITY SUPERVISION**

NON-DISCLOSURE AGREEMENT

This Non-Disclosure Agreement is entered into on the ___ day of _____, 20__ by and between the New York State Department of Corrections and Community Supervision (hereinafter "DOCCS"), located at The Harriman State Campus, 1220 Washington Avenue, Albany, New York 12226 and _____ (hereinafter "Recipient") located at _____.

The DOCCS is a law enforcement agency that is responsible for the confinement of inmates and supervises parolees in New York State. DOCCS possesses information relating to inmates and/or parolees that is confidential and is maintained for public safety and welfare.

NOW THEREFORE, in consideration for the mutual undertakings of the DOCCS and the Recipient under this Agreement, the parties agree as follows:

1. Confidential Information

The Recipient acknowledges that during the course of the engagement at DOCCS, there may be confidential information disclosed to them including, but not limited to:

Technical information: methods, processes, formulae, systems, techniques, computer programs, research projects, plans, drawings, blueprints, and design specifications

Business information: vendor lists, customer lists, constituent lists, financial data, statistical data, strategic plans, offender/releasee case files and the contents thereof, photographs, laboratory reports, charts, studies, NYSID/DIN Numbers, employee information/personnel files, all information concerning employment applicants, information relating to any victim/family of a victim and/or correspondence, social security numbers, dates of birth, drug and alcohol tests and treatment information, health and/or mental health information including but not limited to, all records subject to the laws, rules, and regulations of the Health Insurance Portability and Accountability Act of 1996 (HIPAA), rap sheets, photos and fingerprint data, documents/data not created by DOCCS, legal documents, correspondence, and litigation files, DOCCS policies, procedures and manuals, equipment used by DOCCS, or information regarding DOCCS's business dealings and relations with other parties.

2. Confidentiality

No Use. Recipient agrees not to use the Confidential Information in any way, except for the purpose of the projects or assignments they are performing for DOCCS.

No Disclosure. Recipient agrees to use its best efforts to prevent and protect the Confidential Information, or any part thereof, from disclosure to any person other than Recipient's employees and/or consultants designated by DOCCS having a need of disclosure in connection with Recipient's authorized use of the Confidential Information. This includes employees and consultants that may not

be directly working on the project or job. Recipient agrees not to disclose the nature of the work to any third party without prior written DOCCS consent. In the circumstance where the signer of this document is representing a Recipient with more than one employee, the Recipient also agrees that all of its current and future staff who may be involved in the relationship with DOCCS have been and will be instructed in the requirements of this agreement.

Protection of Secrecy. Recipient agrees to take all steps reasonably necessary to protect the secrecy of the Confidential Information, and to prevent the Confidential Information from falling into the public domain or into the possession of unauthorized persons. Such steps shall include keeping Confidential Information stored in a locked office/facility where only authorized personnel would have access.

3. Limits on Confidential Information. Confidential Information shall not be deemed proprietary and the Recipient shall have no obligation to respect such information where the information:
 - a. was known to Recipient prior to receiving any of the Confidential Information from DOCCS;
 - b. has become publicly known through no wrongful act of Recipient;
 - c. was received by Recipient without breach of this Agreement from a third party without restriction as to the use and disclosure of the information;
 - d. was independently developed by the Recipient without the use of the Confidential Information; or
 - e. was ordered to be publicly released by the requirement of a government agency or judicial proceeding.
4. Maintenance, Return, and Destruction of the DOCCS Confidential Material. Upon the DOCCS's direction, Recipient will return any Confidential Information whether electronic, paper, or other media within 48 hours of agreement termination. Returned electronic information to DOCCS must be decrypted. Copies whether electronic, paper, or other media within 48 hours of agreement termination, will be destroyed by methodology chosen by DOCCS.
5. Ownership of Confidential Information. Recipient agrees that all Confidential Information shall remain the property of DOCCS, and that DOCCS may use such Confidential Information for any purpose without obligation to Recipient. Nothing contained herein shall be construed as granting or implying any transfer of rights to Recipient in the Confidential Information. All products, whether physical or intellectual, produced in this relationship are DOCCS property and the Recipient has no rights to claim, distribute, or market such product or related DOCCS information without prior written consent from DOCCS Management, except to the degree that a valid contract between Recipient and DOCCS explicitly grants such rights. Recipient will comply with all DOCCS security policies, procedures and standards and follow best industry accepted security practices.
6. Term and Termination. This Agreement may be terminated by mutual consent. The obligations of this Agreement shall be continuing until the Confidential Information disclosed to Recipient is no longer confidential.

7. Survival of Rights and Obligations. This Agreement shall be binding upon, inure to the benefit of, and be enforceable by (a) DOCCS, its successors, and assigns; and (b) Recipient, its successors and assigns.

8. Jurisdiction and Venue: The laws of the State of New York shall govern this Agreement. If federal jurisdiction exists, we consent to exclusive jurisdiction and venue in the federal courts in Northern District of New York. If not, we each consent to the exclusive jurisdiction and venue in the Supreme Court of Albany County, New York.

9. Miscellaneous.

9.1 In the event that a portion of this Agreement is found to be unenforceable, the remainder of the Agreement shall stay in effect.

9.2 Any delay or failure of either of us to exercise a right to remedy will not result in a waiver of that, or any other right or remedy.

9.3 Each of us acknowledges that money damages may not be sufficient compensation for a breach of this Agreement. DOCCS reserves the right to receive an injunction from an appropriate New York State Court if the Agreement is breached.

9.4 In any dispute relating to this Agreement, the prevailing party will be entitled to recover reasonable attorney's fees and costs.

9.5 This agreement does not grant any implied intellectual property license to confidential information, except as stated above.

9.1 Confidential information must be encrypted in transit or at rest. Encryption methods must comply with New York State Office of Information Technology Services policy. See link: <http://www.its.ny.gov/>.

9.2 Penalty for non-compliance. Violation of this agreement could involve penalties, up to and including, relationship termination, and civil and criminal prosecution in accordance to all applicable laws.

RECIPIENT: (_____)

Name (please
print)

Signature

Title

Date

NEW YORK STATE DEPARTMENT OF CORRECTIONS AND COMMUNITY SUPERVISION

Name
(please print)

Signature

Title

Date

**Appendix J Notice of Intent to Bid & Pre-Registration for
Mandatory Pre-Bid Conference**

Notice of Intent to Bid & Pre-Registration for Mandatory Pre-Bid Conference

REQUEST FOR PROPOSALS NUMBER: RFP 2016-03	RFP TITLE: Inmate Telephone System
--	---

IF YOU INTEND TO SUBMIT A PROPOSAL, you should do the following:

- a. Complete Sections 2 and 3 of this form.
- b. Email the completed form to DOCCS at doccscontracts@doccs.ny.gov (enter *Notice of Intent to Bid—RFP 2016-03* in the subject line of the email).

IF YOU ARE NOT SUBMITTING A PROPOSAL, you should do the following:

- a. Complete Sections 1 and 3 of this form.
- b. Return the completed form to DOCCS by email at doccscontracts@doccs.ny.gov.
- c. Please indicate your reason for not submitting a proposal.

Section 1

- We do not provide the requested service/technology/commodity. Please remove our firm from your mailing list.
- We cannot submit a bid at this time because _____
- Please retain our firm on this list.

Section 2

- We intend to submit a response to this Request for Proposals

List the individuals (4 maximum) who will attend the mandatory pre-bid conference.

Pre-registration is required for attendance.

Attendee Name	Company	Phone number
1		
2		
3		
4		

Section 3: Designated Contact Person

Name of Firm: _____

Fed ID. NO.: _____ Vendor ID _____

Address 1: _____

Address 2: _____

Telephone: _____ Email: _____

Printed Name: _____ Title: _____

Date: _____

Appendix K Proposal Response Forms

Submit the completed Appendix K with the Technical Proposal.

Instructions:

1. **Read & Agree column:** Respond to each itemized section and subsection by indicating that you have read the information in the RFP and that you agree with the requirement by marking the box.
2. **Supporting Document(s) Required column:** If the section and/or subsection requires supporting documentation, a Y will appear in this column. Include the requested documents.
3. **Addressed in Proposal and/or Documents Included:** Mark the box in this column to indicate that you have addressed the section/subsection and/or have included the requested documents in your proposal.
4. **Points Awarded:** Bidders will be scored on all items for which a Y appears in this column.
5. **Complete and sign the following certification.**

The undersigned certifies that he/she

- is knowledgeable about the submitting Business Entity's business and operations;
- has read and understands all of the questions contained in the RFP and the instructions on the previous page;
- has supplied full and complete responses for every item listed on pages 2 – 7 of Appendix K *Proposal Response Form*;
- confirms, to the best of his/her knowledge, information, and belief, that the Business Entity's responses are true, accurate and complete, including all attachments; and
- understands that New York State will rely on information disclosed in this proposal when entering into a contract with the Business Entity.

Signature of Owner/Officer: _____

Printed Name of Signatory: _____

Title: _____

Name of Business: _____

Address: _____

City, State, ZIPcode: _____

Date: _____

Section	Title	Read & Agreed	Supporting Document(s) Required	Addressed in Proposal and/or Document(s) Included	Points Awarded
Section 1					
1	INTRODUCTION				
1.1	DOCCS MISSION STATEMENT				
1.2	BACKGROUND				
1.3	OVERVIEW OF EXISTING INMATE TELEPHONE SYSTEM (ITS)				
1.4	PURPOSE				
1.5	ISSUING AGENCY				
1.6	DESIGNATED CONTACTS				
1.7	SCHEDULE OF EVENTS				
Section 2					
2	BIDDER INFORMATION				
2.1	TERM OF AGREEMENT	<input type="checkbox"/>			
2.2	COMPLETENESS OF PROPOSAL	<input type="checkbox"/>			
2.3	MODIFICATION OF BIDS	<input type="checkbox"/>			
2.4	WITHDRAWAL OF BIDS	<input type="checkbox"/>			
2.5	INCURRING COSTS	<input type="checkbox"/>			
2.6	MANDATORY PRE-BID CONFERENCE	<input type="checkbox"/>	Y ²	<input type="checkbox"/>	
2.7	PRIME CONTRACTOR RESPONSIBILITY	<input type="checkbox"/>	Y ³	<input type="checkbox"/>	
2.8	BEST VALUE	<input type="checkbox"/>			

² Appendix J Notice of Intent to Bid

³ If subcontractors are used, they must be fully disclosed in the same manner as required of the prime contractor.

Section	Title	Read & Agreed	Supporting Document(s) Required	Addressed in Proposal and/or Document(s) Included	Points Awarded
2.9	TERMS/DEFINITIONS	<input type="checkbox"/>			
2.10	NYS AND DOCCS POLICIES	<input type="checkbox"/>			
Section 3					
3	SCOPE OF SERVICES	<input type="checkbox"/>			
3.1	SYSTEMS ARCHITECTURE	<input type="checkbox"/>			
3.1.1	Proposed Deployment Model	<input type="checkbox"/>		<input type="checkbox"/>	Y
3.1.2	Scalability	<input type="checkbox"/>		<input type="checkbox"/>	Y
3.1.3	Network Services	<input type="checkbox"/>			
3.1.4	System Trunking	<input type="checkbox"/>		<input type="checkbox"/>	Y
3.1.5	Call Quality	<input type="checkbox"/>		<input type="checkbox"/>	Y
3.1.6	Continuity of Services	<input type="checkbox"/>		<input type="checkbox"/>	Y
3.1.6.1	Backup	<input type="checkbox"/>		<input type="checkbox"/>	Y
3.1.6.2	Uninterruptible Power	<input type="checkbox"/>		<input type="checkbox"/>	Y
3.1.7	Single Clock Source	<input type="checkbox"/>		<input type="checkbox"/>	Y
3.1.8	Recording and Monitoring	<input type="checkbox"/>		<input type="checkbox"/>	Y
3.1.8.1	Investigative Support	<input type="checkbox"/>		<input type="checkbox"/>	Y
3.1.8.2	Simultaneous Access	<input type="checkbox"/>			
3.1.8.3	Storage	<input type="checkbox"/>			
3.1.8.4	Chain of Evidence	<input type="checkbox"/>		<input type="checkbox"/>	Y
3.1.8.5	Retrieval	<input type="checkbox"/>		<input type="checkbox"/>	Y
3.1.8.6	Equipment and Network Access	<input type="checkbox"/>		<input type="checkbox"/>	Y
3.1.8.7	Access to Recordings	<input type="checkbox"/>		<input type="checkbox"/>	Y
3.1.8.8	Call Monitoring suppression	<input type="checkbox"/>		<input type="checkbox"/>	Y
3.2	SYSTEMS MANAGEMENT	<input type="checkbox"/>			
3.2.1	Fault Management	<input type="checkbox"/>		<input type="checkbox"/>	Y

Section	Title	Read & Agreed	Supporting Document(s) Required	Addressed in Proposal and/or Document(s) Included	Points Awarded
3.2.2	Configuration Management	<input type="checkbox"/>		<input type="checkbox"/>	Y
3.2.2.1	Provisioning and Active Directory	<input type="checkbox"/>		<input type="checkbox"/>	Y
3.2.3	Accounting Management	<input type="checkbox"/>		<input type="checkbox"/>	Y
3.2.3.1	Third Party Auditing	<input type="checkbox"/>			
3.2.3.2	Call Detail Records (CDR)	<input type="checkbox"/>			
3.2.4	Performance Management	<input type="checkbox"/>		<input type="checkbox"/>	Y
3.3	MANDATORY FUNCTIONS	<input type="checkbox"/>			
3.3.1	Alert Groups	<input type="checkbox"/>	Y	<input type="checkbox"/>	Y
3.3.2	Pre-recorded Names	<input type="checkbox"/>			
3.3.3	Access to Rape Crisis Programs	<input type="checkbox"/>			
3.3.4	Access to Toll-Free Assistance Lines	<input type="checkbox"/>			
3.3.5	Announcements	<input type="checkbox"/>	Y	<input type="checkbox"/>	Y
3.3.6	Automatic Number Identification	<input type="checkbox"/>		<input type="checkbox"/>	Y
3.3.7	Billing Name and Address Lookup	<input type="checkbox"/>		<input type="checkbox"/>	Y
3.3.8	Class of Restriction (COR)	<input type="checkbox"/>		<input type="checkbox"/>	Y
3.3.9	Investigative Tip Line	<input type="checkbox"/>			
3.4	MANDATORY FEATURES	<input type="checkbox"/>			
3.4.1	Harassment Blocks	<input type="checkbox"/>		<input type="checkbox"/>	Y
3.4.2	Call Termination	<input type="checkbox"/>		<input type="checkbox"/>	Y
3.4.3	Number Control	<input type="checkbox"/>			
3.4.4	Personal Allowed Numbers (PAN)	<input type="checkbox"/>			
3.4.5	Phone Scheduler	<input type="checkbox"/>			
3.4.6	Personal Identification Numbers (PIN)	<input type="checkbox"/>			
3.4.7	Administration	<input type="checkbox"/>		<input type="checkbox"/>	Y
3.4.8	Third Party Call Detection	<input type="checkbox"/>		<input type="checkbox"/>	Y

Section	Title	Read & Agreed	Supporting Document(s) Required	Addressed in Proposal and/or Document(s) Included	Points Awarded
3.4.9	Hours of Operation	<input type="checkbox"/>			
3.4.10	Call Duration	<input type="checkbox"/>			
3.4.11	Telephone Testing	<input type="checkbox"/>			
3.4.12	Languages	<input type="checkbox"/>		<input type="checkbox"/>	Y
3.4.13	ANI Verification	<input type="checkbox"/>			
3.4.14	Telecommunications/Relay Services for the Deaf	<input type="checkbox"/>		<input type="checkbox"/>	Y
3.4.15	Telephone Accommodations for the Visually Impaired	<input type="checkbox"/>		<input type="checkbox"/>	Y
3.4.16	Call Pattern Analysis and Alerting	<input type="checkbox"/>		<input type="checkbox"/>	Y
3.4.17	Voice Recognition, Identification, and Analysis	<input type="checkbox"/>		<input type="checkbox"/>	Y
3.4.18	Emergency Shut Down	<input type="checkbox"/>		<input type="checkbox"/>	Y
3.5	EQUIPMENT	<input type="checkbox"/>			
3.5.1	Telephones	<input type="checkbox"/>			
3.5.2	Portable Phones	<input type="checkbox"/>			
3.5.3	Pedestal and Enclosures	<input type="checkbox"/>			
3.5.4	Tablets	<input type="checkbox"/>			
3.5.4.1	Device Specifications	<input type="checkbox"/>	Y	<input type="checkbox"/>	Y
3.5.5	Wiring	<input type="checkbox"/>			
3.5.6	Compliance	<input type="checkbox"/>			
3.5.7	Restoration of Facilities	<input type="checkbox"/>			
3.5.8	Inventory	<input type="checkbox"/>	Y		
3.5.9	Environmental	<input type="checkbox"/>		<input type="checkbox"/>	Y
3.5.10	Servers and Processors	<input type="checkbox"/>	Y	<input type="checkbox"/>	Y
3.5.11	New Equipment	<input type="checkbox"/>	Y	<input type="checkbox"/>	Y
3.6	SOFTWARE ENHANCEMENTS AND UPGRADES	<input type="checkbox"/>	Y	<input type="checkbox"/>	Y
3.7	MAINTENANCE	<input type="checkbox"/>		<input type="checkbox"/>	Y

Section	Title	Read & Agreed	Supporting Document(s) Required	Addressed in Proposal and/or Document(s) Included	Points Awarded
3.7.1	Maintenance Responsibility	<input type="checkbox"/>			
3.7.2	Damage	<input type="checkbox"/>			
3.7.3	Maintenance Window	<input type="checkbox"/>			
3.7.4	Maintenance Center Location	<input type="checkbox"/>			
3.7.5	Maintenance Staff Experience	<input type="checkbox"/>			
3.7.6	Preventive Maintenance	<input type="checkbox"/>			
3.7.7	Remedial Maintenance	<input type="checkbox"/>			
3.7.8	Maintenance Request Reports	<input type="checkbox"/>			
3.8	TRANSITION/MIGRATION	<input type="checkbox"/>		<input type="checkbox"/>	Y
3.8.1	Project Management	<input type="checkbox"/>	Y	<input type="checkbox"/>	Y
3.8.1.1	Project Manager	<input type="checkbox"/>			
3.8.1.2	DOCCS' Resources	<input type="checkbox"/>			
3.8.1.3	Site Survey	<input type="checkbox"/>			
3.8.2	Call Recording Migration	<input type="checkbox"/>		<input type="checkbox"/>	Y
3.8.3	Fallback Plan	<input type="checkbox"/>		<input type="checkbox"/>	Y
3.8.4	Acceptance Testing	<input type="checkbox"/>			
3.8.5	Equipment Disposal	<input type="checkbox"/>			
3.9	DATA EXCHANGE	<input type="checkbox"/>			
3.9.1	National Information Exchange Model (NIEM) Standards	<input type="checkbox"/>			
3.9.2	Data Reconciliation	<input type="checkbox"/>			
3.10	INFORMATION OWNERSHIP	<input type="checkbox"/>			
3.11	SECURITY	<input type="checkbox"/>		<input type="checkbox"/>	Y
3.11.1	ITS System Security	<input type="checkbox"/>	Y	<input type="checkbox"/>	Y
3.11.2	Jurisdiction	<input type="checkbox"/>			
3.11.3	Compliance	<input type="checkbox"/>			

Section	Title	Read & Agreed	Supporting Document(s) Required	Addressed in Proposal and/or Document(s) Included	Points Awarded
3.11.4	Background Checks	<input type="checkbox"/>			
3.11.5	Information Security Breach	<input type="checkbox"/>	Y	<input type="checkbox"/>	Y
3.12	PHASE-OUT PLAN	<input type="checkbox"/>			
3.13	TRAINING	<input type="checkbox"/>	Y	<input type="checkbox"/>	Y
3.14	DOCUMENTATION	<input type="checkbox"/>			
3.15	REPORTING	<input type="checkbox"/>	Y	<input type="checkbox"/>	Y
Section 4					
4	CUSTOMER SERVICE				
4.1	SUPPORT SERVICES FOR DOCCS				
4.1.1	Principal Technical Support Representatives	<input type="checkbox"/>			
4.1.2	Toll-Free Access	<input type="checkbox"/>			
4.1.3	DOCCS Authorized Representatives	<input type="checkbox"/>			
4.1.4	Gate Clearance	<input type="checkbox"/>			
4.1.5	Ticketing System	<input type="checkbox"/>		<input type="checkbox"/>	Y
4.1.6	DOCCS' Access to Customer Information	<input type="checkbox"/>		<input type="checkbox"/>	Y
4.1.7	Court Evidence & Expert Witness Testimony	<input type="checkbox"/>			
4.2	SUPPORT SERVICES FOR CUSTOMERS			<input type="checkbox"/>	Y
4.2.1	Toll-Free Access	<input type="checkbox"/>			
4.2.2	Executive Order Number 26	<input type="checkbox"/>			
4.2.3	Customer Account Access	<input type="checkbox"/>		<input type="checkbox"/>	Y
4.2.4	Customer Outreach	<input type="checkbox"/>			
4.2.5	Call Blocking	<input type="checkbox"/>		<input type="checkbox"/>	Y
4.2.6	Vendor Account Policies	<input type="checkbox"/>			

Section	Title	Read & Agreed	Supporting Document(s) Required	Addressed in Proposal and/or Document(s) Included	Points Awarded
4.2.7	Vendor Policy Changes	<input type="checkbox"/>			
4.2.8	Aggregated Billing Account for DOCCS-Approved Organizations	<input type="checkbox"/>	Y	<input type="checkbox"/>	Y
Section 5					
5	PERFORMANCE STANDARDS				
5.1	SERVICE OBJECTIVES	<input type="checkbox"/>		<input type="checkbox"/>	Y
5.1.1	Facility Service Objectives				
5.1.2	Customer Service Objectives				
5.2	RESOLUTION OF REPORTED PROBLEMS	<input type="checkbox"/>		<input type="checkbox"/>	Y
5.2.1	Failure to Comply				
5.2.2	Escalation Requirements				
5.3	PERFORMANCE REVIEWS	<input type="checkbox"/>	<input type="checkbox"/>		
Section 6					
6	VENDOR QUALIFICATIONS				
6.1	COMPANY EXPERIENCE	<input type="checkbox"/>	Y	<input type="checkbox"/>	Y
6.2	PAST PERFORMANCE				
6.2.1	Security Incidents	<input type="checkbox"/>		<input type="checkbox"/>	Y
6.2.2	Performance Data	<input type="checkbox"/>		<input type="checkbox"/>	Y
6.2.3	Legal Validity	<input type="checkbox"/>		<input type="checkbox"/>	Y
6.3	STAFF QUALIFICATIONS	<input type="checkbox"/>		<input type="checkbox"/>	Y
6.3.1	Staffing Numbers and Qualifications	<input type="checkbox"/>		<input type="checkbox"/>	Y
6.3.2	Staff Disqualification	<input type="checkbox"/>			
6.3.3	Staff Resignation or Discharge	<input type="checkbox"/>			
6.4	VENDOR RESPONSIBILITY	<input type="checkbox"/>			

Section	Title	Read & Agreed	Supporting Document(s) Required	Addressed in Proposal and/or Document(s) Included	Points Awarded
6.4.1	Vendor Responsibility Requirements	<input type="checkbox"/>	Y ⁴	<input type="checkbox"/>	
6.4.2	Complaint History	<input type="checkbox"/>	Y	<input type="checkbox"/>	
Section 7					
7	COMPLETE THIS SECTION SEPARATELY				
Section 8					
8	CONTRACTUAL ISSUES				
8.1	APPENDIX A/ORDER OF PRECEDENCE	<input type="checkbox"/>			
8.2	ETHICS COMPLIANCE	<input type="checkbox"/>			
8.3	PROCUREMENT LOBBYING ACT	<input type="checkbox"/>			
8.4	SALES AND COMPENSATING USE TAX CERTIFICATION REQUIREMENTS	<input type="checkbox"/>			
8.5	ENCOURAGING THE USE OF NYS BUSINESS	<input type="checkbox"/>			
8.6	DIVERSITY PRACTICES	<input type="checkbox"/>	Y ⁵	<input type="checkbox"/>	Y
8.7	MWBE AND EEO REQUIREMENTS	<input type="checkbox"/>			
8.8	Use of Service-Disabled Veteran-Owned Business Enterprises in Contract Performance	<input type="checkbox"/>			
8.9	INDEMNIFICATION	<input type="checkbox"/>			
8.10	CONTRACTOR INSURANCE REQUIREMENTS	<input type="checkbox"/>			
8.11	CONSULTANT DISCLOSURE REPORTING REQUIREMENTS	<input type="checkbox"/>			
8.12	FREEDOM OF INFORMATION LAW/TRADE SECRETS	<input type="checkbox"/>			

⁴ Appendix E *Vendor Responsibility Information* (complete online questionnaire or submit the questionnaire with Technical Proposal)

⁵ Appendix M *Diversity Practices*: Complete, sign, and include requested forms.

Section	Title	Read & Agreed	Supporting Document(s) Required	Addressed in Proposal and/or Document(s) Included	Points Awarded
8.13	EXECUTIVE ORDER 26	<input type="checkbox"/>			
8.14	EXECUTIVE ORDER 38	<input type="checkbox"/>			
8.15	PERFORMANCE/PAYMENT BOND REQUIREMENT	<input type="checkbox"/>			
8.16	LICENSED OR PATENTED COMPONENTS	<input type="checkbox"/>			
8.17	PERPETUAL LICENSE	<input type="checkbox"/>			
8.18	ESCROW OF SOFTWARE	<input type="checkbox"/>			
8.19	BREACH OF SERVICES	<input type="checkbox"/>			
8.20	GENERAL REQUIREMENTS	<input type="checkbox"/>			
8.21	EQUIPMENT AND LICENSES UPON TERMINATION	<input type="checkbox"/>			
8.21.1	Agency Termination	<input type="checkbox"/>			
8.21.2	Procurement Lobbying Termination	<input type="checkbox"/>			
8.22	CONTRACT TERMS	<input type="checkbox"/>			
8.23	NONDISCLOSURE AGREEMENT	<input type="checkbox"/>			
8.24	CONTRACT PROVISIONS	<input type="checkbox"/>			
8.25	POTENTIAL ANNUAL REVENUE PAYMENTS	<input type="checkbox"/>			
8.26	INMATE SECURE MESSAGING OPTION	<input type="checkbox"/>			

Section	Title	Read & Agreed	Supporting Document(s) Required	Addressed in Proposal and/or Document(s) Included	Points Awarded
Section 9					
9	ADMINISTRATIVE PROCEDURES				
9.1	COMMUNICATION WITH DOCCS	<input type="checkbox"/>			
9.2	PROCUREMENT RIGHTS	<input type="checkbox"/>			
9.3	PROPOSAL FORMAT, PACKAGING, & SUBMISSION	<input type="checkbox"/>			
9.3.1	Proposal Content (Pass/Fail)	<input type="checkbox"/>			
9.3.2	Other Legal Documents	<input type="checkbox"/>			
9.3.3	Technical Proposal	<input type="checkbox"/>			
9.3.4	Cost Proposal	<input type="checkbox"/>			
9.3.5	Diversity Practices Questionnaire (2 Points)	<input type="checkbox"/>			
9.4	PROPOSAL EVALUATION	<input type="checkbox"/>			
9.4.1	Mandatory Requirements (Pass/Fail)	<input type="checkbox"/>			
9.4.2	Technical Evaluation (93 Points)	<input type="checkbox"/>			
9.4.3	Cost Evaluation (5 Points)	<input type="checkbox"/>			
9.4.4	Composite Scores	<input type="checkbox"/>			
9.4.5	Debriefings	<input type="checkbox"/>			

Appendix L Performance/Payment Bond: Sample Bond

**PERFORMANCE
AND
PAYMENT BOND: SAMPLE
STATE FINANCE LAW §137**

KNOW ALL PERSONS BY THESE PRESENTS, that

(hereinafter call the "Principal") and (hereinafter call the "Surety") are held and firmly bound to the New York State Department of Corrections and Community Supervision (hereinafter "DOCCS") in the full and just sum of Ten million dollars (\$10,000,000) good and lawful money of the United States of America, for the payment of which sum of money, well and truly to be made and done, the Principal binds itself, its heirs, executors, administrators, successors and assigns and the Surety binds itself, its successors and assigns, jointly and severally, firmly by these presents.

WHEREAS, the Principal has entered into a certain written Contract No. _____ bearing date on the _____ day of _____ 20__, with DOCCS for the provision of services, a copy of which Contract is annexed to and hereby made part of this Bond as though herein set forth in full;

NOW, THEREFORE, the conditions of this obligation are such that if the Principal, its representatives or assigns, shall well and faithfully comply with and perform all the terms, covenants and conditions of said Contract on its part to be kept and performed and all modifications, amendments, additions and alterations thereto that may hereafter be made, according to the true intent and meaning of said Contract,

including the payment of money, the repair and/or replacement of defective work, guarantees of maintenance for the periods stated in the Contract, and payment of all lawful claims to all persons furnishing labor

or materials to the Principal or his subcontractors in the prosecution of the contract work and shall fully indemnify and save harmless DOCCS from all cost and damage which it may suffer by reason of failure so to do, and shall fully reimburse and repay DOCCS for all outlay and expense which DOCCS may incur in making good any such default, and shall protect said DOCCS against, and pay any and all amounts, damages, costs and judgments which may or shall be recovered against said DOCCS or its trustees, officers, agents or employees or which said DOCCS may be called upon to pay to any person or corporation by reason of any damages arising or growing out of the doing of said work, the repair or maintenance thereof, or the manner of doing the same, or the neglect of the said Principal, or its agents, or the improper performance of the said work by the said Principal, or its agents, or the infringement of any patent or patent rights by reason of the use of any materials furnished or work done as aforesaid or otherwise, then this obligation shall be null and void, otherwise to remain in full force and effect;

PROVIDED, HOWEVER, the said Surety, for value received, hereby stipulates and agrees, if requested to do so by DOCCS, to fully perform and complete the work mentioned and described in said Contract, pursuant to the terms, conditions, and covenants thereof, if for any cause the Principal fails or neglects to so fully perform and complete such payments and work and the Surety further agrees to commence such payment and work of completion within ten (10) calendar days after written notice

thereof from DOCCS and to bring such payment current and to complete such work within ten (10) calendar days from the expiration of the time allowed the Principal in the Contract for the payment or completion thereof; and further

PROVIDED, HOWEVER, and with respect only to items of work other than payment of money, surety may obtain a bid or bids for submission to DOCCS for completing the work, and further

PROVIDED, HOWEVER, the Surety, for value received, for itself and its successors and assigns, hereby stipulates and agrees that the obligation of said Surety and its Bond shall be in no way impaired or affected by an extension of time, modification, omission, addition, or change in or to the said Contract or the work to be performed thereunder, or by any payment thereunder before the time required therein, or by any waiver of any provisions thereof, or by any assignment, subletting or other transfer of any work to be performed or any monies due or to become due thereunder or by DOCCS' takeover, use, occupancy or operation of any part or all of the work covered by the Contract; and said Surety does hereby waive notice of any and all of such extensions, modifications, omissions, additions, changes, payments, waivers, assignments, subcontracts,

transfers, takeovers, uses, occupancies or operations, and hereby expressly stipulates and agrees that any and all things done and omitted to be done by and in relation to assignees, subcontractors, and other transferees shall have the same effect as to said Surety as though done or omitted to be done by or in relation to said Principal, and further

PROVIDED, HOWEVER, no right of action shall accrue on this bond to or for the use of any person or corporation other than DOCCS named herein, its heirs, executors, administrators or successors, and those furnishing labor, products or materials to the Principal or his subcontractors in the prosecution of the contract work.

PROVIDED, HOWEVER, regardless of the number and total claims, in no event shall the surety be liable in the aggregate for more than \$-----

PROVIDED, HOWEVER, any suit under this bond must be instituted before the expiration of two (2) years from the date on which the contract ends.

IN WITNESS WHEREOF, the Principal has hereunto set its hand and seal and the Surety has caused this instrument to be signed by its attorney-in-fact, and its corporate seal to be hereunto affixed this _____ day of _____, 20__.

By: _____ (If Corporation, affix Corporate Seal)
Principal

By: _____ (If Corporation, affix Corporate Seal)

Appendix M Diversity Practices Questionnaire

Diversity Practices Questionnaire

I, _____, as _____ (title) of _____ firm or company (hereafter referred to as the company), swear and/or affirm under penalty of perjury that the answers submitted to the following questions are complete and accurate to the best of my knowledge:

1. Does your company have a Chief Diversity Officer or other individual who is tasked with supplier diversity initiatives? Yes or No

If Yes, provide the name, title, description of duties, and evidence of initiatives performed by this individual or individuals.

(Attach additional sheets to this questionnaire; number items on the sheets to correspond with the numbers on this questionnaire.)

2. What percentage of your company's gross revenues (from your prior fiscal year) was paid to New York State certified minority and/or women-owned business enterprises as subcontractors, suppliers, joint-venturers, partners or other similar arrangement for the provision of goods or services to your company's clients or customers?
-

3. What percentage of your company's overhead (i.e. those expenditures that are not directly related to the provision of goods or services to your company's clients or customers) or non-contract-related expenses (from your prior fiscal year) was paid to New York State certified minority- and women-owned business enterprises as suppliers/contractors?⁶
-

4. Does your company provide technical training⁷ to minority- and women-owned business enterprises? Yes or No

If Yes, provide a description of such training which should include, but not be limited to, the date the program was initiated, the names and the number of minority- and women-owned business enterprises participating in such training, the number of years such training has been offered and the number of hours per year for which such training occurs.

(Attach additional sheets to this questionnaire; number items on the sheets to correspond with the numbers on this questionnaire.)

5. Is your company participating in a government approved minority- and women-owned business enterprise mentor-protégé program? Yes or No

⁶ Do not include onsite project overhead.

⁷ Technical training is the process of teaching employees how to more accurately and thoroughly perform the technical components of their jobs. Training can include technology applications, products, sales and service tactics, and more. Technical skills are job-specific as opposed to soft skills, which are transferable.

Diversity Practices Questionnaire

If Yes, identify the governmental mentoring program in which your company participates and provide evidence demonstrating the extent of your company's commitment to the governmental mentoring program.

(Attach additional sheets to this questionnaire; number items on the sheets to correspond with the numbers on this questionnaire.)

6. Does your company include specific quantitative goals for the utilization of minority- and women-owned business enterprises in its non-government procurements?
Yes or No

If Yes, provide a description of such non-government procurements (including time period, goal, scope and dollar amount) and indicate the percentage of the goals that were attained.

(Attach additional sheets to this questionnaire; number items on the sheets to correspond with the numbers on this questionnaire.)

7. Does your company have a formal minority- and women-owned business enterprise supplier diversity program?
Yes or No

If Yes, provide documentation of program activities and a copy of policy or program materials.

8. Does your company plan to enter into partnering or subcontracting agreements with New York State certified minority- and women-owned business enterprises if selected as the successful respondent?
Yes or No

If Yes, complete the attached Utilization Plan.

All information provided in connection with the questionnaire is subject to audit and any fraudulent statements are subject to criminal prosecution and debarment.

Signature of
Owner/Official

Printed Name of
Signatory

Diversity Practices Questionnaire

Title _____

Name of Business _____

Address _____

City, State, Zip _____

STATE OF _____
COUNTY OF _____) ss:

On the _____ day of _____, 201____, before me, the undersigned, a Notary Public in and for the State of _____, personally appeared _____, personally known to me or proved to me on the basis of satisfactory evidence to be the individual whose name is subscribed to this certification and said person executed this instrument.

Notary Public



Attachment A Map of NYS Correctional Facilities





NEW YORK STATE DEPARTMENT OF CORRECTIONS AND COMMUNITY SUPERVISION FACILITIES AND REGIONAL MAP

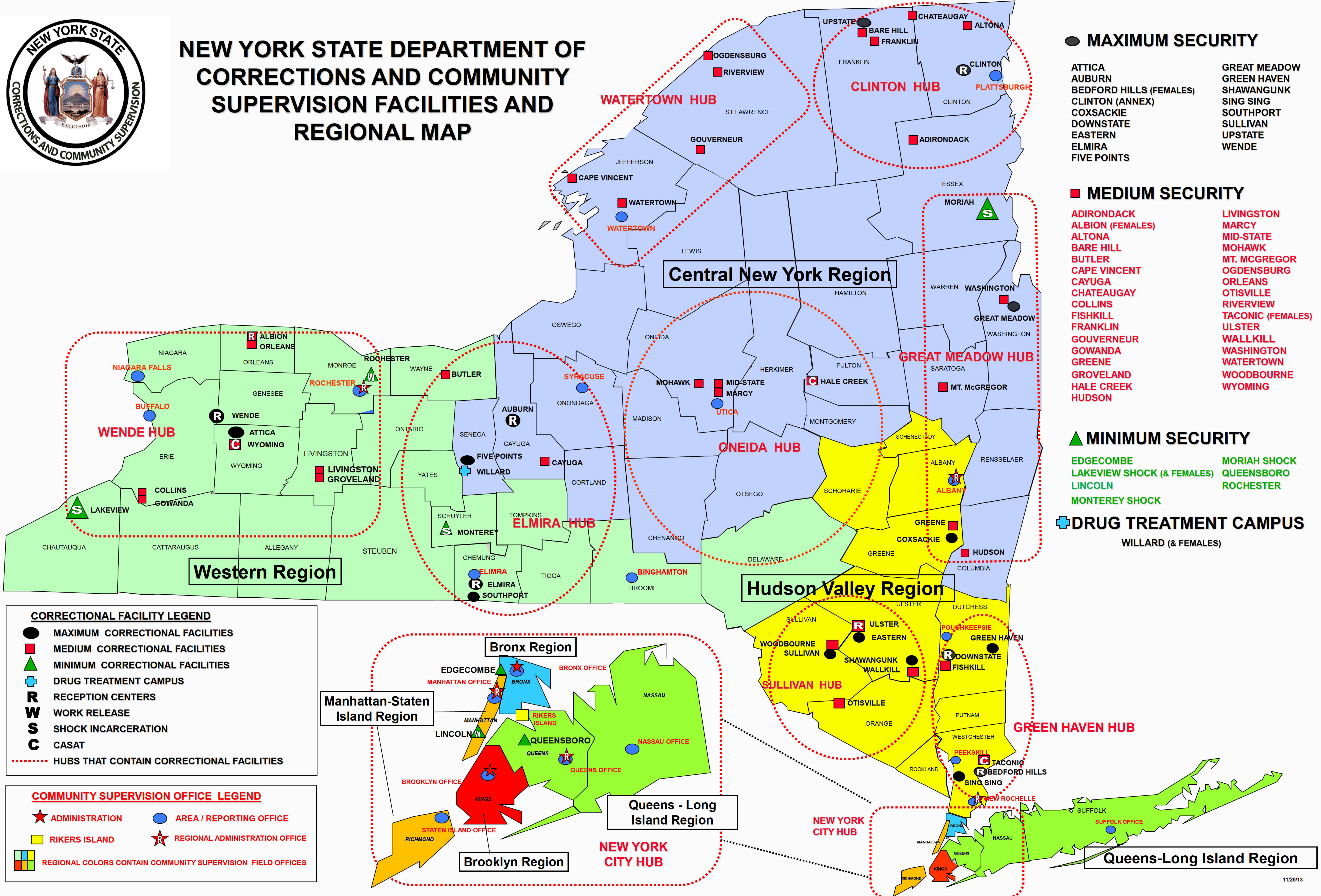

● MAXIMUM SECURITY

- | | |
|-------------------------|--------------|
| ATTICA | GREAT MEADOW |
| AUBURN | GREEN HAVEN |
| BEDFORD HILLS (FEMALES) | SHAWANGUNK |
| CLINTON (ANNEX) | SING SING |
| COXSACKIE | SOUTHPORT |
| DOWNSTATE | SULLIVAN |
| EASTERN | UPSTATE |
| ELMIRA | WENDE |
| FIVE POINTS | |

■ MEDIUM SECURITY

- | | |
|------------------|-------------------|
| ADIRONDACK | LIVINGSTON |
| ALBION (FEMALES) | MARCY |
| ALTONA | MID-STATE |
| BARE HILL | MOHAWK |
| BUTLER | MT. MCGREGOR |
| CAPE VINCENT | OGDENSBURG |
| CAYUGA | ORLEANS |
| CHATEAUGAY | OTISVILLE |
| COLLINS | RIVERVIEW |
| FISHKILL | TACONIC (FEMALES) |
| FRANKLIN | ULSTER |
| GOUVERNEUR | WALLKILL |
| GOWANDA | WASHINGTON |
| GREENE | WATERTOWN |
| GROVELAND | WOODBOURNE |
| HALE CREEK | WYOMING |
| HUDSON | |

▲ MINIMUM SECURITY

- | | |
|----------------------------|--------------|
| EDGECOMBE | MORIAH SHOCK |
| LAKEVIEW SHOCK (& FEMALES) | QUEENSBORO |
| LINCOLN | ROCHESTER |
| MONTEREY SHOCK | |

⊕ DRUG TREATMENT CAMPUS

WILLARD (& FEMALES)

CORRECTIONAL FACILITY LEGEND

- MAXIMUM CORRECTIONAL FACILITIES
- MEDIUM CORRECTIONAL FACILITIES
- ▲ MINIMUM CORRECTIONAL FACILITIES
- ⊕ DRUG TREATMENT CAMPUS
- R RECEPTION CENTERS
- W WORK RELEASE
- S SHOCK INCARCERATION
- C CASAT
- HUBS THAT CONTAIN CORRECTIONAL FACILITIES

COMMUNITY SUPERVISION OFFICE LEGEND

- ★ ADMINISTRATION
- AREA / REPORTING OFFICE
- RIKERS ISLAND
- ★ REGIONAL ADMINISTRATION OFFICE
- REGIONAL COLORS CONTAIN COMMUNITY SUPERVISION FIELD OFFICES

Attachment B NYS DOCCS Population and Phone Detail

Addresses, Security Levels, Gender, Average Population and Number of Inmate Phones

Facility Address	Security Level	Gender	Average Daily Population	Total Number of Phones	Facility Code
Adirondack Correctional Facility 196 Ray Brook Rd, Box 110 Ray Brook, New York 12977-0110 (518) 891-1343 (Essex County)	Med	Male	396	48	230
Albion Correctional Facility 3595 State School Road Albion, New York 14411-9399 (585) 589-5511 (Orleans County)	Med	Female	1026	69	090
Altona Correctional Facility 555 Devils Den Road, P.O. Box 3000 Altona, New York 12910-2090 (518) 236-7841 (Clinton County)	Med	Male	471	31	540
Attica Correctional Facility 639 Exchange St Attica, New York 14011-0149 (585) 591-2000 (Wyoming County)	Max	Male	2088	106	000
Auburn Correctional Facility 135 State Street Auburn, New York 13021-1800 (315) 253-8401 (Cayuga County)	Max	Male	1642	132	010
Bare Hill Correctional Facility 181 Brand Road, Caller Box #20 Malone, New York 12953-0020 (518) 483-8411 (Franklin County)	Med	Male	1621	108	560
Bedford Hills Correctional Facility 247 Harris Road Bedford Hills, New York 10507-2400 (914) 241-3100 (Westchester Co.)	Max	Female	797	49	120
Cape Vincent Correctional Facility 36560 Rte. 12E, PO Box 599 Cape Vincent, New York 13618-0599 (315) 654-4100 (Jefferson County)	Med	Male	859	65	580

Facility Address	Security Level	Gender	Average Daily Population	Total Number of Phones	Facility Code
Cayuga Correctional Facility 2202 State Rte. 38A, P.O. Box 1150 Moravia, New York 13118-1150 (315) 497-1110 (Cayuga County)	Med	Male	820	67	550
Clinton Correctional Facility 1156 Route 374, P.O. Box 2000 Dannemora, New York 12929-2000 (518) 492-2511 (Clinton County)	Max	Male	2748	150	020
Collins Correctional Facility P.O. Box 490, Middle Rd Collins, New York 14034-0490 (716) 532-4588 (Erie County)	Med	Male	890	60	470
Coxsackie Correctional Facility Box 200, 11260 Rte. 9W West Coxsackie, New York 12051-0200 (518) 731-2781 (Greene County)	Max	Male	929	120	130
Downstate Correctional Facility 121 Red Schoolhouse Rd, P.O. Box 445 Fishkill, New York 12524-0445 (845) 831-6600 (Dutchess County)	Max	Male	1169	55	240
Eastern Correctional Facility 30 Institution Rd Napanoch, New York 12458-0338 (845) 647-7400 (Ulster County)	Max	Male	916	83	100
Edgecombe Correctional Facility 611 Edgecombe Avenue New York, New York 10032-4398 (212) 923-2575 (New York County)	Min Res Treatment	Male and Female	109	8	320
Elmira Correctional Facility PO Box 500, 1879 Davis St Elmira, New York 14902-0500 (607) 734-3901 (Chemung County)	Max	Male	1731	118	110
Fishkill Correctional Facility 18 Strack Drive Beacon, New York 12508-0307 (845) 831-4800 (Dutchess County)	Med	Male	1455	112	050

Facility Address	Security Level	Gender	Average Daily Population	Total Number of Phones	Facility Code
Five Points Correctional Facility Caller Box 400 6600 State Route 96 Romulus, New York 14541 (607) 869-5111 (Seneca County)	Max	Male	1394	182	370
Franklin Correctional Facility 62 Bare Hill Road, P.O. Box 10 Malone, New York 12953-0010 (518) 483-6040 (Franklin County)	Med	Male	1636	95	530
Gouverneur Correctional Facility 112 Scotch Settlement Road, PO Box 370 Gouverneur, New York 13642- 0370 (315) 287-7351 (St. Lawrence County)	Med	Male	801	64	810
Gowanda Correctional Facility P.O. Box 350, South Road Gowanda, New York 14070-0350 (716) 532-0177 (Erie County)	Med	Male	1479	81	450
Great Meadow Correctional Facility 11739 State Route 22, P.O. Box 51 Comstock, New York 12821 (518) 639-5516 (Washington County)	Max	Male	1596	100	040
Green Haven Correctional Facility 594 Route 216 Stormville, New York 12582 (845) 221-2711 (Dutchess County)	Max	Male	1926	129	080
Greene Correctional Facility 165 Plank Road, P. O. Box 8 Coxsackie, New York 12051-0008 (518) 731-2741 (Greene County)	Med	Male	1585	72	670
Groveland Correctional Facility 7000 Sonyea Road Sonyea, New York 14556 (585) 658-2871 (Livingston County)	Med	Male	1074	59	460
Hale Creek ASACTC 279 Maloney Road Johnstown, New York 12095 (518) 736-2094 (Fulton County)	Med	Male	308	22	850

Facility Address	Security Level	Gender	Average Daily Population	Total Number of Phones	Facility Code
Hudson Correctional Facility 50 E. Court Street, Box 576 Hudson, New York 12534-0576 (518) 828-4311 (Columbia County)	Med	Male	379	35	270
Lakeview Shock Incarceration Correctional Facility 9300 Lake Avenue, P.O. Box T Brocton, New York 14716 (716) 792-7100 (Chautauqua County)	Min	Male and Female	740	31	600
Lincoln Correctional Facility 31-33 West 110th Street New York, New York 10026-4398 (212) 860-9400 (New York County)	Min	Male	65	8	360
Livingston Correctional Facility 7005 Sonyea Road, P.O. Box 49 Sonyea, New York 14556-0049 (585) 658-3710 (Livingston County)	Med	Male	809	39	800
Marcy Correctional Facility 9000 Old River Road, P.O. Box 5000 Marcy, New York 13403 (315) 768-1400 (Oneida County)	Med	Male	1169	90	490
Mid-State Correctional Facility 9005 Old River Road, P.O. Box 216 Marcy, New York 13403-0216 (315) 768-8581 (Oneida County)	Med	Male	1377	91	480
Mohawk Correctional Facility 6514 Route 26 Rome, New York 13440 (315) 339-5232 (Oneida County)	Med	Male	1397	105	390
Moriah Shock Incarceration Correctional Facility 75 Burhart Lane, P.O. Box 999 Mineville, New York 12956-0999 (518) 942-7561 (Essex County)	Min	Male	190	15	510
Ogdensburg Correctional Facility One Correction Way Ogdensburg, New York 13669-2288 (315) 393-0281 (St. Lawrence County)	Med	Male	376	31	350

Facility Address	Security Level	Gender	Average Daily Population	Total Number of Phones	Facility Code
Orleans Correctional Facility 3595 Gaines Basin Road Albion, New York 14411 (585) 589-6820 (Orleans County)	Med	Male	792	64	640
Otisville Correctional Facility 57 Santorium Road, Box 8 Otisville, New York 10963-0008 (845) 386-1490 (Orange County)	Med	Male	578	45	290
Queensboro Correctional Facility 47-04 Van Dam Street Long Island City, NY 11101-3081 (718) 361-8920 (Queens County)	Min	Male	344	32	170
Riverview Correctional Facility 1110 Tibbits Drive, P.O. Box 158 Ogdensburg, New York 13669 (315) 393-8400 (St. Lawrence County)	Med	Male	803	50	570
Rochester Correctional Facility 470 Ford Street Rochester, New York 14608-2499 (585) 454-2280 (Monroe County)	Min	Male	35	4	300
Shawangunk Correctional Facility 200 Quick Road, P. O. Box 750 Wallkill, New York 12589-0750 (845) 895-2081 (Ulster County)	Max	Male	499	47	680
Sing Sing Correctional Facility 354 Hunter Street Ossining, New York 10562-5442 (914) 941-0108 (Westchester County)	Max	Male	1540	114	070
Southport Correctional Facility P.O. Box 2000, Bob Masia Drive Pine City, New York 14871 (607) 737-0850 (Chemung County)	Max	Male	747	40	630
Sullivan Correctional Facility Box 116, 325 Riverside Drive Fallsburg, New York 12733-0116 (845) 434-2080 (Sullivan County)	Max	Male	463	51	690

Facility Address	Security Level	Gender	Average Daily Population	Total Number of Phones	Facility Code
Taconic Correctional Facility 250 Harris Road Bedford Hills, New York 10507-2498 (914) 241-3010 (Westchester County)	Med	Female	346	29	251
Ulster Correctional Facility P.O. Box 800, 750 Berme Road Napanoch, New York 12458 (845) 647-1670 (Ulster County)	Med	Male	795	49	610
Upstate Correctional Facility P.O. Box 2000, 309 Bare Hill Road Malone, New York 12953 (518) 483-6997 (Franklin County)	Max	Male	276	42	840
Wallkill Correctional Facility 50 McKenderick Road, Box G Wallkill, New York 12589-0286 (845) 895-2021 (Ulster County)	Med	Male	575	43	060
Washington Correctional Facility Box 180, 72 Lock 11 Lane Comstock, New York 12821-0180 (518) 639-4486 (Washington County)	Med	Male	735	42	650
Watertown Correctional Facility 23147 Swan Road Watertown, New York 13601-9340 (315) 782-7490 (Jefferson County)	Med	Male	538	50	030
Wende Correctional Facility 3040 Wende Road Alden, New York 14004-1187 (716) 937-4000 (Erie County)	Max	Male	868	95	430
Willard Drug Treatment Center P.O. Box 303, 7116 County Route 132 Willard, New York 14588 (607) 869-5500 (Seneca County)	Drug Treatment Center	Male and Female	695	47	820
Woodbourne Correctional Facility 99 Prison Road, P.O. Box 1000 Woodbourne, New York 12788 (845) 434-7730 (Sullivan County)	Med	Male	817	56	140

Facility Address	Security Level	Gender	Average Daily Population	Total Number of Phones	Facility Code
Wyoming Correctional Facility P.O. Box 501, 3203 Dunbar Road Attica, New York 14011 (585) 591-1010 (Wyoming County)	Med	Male	1633	75	660
North Pearl	N/A	N/A	N/A	24	N/A

ATTACHMENT C PROPOSAL SUBMISSION CHECKLIST AND REQUIRED DOCUMENTS

**Proposal Submission Checklist and
Required Documents**

Required documents	Type of Submission	Include with Bid Submission	Include with Contract Materials
Pass/Fail Checklist (Section 9.3.1)	<ol style="list-style-type: none"> 1. Completed and signed <i>Application Cover Sheet and Individual, Corporation, Partnership, or LLC Acknowledgment</i> (within Attachment C). Return as cover sheet and second page for the Technical Proposal. 2. Procurement Lobbying Certification (within Attachment C) Include two originals 3. Appendix K, <i>Proposal Response Forms</i>, and the Technical Response Narrative: two (2) originals, plus eight copies, plus one electronic copy in PDF format on an electronic medium. 4. Appendix H, <i>Cost Proposal Form</i>: two (2) original signed <i>Cost Proposal Forms</i> with attachments submitted in a separate sealed and labeled envelope 5. Appendix M, Diversity Questionnaire: two (2) original completed, signed, and notarized questionnaires with attached sheets submitted in a separate sealed and labeled envelope 	<input type="checkbox"/> <input type="checkbox"/>	
Vendor Responsibility Questionnaire (Appendix E)	Complete online version using the OSC VendRep System at http://www.osc.state.ny.us/vendrep/vendor_index.htm , or download the latest version and submit a completed and signed original with the Technical Proposal: http://osc.state.ny.us/vendrep/forms_vendor.htm	<input type="checkbox"/>	
M/WBE and EEO Requirements (Appendix C)	<p>Download and sign completed forms as specified in Appendix C. Return the Staffing Plan, the Utilization Plan, and the EEO Policy Statement.</p> <p>Bidders may request Word versions of the forms for ease of completion or access the forms on the Community Supervision Web site: http://www.doccs.ny.gov/RFPs/rfps.html</p>	<input type="checkbox"/>	

**Proposal Submission Checklist and
Required Documents**

Required documents	Type of Submission	Include with Bid Submission	Include with Contract Materials
Completed Encouraging NYS Business form (Section 8.5)	Complete form in Attachment C	<input type="checkbox"/>	
Vendor Reference Form (Appendix F) and Section 6.1	Include three separate references on forms provided in Appendix F of this document. (Subcontractors must also complete three separate references.)	<input type="checkbox"/>	
Staff Qualification Form (Appendix G)	Complete a separate form for each proposed staff person and attach a full résumé. Complete three (3) References forms for each qualified staff member.	<input type="checkbox"/>	
Non-Disclosure Agreement (Appendix I)	Recipient agrees not to use the Confidential Information in any way, except for the purpose of the projects or assignments they are performing for DOCCS.		<input type="checkbox"/>
Performance/ Payment Bond (Appendix L)	Review the information in Section 8.14. DOCCS requires the Contractor to furnish without cost to DOCCS a performance/payment bond as security for the faithful performance of the Contract.		<input type="checkbox"/>
Consultant Disclosure (Attachment C & Section 8.10)	Form A should be submitted at the time of contract; Form B is filed annually by May 15.		<input type="checkbox"/>

Proposal Submission Checklist and Required Documents

Required documents	Type of Submission	Include with Bid Submission	Include with Contract Materials
Form ST-220-CA (Section 8.4)	All Bidder should be prepared to verify compliance with NYS Tax Law: http://www.tax.ny.gov/pdf/publications/sales/pub223.pdf	<input type="checkbox"/>	<input type="checkbox"/>
Completed Workers' Compensation and Disability Forms (Section 8.9)	Complete and return with Contract documentation Workers' Compensation - http://www.wcb.ny.gov/content/onlineforms/obtainC105.jsp Disability Benefits - http://www.wcb.ny.gov/content/onlineforms/obtainDB120-1.jsp	<input type="checkbox"/>	<input type="checkbox"/>
	Attachment C documents that are due for submission with proposals should be included with the Technical Proposal.	<input type="checkbox"/>	

Application Cover Sheet

NYS Department of Corrections and Community Supervision

RFP 2016-02, Inmate Telephone System

Return this page with the Technical Proposal as Cover Sheet.

Applicant Legal Name: _____

Contact Person: _____

Business Address: _____

Phone: _____ **E-Mail Address:** _____

Fax: _____ **Website Address:** _____

Federal ID#: _____ **NYS Vendor ID#:** _____

Submitted By:

Name of Authorized Official: _____

Title of Authorized Official: _____

Signature of Authorized Official: _____

Date: _____

Note: Signature binds applicant to a firm offer for a 120-day period from the date of the submission.

Procurement Lobbying Certification

By signing, the Offerer/bidder affirms that it understands and agrees to comply with the NYS Department of Corrections and Community Supervision (DOCCS) procedures relative to permissible contacts, as required by State Finance Law §139-j and §139-k.

Procurement Lobbying information can be accessed using the following links:

<http://www.ogs.ny.gov/aboutogs/regulations/advisoryCouncil/sfl139-j.htm> and
<http://www.ogs.ny.gov/aboutogs/regulations/advisoryCouncil/sfl139-k.htm>

Offerer affirms that it understands and agrees to comply with the procedures of DOCCS relative to permissible Contacts as required by State Finance Law §139-j (3) and §139-j (6) (b).

By: _____ Date: _____

Name: _____ Title: _____

1 Contractor Name: _____

Contractor Address: _____

Prior Non-Responsibility Determinations – State Finance Law §139-k

1. Has any Government Entity made a finding of non-responsibility against this organization/company? No Yes

2. If yes, was the basis for the finding of non-responsibility due to a violation of SFL§139-j or due to the intentional provision of false or incomplete information to a Government Entity?

No Yes

3. Has any Government Entity terminated or withheld a procurement contract with this organization/company due to the intentional provision of false or incomplete information?

No Yes

If yes to any of the above questions, provide complete details on a separate page and attach.

Offerer Certification:

I certify that all information provided to DOCCS with respect to State Finance Law §139-k is complete, true and accurate.

By: _____ Date: _____

Name: _____ Title: _____

Procurement Lobbying Termination

DOCCS reserves the right to terminate this contract in the event it is found that the certification filed by the Offerer/bidder in accordance with New York State Finance Law §139-k was intentionally false or intentionally incomplete. Upon such finding, DOCCS may exercise its termination right by providing written notice to the Offerer/bidder in accordance with the written notification terms of the contract.

ENCOURAGING USE OF NEW YORK STATE BUSINESSES IN CONTRACT PERFORMANCE

New York State businesses have a substantial presence in State Contracts and strongly contribute to the economies of the state and the nation. In recognition of their economic activity and leadership in doing business in New York State, Bidders for this contract for commodities, services or technology are strongly encouraged and expected to consider New York State businesses in the fulfillment of the requirements of the Contract. Such partnering may be as subcontractors, suppliers, protégés or other supporting roles. Bidders need to be aware that all authorized users of this Contract will be strongly encouraged, to the maximum extent practical and consistent with legal requirements, to use responsible and responsive New York State businesses in purchasing commodities that are of equal quality and functionality and in utilizing services and technology. Furthermore, Bidders are reminded that they must continue to utilize small, minority and women-owned businesses, consistent with current State law.

Utilizing New York State businesses in State Contracts will help create more private sector jobs, rebuild New York's infrastructure, and maximize economic activity to the mutual benefit of the Contractor and its New York State business partners. New York State businesses will promote the Contractor's optimal performance under the Contract, thereby fully benefiting the public sector programs that are supported by associated procurements.

Public procurements can drive and improve the State's economic engine through promotion of the use of New York businesses by its Contractors. The State, therefore, expects Bidders to provide maximum assistance to New York businesses in their use of the Contract. The potential participation by all kinds of New York businesses will deliver great value to the State and its taxpayers.

Bidders can demonstrate their commitment to the use of New York State businesses by responding to the question below:

Will New York State Businesses be used in the performance of this Contract? _____
Yes _____ No

If yes, identify New York State Business(es) that will be used; (Attach identifying information).

OSC CONSULTANT DISCLOSURE REPORTING REQUIREMENTS

CONTRACTOR INSTRUCTIONS

Background:

Pursuant to New York State Finance Law Section 163(4)(g), state agencies must require all contractors, including subcontractors, that provide consulting services for State purposes pursuant to a contract to submit an annual employment report for each such contract, such report to include for each employment category within the contract: (i) the number of employees employed to provide services under the contract, (ii) the number of hours they work, and (iii) their total compensation under the contract. Consulting services are defined as analysis, evaluation, research, training, data processing, computer programming, engineering, environmental, health, and mental health services, accounting, auditing, paralegal, legal, or similar services.

Contractors selected for award on the basis of a procurement issued by OSC (Request for Proposals, Mini-Bid, or Invitation for Bids) must complete **Form A, State Consultant Services – Contractor’s Planned Employment from Contract Start Date through the End of the Contract Term** upon notification of award. The completed **Form A** must include information for all employees that will be providing services under the contract, whether employed by the contractor or by a subcontractor.

Contractors selected for award are also required to complete **Form B, State Consultant Services Contractor’s Annual Employment Report** annually for each year of the contract term, on a State fiscal year basis. The first report is due on May 15 for the period April 1 through March 31.

Form A must be submitted to DOCCS as the contracting agency, and Form B must be submitted to DOCCS (as the contracting agency), the Department of Civil Service, and the Consultant Reporting Section of the Bureau of Contracts at OSC, at the addresses provided in these instructions.

Form A, State Consultant Services – Contractor’s Planned Employment from Contract Start Date through the End of the Contract Term and **Form B, State Consultant Services Contractor’s Annual Employment Report**, are attached to these instructions. Please see these instructions for further information regarding completion and submission of the forms.

INSTRUCTIONS

FORM A:

Upon notification of contract award, use **Form A, State Consultant Services Contractor’s Planned Employment From Contract Start Date Through the End of the Contract Term**, attached to these instructions, to report the necessary planned employment information prospectively from the start date through the end of the contract term. This is a one-time reporting requirement.

Complete **Form A** for contracts for consulting services in accordance with the following:

- **Employment category:** the specific occupation(s), as listed in the O*NET occupational classification system, which best describe the employees anticipated to be providing services under the contract.

(Note: Access the O*NET database, which is available through the US Department of Labor’s Employment and Training Administration, on-line at www.online.onetcenter.org to find a list of occupations.)

- **Number of employees:** the total number of employees in the employment category anticipated to be employed to provide services under the contract, including part time employees and employees of subcontractors.
- **Number of hours to be worked:** the total number of hours anticipated be worked by the employees in the employment category.
- **Amount payable under the contract:** the total amount payable by the State to the State contractor under the contract, for work by the employees in the employment category, for services provided during the Report Period.

Submit completed **Form A** within 48 hours of notification of selection for award to DOCCS (as the contracting agency) at the address listed below.

INSTRUCTIONS

FORM B:

Use **Form B, State Consultant Services Contractor's Annual Employment Report**, attached to these Instructions, to report the annual employment information required by the statute. This form will capture historical information, detailing actual employment data for the most recently concluded State fiscal year (April 1 – March 31). Submit **Form B** to DOCCS (as the contracting Agency), the Department of Civil Service (DCS), and to the Consultant Reporting Section of the Bureau of Contracts at OSC at the addresses listed below.

Complete **Form B** for contracts for consulting services in accordance with the following:

- **Scope of Contract:** a general classification of the single category that best fits the predominate nature of the services provided under the contract.
- **Employment Category:** the specific occupation(s), as listed in the O*NET occupational classification system, which best describe the employees providing services under the contract.

(Note: Access the O*NET database, which is available through the US Department of Labor's Employment and Training Administration, on-line at www.online.onetcenter.org to find a list of occupations.)

- **Number of Employees:** the total number of employees in the employment category employed to provide services under the contract during the Report Period, including part time employees and employees of subcontractors.
- **Number of hours worked:** the total number of hours **worked** during the Report Period by the employees in the employment category.
- **Amount Payable under the Contract:** the total amount paid or payable by the State to the State contractor under the contract, for work by the employees in the employment category, for services provided during the Report Period.

Submit the completed Form B annually by May 15th for each State fiscal year (or portion thereof) the contract is in effect, as follows:

To DOCCS (as the contracting Agency):

By mail: Sandra Downey, Director of Budget & Finance
NYS Department of Corrections & Community Supervision
Harriman State Campus/Building #2
1220 Washington Avenue
Albany, NY 12226-2050

By email: dccscontracts@dccs.ny.gov

To the Consultant Reporting Section of the Bureau of Contracts at OSC:

By mail: NYS Office of the State Comptroller
Bureau of Contracts
110 State Street, 11th Floor
Albany, NY 12236

By fax: Attn: Consultant Reporting
(518) 474-8030 or (518) 473-8808

To DCS:

By mail: NYS Department of Civil Service
Alfred E. Smith Office Building
Albany, NY 12239

OSC Use Only:
 Reporting Code:
 Category Code:
 Date Contract Approved:

FORM A

State Consultant Services - Contractor's Planned Employment
 From Contract Start Date Through The End Of The Contract Term

State Agency Name: Department of Corrections & Community Supervision
 Contractor Name: _____ Agency Code: 10160
 Contract Start Date: / / Contract Number: _____
 Contract End Date: / /

Employment Category	Number of Employees	Number of hours to be worked	Amount Payable Under the Contract
Total this page	0	0	\$ 0.00
Grand Total			

Name of person who prepared this report: _____
 Title: _____ Phone #: _____
 Preparer's Signature: _____
 Date Prepared: / /
 (Use additional pages, if necessary) Page of

FORM B

OSC Use Only:

Reporting Code:

Category Code:

State Consultant Services
Contractor's Annual Employment Report
Report Period: April 1, to March 31,

Contracting State Agency Name: Dept. of Corrections & Community Supervision Agency Code: 10160
 Contract Number:
 Contract Term: / / to / /
 Contractor Name:
 Contractor Address:
 Description of Services Being Provided:

Scope of Contract (Choose one that best fits):
 Analysis Evaluation Research Training
 Data Processing Computer Programming Other IT consulting
 Engineering Architect Services Surveying Environmental Services
 Health Services Mental Health Services
 Accounting Auditing Paralegal Legal Other Consulting

Employment Category	Number of Employees	Number of Hours Worked	Amount Payable Under the Contract
Total this page	0	0	\$ 0.00
Grand Total			

Name of person who prepared this report:
 Preparer's Signature: _____
 Title: _____ Phone #: _____
 Date Prepared: / /

Use additional pages if necessary)

Page of

Attachment D Data Exchange Specifications

1.0 Daily Exchanges

1.1 General Description

The NYS Department of Corrections and Community Supervision (DOCCS) and the ITS vendor interact to exchange a variety of information. On a nightly basis, DOCCS provides information concerning inmates entering and leaving DOCCS, inmates' authorized call lists, and inmates restricted from placing calls. The vendor provides the details for the call detail records from the previous day, both complete and incomplete.

DOCCS provides the facility location of each inmate in its population on a nightly basis. Hourly updates are also available during normal operation hours.

On a one-time basis for start-up purposes, DOCCS will provide the vendor with a full start-up dataset that includes all the files in the formats indicated for daily changes as described in the following pages.

The data exchanges specified in this Attachment D represent the current processing concepts and file layouts. Changes and/or additions may be necessary based on the additional functionality to be provided. DOCCS will coordinate with the selected vendor to define those changes and/or additions upon contract award.

1.2 Concepts

The ITS operated by the vendor provides for call blocking by inmate. This requires the maintenance of a file of phone numbers that each inmate is allowed to call and the authorization code (PIN) for each inmate. DOCCS "Locator" system records information concerning each inmate's admission to and release from DOCCS. Admission and release transactions will be passed to the vendor each night as inmate adds and deletes. To reduce abuse of these "auth codes," the codes will be deleted from the vendor authorization file upon an inmate's release.

DOCCS operates a computer application that records and collects data concerning inmates' phone calls. The Phone Number Registration subsystem records the phone numbers each inmate is allowed to call. Each inmate is allowed to register 15 phone numbers, all others are blocked by the ITS. Any changes to inmate allowed call lists will be sent to the vendor each night via FTP or some other agreed upon transfer protocol. Modifications to the call list will be sent as add, delete or replace transactions.

DOCCS inmate "Disciplinary" system records among other penalties the loss of the privilege to use the ITS. A file of phone privilege restrictions will be sent to the vendor nightly. These transactions will contain the date that the restrictions expire. An ancillary system to associate phones by ANI to specific locations within specific facilities is also maintained. File transfer of ANI location file changes will also be done on a nightly basis following the file transfer of inmate change transactions.

A nightly file of all inmates under custody along with their current facility location will be sent after the inmate and ANI file transfer to reconcile each inmate's current location. The vendor will receive hourly updates during the day of all changes to inmates location that have occurred since the last hourly update or the last nightly "Undercustody" file send was completed.

In return, the vendor must provide a call detail file to the DOCCS' computer each night. This file, containing the dates, times, auth-codes, phone numbers, elapsed times, etc. for each call including uncompleted calls, will be posted to an application file to allow inquiry and reporting by authorized DOCCS users to determine calling patterns of an individual inmate or to a specified phone number.

1.3 DOCCS to Vendor Data Exchange

1.3.1 PIN

Every inmate is assigned an eight digit numeric authorization code or Personal Identification Number (PIN) to input prior to entering the called phone number. This PIN is derived from the inmate's DOCCS Department ID Number (DIN) as described below:

- PIN = YYNNSSSS where
- YY = Year portion of the inmate's DIN
- NN = Alpha portion of the inmate's DIN converted to the ordinal position of the letter in the alphabet.
- SSSS= sequence number portion of the inmate's DIN

1.3.2 Nightly Batch Files

Following normal end-of-night processing for inmate systems, DOCCS will prepare and transmit the following three files to the vendor: Inmate information change file, ANI change file, and Inmate undercustody location file.

1.3.2.1 Inmate Information Change File

This file consists of three transaction types: Inmate changes, Restriction changes, and Phone number changes. Although each transaction type may be prepared separately, all three transaction types will be merged into a single file with mixed record formats detailed at the end of this document. The transaction file will be in auth code (PIN) order within transaction type. The transaction types are in the order stated above. The vendor must process the transactions in the order provided. All translation of DINs to PINs will be done as part of the file preparation.

1.3.2.1.1 Adds/Deletes/Replaces

Inmate transaction types consist of an Add, Delete or Replace transaction. Adds and Deletes are based upon the DOCCS' Locator System admission and release/discharge transactions that were entered during the day. Replace transactions are generated by a change in an inmate's Hearing Impaired Indicator. On any given day there will be no more than one Inmate transaction per PIN.

1.3.2.1.2 Restrictions

Restriction transaction types consist of an Add, Delete, or Replace transaction. These transactions will come from the DOCCS' Inmate Disciplinary System. The restriction end date is supplied on each transaction. These records will be used to temporarily block the use of the ITS from those inmates with penalty dates. The penalty expiration must be checked by the vendor and the restriction removed from the vendor's authorization file on a nightly basis, when the expiration date has been reached. This will ensure that on those occasions when file transfer is unsuccessful, an inmate whose restriction expired the day before will be allowed to make calls on the first day he/she should be allowed. On any given day there will be no more than one Restriction transaction per PIN.

1.3.2.1.3 Phone Number Changes

Phone Number transaction types consist of an Add, Delete or Replace transaction.

These transactions come from the Phone Number Registration part of the DOCCS' ITS.

On any given day an inmate may have any number of Phone Number Add, Delete and/or Replace transactions.

1.3.2.2 ANI Change File

This file consists of Adds and Deletes of ANI phone numbers. ANIs are phones within the DOCCS facilities from which inmates are allowed to make calls. These ANI phone numbers differ from normal phone numbers in that the middle three digits, usually the exchange, is actually DOCCS' three digit facility code in which the ANI is located. Each ANI phone is assigned a class of service level, which determines what rules are to be applied to the inmates placing calls from these phones. See the record layout and service level definitions for more detail. On any given day there may or may not be any ANI transaction records. A file will always be sent, containing a Header and Trailer record, even if there are no Detail records.

1.3.2.3 Inmate Undercustody Location File

This file consists of one record for each inmate who is under custody on the DOCCS Locator System, including PIN and current facility location, at the time the file is created. This is not a file of transactions like the Inmate and ANI files. It is a static file of the inmate population at the given point in time. This file is used by the vendor to reconcile each inmate's current DOCCS facility location.

1.3.3 Hourly Batch Files During Normal Operation

1.3.3.1 Locator Change File

During each hour of normal operations, DOCCS will write all inmate location changes that occurred since the last hourly update to a file and transfer it to the vendor. Upon the first update of the day, all location changes since the previous night's Inmate Undercustody Location file transfer are written. This temporary file is in the same format as the nightly location file, with a Header and Trailer record. The vendor must process these updates so that inmates can call from their new location within an hour of entry of the DOCCS Locator transaction recording the arrival.

1.3.4 Exchange Requirements

Each of the three nightly files has a Header record as the first record of the file and a Trailer record as the last record of the file. The data portion of each file is labeled as a Detail record. There may be none or many Detail records in each file. If the file transfer is unsuccessful for either the Inmate Information Change file or the ANI Change file, the next day's data will be appended to the end of the file. In this way, each day's transactions will be accumulated until a successful file transfer has been completed. It should be noted that if either of these files contains more than one day's worth of transactions, there will be a Header and Trailer record for each day. No attempt is made to consolidate multiple days' transactions within one Header and Trailer. The vendor's program on the receiving end must be prepared to process a file with multiple Header-Details-Trailer sequences of data.

The Inmate Undercustody Location file does not get appended to the next night, if the file transfer is unsuccessful. Because this is a static file, each nightly create overwrites the previous night's file. This file will always contain only one file in Header-Details-Trailer format.

1.3.5 Sequence Requirements

The Inmate Information Change file is the first file transferred each night. The transactions in this file must be processed in the order in which they are received by the vendor. The ANI file is the second file transferred each night. This file should also be processed in the order in which it is received by the vendor. After the first two files have been processed by the vendor, the third file to be transferred

is the Inmate Undercustody Location file. This file is to be used by the vendor to reconcile the facility location for each PIN. This file should be the last file processed each night by the vendor.

1.4 Vendor to DOCCS Data Exchange

Each night the vendor will transmit to DOCCS a file of call detail information for all attempted and completed calls for the day just ended. The call detail file will be used to provide online inquiry and reports on the call details. The inquiries and reports will be used primarily to answer two basic questions: (1) What phone numbers did a particular inmate call? **and** (2) Which inmates called a particular number or numbers? The call detail file will be posted to a DB2 table on the DOCCS computer by a nightly batch program. Auth codes (PINS) will be translated to DINs before the posting process.

The Call Detail file received from the vendor shall begin with a Header record and end with a Trailer record. The accompanying record layout provides the necessary information required. A listing of incomplete call reason codes follows the record layout.

If the transfer of the Call Detail file is unsuccessful, attempts will be made to receive it during the day. Only one day's worth of call details should be on a file. If call details from a previous day are not transmitted, no attempts should be made to accumulate two days' worth into one file. The vendor should keep the past seven days' worth of Call Detail files as history, and **available** to DOCCS to receive in the event nightly processing is disrupted and call details must be recovered from a previous day.

1.5 Inmate Information Transmission File Layout

Header Record Format

REC POSITION	PICTURE	Field description – value
01 - 03	X (03)	Record type - 'HDR'
04 - 09	9 (06)	C.O.B. Date (yymmdd)
10 - 16	X (07)	Filler
17 - 19	9 (03)	Company number - 100 (for usan)
20 - 29	X (10)	Company name - 'usan'
30 - 37	X (08)	Filler spaces
38 - 43	X (06)	File name - 'inmate'
44 - 48	X (05)	Filler space

Detail Record Format

REC POSITION	PICTURE	FIELD DESCRIPTION - VALUE
01 - 03	X (03)	RECORD TYPE - 'DTL'
04 - 11	9 (08)	AUTH CODE (PIN)
12 - 12	X (01)	TRANS TYPE I = INMATE P = PHONE # R = RESTRICTION
13 - 13	X (01)	TRANSACTION A = ADD D = DELETE R = REPLACE (ALL TRANS TYPE)
14 - 27	X (14)	DETAIL INFO (DEPENDENT ON TRANS TYPE) IF TYPE=I - ZERO FILLED IF TYPE=P - PHONE # (NPANXXYYYYBBBB) NPA = AREA CODE NXX = EXCHANGE YYYY = EXTENSION BBBB = SPACES IF TYPE=R - EXPIRATION DATE (CCYYMMDD000000)
28 - 28	X (01)	HEARING IMPAIRED INDICATOR (FOR TYPE I ONLY) IF TYPE=I 1=HEARING IMPAIRED PIN 2=TTY ENABLED PIN BLANK=NEITHER 1 OR 2 NOTE: FIELD IS BLANK FOR TYPE P & R
29 - 29	X (01)	TTY/TRS INDICATOR (FOR TYPE P ONLY) IF TYPE=P 1=TTY PHONE # 2=TRS PHONE # BLANK=NON TTY/TRS PHONE # NOTE: FIELD IS BLANK FOR TYPE I & R
30 - 48	X (19)	FILLER SPACES

Inmate Information Transmission File Layout**Trailer Record Layout**

REC POSITION	PICTURE	FIELD DESCRIPTION – VALUE
01 - 03	X (03)	RECORD TYPE - 'TRL'
04 - 09	9 (06)	C.O.B. DATE (YYMMDD)
10 - 16	X (07)	FILLER
17 - 19	9 (03)	COMPANY NUMBER - 100 (FOR USAN)
20 - 29	X (10)	COMPANY NAME - 'USAN
30 - 37	9 (08)	RECORD COUNT (INCLUDING HEADER & TRAILER)
38 - 43	X (06)	FILE NAME - 'INMATE'
44 - 48	X (05)	FILLER SPACES

1.6 ANI Transmission File Layout**Header Record Format**

REC POSITION	PICTURE	FIELD DESCRIPTION – VALUE
01 - 03	X (03)	RECORD TYPE - 'HDR'
04 - 09	X (06)	C.O.B. DATE (YYMMDD)
10 - 16	X (07)	FILLER – SPACES
17 - 19	9 (03)	COMPANY NUMBER - 100 (FOR USAN)
20 - 29	X (10)	COMPANY NAME - 'USAN
30 - 37	X (08)	FILLER – SPACES
38 - 43	X (06)	FILE NAME - 'ANI'
44 - 80	X (37)	FILLER – SPACES

Detail Record Format

REC POSITION	PICTURE	FIELD DESCRIPTION – VALUE
01 - 03	X (03)	RECORD TYPE - 'DTL'
04 - 13	9 (10)	ANI PHONE NUMBER (AAASSSNNNN) AAA = AREA CODE SSS = SITE CODE NNNN = TRUNK NUMBER
14 - 16	X (03)	FACILITY CODE
17 - 28	X (12)	FACILITY NAME
29 - 44	X (16)	ANI LOCATION
45 - 45	X (01)	RECEPTION INDICATOR – SPACE
46 - 50	X (05)	AUDIO LINE
51 - 51	X (01)	TRANSACTION TYPE A = ADD D = DELETE
52 - 52	X (01)	CLASS OF SERVICE '1' THROUGH '5'
53 - 53	X (01)	TTY INDICATOR (Y OR BLANK)
54 - 80	X (27)	FILLER – SPACES

ANI Transmission File Layout

Trailer Record Layout

REC POSITION	PICTURE	FIELD DESCRIPTION – VALUE
01 - 03	X (03)	RECORD TYPE - 'TRL'
04 - 09	X (06)	C.O.B. DATE (YYMMDD)
10 - 16	X (07)	FILLER – SPACES
17 - 19	X (03)	COMPANY NUMBER - 100 (FOR USAN)
20 - 29	X (10)	COMPANY NAME - 'USAN
30 - 37	9 (08)	RECORD COUNT (INCLUDING HEADER & TRAILER)
38 - 43	X (06)	FILE NAME - 'ANI
44 - 80	X (37)	FILLER – SPACES

Record Layouts

ANI Phone Registration – Class of Service Levels

LEVEL	DEFINITION
1 (Default)	PIN Required
	Calling List Required
	Disciplinary Hold Applies
2	PIN Required
	Calling List Required
	Disciplinary Hold NOT Applied
3	PIN Required
	Calling List NOT Required
	Disciplinary Hold Applies
4	PIN Required
	Calling List NOT Required
	Disciplinary Hold NOT Applied
5	PIN NOT Required
	Calling List NOT Required
	Disciplinary Hold NOT Applied

1.7 Undercustody Location File Layout

Header Record Format

REC POSITION	PICTURE	FIELD DESCRIPTION - VALUE
01 - 03	X (03)	RECORD TYPE - 'HDR'
04 - 09	9 (06)	C.O.B DATE (YYMMDD)
10 - 16	X (07)	FILLER SPACES
17 - 19	9 (03)	COMPANY NUMBER - 100 (FOR USAN)
20 - 29	X (10)	COMPANY NAME - 'USAN
30 - 37	X (08)	FILLER SPACES
38 - 43	X (06)	FILENAME - 'LOCATOR'
44 - 48	X (05)	FILLER SPACES

Detail Record Format

REC POSITION	PICTURE	FIELD DESCRIPTION - VALUE
01 - 03	X (03)	RECORD TYPE - 'DTL'
04 - 11	9 (08)	PIN NUMBER
12 - 13	X (02)	FACILITY CODE
14 - 14	X (01)	POSSIBLE FUTURE USE (SUBDIVISION CODE)
15 - 48	X (34)	FILLER SPACE

Trailer Record Layout

REC POSITION	PICTURE	FIELD DESCRIPTION - VALUE
01 - 03	X (03)	RECORD TYPE - 'TRL'
04 - 09	9 (06)	C.O.B. DATE (YYMMDD)
10 - 16	X (07)	FILLER SPACES
17 - 19	9 (03)	COMPANY NUMBER - 100 (FOR USAN)
20 - 29	X (10)	COMPANY NAME - 'USAN
30 - 37	9 (08)	RECORD COUNT (INCLUDING HEADER & TRAILER)
38 - 43	X (06)	FILENAME - 'LOCATOR'
44 - 48	X (05)	FILLER SPACES

1.8 Locator Change File Layout

Header Record Format

REC POSITION	PICTURE	FIELD DESCRIPTION - VALUE
01 - 03	X (03)	RECORD TYPE - 'HDR'
04 - 09	9 (06)	C.O.B DATE (YYMMDD)
10 - 16	X (07)	FILLER SPACES
17 - 19	9 (03)	COMPANY NUMBER - 100 (FOR USAN)
20 - 29	X (10)	COMPANY NAME - 'USAN
30 - 37	X (08)	FILLER SPACES
38 - 43	X (06)	FILENAME - 'LOCCHG'
44 - 48	X (05)	FILLER SPACES

Detail Record Format

REC POSITION	PICTURE	FIELD DESCRIPTION - VALUE
01 - 03	X (03)	RECORD TYPE - 'DTL'
04 - 11	9 (08)	PIN NUMBER
12 - 13	X (02)	FACILITY CODE
14 - 14	X (01)	POSSIBLE FUTURE USE (SUBDIVISION CODE)
15 - 48	X (34)	FILLER SPACE

Trailer Record Layout

REC POSITION	PICTURE	FIELD DESCRIPTION - VALUE
01 - 03	X (03)	RECORD TYPE - 'TRL'
04 - 09	9 (06)	C.O.B. DATE (YYMMDD)
10 - 16	X (07)	FILLER SPACES
17 - 19	9 (03)	COMPANY NUMBER - 100 (FOR USAN)
20 - 29	X (10)	COMPANY NAME - 'USAN
30 - 37	9 (08)	RECORD COUNT (INCLUDING HEADER & TRAILER)
38 - 43	X (06)	FILENAME - 'LOCCHG'
44 - 48	X (05)	FILLER SPACES

1.9 Call Detail Transmission File Layout

Header Record Format

REC POSITION	PICTURE	FIELD DESCRIPTION – VALUE
01 - 03	X (03)	RECORD TYPE - 'HDR'
04 - 09	9 (06)	C.O.B DATE (YYMMDD)
10 - 16	X (07)	FILLER SPACES
17 - 19	9 (03)	COMPANY NUMBER - 100 (FOR USAN)
20 - 29	X (10)	COMPANY NAME -'USAN
30 - 80	X (51)	FILLER SPACES

Detail Record Format

REC POSITION	PICTURE	FIELD DESCRIPTION – VALUE
01 - 03	X (03)	RECORD TYPE - 'DTL'
04 - 11	9 (08)	CALLING DATE (CCYYMMDD)
12 - 21	9 (10)	ANI PHONE NUMBER (AAASSSNNNN) AAA = AREA CODE SSS = SITE CODE (FACILITY CODE) NNNN = TRUNK NUMBER
22 - 35	X (14)	PHONE CALLED (NPANXXYYYYBBBB) NPA = AREA CODE NXX = EXCHANGE YYYY = EXTENSION BBBB = SPACES
36 - 49	X (14)	BILLING NUMBER (NPANXXYYYYBBBB)
50 - 55	9 (06)	TIME CALLED (HHMMSS)
66 - 61	9 (06)	ELAPSED TME (MMMMSS)
62 - 63	9 (02)	CALL TYPE (00 OR 01)
64 - 64	X (01)	BILLABLE (Y OR N)
65- 72	X (08)	PIN (8 DIGIT PIN)
73 - 73	X (01)	LOCAL (L OR N)
74 - 75	X (02)	INCOMPLETE CODE (BLANK FOR COMPLETED CALLS)
76 - 77	X (02)	THIRD PARTY CALL DETECT COUNTER
78 - 78	X (01)	THIRD PARTY CALL DETECT ACTION
79 - 79	X (01)	RECORDING INDICATOR (A, B OR BLANK)
80 - 80	X (01)	TTY/TRS INDICATOR (1=TTY, 2=TRS, OR BLANK)

Call Detail Transmission File Layout

Trailer Record Layout

REC POSITION	PICTURE	FIELD DESCRIPTION - VALUE
01 - 03	X (03)	RECORD TYPE - 'TRL'
04 - 09	9 (06)	C.O.B. DATE (YYMMDD)
10 - 16	X (07)	FILLER SPACES
17 - 19	9 (03)	COMPANY NUMBER - 100 (FOR USAN)
20 - 29	X (10)	COMPANY NAME - 'USAN
30 - 37	9 (08)	RECORD COUNT (INCLUDING HEADER & TRAILER)
38 - 80	X (43)	FILLER SPACES

Call Detail File – Incomplete Call Reasons

CODE	DEFINITION
01	Global Block - person called and asked not to get collect calls from Inmates.
02	Call not made during operating hours.
03	NY Telephone or some other telephone company has a block on the Number - usually due to nonpayment.
04	Invalid PIN - inmate punched in a PIN # that could not be validated.
05	Number dialed was not on the inmate's active Personal Calling List.
06	Inmate denied phone privileges by DOCCS for disciplinary reasons.
07	Historical.
08	Inmate hung up during the initial hold period.
09	Public Pay Phone.
10-13	MCI/Support Operations Issue.
14	Busy - party called was already on the line.
15	Party called was not home or failed to pick up within 6 rings.
16	Inmate hung up while party called was listening to message.
17	Party called declined the collect call.
18	Historical.
19	MCI/Support Operations Issue.
20	7 Day Window for self-learning has expired.

CODE	DEFINITION
21	List Full. Not allowed. Inmate called new number while on self-learning.
22	Limit of 6 non-accepted calls to a number was exceeded.
23	Unable to validate. Could not access validation server.
24	DOCCS Security Block.
25	Customer requested block.
26	VAC non-payment block.
27	VAC tease block.
28	PIN # not registered at facility.
29	Validation server responded with error.
30	Account Suspended - VAC restriction due to depleted credit.
31	Extra digits dialed.
32	Technical issue.
33	Inmate dialed 0.
34-35	MCI issue.
36	Invalid number dialed.
38	PIN search failed.
39	PIN in use.

2.0 Weekly Exchanges

2.1 Vendor to DOCCS Data Exchange

Each week on Sunday morning, the vendor will transmit to DOCCS a file for Inmate data reconciliation. DOCCS will reconcile their data with the vendors' data. Any exception will be transmitted back to the vendor in the same format as the daily Inmate Information Transmission File.

2.2 Weekly Inmate Reconciliation File Layout

Record Layout

REC POSITION	PICTURE	FIELD DESCRIPTION – VALUE
01 - 08	X (08)	INMATE PIN
09-09	X(01)	FILLER SPACE
10 -19	9(10)	REGISTERED PHONE NUMBER PHONE#(AAABBBCCCC) AAA=AREACODE BBB=EXCHANGE CCCC=EXTENSION SPACE FILL WHEN INDICATING THAT AN INMATE HAS A PHONE RESTRICTION FOR THE INITIAL RESTRICTION RECORD. FOR EACH ADDITIONAL RECORD, PROVIDE EACH SPECIFIC PHONE NUMBER THAT INMATE HAS REGISTERED, BUT CAN NOT TEMPORARLY CALL DUE TO A RESTRICTION. SPACE FILL FOR INITIAL INMATE PHONE REGISTRATION RECORD. FOR EACH ADDITIONAL RECORD, INDICATING EACH SPECIFIC PHONE NUMBER THAT INMATE HAS REGISTERED ACTUAL PHONE NUMBER IS TO BE PROVIDED.
20 – 24	X (05)	FILLER SPACES
25 - 25	X (01)	RESTRICTION VALUE 'R' OR 'Y' FOR RESTRICTION TRANSACTIONS VALUE 'U' FOR INMATE PHONE NUMBER REGISTRATION TRANSACTIONS
26 - 28	X 03)	FILLER SPACES
29- 36	9 (08)	RESTRICTION END DATE – CCYYMMDD FORMAT ZERO FILLED WHEN NOT APPLICABLE
37 – 41	X (05)	FILLER SPACES
42 – 42	X(01)	HEARING IMPAIRED INDICATOR
43 – 43	X(01)	FILLER SPACES
44 – 44	X(01)	TTY/TRS INDICATOR
45 – 45	X(01)	FILLER SPACES
46 – 53	X(08)	DATE ADDED – CCYYMMDD FORMAT

3.0 Monthly Exchanges

3.1 Vendor to DOCCS Data Exchange

Each month the vendor will transmit to DOCCS a file of all inmate calls made and billed for a given month. Vendor has 3 months to get all billed calls to DOCCS. For example, in January vendor will send file of calls made and billed in October of the previous year.

3.2 Monthly Billing Reconciliation File Layout

Record Layout

REC POSITION	PICTURE	FIELD DESCRIPTION – VALUE
01 - 11	X(11)	RECORD ID
12-22	9(11)	FILLER - ZERO FILL
23 -25	X(03)	CALL TYPE CRE=CREDIT-COLLECT DIR=DIRECT-BILL PRE=PRE-PAY BNB=BILLABLE, BUT NOT BILLED
26 – 33	9 (08)	CALL DATE – CCYYMMDD FORMAT
34 - 34	9 01)	FILLER - ZERO FILL
35- 40	9 (06)	CALL TIME – HHMMSS FORMAT
41 – 45	9 (05)	CALL DURATION – MMMMM (MINUTES) FORMAT
46 – 48	9(03)	CALL DURATION – SSS (SECONDS) FORMAT
49 – 55	9(07)	CHARGES – 9999999 - FORMAT
56 – 56	9(01)	FILLER - ZERO FILL
57 – 61	9(05)	SURCHARGE – 99999 FORMAT - ZERO FILL WHEN NOT APPLICABLE
62 – 66	9(05)	FILLER - ZERO FILL
67– 76	9(10)	CALLED FROM PHONE NUMBER PHONE#(AAABBBCCCC) AAA=AREACODE BBB=EXCHANGE CCCC=EXTENSION
77 – 84	9(08)	FILLER - ZERO FILL
85 – 94	9(10)	PHONE NUMBER CALLED PHONE#(AAABBBCCCC) AAA=AREACODE BBB=EXCHANGE CCCC=EXTENSION
95 - 106	X(12)	FACILITY NAME AND STATE

**ATTACHMENT E RANGE OF ACADEMIC CAPABILITIES FOR
TABLETS**

NYS Department of Corrections and Community Supervision
Range of Academic Capabilities for Tablets

The contents of the tablets should provide a range of academic capabilities. Materials in the following major categories are required for the requested phone tablets:

Educational Materials:

Literacy Materials must cover all levels of readability and be available in Spanish at the following levels:

- **Low-level reading materials** for ABE and inmates with limited English proficiency. These materials should encompass basic vocabulary, short paragraphs, and simple sentences.
- **Mid-level reading materials** with longer selections and more complex ideas.
- **Upper-level reading materials** that require higher level thinking skills, include complex ideas, and be longer in length.

These materials should be comprised of books, texts, or passages.

Mathematics: Content must include very basic concepts such as the following:

- Operations of addition, subtraction, multiplication of whole numbers
- More advanced concepts such as algebra, probability, problem solving skills, etc.

Educational Games

Games should be educational in nature such as, but not limit to, the following:

- Problem solving
- Crosswords
- Word search

Religion

Provide content as outlined on the attached table.

NYS Department of Corrections and Community Supervision
Range of Academic Capabilities for Tablets

Major Religion	Texts (Visual & Audio for each is recommended)
Asatru (Odinist/Wotanist)	Books on the religion (3-5)
Buddhist	Books on the religion and meditation (3-5)
Greek Orthodox	<ul style="list-style-type: none"> • Bible • Liturgical books of the Orthodox Church
Hindu	<ul style="list-style-type: none"> • Vedas: the Rig Veda, Sama Veda, Yajur Veda • Atharva Veda Bhagavad Gita (Both are required)
Islam	<ul style="list-style-type: none"> • The Hadith, The meanings of the Noble Qur'an is allowed. • 2010 version by Dr. Muhammad Taqi-ud-Din Al-Hilali and Dr. Muhammad Muhsin Khan-Darussalam • Qur'ans by other authors are allowed as well. • (Both Qur'an and Hadith are required.)
Jehovah's Witnesses	<ul style="list-style-type: none"> • Bible (New World Translation) • The Watch Tower • The Awake
Jewish	<ul style="list-style-type: none"> • Torah • Talmud and prayer books • Books of Judaism
Moorish Science Temple	<ul style="list-style-type: none"> • Holy Koran • Oral statements of Prophet Noble Drew Ali • Divine Constitution and by-laws • Mufty law books • Branch Temple information • Moorish-American newspaper • Moorish Science literature
Mormon	<ul style="list-style-type: none"> • King James Bible • Book of Mormon • The Doctrine and Covenants • The Pearl of Great Price • Ensign, a monthly church magazine • Gospel Principles, a church publication
Nation of Gods and Earths	<ul style="list-style-type: none"> • 120 Degrees, The Supreme Alphabet and Mathematics (DOCCS-approved version) • Five Percenter newspaper • History of Allah • Talmud
Nation of Islam	<ul style="list-style-type: none"> • Final Call newspaper • History of Islam • History of the Nation of Islam • Books on Louis Farrakhan, Ward Fard, and Elijah Muhammad
Native American	<ul style="list-style-type: none"> • The Constitution of the Five Nation • Traditional Teachings • Clanology • Basic Call to Consciousness • Thanks Giving Address: Greeting to the Natural World Roots of the Iroquois

NYS Department of Corrections and Community Supervision
Range of Academic Capabilities for Tablets

Major Religion	Texts (Visual & Audio for each is recommended)
Protestant	<ul style="list-style-type: none"> • Bible • Missal/Hymnal • Prayer book • Books on Christianity • Christian Music
Quakers	<ul style="list-style-type: none"> • Bible
Rastafarian	<ul style="list-style-type: none"> • Holy Piby • King James Bible • Kebra Negast • Books on Rastafari Movement, Bob Marley, Haile Selassie, Marcus Garvey, Ethiopia, Empress Menen • Reggae Music
Santeria	<ul style="list-style-type: none"> • Books on Santeria religion • Books on Santeria Orishas (Both are required)
Seventh Day Adventists	<ul style="list-style-type: none"> • Bible
Shetaut Neter	<ul style="list-style-type: none"> • Neterian Spirituality and Shetaut Neter Chant, Songbook, Meditation and Devotional Worship Manual • Shetaut Neter African Religion • Principles of African Religion
Sikh	<ul style="list-style-type: none"> • Prayer book called a Gutka • Books on the Religion
Wicca	<ul style="list-style-type: none"> • Book of Shadows • Books on the Religion



Corrections and Community Supervision

ANDREW M. CUOMO
Governor

ANTHONY J. ANNUCCI
Acting Commissioner

Addendum I to RFP 2016-02, Inmate Telephone System

Vendor Assurance of No Conflict of Interest or Detrimental Effect

The Firm offering to provide services pursuant to this Request for Proposals 2016-02, *Inmate Telephone System*, as a contractor, joint venture contractor, subcontractor, or consultant, attests that its performance of the services outlined in this RFP does not and will not create a conflict of interest with nor position the Firm to breach any other contract currently in force with the State of New York.

Furthermore, the Firm attests that it will not act in any manner that is detrimental to any State project on which the Firm is rendering services. Specifically, the Firm attests that:

1. The fulfillment of obligations by the Firm, as proposed in the response, does not violate any existing contracts or agreements between the Firm and the State;
2. The fulfillment of obligations by the Firm, as proposed in the response, does not and will not create any conflict of interest, or perception thereof, with any current role or responsibility that the Firm has with regard to any existing contracts or agreements between the Firm and the State;
3. The fulfillment of obligations by the Firm, as proposed in the response, does not and will not compromise the Firm's ability to carry out its obligations under any existing contracts between the Firm and the State;
4. The fulfillment of any other contractual obligations that the Firm has with the State will not affect or influence its ability to perform under any contract with the State resulting from this RFP;
5. During the negotiation and execution of any contract resulting from this RFP 2016-02, the Firm will not knowingly take any action or make any decision which creates a potential for conflict of interest or might cause a detrimental impact to the State as a whole including, but not limited to, any action or decision to divert resources from one State project to another;

Addendum I to RFP 2016-02, Inmate Telephone System

6. In fulfilling obligations under each of its State contracts, including any contract which results from this RFP 2016-02, the Firm will act in accordance with the terms of each of its State contracts and will not knowingly take any action or make any decision which might cause a detrimental impact to the State as a whole including, but not limited to, any action or decision to divert resources from one State project to another;
7. No former officer or employee of the State who is now employed by the Firm, nor any former officer or employee of the Firm who is now employed by the State, has played a role with regard to the administration of this contract procurement in a manner that may violate section 73(8)(a) of the State Ethics Law; and
8. The Firm has not and shall not offer to any employee, member or director of the State any gift, whether in the form of money, service, loan, travel, entertainment, hospitality, thing or promise, or in any other form, under circumstances in which it could reasonably be inferred that the gift was intended to influence said employee, member or director, or could reasonably be expected to influence said employee, member or director, in the performance of the official duty of said employee, member or director or was intended as a reward for any official action on the part of said employee, member or director.

Firms responding to this RFP 2016-02 should note that the State recognizes that conflicts may occur in the future because a Firm may have existing or new relationships. The State will review the nature of any such new relationship and reserves the right to terminate the contract for cause if, in its judgment, a real or potential conflict of interest cannot be cured.

“Accepted and Agreed To”:

_____/_____/_____/_____
Signature / Name / Title / Date



Corrections and Community Supervision

ANDREW M. CUOMO
Governor

ANTHONY J. ANNUCCI
Acting Commissioner

Addendum II to RFP 2016-02, Inmate Telephone System

Amended Language and Amended Cost Proposal Form (Appendix H)

The NYS Department of Corrections and Community Supervision (DOCCS), is amending the sections of the Request for Proposals (RFP) 2016-02, *Inmate Telephone System*, as noted below. In addition, based on the changes to the language in the following sections and the *Official Responses to Questions*, DOCCS is amending the Appendix H, *Cost Proposal Form*.

Bidders must sign the acknowledgement at the end of this Addendum II to illustrate their understanding of, and agreement with, the changes represented herein and agreement to use the attached Appendix H, Amended Proposal Cost Form, to complete the requisite Cost Proposal for this RFP solicitation.

The following RFP subsections are hereby replaced by the specific language below:

3.10 INFORMATION OWNERSHIP

DOCCS shall own all inmate data and call recordings and DOCCS' information developed, stored or used in the ITS. Vendor shall provide DOCCS access to customer account records excluding private financial data.

3.12 PHASE-OUT PLAN

The vendor shall provide DOCCS with a full explanation of how it will handle a transition to a succeeding vendor at the end of the contract period. The plan must describe how the vendor will 1) provide any and all data including call recordings to the succeeding vendor or DOCCS in a manner that will allow DOCCS to access individual recordings using the succeeding vendor's system; or 2) a mechanism that will allow DOCCS to search for and access individual recordings for up to one year after the transition is complete. The plan must also describe how "Flagged" call recordings, which are retained indefinitely, will be provided and/or made accessible to DOCCS following the transition to the succeeding vendor. The plan must also describe how the proposed transition plan will maintain the chain of custody of individual recordings, whether Flagged or not, should they be needed as evidence following the transition to the new system. Any DOCCS-owned equipment located outside DOCCS' sites, such as recording equipment and software, must be provided to the next contractor or DOCCS at no cost. DOCCS shall own all premised-based equipment installed and all data.

Addendum II to RFP 2016-02, Inmate Telephone System

7.2.1 Domestic

The rate proposed and charged by the vendor shall be a single, per minute rate inclusive of all vendor fees, connect charges or other costs for all calls within the United States, its territories and protectorates, and Canada. The rate shall be the same for pre-paid and collect calls. Call rates may not exceed \$0.050.

7.2.2 International

Although DOCCS does not allow international calls currently, the vendor shall propose a rate structure for international calls detailing rates by country. The rates for international calls shall be a single per minute rate by country inclusive of all vendor fees, connect charges or other costs. DOCCS reserves the right to implement any alternative international calling services and does not guarantee minimum international calling volume. Any location not within the area defined as covered by the domestic rate as detailed above shall be treated as international. The rate for each country shall be the same rate for pre-paid and collect calls. Also, please propose a blended rate that would be applicable for all countries at a per-minute rate.

In addition, based on the changes to the RFP 2016-02 language above, please use the attached Appendix H, *Amended Cost Proposal Form*, attached to this Addendum II.

As provided in the response to Question 47 in the *Official Responses to Questions*, please note that DOCCS will not entertain bids with a vendor as a prime on one bid and a subcontractor to another bid. Additionally, each vendor may only be part of one submission.”

“Accepted and Agreed To”

_____/_____/_____/_____
Signature Name Title Date

STATE OF NEW YORK)

) SS:

County of _____)

On the ___ day of _____, 20___, before me personally appeared _____, to me known, who being by me duly sworn, _____, that he/she is the _____, of the _____, the corporation described herein which executed the foregoing instrument; and that he/she signed his/her name thereto by order of the board of directors of said corporation.

NOTARY PUBLIC

Amended Appendix H Cost Proposal Form

Prime Contractor Name: _____

Subcontractor Name(s) if applicable: _____

Authorized Signature: _____

Instructions: Complete the Amended Cost Proposal Form showing the costs for the Contract Services requested. The costs shall be considered to be inclusive of all travel, overhead, profit, and administrative expenses. The cost proposal form shall be submitted in a separate self-addressed stamped envelope in the event the Bidder is disqualified and the Cost Proposal is unopened and returned.

Vendor shall provide rates based on three decimal places (e.g. \$0.000). Rates shall apply only from the called party's acceptance of a call until the call is terminated rounded to the **nearest** whole minute (calls lasting up to and including 29 seconds over a whole minute shall be rounded down, calls greater than or equal to 30 seconds over a whole minute shall be rounded up.) There shall be no charge for the time for prompts, rate information or other functions. There shall be no additional charges or fees added to the cost of a call.

Domestic Rate: The rate proposed and charged by the vendor shall be a single, per-minute rate inclusive of all vendor fees, connect charges and/or other costs for all calls within the United States, its territories and protectorates, and Canada. **Call rates may not exceed \$0.050.**

Domestic per Minute Rate	Total Cost per Minute (including vendor fees, & surcharges)

International Rates:

The vendor shall propose a rate structure for international calls detailing rates by country. The rates for international calls shall be single, per-minute rates by country inclusive of all vendor fees, connect charges and/or other costs. DOCCS reserves the right to implement any alternative international calling services and does not guarantee minimum international calling volume. Any location not within the area defined as covered by the domestic rate as detailed above shall be treated as international.

Country	Total Cost per Minute (including vendor fees, & surcharges)

Account Holder Fees:

Itemize any fees below that may be incurred by account holders throughout the entire use and closure of the account:

Account Fees	Amount Charged Account Holders
Example: <i>Automated payment fees</i> ¹	\$3.00
Total of all fees:	

Federal and State Surcharges and Taxes:

Identify all federal and state surcharges and taxes that will be applied to the proposed rates for direct-billed and prepaid calls (**do not include amount of tax or surcharge**):

Taxes and Surcharges

¹ Automated payments include payments by interactive voice response (IVR).

Application Cover Sheet

NYS Department of Corrections and Community Supervision

RFP 2016-02, Inmate Telephone System

Return this page with the Technical Proposal as Cover Sheet.

Applicant Legal Name: Securus Technologies, Inc.

Contact Person: Robert E. Pickens

Business Address: 14651 Dallas Parkway, Ste. 600

Dallas, TX 75254-8815

Phone: (972) 277-0300 **E-Mail Address:** bpickens@securustechnologies.com

Fax: (972) 277-0514 **Website Address:** www.securustechnologies.com

Federal ID#: 75-2722144 **NYS Vendor ID#:** 1100163749

Submitted By:

Name of Authorized Official: Robert E. Pickens

Title of Authorized Official: President

Signature of Authorized Official: 

Date: January 19, 2017

Note: Signature binds applicant to a firm offer for a 120-day period from the date of the submission.

INDIVIDUAL, CORPORATION, PARTNERSHIP, OR LLC
ACKNOWLEDGMENT

STATE OF Texas)
) SS.:
COUNTY OF Dallas)

On the 19 day of January _____ in the year 2017, before me personally appeared
Robert E. Pickens, known to me to be the person who executed
the foregoing instrument, who, being duly sworn by me did depose and say that he resides at
14851 Dallas Parkway, Suite 600

Town of Dallas

County of Dallas, State of Texas

and further that: [Check One]

If an individual): he executed the foregoing instrument in his/her name and on his/her own behalf.

If a corporation): he is the President of Securus Technologies, Inc., the corporation described in said instrument; that, by authority of the Board of Directors of said corporation, he is authorized to execute the foregoing instrument on behalf of the corporation for purposes set forth therein; and that, pursuant to that authority, he executed the foregoing instrument in the name of and on behalf of said corporation as the act and deed of said corporation.

If a partnership): he is the _____ of _____, the partnership described in said instrument; that, by the terms of said partnership, he is authorized to execute the foregoing instrument on behalf of the partnership for purposes set forth therein; and that, pursuant to that authority, he executed the foregoing instrument in the name of and on behalf of said partnership as the act and deed of said partnership.

If a limited liability company): he is a duly authorized member of _____, LLC, the limited liability company described in said instrument; that he is authorized to execute the foregoing instrument on behalf of the limited liability company for purposes set forth therein; and that, pursuant to that authority, he executed the foregoing instrument in the name of and on behalf of said limited liability company as the act and deed of said limited liability company.

David M. Prichard
Notary Public
Registration No.



RETURN BOTH PAGES AS PART OF THE PROPOSAL



SECURUS
Technologies™

RFP 2016-02

INMATE TELEPHONE SYSTEM - TECHNICAL



We exist to
SERVE and
CONNECT
to make our
world safe.

An RFP Solution Prepared for:
NYS-DOCCS
Inmate Telephone System
January 23, 2017

Presented to:
Ms. Velma Berry
Contract Procurement Unit
NYS-DOCCS
550 Broadway
Menands, NY 12204

Presented by:
Adam Mercer
Advisory Account Executive
Sales-DOC
Securus Technologies, Inc.
14651 Dallas Parkway
Suite 600
Dallas, TX 75254

TABLE OF CONTENTS

APPLICATION COVER SHEET / ACKNOWLEDGEMENT	1
TABLE OF CONTENTS	1
COVER LETTER	2
EXECUTIVE SUMMARY	6
APPENDIX K - PROPOSAL RESPONSE FORMS	14
NARRATIVE RESPONSES TO REQUIREMENTS	26
2 Bidder Information	27
3 Scope of Services	32
4 Customer Service	397
5 Performance Standards	435
6 Vendor Qualifications	461
8 Contractual Issues	506
9 Administrative Procedures	525
REQUESTED DOCUMENTATION	531
COMPLETED FORMS	643
CLOSING	733
Company Summary	734
ATTACHMENTS	735
Bidder's Conference Form	737
Addendum Acknowledgements	739
Performance Bond Commitment	764

COVER LETTER

January 23, 2017

Velma Berry
NYS Department of Corrections & Community Supervision
Division of Support Operations / Contract Procurement Unit
550 Broadway
Menands, NY 12204

Dear Ms. Berry,

Securus Technologies, Inc. (hereinafter referred to as "Securus"), appreciates the opportunity to submit our response to RFP2016-02 related to Inmate Telephone System for the New York State Department of Corrections and Community Supervision (DOCCS).

The Securus Team held numerous meetings with the DOCCS ahead of this RFP release. The meetings gave Securus a better understanding of the needs and challenges faced by the DOCCS. We have listened to the DOCCS and are pleased to offer a comprehensive suite of solutions that exceeds your RFP requirements and enhances the capabilities available to your security and investigations staff – a priority for you according to your directives at the Bidders' Conference. In fact, we have listened to you and have included three distinct additions that go above and beyond your RFP requirements:

1. Securus understands the challenges that contraband, especially cell phones, present to DOCCS. To assist you in combating this issue, Securus is including 98 CellSense detection devices, manufactured by MetraSens. Cellsense is a portable, ferrous-metal detection system that detects all cell phones regardless if it is switched on or off or concealed in a body cavity. It also alerts to other ferrous metal contraband on/in inmates such as shanks, knives, razors, lighters, tattoo guns . . . etc. Cellsense conducts a full body scan in a single walk-by and can screen up to 30 people per minute. It can also be placed horizontally to quickly screen mattresses, laundry, and mail or hung up on the wall to screen staff and visitors.
2. Securus is pleased to exceed the requirement for tablets in this RFP by offering ***not 5000, but 12,000 tablets*** pre-loaded with the required content. Securus believes in the importance of education for inmates and the positive impact that it has on morale, self-worth and recidivism. That is why we are going the extra mile to help DOCCS deliver the best inmate educational programs in the country.
3. In addition, this proposal includes the provision of ***two (2) full-time tablet administrators*** to facilitate the tablet program at the direction of DOCCS. These individuals will operate within the guidelines set forth by DOCCS personnel and will assist the DOCCS Educational staff is delivering meaningful learning opportunities to the inmate population.

Since your last RFP, Securus has grown significantly, and, in fact, has invested over \$670M to expand our capabilities. This includes the acquisition of Guarded Exchange, the backbone of our Investigative Support team. We have also acquired JPay so that we can provide our clients with electronic funds transfer services, tablets and video visitation services that have been proven solutions in the DOC market for years. We acquired JLG Technologies to ensure we have the best call player and voice identification biometric capability in the industry. All of these and other investments demonstrate our commitment to our existing clients, such as DOCCS, and have put us in the leadership position in the industry. We now have the broadest solution set in the industry.

Our proposed solution far exceeds the current technology solutions provided to DOCCS by adding new security and investigative resources and capabilities, as well as the best voice biometrics system to positively identify inmates on phone calls. We will add new capabilities to assist with call monitoring and investigative staff. And, we will meet the Minority and Women owned business goals as set forth in the RFP. We will maintain 100% responsibility for your local service and support for your facilities so that we can improve your service levels and ensure that you have certified, qualified technicians available as we transition to new technologies in your facilities.

By selecting Securus for your inmate communications and investigative services requirements, you will be blazing a new trail of technology advancement and innovation for DOCCS. You will be able to easily deploy new technologies that have been developed since your last award, but have been denied to you by the limitations of your incumbent vendor. You will enable the deployment of industry leading security and investigative capabilities to enhance the productivity and efficiency of DOCCS administrators and investigators.

The Primary contact for the Securus bid will be:

Mr. Adam Mercer
Advisory Account Executive – Sales, DOC
Securus Technologies, Inc.
14651 Dallas Parkway, Suite 600
Dallas, Texas 75254-8815
amercer@securustechnologies.com
(904) 613-8477

We sincerely thank you for this opportunity to offer our proposal and look forward to participating in the next steps of the procurement process. The proposal submitted herein will remain in effect until the Comptroller has approved the award and a contract has been finalized.

Please note that I am authorized to legally bind the company.

Sincerely,



Robert E. Pickens

President

Securus Technologies, Inc.
14651 Dallas Parkway, Suite 600
Dallas, Texas 75254-8815
BPickens@securustechnologies.com

EXECUTIVE SUMMARY



Connecting What
MATTERS

Executive Summary

Thank you for allowing Securus the opportunity to provide you with the best-in-class response to your RFP for an Inmate Telephone System. When we began meeting with DOCCS staff several years ago, we made two distinct promises to you:

1. That we had done our “homework” and understood how important it was for you to “close the gap” in terms of technologies that were available in the market but couldn’t be offered to you through your current contract, and
2. That Securus was committed to delivering capabilities, solutions and services that are continually being improved upon with your input

We are proud to present our response to your RFP – a response that you will find meets and exceeds the needs of DOCCS. Your RFP presents us with the opportunity to introduce new technologies and value-added services such as our industry leading voice biometrics and new investigative support services to assist your intelligence gathering. It also provides us with the opportunity to prove to you that Securus is the best partner to immediately and significantly advance the technology capabilities that are available to DOCCS staff, AND to continue the evolution of those capabilities throughout the life of the contract. Our

proposal also includes consideration of partnerships and capabilities that could provide DOCCS with additional capabilities such as offender tablets, secure e-messaging for inmates and new kiosks that are multi-functional and able to facilitate expanded inmate self-help capabilities.

Proposal Strategy

Our strategy in developing our proposal has been to provide the absolute maximum in technology and investigative services, while also keeping DOCCS among the national leaders in terms of lowest calling rates. We have paid close attention to minimizing disruptions within your facilities and leveraging what we have learned over the course of our twenty-nine-plus year history. This experience allows us to develop new technologies and provide them as they become available.

In addition, Securus has seamlessly transitioned over 2,200 facilities from legacy competitors to our Secure Call Platform (SCP). Specifically, Securus has an excellent track record for transitioning Department of Corrections facilities from the Agencies' current inmate telephone system, including the States of Missouri, Connecticut, Louisiana and Pennsylvania. We have the most experienced team of design and installation professionals who are dedicated to making the transition to Securus seamless.

After reviewing your request for proposal, Securus is confident that our solution will completely meet or exceed all of the specifications set forth by the state agency. More specifically, our response will address the following evaluation criteria:

- **Technical Evaluation (95 points)** – The Securus Technical capabilities presented in this proposal are primarily centered on the Secure Call Platform (SCP), adding required improvements in functionality and features, and adding technical capabilities that address acute needs. We will immediately and significantly “close the gap” between the technologies and capabilities that are currently available to DOCCS and what is available in the market today. In addition, we will commit to advancing that technology throughout the contract and make those advances available to DOCCS, rather than holding them back as leverage for a new contract. We have paid specific attention to the need to “describe” all products and services throughout this document. It should be noted that Securus is prepared to demonstrate any of these capabilities as required through the evaluation process to ensure that DOCCS can effectively compare our proposed functional and technical capabilities to those of other vendors or bidders.

Here are just a few examples of the new capabilities that meet and exceed your requirements as part of our proposal:

- **Investigative Support** – Through our industry-first team of nearly 100 highly trained analysts, **we will monitor up to seven percent (7%) of all inmate calls** and provide live, real-time investigative analysis to establish links between selected inmates and called parties and to identify activities such as gang, drug, victimization, extortion and other nefarious activities.
- **Call Pattern Analysis and Alerting** with THREADS – In addition to the Investigative Support, we will utilize the only call pattern analysis and alerting solution that was designed and built exclusively for law enforcement and corrections use to identify trends within inmate calling patterns and issue an indicator when pattern changes occur.
- **Voice Recognition, Identification and Analysis** using Investigator Pro (IPRO) – Our first-in-the-industry ability to identify, not just *THAT* multiple inmate voices appear within a call, but will identify and report *THE NAMES* of all inmate voices that appear within a call – Investigator Pro will verify the inmate identity via voice identification AND continuously monitor every call to identify additional/different voices throughout the call.
- **Compare Called Parties by Voice** with Searchable Voice – This exclusive feature of *IPRO* compares called parties by voice and identifies potential matches for all inmate calls statewide. It gives investigators the ability to select a voice sample from either the inmate or called party side of an inmate's telephone call and then use that sample to search for all other calls where that voice occurs. **Tablets** –Securus has chosen to include not 5000, but 12,000 of the most widely-used inmate tablets in the entire country. These devices will come pre-loaded with DOCCS-approved and authorized content, including off-line entertainment, as well as educational and religious content and will also allow inmates to place telephone calls via the tablet from their cell, while maintaining all requirements and mandatory features of this RFP. Securus believes in the importance of education for inmates and the positive impact that it has on morale, self-worth and recidivism. That is why we are going the extra mile to help DOCCS deliver the best inmate educational programs in the country. In addition, this proposal includes the provision of two (2) full-time tablet administrators to facilitate the tablet program at the direction of DOCCS. These individuals will operate within the guidelines set forth by DOCCS personnel and will assist the DOCCS Educational staff in delivering meaningful learning opportunities to the inmate population.
- **MetraSens CellSense Cell Phone Detection** –Securus understands the challenges that contraband, especially cell phones, present to DOCCS. To assist you in combating this issue, Securus is including 98 CellSense detection devices, manufactured by MetraSens. CellSense is a portable, ferrous-metal detection

system that detects all cell phones regardless if it is switched on or off or concealed in a body cavity. It also alerts to other ferrous metal contraband on/in inmates such as shanks, knives, razors, lighters, tattoo guns . . . etc. Cellsense conducts a full body scan in a single walk-by and can screen up to 30 people per minute. It can also be placed horizontally to quickly screen mattresses, laundry, and mail or hung up on the wall to screen staff and visitors.

- **MBE/WBE Participation** – Securus recognizes the importance of partnering with organizations that have historically been underutilized or disadvantaged in the workforce, such as Minority Business Enterprise (MBE) and Women Business Enterprise (WBE). Securus is fully committed to partnering with these organizations on government contracts, and is fortunate enough to have close relationships with both PSRI Technologies (MBE) and G5 Tek Solutions (WBE). Both organizations contribute high levels of skill, experience and value to our proposal.

- **Cost Evaluation (5 points)** – Securus has proposed a competitive and balanced inmate call price in the enclosed Cost Proposal. Our price represents consideration for the need to reduce existing call pricing to reflect competitive market dynamics, but at the same time reflects a rational price that allows Securus to not only provide DOCCS with the latest in Corrections technology, but also to continue our investment in DOCCS’ needs over the course of the contract.

Why Choose Securus?

The RFP process will undoubtedly beg the question of why the New York State Department of Corrections and Community Supervision should select Securus. Securus believes that we can make the case for a DOCCS/Securus partnership by carefully considering two main questions.

1. Has Securus presented a proposal that exceeds the requirement of the current RFP?
2. Has Securus presented a proposal that exceeds the offerings of all other vendors’ proposals in the critical areas that are of the most importance to DOCCS?

Let’s analyze each of these questions separately:

Proposing Solutions That Exceed the RFP Requirements

The Securus proposal has carefully considered the specific requirements of the RFP and we have proposed technologies that meet and exceed the requirements. Not only have we included the technologies that meet your requirements; we have bundled in additional capabilities such as providing detail on the location of the called party cell phone and the ability to identify called party voices on recordings. In this way, our proposal meets every requirement in the RFP and also includes enhancements to DOCCS investigative capabilities which exceed your expectations in every way.

We enhance our service and maintenance capabilities by deploying the very best service technicians who are highly trained and certified in all aspects of our business and are qualified to perform service on the new technologies included in our proposal.

Securus Proposal versus the Competition

Unisys is *NOT* vested in the Inmate Telephone Business.

These are very tumultuous times in our industry. Companies are merging, new companies are forming and the availability of new technologies is accelerating. Securus stands alone as the only company to continually invest in the industry by purchasing companies delivering needed technology and integrating new technologies into our portfolio. We are a much stronger company today than even five years ago. That is not the case with all vendors.

All of these factors suggest that Securus is a very different company than other vendors. It suggests that we will continue to invest in this industry and deliver technologies to our clients throughout the life of the contract. It is why Securus is able to offer technologies that no other vendor can offer, technologies that may not be on the current roadmap for DOCCS, but may become important over the course of the contract period. Our purchases of JPay and JLG Technologies represent opportunities for Securus to deploy new services and technologies that are fully integrated into our current solutions.

GTL as a subcontractor is *NOT* a technology company.

Our proposal includes Investigative Support capabilities that are not available from any other vendor. While undoubtedly, other vendors will propose a “me too” solution to our investigative capabilities; no other vendor can match the value proposition associated with an Investigative Support team that has benefited by five years of developmental efforts contributed by both DOCs and Securus, has historical processes and procedures in place that those DOC entities rely on daily, and is willing to do “whatever it takes” to assist DOCCS investigators in achieving their investigative goals.

Partnerships with WBE, MBE and SDVE Organizations

Securus recognizes the importance of partnering with organizations that meet specific business criteria such as Minority Business Enterprise (MBE) and Women Business Enterprise (WBE). Securus is fully committed to opportunities to partner with these organizations, and is fortunate enough to have several of them working on the project: PSRI Technologies (MBE) and G5 Tek Solutions (WBE). These organizations contribute high levels of skill, experience and value to our proposal and meet the State's criteria for each category.

Consistent Account Management

We realize it is imperative that we meet with you frequently and that you can contact us anytime to discuss issues, concerns, or ideas. We understand your requirement for proactive, creative discussions with key departmental contacts so we can best design and develop the technologies that you most need to run your facility efficiently and safely. Advisory Account Executive, Adam Mercer, will lead the team and will draw from his past experience working with Departments of Corrections across the country.

Continued Investment

We continue to invest heavily in both our own technology and complimentary technology that help us to better serve our partners' needs. We focus on acquiring technology, not simply customer accounts. We believe that our expanded offerings, such as **Investigative Support, Voice Biometric Identification** and **Tablets** help us to solve our current partners' challenges and attract new partners. Our acquisition strategy, coupled with our continuous enhancements to our centralized SCP calling platform, has created a technology and product base that is unmatched in the inmate communications industry. More importantly, unlike your incumbent vendor, Securus does not withhold new technologies when they become available. We do not hold our partners hostage in exchange for contract extensions. When technologies become generally available to our customer base, they are generally available to DOCCS. This means the SCP system that you receive on day one will continue to grow and evolve to meet the needs of New York State.

*Our competitors provide systems ... **Securus delivers solutions!!***

Family Members and Friends Focus

Securus continues to focus on providing the industry's best service for the family members and friends of offenders. We continue to increase the number of associates serving offenders' loved ones from our multi-million dollar customer care center based in Dallas, Texas. Securus associates are available to assist family members and friends of offenders

24 hours a day, 7 days a week, and 365 day a year. Compare this to the offerings of our competitors, many of whom have significant gaps in live-person service each day.

Continued Training Opportunities Through Bi-annual Investigative Technology Workshops

Securus recognizes the importance of keeping up with changes in technology. This proposal includes transportation, lodging and food for up to five (5) DOCCS staff to attend bi-annual Investigative Technology Workshops at our state-of-the-art Technology Center, located in Dallas, Texas. These workshops will not only enhance the skills and capabilities of staff; they can function as training and certification opportunities, as well. This is in addition to the on-going training and support provided throughout the contract term.

Securus appreciates the opportunity to earn your business. As you review our proposal and evaluate the information we have provided, remember these commitments based upon your required criteria:

- A. Delivery of Services
 - a. Securus will provide DOCCS with a proven, seamless transition process
 - b. Securus will provide DOCCS with the most ongoing training opportunities

- B. Telecommunications Capabilities
 - a. Securus will provide DOCCS with the industry's best technology
 - b. Securus will provide DOCCS with innovation through continued investment

- C. Business Operations Capabilities
 - a. Securus will provide DOCCS with unsurpassed service and support
 - b. Securus will provide DOCCS with outstanding Family and Friends service

To paraphrase what we said above, the decision for DOCCS comes down to two questions:

1. Which vendor has presented a proposal that best exceeds the requirement of the current RFP?
2. Which vendor has presented a proposal that exceeds the offerings of all other vendors' proposals in the critical areas that are of the most importance to DOCCS?

When all of the pages are reviewed, points tallied, and you compare our technologies and services to other vendors, you will come to the inescapable conclusion that ***there is ONLY ONE CHOICE*** to deliver the Inmate Telephone System needs for the New York State Department of Corrections and Community Supervision ... ***The answer is Securus.***

APPENDIX K – PROPOSAL RESPONSE FORMS

Submit the completed Appendix K with the Technical Proposal.

Instructions:

1. **Read & Agree column:** Respond to each itemized section and subsection by indicating that you have read the information in the RFP and that you agree with the requirement by marking the box.
2. **Supporting Document(s) Required column:** If the section and/or subsection requires supporting documentation, a Y will appear in this column. Include the requested documents.
3. **Addressed in Proposal and/or Documents Included:** Mark the box in this column to indicate that you have addressed the section/subsection and/or have included the requested documents in your proposal.
4. **Points Awarded:** Bidders will be scored on all items for which a Y appears in this column.
5. **Complete and sign the following certification.**

The undersigned certifies that he/she

- is knowledgeable about the submitting Business Entity's business and operations;
- has read and understands all of the questions contained in the RFP and the instructions on the previous page;
- has supplied full and complete responses for every item listed on pages 2 – 7 of Appendix K *Proposal Response Form*;
- confirms, to the best of his/her knowledge, information, and belief, that the Business Entity's responses are true, accurate and complete, including all attachments; and
- understands that New York State will rely on information disclosed in this proposal when entering into a contract with the Business Entity.

Signature of Owner/Officer: 

Printed Name of Signatory: Robert F. Pickens

Title: President

Name of Business: Securus Technologies, Inc.

Address: 14651 Dallas Parkway, Ste. 600

City, State, ZIPcode: Dallas, Texas 75254-8815

Date: January 19, 2017

Section	Title	Read & Agreed	Supporting Document(s) Required	Addressed in Proposal and/or Document(s) Included	Points Awarded
Section 1					
1	INTRODUCTION				
1.1	DOCCS MISSION STATEMENT				
1.2	BACKGROUND				
1.3	OVERVIEW OF EXISTING INMATE TELEPHONE SYSTEM (ITS)				
1.4	PURPOSE				
1.5	ISSUING AGENCY				
1.6	DESIGNATED CONTACTS				
1.7	SCHEDULE OF EVENTS				
Section 2					
2	BIDDER INFORMATION				
2.1	TERM OF AGREEMENT	<input checked="" type="checkbox"/>			
2.2	COMPLETENESS OF PROPOSAL	<input checked="" type="checkbox"/>			
2.3	MODIFICATION OF BIDS	<input checked="" type="checkbox"/>			
2.4	WITHDRAWAL OF BIDS	<input checked="" type="checkbox"/>			
2.5	INCURRING COSTS	<input checked="" type="checkbox"/>			
2.6	MANDATORY PRE-BID CONFERENCE	<input checked="" type="checkbox"/>	Y ²	<input checked="" type="checkbox"/>	
2.7	PRIME CONTRACTOR RESPONSIBILITY	<input checked="" type="checkbox"/>	Y ³	<input checked="" type="checkbox"/>	
2.8	BEST VALUE	<input checked="" type="checkbox"/>			

² Appendix J Notice of Intent to Bid

³ If subcontractors are used, they must be fully disclosed in the same manner as required of the prime contractor.

Section	Title	Read & Agreed	Supporting Document(s) Required	Addressed in Proposal and/or Document(s) Included	Points Awarded
2.9	TERMS/DEFINITIONS	<input checked="" type="checkbox"/>			
2.10	NYS AND DOCCS POLICIES	<input checked="" type="checkbox"/>			
Section 3					
3	SCOPE OF SERVICES	<input checked="" type="checkbox"/>			
3.1	SYSTEMS ARCHITECTURE	<input checked="" type="checkbox"/>			
3.1.1	Proposed Deployment Model	<input checked="" type="checkbox"/>		<input checked="" type="checkbox"/>	Y
3.1.2	Scalability	<input checked="" type="checkbox"/>		<input checked="" type="checkbox"/>	Y
3.1.3	Network Services	<input checked="" type="checkbox"/>			
3.1.4	System Trunking	<input checked="" type="checkbox"/>		<input checked="" type="checkbox"/>	Y
3.1.5	Call Quality	<input checked="" type="checkbox"/>		<input checked="" type="checkbox"/>	Y
3.1.6	Continuity of Services	<input checked="" type="checkbox"/>		<input checked="" type="checkbox"/>	Y
3.1.6.1	Backup	<input checked="" type="checkbox"/>		<input checked="" type="checkbox"/>	Y
3.1.6.2	Uninterruptible Power	<input checked="" type="checkbox"/>		<input checked="" type="checkbox"/>	Y
3.1.7	Single Clock Source	<input checked="" type="checkbox"/>		<input checked="" type="checkbox"/>	Y
3.1.8	Recording and Monitoring	<input checked="" type="checkbox"/>		<input checked="" type="checkbox"/>	Y
3.1.8.1	Investigative Support	<input checked="" type="checkbox"/>		<input checked="" type="checkbox"/>	Y
3.1.8.2	Simultaneous Access	<input checked="" type="checkbox"/>		<input checked="" type="checkbox"/>	Y
3.1.8.3	Storage	<input checked="" type="checkbox"/>			
3.1.8.4	Chain of Evidence	<input checked="" type="checkbox"/>		<input checked="" type="checkbox"/>	Y
3.1.8.5	Retrieval	<input checked="" type="checkbox"/>		<input checked="" type="checkbox"/>	Y
3.1.8.6	Equipment and Network Access	<input checked="" type="checkbox"/>		<input checked="" type="checkbox"/>	Y
3.1.8.7	Access to Recordings	<input checked="" type="checkbox"/>		<input checked="" type="checkbox"/>	Y
3.1.8.8	Call Monitoring suppression	<input checked="" type="checkbox"/>		<input checked="" type="checkbox"/>	Y
3.2	SYSTEMS MANAGEMENT	<input checked="" type="checkbox"/>			
3.2.1	Fault Management	<input checked="" type="checkbox"/>		<input checked="" type="checkbox"/>	Y

Section	Title	Read & Agreed	Supporting Document(s) Required	Addressed in Proposal and/or Document(s) Included	Points Awarded
3.2.2	Configuration Management	<input checked="" type="checkbox"/>		<input checked="" type="checkbox"/>	Y
3.2.2.1	Provisioning and Active Directory	<input checked="" type="checkbox"/>		<input checked="" type="checkbox"/>	Y
3.2.3	Accounting Management	<input checked="" type="checkbox"/>		<input checked="" type="checkbox"/>	Y
3.2.3.1	Third Party Auditing	<input checked="" type="checkbox"/>			
3.2.3.2	Call Detail Records (CDR)	<input checked="" type="checkbox"/>			
3.2.4	Performance Management	<input checked="" type="checkbox"/>		<input checked="" type="checkbox"/>	Y
3.3	MANDATORY FUNCTIONS	<input checked="" type="checkbox"/>			
3.3.1	Alert Groups	<input checked="" type="checkbox"/>	Y	<input checked="" type="checkbox"/>	Y
3.3.2	Pre-recorded Names	<input checked="" type="checkbox"/>			
3.3.3	Access to Rape Crisis Programs	<input checked="" type="checkbox"/>			
3.3.4	Access to Toll-Free Assistance Lines	<input checked="" type="checkbox"/>			
3.3.5	Announcements	<input checked="" type="checkbox"/>	Y	<input checked="" type="checkbox"/>	Y
3.3.6	Automatic Number Identification	<input checked="" type="checkbox"/>		<input checked="" type="checkbox"/>	Y
3.3.7	Billing Name and Address Lookup	<input checked="" type="checkbox"/>		<input checked="" type="checkbox"/>	Y
3.3.8	Class of Restriction (COR)	<input checked="" type="checkbox"/>		<input checked="" type="checkbox"/>	Y
3.3.9	Investigative Tip Line	<input checked="" type="checkbox"/>			
3.4	MANDATORY FEATURES	<input checked="" type="checkbox"/>			
3.4.1	Harassment Blocks	<input checked="" type="checkbox"/>		<input checked="" type="checkbox"/>	Y
3.4.2	Call Termination	<input checked="" type="checkbox"/>		<input checked="" type="checkbox"/>	Y
3.4.3	Number Control	<input checked="" type="checkbox"/>			
3.4.4	Personal Allowed Numbers (PAN)	<input checked="" type="checkbox"/>			
3.4.5	Phone Scheduler	<input checked="" type="checkbox"/>			
3.4.6	Personal Identification Numbers (PIN)	<input checked="" type="checkbox"/>			
3.4.7	Administration	<input checked="" type="checkbox"/>		<input checked="" type="checkbox"/>	Y
3.4.8	Third Party Call Detection	<input checked="" type="checkbox"/>		<input checked="" type="checkbox"/>	Y

Section	Title	Read & Agreed	Supporting Document(s) Required	Addressed in Proposal and/or Document(s) Included	Points Awarded
3.4.9	Hours of Operation	<input checked="" type="checkbox"/>			
3.4.10	Call Duration	<input checked="" type="checkbox"/>			
3.4.11	Telephone Testing	<input checked="" type="checkbox"/>			
3.4.12	Languages	<input checked="" type="checkbox"/>		<input checked="" type="checkbox"/>	Y
3.4.13	ANI Verification	<input checked="" type="checkbox"/>			
3.4.14	Telecommunications/Relay Services for the Deaf	<input checked="" type="checkbox"/>		<input checked="" type="checkbox"/>	Y
3.4.15	Telephone Accommodations for the Visually Impaired	<input checked="" type="checkbox"/>		<input checked="" type="checkbox"/>	Y
3.4.16	Call Pattern Analysis and Alerting	<input checked="" type="checkbox"/>		<input checked="" type="checkbox"/>	Y
3.4.17	Voice Recognition, Identification, and Analysis	<input checked="" type="checkbox"/>		<input checked="" type="checkbox"/>	Y
3.4.18	Emergency Shut Down	<input checked="" type="checkbox"/>		<input checked="" type="checkbox"/>	Y
3.5	EQUIPMENT	<input checked="" type="checkbox"/>			
3.5.1	Telephones	<input checked="" type="checkbox"/>			
3.5.2	Portable Phones	<input checked="" type="checkbox"/>			
3.5.3	Pedestal and Enclosures	<input type="checkbox"/>			
3.5.4	Tablets	<input type="checkbox"/>			
3.5.4.1	Device Specifications	<input checked="" type="checkbox"/>	Y	<input checked="" type="checkbox"/>	Y
3.5.5	Wiring	<input checked="" type="checkbox"/>			
3.5.6	Compliance	<input checked="" type="checkbox"/>			
3.5.7	Restoration of Facilities	<input checked="" type="checkbox"/>			
3.5.8	Inventory	<input checked="" type="checkbox"/>	Y		
3.5.9	Environmental	<input checked="" type="checkbox"/>		<input checked="" type="checkbox"/>	Y
3.5.10	Servers and Processors	<input checked="" type="checkbox"/>	Y	<input checked="" type="checkbox"/>	Y
3.5.11	New Equipment	<input checked="" type="checkbox"/>	Y	<input checked="" type="checkbox"/>	Y
3.6	SOFTWARE ENHANCEMENTS AND UPGRADES	<input checked="" type="checkbox"/>	Y	<input checked="" type="checkbox"/>	Y
3.7	MAINTENANCE	<input checked="" type="checkbox"/>		<input checked="" type="checkbox"/>	Y

Section	Title	Read & Agreed	Supporting Document(s) Required	Addressed in Proposal and/or Document(s) Included	Points Awarded
3.7.1	Maintenance Responsibility	<input checked="" type="checkbox"/>			
3.7.2	Damage	<input checked="" type="checkbox"/>			
3.7.3	Maintenance Window	<input checked="" type="checkbox"/>			
3.7.4	Maintenance Center Location	<input checked="" type="checkbox"/>			
3.7.5	Maintenance Staff Experience	<input checked="" type="checkbox"/>			
3.7.6	Preventive Maintenance	<input checked="" type="checkbox"/>			
3.7.7	Remedial Maintenance	<input checked="" type="checkbox"/>			
3.7.8	Maintenance Request Reports	<input checked="" type="checkbox"/>			
3.8	TRANSITION/MIGRATION	<input checked="" type="checkbox"/>		<input checked="" type="checkbox"/>	Y
3.8.1	Project Management	<input checked="" type="checkbox"/>	Y	<input checked="" type="checkbox"/>	Y
3.8.1.1	Project Manager	<input checked="" type="checkbox"/>			
3.8.1.2	DOCCS' Resources	<input checked="" type="checkbox"/>			
3.8.1.3	Site Survey	<input checked="" type="checkbox"/>			
3.8.2	Call Recording Migration	<input checked="" type="checkbox"/>		<input checked="" type="checkbox"/>	Y
3.8.3	Fallback Plan	<input checked="" type="checkbox"/>		<input checked="" type="checkbox"/>	Y
3.8.4	Acceptance Testing	<input checked="" type="checkbox"/>			
3.8.5	Equipment Disposal	<input checked="" type="checkbox"/>			
3.9	DATA EXCHANGE	<input checked="" type="checkbox"/>			
3.9.1	National Information Exchange Model (NIEM) Standards	<input checked="" type="checkbox"/>			
3.9.2	Data Reconciliation	<input checked="" type="checkbox"/>			
3.10	INFORMATION OWNERSHIP	<input checked="" type="checkbox"/>			
3.11	SECURITY	<input checked="" type="checkbox"/>		<input checked="" type="checkbox"/>	Y
3.11.1	ITS System Security	<input checked="" type="checkbox"/>	Y	<input checked="" type="checkbox"/>	Y
3.11.2	Jurisdiction	<input checked="" type="checkbox"/>			
3.11.3	Compliance	<input checked="" type="checkbox"/>			

Section	Title	Read & Agreed	Supporting Document(s) Required	Addressed in Proposal and/or Document(s) Included	Points Awarded
3.11.4	Background Checks	<input checked="" type="checkbox"/>			
3.11.5	Information Security Breach	<input checked="" type="checkbox"/>	Y	<input checked="" type="checkbox"/>	Y
3.12	PHASE-OUT PLAN	<input checked="" type="checkbox"/>			
3.13	TRAINING	<input checked="" type="checkbox"/>	Y	<input checked="" type="checkbox"/>	Y
3.14	DOCUMENTATION	<input checked="" type="checkbox"/>			
3.15	REPORTING	<input checked="" type="checkbox"/>	Y	<input checked="" type="checkbox"/>	Y
Section 4					
4	CUSTOMER SERVICE				
4.1	SUPPORT SERVICES FOR DOCCS				
4.1.1	Principal Technical Support Representatives	<input checked="" type="checkbox"/>			
4.1.2	Toll-Free Access	<input checked="" type="checkbox"/>			
4.1.3	DOCCS Authorized Representatives	<input checked="" type="checkbox"/>			
4.1.4	Gate Clearance	<input checked="" type="checkbox"/>			
4.1.5	Ticketing System	<input checked="" type="checkbox"/>		<input checked="" type="checkbox"/>	Y
4.1.6	DOCCS' Access to Customer Information	<input checked="" type="checkbox"/>		<input checked="" type="checkbox"/>	Y
4.1.7	Court Evidence & Expert Witness Testimony	<input checked="" type="checkbox"/>			
4.2	SUPPORT SERVICES FOR CUSTOMERS	<input checked="" type="checkbox"/>		<input checked="" type="checkbox"/>	Y
4.2.1	Toll-Free Access	<input checked="" type="checkbox"/>			
4.2.2	Executive Order Number 28	<input checked="" type="checkbox"/>			
4.2.3	Customer Account Access	<input checked="" type="checkbox"/>		<input checked="" type="checkbox"/>	Y
4.2.4	Customer Outreach	<input checked="" type="checkbox"/>			
4.2.5	Call Blocking	<input checked="" type="checkbox"/>		<input checked="" type="checkbox"/>	Y
4.2.6	Vendor Account Policies	<input checked="" type="checkbox"/>			

Section	Title	Read & Agreed	Supporting Document(s) Required	Addressed in Proposal and/or Document(s) Included	Points Awarded
4.2.7	Vendor Policy Changes	<input checked="" type="checkbox"/>			
4.2.8	Aggregated Billing Account for DOCCS-Approved Organizations	<input checked="" type="checkbox"/>	Y	<input checked="" type="checkbox"/>	Y
Section 5					
5	PERFORMANCE STANDARDS				
5.1	SERVICE OBJECTIVES	<input checked="" type="checkbox"/>		<input checked="" type="checkbox"/>	Y
5.1.1	Facility Service Objectives	<input checked="" type="checkbox"/>			
5.1.2	Customer Service Objectives	<input checked="" type="checkbox"/>			
5.2	RESOLUTION OF REPORTED PROBLEMS	<input checked="" type="checkbox"/>		<input checked="" type="checkbox"/>	Y
5.2.1	Failure to Comply	<input checked="" type="checkbox"/>			
5.2.2	Escalation Requirements	<input checked="" type="checkbox"/>			
5.3	PERFORMANCE REVIEWS	<input checked="" type="checkbox"/>	<input checked="" type="checkbox"/>		
Section 6					
6	VENDOR QUALIFICATIONS				
6.1	COMPANY EXPERIENCE	<input checked="" type="checkbox"/>	Y	<input checked="" type="checkbox"/>	Y
6.2	PAST PERFORMANCE				
6.2.1	Security Incidents	<input checked="" type="checkbox"/>		<input checked="" type="checkbox"/>	Y
6.2.2	Performance Data	<input checked="" type="checkbox"/>		<input checked="" type="checkbox"/>	Y
6.2.3	Legal Validity	<input checked="" type="checkbox"/>		<input checked="" type="checkbox"/>	Y
6.3	STAFF QUALIFICATIONS	<input checked="" type="checkbox"/>		<input checked="" type="checkbox"/>	Y
6.3.1	Staffing Numbers and Qualifications	<input checked="" type="checkbox"/>		<input checked="" type="checkbox"/>	Y
6.3.2	Staff Disqualification	<input checked="" type="checkbox"/>			
6.3.3	Staff Resignation or Discharge	<input checked="" type="checkbox"/>			
6.4	VENDOR RESPONSIBILITY	<input checked="" type="checkbox"/>			

Section	Title	Read & Agreed	Supporting Document(s) Required	Addressed in Proposal and/or Document(s) Included	Points Awarded
6.4.1	Vendor Responsibility Requirements	<input checked="" type="checkbox"/>	Y ⁴	<input checked="" type="checkbox"/>	
6.4.2	Complaint History	<input checked="" type="checkbox"/>	Y	<input checked="" type="checkbox"/>	
Section 7					
7	COMPLETE THIS SECTION SEPARATELY				
Section 8					
8	CONTRACTUAL ISSUES				
8.1	APPENDIX A/ORDER OF PRECEDENCE	<input checked="" type="checkbox"/>			
8.2	ETHICS COMPLIANCE	<input checked="" type="checkbox"/>			
8.3	PROCUREMENT LOBBYING ACT	<input checked="" type="checkbox"/>			
8.4	SALES AND COMPENSATING USE TAX CERTIFICATION REQUIREMENTS	<input checked="" type="checkbox"/>			
8.5	ENCOURAGING THE USE OF NYS BUSINESS	<input checked="" type="checkbox"/>			
8.6	DIVERSITY PRACTICES	<input checked="" type="checkbox"/>	Y ⁶	<input checked="" type="checkbox"/>	Y
8.7	MWBE AND EEO REQUIREMENTS	<input checked="" type="checkbox"/>			
8.8	Use of Service-Disabled Veteran-Owned Business Enterprises in Contract Performance	<input checked="" type="checkbox"/>			
8.9	INDEMNIFICATION	<input checked="" type="checkbox"/>			
8.10	CONTRACTOR INSURANCE REQUIREMENTS	<input checked="" type="checkbox"/>			
8.11	CONSULTANT DISCLOSURE REPORTING REQUIREMENTS	<input checked="" type="checkbox"/>			
8.12	FREEDOM OF INFORMATION LAW/TRADE SECRETS	<input checked="" type="checkbox"/>			

⁴ Appendix E *Vendor Responsibility Information* (complete online questionnaire or submit the questionnaire with Technical Proposal)

⁶ Appendix M *Diversity Practices*: Complete, sign, and include requested forms.

Section	Title	Read & Agreed	Supporting Document(s) Required	Addressed in Proposal and/or Document(s) Included	Points Awarded
8.13	EXECUTIVE ORDER 26	<input checked="" type="checkbox"/>			
8.14	EXECUTIVE ORDER 38	<input checked="" type="checkbox"/>			
8.15	PERFORMANCE/PAYMENT BOND REQUIREMENT	<input checked="" type="checkbox"/>			
8.16	LICENSED OR PATENTED COMPONENTS	<input checked="" type="checkbox"/>			
8.17	PERPETUAL LICENSE	<input checked="" type="checkbox"/>			
8.18	ESCROW OF SOFTWARE	<input type="checkbox"/>			
8.19	BREACH OF SERVICES	<input checked="" type="checkbox"/>			
8.20	GENERAL REQUIREMENTS	<input checked="" type="checkbox"/>			
8.21	EQUIPMENT AND LICENSES UPON TERMINATION	<input checked="" type="checkbox"/>			
8.21.1	Agency Termination	<input checked="" type="checkbox"/>			
8.21.2	Procurement Lobbying Termination	<input checked="" type="checkbox"/>			
8.22	CONTRACT TERMS	<input type="checkbox"/>			
8.23	NONDISCLOSURE AGREEMENT	<input checked="" type="checkbox"/>			
8.24	CONTRACT PROVISIONS	<input checked="" type="checkbox"/>			
8.25	POTENTIAL ANNUAL REVENUE PAYMENTS	<input type="checkbox"/>			
8.26	INMATE SECURE MESSAGING OPTION	<input checked="" type="checkbox"/>			

Section	Title	Read & Agreed	Supporting Document(s) Required	Addressed in Proposal and/or Document(s) Included	Points Awarded
Section 9					
9	ADMINISTRATIVE PROCEDURES				
9.1	COMMUNICATION WITH DOCCS	<input checked="" type="checkbox"/>			
9.2	PROCUREMENT RIGHTS	<input checked="" type="checkbox"/>			
9.3	PROPOSAL FORMAT, PACKAGING, & SUBMISSION	<input checked="" type="checkbox"/>			
9.3.1	Proposal Content (Pass/Fail)	<input checked="" type="checkbox"/>			
9.3.2	Other Legal Documents	<input checked="" type="checkbox"/>			
9.3.3	Technical Proposal	<input checked="" type="checkbox"/>			
9.3.4	Cost Proposal	<input checked="" type="checkbox"/>			
9.3.5	Diversity Practices Questionnaire (2 Points)	<input checked="" type="checkbox"/>			
9.4	PROPOSAL EVALUATION	<input checked="" type="checkbox"/>			
9.4.1	Mandatory Requirements (Pass/Fail)	<input checked="" type="checkbox"/>			
9.4.2	Technical Evaluation (83 Points)	<input checked="" type="checkbox"/>			
9.4.3	Cost Evaluation (5 Points)	<input checked="" type="checkbox"/>			
9.4.4	Composite Scores	<input checked="" type="checkbox"/>			
9.4.5	Debriefings	<input checked="" type="checkbox"/>			

NARRATIVE RESPONSES TO REQUIREMENTS

2 Bidder Information

2.1 Term of Agreement

The Agreement shall run for five (5) years beginning October 1, 2017, through September 30, 2022, contingent on approval of the Office of the State Comptroller (OSC). DOCCS reserves the sole right to renew the Agreement for two additional one-year periods under the same terms and rates by notifying the contractor of its intention no less than one-hundred-eighty (180) days before the expiration of the original Agreement or the initial one year renewal period.

DOCCS reserves the right to seek a refresh of any or all equipment and/or software provided or maintained as a result of this RFP after the fourth year of this agreement.

DOCCS reserves the right to seek reduced rates and/or new terms of agreement from the contractor prior to any extension.

SECURUS HAS READ, AGREES AND WILL COMPLY WITH THIS REQUIREMENT.

2.2 Completeness of Proposal

Bidders must submit proposals describing the complete range of services specified in this RFP. It is the responsibility of the bidder to verify the completeness of its proposal and its suitability to meet the requirements of this RFP. Proposals that fail to meet the mandatory requirements will be disqualified.

SECURUS HAS READ, AGREES AND WILL COMPLY WITH THIS REQUIREMENT.

2.3 Modifications of Bids

Once submitted, proposals may not be modified unless DOCCS specifically requests a clarification or explanation. Any clarification or explanation submitted by a bidder shall be done so in written form only. Modifications submitted by a bidder after the formal submission date that are not in response to a written request from DOCCS shall not be accepted.

SECURUS HAS READ, AGREES AND WILL COMPLY WITH THIS REQUIREMENT.

2.4 Withdrawal of Bids

Bids cannot be withdrawn for a minimum of 120 days after the bid submission date (see State Finance law Section 163.9(e).) Written requests to withdraw proposals after the 120-day period may be granted only with written permission from DOCCS.

SECURUS HAS READ, AGREES AND WILL COMPLY WITH THIS REQUIREMENT.

2.5 Incurring Costs

DOCCS shall not be held liable for any costs incurred by the bidder in the preparation, production or submission of a proposal, or for any work performed by a bidder prior to the approval of an award Agreement.

DOCCS shall not be held liable for any costs incurred by a bidder for the bidder's requirement to attend the mandatory Bidders' conference to be held at the location specified in Section 2.6.

DOCCS shall not be held liable for any costs incurred by a bidder in modifying or explaining details of the bidder's proposal in response to questions from DOCCS.

DOCCS shall not be held liable for any costs incurred by a bidder for any negotiations with DOCCS required to finalize and sign a formal Agreement document.

SECURUS HAS READ, AGREES AND WILL COMPLY WITH THIS REQUIREMENT.

2.6 Mandatory Bidders' Conference

Bidders intending to submit a proposal shall be required to attend a mandatory bidders' conference to be held on the day indicated in Section 1.7, *Schedule of Events*, at DOCCS Training Academy, 1134 New Scotland Road, Albany, NY 12208, beginning at 1:00 p.m. ET. **Only bidders who attend the mandatory bidders' conference will be qualified to submit proposals.**

All attendees **must** be preregistered to be admitted to the mandatory bidders' conference and must present U.S. government or state issued picture identification. Bidders must preregister at least two business days prior to the conference date by completing **Appendix J** and emailing the form to the address specified in [Section 1.6](#). It is the responsibility of all bidders to ensure proper delivery of the emailed notices.

Bidders should email all questions to be considered at the Bidders' Conference to the designated contacts identified in [Section 1.6](#) no later than one (1) business day prior to the conference. A list of all questions sent in by all interested parties may be made available at the start of the mandatory bidders' conference.

Questions not submitted prior to the mandatory bidders' conference may be answered at the conference only if DOCCS believes doing so would be in the best interest of the State.

All answers provided for written questions at the mandatory bidders' conference shall be supplied to all attendees in writing by the due date for the Official Response to Bidders' Questions ([Section 1.7](#)). All responses provided at the bidders' conference will be unofficial until issued in written form. All subsequent questions must be submitted in writing by the due date in Section 1.7, *Schedule of Events*. Answers to all questions and a copy of the Bidders' Conference transcript will be posted on the NYS Contract Reporter and the DOCCS' Web site no later than the date published in Section 1.7. If there is a conflict between the Official Responses to the Questions and the transcript from the Bidders' Conference, the Official Responses will take precedence.

SECURUS HAS READ, AGREES AND WILL COMPLY WITH THIS REQUIREMENT.

See Attachment A – Bidders' Conference Form (page 735)

2.7 Prime Contractor Responsibility

Bidders may submit a proposal utilizing the services of subcontractors for any aspect of this procurement; the prime contractor must assume complete responsibility and liability for the delivery of all services. Subcontractors may be used to meet the qualifications required herein; however, subcontractors must be fully disclosed in the same manner as required of the prime contractor and must provide the same information including *Vendor Responsibility Questionnaires* company finances and staff qualifications. The roles and responsibilities of each proposed subcontractor must be clearly delineated in the bidder's response to [Section 3.1.1](#), *Proposed Deployment Model*, and bidders should inform all subcontractors that references for the related areas of service must be provided as indicated in [Section 6.1](#), *Company Experience*.

SECURUS HAS READ, AGREES AND WILL COMPLY WITH THIS REQUIREMENT.

2.8 Best Value

The contract resulting from this RFP will be awarded to the qualified bidder whose proposal is determined to provide the best value to the State as defined in NYS Finance Law § 163.

SECURUS HAS READ, AGREES AND WILL COMPLY WITH THIS REQUIREMENT.

2.9 Terms/Definitions

The terms *shall*, *must*, and *will* designate mandatory requirements. If a Bidder fails to meet **any** of these requirements they will be disqualified from further consideration.

The terms *bidder*, *vendor*, *contractor*, and *provider* are used interchangeably herein and shall have the same meaning.

The name of this agency, NYS Department of Corrections and Community Supervision, is used interchangeably herein with *Department* and *DOCCS*.

SECURUS HAS READ, AGREES AND WILL COMPLY WITH THIS REQUIREMENT.

The following is an incomplete listing of definitions for acronyms:

Acronym	Definition of Acronym
ANI	Automatic Number Identification
DIN	Department ID Number
DTMF	Dual Tone Multi-Frequency
ET	Eastern Time
FTP	File Transmission Protocol
NIEM	National Information Exchange Model
PIN	Personal Identification Number
RPO	Recovery Point Objective
RTO	Recovery Time Objective
TN	Terminating Number
WAV	Waveform Audio File Format is a Microsoft and IBM audio file format standard for storing an audio bitstream on PCs

SECURUS HAS READ, AGREES AND WILL COMPLY WITH THIS REQUIREMENT.

2.10 NYS and DOCCS Policies

The Bidder must agree to comply with all applicable New York State and DOCCS policies, procedures, regulations and directives throughout the term of the contract. Any individual hired by the Contractor to work in the facilities, by virtue of accepting his/her assignment, must abide by all the policies, rules and regulations of the Department.

Each individual staff member providing services in a correctional facility should be made aware of and agree to the following Department Directives, as currently written, or as revised:

- #2216 - Fingerprinting/Criminal History Inquiry - New Employees and Contractors
- #4936 - Search of Department Employee
- #4900 - Security in the Gate Area

The directives will be available to the selected vendor once the contract resulting from this solicitation is approved by the Office of the State Comptroller.

In addition, the Contractor will be familiar with and provide staff with information in federal and NYS Laws as well as Department Policy on the Prevention of Sexual Abuse of Inmates: <http://www.doocs.ny.gov/PREA/PREAINfo.html>

It is the responsibility of the Contractor to see that all employees are aware of the directives cited above and all other applicable rules and regulations of the Department. Copies of all relevant parts of the Department's Employee Rule Book will be made available to the Contractor.

SECURUS HAS READ, AGREES AND WILL COMPLY WITH THIS REQUIREMENT.

END OF SECTION 2: BIDDER INFORMATION

3 Scope of Services

This section provides information for the required features, functions and capabilities of the proposed services. All of the items identified in this section should be at no additional cost to DOCCS.

The bidder must describe all of the required features, functions and capabilities of the proposed services including how the features are expected to function and the expected performance levels for each feature.

New York State will not be a test site for unproven technology. For all technology proposed, your references must include at least two sites where this technology has been in service as an integrated part of the inmate phone system for at least six (6) months. An onsite or real-time demonstration of the technology must be provided prior to finalization of the scoring for this procurement.

SECURUS HAS READ, AGREES AND WILL COMPLY WITH THIS REQUIREMENT.

The SCP system is currently running version 11.2. Only Securus has the industry's most widely used, most flexible and dynamic call control platform. No other call control platform in the industry has more features and investigative tools that can be used to keep the community safe. No competitor comes close to the number of installations we manage of our Secure Call Platform.

Securus has invested \$670 million in new technology over the past four years—something no other inmate telecommunications provider can say. This investment has led to an industry-leading system design and architecture, industry-leading investigative products, and industry-leading solutions for end-users so that we can connect more calls. DOCCS will not be a test site for unproven technology as SCP is a matured state of the art platform that has been proven in real-world Correctional facilities of all sizes.

3.1 Systems Architecture

Any proposed architecture must meet the general business needs of DOCCS and will be considered and evaluated for its relative merit. Bidders may propose an architecture that is fully hosted, partially hosted, centralized, distributed, or any combination thereof.

Provide information on your proposed system architecture addressing each subsection and request under Section 3.1.

SECURUS HAS READ, AGREES AND WILL COMPLY WITH THIS REQUIREMENT.

SCP is a state-of-the-art, Web-based system designed to provide DOCCS facilities with the ultimate in inmate call control and reporting. SCP's advanced features provide tools for controlling inmate calling, reducing fraud, increasing investigative capabilities, and generating valuable administrative reports. Securus was the first company that implemented a fully hosted centralized calling platform for the corrections industry. We were able to accomplish this by custom creating a solution with the use of cutting edge Voice over IP (VoIP) protocols with a cluster of Media Servers, Recording Servers and a multitude of ancillary services. With High Availability, Failover & Disaster Recovery in mind we created a cluster architecture with multiple nodes that are geographically distributed. Each node can be removed or added to the cluster pool any time during the day without impacting the call traffic. In case of disaster or prolonged

outage in one of our Data Centers the whole cluster can be failed over to the other Data Center in a short amount of time. Our innovative approach has created a unique patented solution in the industry that no other competitors can replicate.

At Securus, we also understand that being the first doesn't mean anything unless we continue to enhance and adopt the latest technology trends to provide our customers the best solution in the industry. Securus has invested \$670 million in new technology over the past four years which has led to an industry-leading system design and architecture, industry-leading investigative products, and industry-leading solutions for end-users so that we can connect more calls.

3.1.1 Proposed Deployment Model

Describe in detail the proposed solution's deployment model.

Include in your response a detailed drawing of your recommended model in Microsoft Visio format, and

SECURUS HAS READ, AGREES AND WILL COMPLY WITH THIS REQUIREMENT.

The Securus development team custom built the centralized SCP system for the corrections industry, making this platform a fully-integrated system of simple-to-use software tools, and computer and telephony hardware. SCP is hosted in carrier class Data Centers that are geographically distributed for High Availability and Failover. All the recordings and call detail records are secured in Data Centers outside of the facility.

SCP can monitor, record, block/unblock inmate telephone calls, and generate reports in real-time. Software updates are provided three to four times per year at no cost to DOCCS.

Only Securus has the widest variety of corrections solutions that reduce operational workload, increase safety & security, and provide correctional staff and inmates unprecedented communication access. Our commitment to technology means that we'll continue to innovate and provide you with cutting-edge solutions, now and throughout the term of our agreement. This commitment allows us to meet DOCCS stated goals of connecting inmates with their families while at the same time providing staff with the best investigative and intelligence gathering tools available.

The SCP system's centralized architecture allows us to provide cutting-edge software updates at regular intervals, with no downtime. Securus provides upgrades to all of our customers three to four times annually through a proven and tested after-hours process that allows all sites to immediately realize the benefits of each upgrade, or to delay implementation of new features that DOCCS isn't ready to accept at that time. Our system delivers proven features driven by input from the most recognized corrections and law enforcement agencies in the nation, including both Suffolk County and the New York City Department of Corrections in the State of New York.

Maintenance events are always preceded by a splash screen displayed at login notifying the facility of the upcoming upgrade and new features are discussed with customers prior to implementation. These system updates are more than simple changes. They provide meaningful

features and new capabilities, which drive greater officer and community safety, staff efficiency and improved investigative response times.

System Design

SCP's hardware and software components readily adapt to the changing needs of a facility's operations. Securus stores call recordings in centralized, disaster-resistant, carrier-class data centers. All equipment used to store recordings is monitored by the Securus Network Operations Center (NOC) 24x7x365. SCP writes all recorded calls to a Network Attached Storage array (NAS) in our primary Data Center. Each NAS array is also replicated to the secondary Data Center for redundancy and failover. All recordings created on the platform reside in at least two of our Data Centers. Recordings can be downloaded from SCP in various, widely-used formats and copied to a CD, DVD or any portable media.

Within the NAS, SCP uses a software defined storage platform of very dense disk nodes from EMC. Even if three individual hard disk drives fail or one node fails, during the disk or node recovery process, the system will continue to operate without data loss.

Securus applies a high level of security to protect against cyber-attacks. Applications transmitting data across public networks support SSL, Certs, and encryption. Cisco routers, switches and firewalls are used throughout the network to protect SCP and our customers. All servers, laptops, and workstations require anti-virus and anti-spyware protection software and the latest operating system patches. Securus supports both AVG and Symantec anti-virus.

The Secure Connect Architecture (SCA) serves as the backbone of the Securus platform, which results in significantly lower operating and capital costs through its implementation. It comprises a robust data repository housing multiple data marts that each hold billions of bytes of stored information gathered from multiple sources. Securus uses Oracle Exadata platform for the data repository which is replicated between data centers using Oracle Datagaurd technology as well as backed up to tape nightly with tapes sent off site for disaster recovery. The Oracle Exadata uses multiple nodes know as storage cells with software defined data protection.

The SCA delivers an intelligent retrieval system that retrieves and processes user requests through a cross-application, cross data-mart retrieval process.

SCP increases usability by providing anywhere, anytime access for authorized & authenticated personnel. All of the investigative and administrative resources are available to approved personnel through the secure SCP user interface. Users can access SCP any time from any computer with access to the Internet. Users can also access the SCP user interface on mobile devices such as tablets and smartphones.

Securus Network Diagram

Software Development

We use a professional and formal approach to platform and process design that ensures quality software and functionality releases. Before release, all modifications to the platform undergo rigorous testing in separate functional & load test environments.

The Securus use of information technology (IT) best practices, industry standard quality measurement tools, and strict environmental controls ensure the highest system functionality and availability. The Securus development team uses a Software Development Lifecycle (SDLC) that ensures high-quality deliverables. The feature/functionality enhancements process stages are:

- Analysis
- Design
- Development
- Quality Assurance
- Implementation
- Post Implementation Support

Each phase has specific deliverables and gates (controls) to ensure high quality and to minimize rework. Securus uses the following distinct system environments in conjunction with our SDLC:

- Development – Used by Development to create and unit test new enhancements
- Quality Assurance – Used by Quality Assurance Analysts to test and certify new enhancements and bug fixes
- Pre-Production – Used by Production Support personnel to validate hot fixes for production, and for final validation and mock deployment of major functionality releases
- Production – Used by all Securus customers and accessible by only authorized Securus Production Support and Tech Support personnel

Each environment has formal access controls that protect our source code and ensures proper promotion of code from one environment to the other.

Securus uses industry-standard HP Quality Center that offers software quality assurance, including requirements management, test management and business process testing for IT and application environments. Our Quality Assurance department follows a rigorous test cycle including:

- Verification of New Functionality – Ensures a feature is working as designed
- Load Testing – Determines the upper threshold or breaking point of the component or feature
- Performance Testing – Determines the expected user experience
- Regression Testing – Ensure all existing functionality still works as designed
- Exception Testing – Tests boundary conditions and unexpected usage scenarios

New releases typically create new functionality. Upon completion of the Quality Assurance stage, the code changes are packaged and deployed into our pre-production environment for the final end-to-end quality check, and to optimize the implementation. This effort enables Securus to minimize the maintenance window related to system changes.

Both IT and business stakeholders review and must approve all scheduled changes to production in two change control meetings to safeguard the stability of the production environment.

Upon implementation of new code into production, Securus Production Support and IT Development monitor changes closely to minimize the impact of any adverse or unexpected system behavior.

This attention to detail allows Securus to build feature functionality that leads the industry in quality and performance. For example, the Securus three-way call detection feature has been proven to be more accurate than the same feature offered by competitors. Independent testing by an outside research and testing company proves it. Similarly, our voice biometric features lead the industry in accuracy. This is a critical distinction, as DOCCS have stated an intent to obtain the highest quality and most reliable investigative and intelligence gathering tools available in the market today.

The voice quality available on our call platform provides near perfect fidelity. Customers have used information heard through background conversations to prevent and solve crimes.

Our quality control does not end with our system design but continues all the way through site installation. Securus and each customer develop a defined quality checklist to install the system in a manner that meets their unique operating requirements. As described and included with our installation plan, Securus uses quality control checkpoints at each phase of an installation:

- Quality Control Checkpoint 1 – Provisioning: After customer provisioning is complete, Securus technicians submit a quality control review to the Engineer, Project Manager, and Account Manager for the project.
- Quality Control Checkpoint 2 – Pre-Installation: While on-site, Securus Field Service Technicians complete a checklist to ensure that the physical installation characteristics meet or exceed Securus standards.
- Quality Control Checkpoint 3 – Equipment Testing/Functional Validation: Technicians complete test call scenarios and phone labels, call durations, on/off times, administrative terminals, and verify other customer configurations.
- Quality Control Checkpoint 4 – Acceptance: The Securus Project Team provides copies of all quality control documents, equipment inventory records, and network diagrams. The Securus Project Team will host a review of these documents with DOCCS.

Please refer to Exhibit M for Sample Quality Control Checklists. These tools are used to verify that work is completed properly before moving to the next step in a process. Securus will not consider the implementation project a complete success until all phases of DOCCS Acceptance Test phase have been completed and the project has been signed off on by appropriate DOCCS staff.

Securus Dedicated Integration Team

Securus has a dedicated Integration Department that integrates various systems and products in the corrections environment. This dedicated Integration Department allows Securus to deliver fast and flexible solutions for our customers. The Securus technology has the flexibility to work with facility-owned systems, JMS, OMS, Commissary, Banking, and Kiosk vendors. Securus will fully cooperate with your facility and your vendors to automate systems.

Securus currently integrates with more than 110 different vendors worldwide and more than 60 independent, facility-owned systems and shared databases.

- Illustrate how the proposed system will provide 99.9% yearly availability.

SECURUS HAS READ, AGREES AND WILL COMPLY WITH THIS REQUIREMENT.

Securus maintains a presence in three data centers in three geographically diverse locations.

Our data centers are designed to withstand worst case events and maintain 99.99% availability with multi-layer physical security and power delivery. The data centers, managed and staffed by a carrier-class data center host, meet or exceed the Telecommunications Industry Association's (TIA) standard number 942 for Tier IV (highest availability) data centers including:

- Ability to withstand a 96-hour power event
- 2-hour fire protection

<p>Tier 1 – Basic Small Business</p> <ul style="list-style-type: none"> • 99.671% availability • Susceptible to disruptions • Single path for power • No redundant components 	<p>Tier 2 – Redundant Medium Business</p> <ul style="list-style-type: none"> • 99.741% availability • Less susceptible to disruptions • Single path for power • Redundant components
<p>Tier 3 Large Business</p> <ul style="list-style-type: none"> • 99.982% Availability • Planned activity without disruption • Multiple paths for power • Redundant components 	<p>Tier 4 Multi-Million \$ Business</p> <ul style="list-style-type: none"> • 99.95% Availability • Can withstand at least one worst-case event • Multiple paths for power • Redundant components

TIA-942 Infrastructure standards for data centers
Telecommunications Industry Association

We keep a copy of the Call Detail Records (CDRs) in 3 different types of database systems and are physically stored in 3 different locations (Empire Central-Dallas, Texas; Atlanta, Georgia; and a Tape Depository in Dallas, Texas).

Securus facilitates anywhere, anytime, immediate access to stored recordings online for the contractually-required length of time. Securus stores call recordings in centralized, disaster-resistant, carrier-class data centers. All equipment used to store recordings is monitored by the Securus Network Operations Center (NOC) 24 hours a day, seven days a week, and 365 days a year.

The Securus SCP provides a unique set of features and advanced technologies to store call recordings. Traditional premises-based calling platforms use local hard drives that may fail and are susceptible to local disasters. Premises-based systems needed manual backup schemes that are no longer necessary with SCP. SCP writes all recorded calls to a Network Attached Storage array (NAS) in our primary Data Center. Each NAS array is also replicated to the secondary Data Center for redundancy and failover. All recordings created on the platform reside in at least two of our Data Centers. Recordings can be downloaded from SCP in various, widely-used formats and copied to a CD, DVD or any portable media.

The NAS architecture makes all storage available to all servers on the network. The NAS solution delivers complete scalability for a facility's storage requirements and supports data migration from one storage device to another and the sharing of data among different servers in a network. The NAS devices provided by EMC can scale simply by adding another node of dense SATA disk to the storage array.

Within the NAS, SCP uses a software defined storage platform of very dense disk nodes. Even if three individual hard disk drives fail or one node fails, during the disk or node recovery process, the system will continue to operate without data loss.

The Securus NAS has more than two (2) petabytes of storage space in each carrier-class data center and is continuously monitored and managed through automated processes and storage policies. When these very large storage systems approach designated thresholds, Securus expands capacity to ensure all authorized call records and recordings are retained in secure, disaster-resistant locations.

The Securus data center storage solutions provide facilities with technology that is:

- **Scalable** to meet any facility's contractually required storage demands
- **Resistant** to local disasters through multiple copies stored within the data centers and off-site
- **Highly available** through the unique architecture and design of the data storage model
- **Partitioned** and **compressed** to run queries faster
- **Secure, protected, and monitored** to enable total recall of authorized data

SCP records and stores basic call data with the capability to provide management reports. Securus does not limit the call data storage time. Since every site's requirements are different, Securus works with each facility customer to define their optimal data storage timeframe. All recordings are stored online within both carrier-class data centers. Typically, call detail records are stored for seven years.

Our competitors often misrepresent system uptime facts with regards to Securus. They will point to a single, catastrophic weather event that affected the Securus data center in Dallas, Texas. What these "negative" narratives always conveniently leave out is the extraordinary efforts of every level of our organization to transition traffic to our other data centers, minimize the impact to our customers and continue to maintain a 99.9+% system uptime - all while talented and highly trained staff guaranteed zero loss of data and minimal effect on customer productivity. In fact, most customers experienced only minor, intermittent capability outage, if any at all, while there was absolutely zero data loss across the entire Securus customer base.

- **Describe the reliability of your offerings and indicate how your solution will provide 99.9% availability.**

SECURUS HAS READ, AGREES AND WILL COMPLY WITH THIS REQUIREMENT.

Securus has designed and implemented a robust network architecture that provides for quick disaster recovery, minimizing downtime for the Securus platform and its customers. Securus has demonstrated its ability to recover efficiently under extreme circumstances, restoring service to our customers with no data loss.

Securus Business Continuity Overview

Risk Mitigation

Securus has implemented a platform and infrastructure designed to minimize potential outages and protect customer data. Multiple data centers, diverse network paths, redundant platform systems, and proactive monitoring mitigate the majority of risks.

Data Centers

Securus maintains a presence in three data centers in three geographically diverse locations. Our data centers are designed to withstand worst-case events and maintain 99.99% availability. The data centers, managed and staffed by a carrier-class data center host, meet or exceed the Telecommunications Industry Association's (TIA) standard number 942 for Tier 4 (highest availability) data centers including:

- Ability to withstand a 96-hour power event
- Two-hour fire protection
- Multi-layer physical security
- Multiple power delivery paths.

Tier 1 – Basic Small Business <ul style="list-style-type: none">• 99.671% availability• Susceptible to disruptions• Single path for power• No redundant components	Tier 2 – Redundant Medium Business <ul style="list-style-type: none">• 99.741% availability• Less susceptible to disruptions• Single path for power• Redundant components
Tier 3 Large Business <ul style="list-style-type: none">• 99.982% Availability• Planned activity without disruption• Multiple paths for power• Redundant components	Tier 4 Multi-Million \$ Business <ul style="list-style-type: none">• 99.95% Availability• Can withstand at least one worst-case event• Multiple paths for power• Redundant components

TIA-942 Infrastructure standards for data centers
Telecommunications Industry Association

Also, Securus data centers have redundant uninterrupted power systems, N+1 generator redundancy, and N+1 cooling redundancy. All systems and network equipment have redundant power paths. Multiple telecommunications carriers also serve each data center for load balancing and path diversity. Securus data centers are staffed 24x7x365 for immediate physical assistance inside the data center.

Multiple checks ensure data center physical security, including guarded, photo-verified check-in; dual-door authentication (card and biometric); and a mantrap (interlocking door controller) at the data center suite entrance.

Redundancy

Redundancy is a key component of the Secure Call Platform (SCP). While operating on a single platform, Securus' SCP runs on duplicate environments in separate data centers in Atlanta, Georgia, and Dallas, Texas. Each component has N+1 redundancy, meaning that a failure of any one component does not result in downtime because there is a backup available to resume its function. In addition to the inherent redundancy of SCP, Securus has also designed redundancy into all support systems, either through N+ 1 configuration, database clusters, virtual machines, load balancing, or other failover methods. All network transport has redundant network equipment and routing to allow traffic to reroute in the event of a failure.

The SCP platforms in Dallas and Atlanta were designed and built to the same specifications. This standardization allows re-homing of systems from their primary data center to an alternate data center in the event of a failure.

All circuits coming into Securus data centers use multiple diverse carriers, including the interconnections between data centers. In the event of a failure, traffic will reroute across a redundant circuit or path. In addition, Securus uses multiple carriers for inmate calls from the SCP platform. Calls to family and friends will immediately reroute upon failure of any carrier.

Securus uses multiple methods of storage to minimize the risk of data loss. All critical systems and data are backed up at regularly scheduled intervals and stored offsite for retrieval, if needed. In addition to offsite storage, Securus replicates voice clips, call recordings, and validation data between the data centers.

Securus uses industry-leading vendors for all platform and network hardware, including Dell, Cisco, Oracle, EMC, F5, and Intel. In addition to the redundancy designed into the platform and network, Securus also maintains a spare parts inventory onsite at each of our data centers to expedite repair of a failed component. Securus also maintains premium-level support contracts with each vendor that defines stringent service level agreements in case of a failure.

Securus maintains an inventory of spare parts for our facility-based components at our headquarters in Dallas, Texas, and has distribution agreements with multiple vendors to provide expedited national delivery service. The corporate headquarters maintains a standardized emergency recovery package of frequently used spare parts and equipment that will be available for shipment to support restoration efforts at our customer sites. Our technical field representatives located throughout the country also carry an inventory of the most commonly needed spare parts. With spare parts on board our service vehicles, most facility-based equipment malfunctions can be resolved with a single site visit.

Our competitors often misrepresent system uptime facts with regards to Securus. They will point to a single, catastrophic weather event that affected the Securus data center in Dallas, Texas. What these “negative” narratives always conveniently leave out is the extraordinary efforts of every level of our organization to transition traffic to our other data centers, minimize the impact to our customers and continue to maintain a 99.9+% system uptime - all while talented and highly trained staff guaranteed zero loss of data and minimal effect on customer productivity. In fact, most customers experienced only minor, intermittent capability outage, if any at all, while there was absolutely zero data loss across the entire Securus customer base.

Proactive Monitoring

Data Centers and Network

Securus continuously monitors all data centers, infrastructure components, platform systems, and inmate telephone systems (ITS) using the SolarWinds® suite of network performance monitors. The SolarWinds performance monitors are highly configurable to provide real-time monitoring, event notification, alert history, and statistical information. An alarm condition creates immediate visual alerts and email notifications.

The Securus Network Operations Center (NOC) provides 24x7x365 monitoring for all Securus systems, including SCP, network, back-office systems, and data centers. The NOC proactively monitors these systems to ensure performance is optimal and uninterrupted. In addition to system- and network-level monitoring, the NOC also monitors real-time video surveillance and environmental alerts for our data centers. Securus maintains a fully redundant backup NOC at a separate physical location, should services be disrupted at the primary location.

The dashboard displays several key performance indicators and system health metrics:

- Average CPU Load & Memory Utilization:** Two gauges showing Avg CPU Load at 2% and Memory Used at 66%.
- Average Response Time & Packet Loss:** Two gauges showing Avg Resp Time at 1 ms and Packet Loss at 0%.
- Disk Volumes:** A table showing disk usage for C:\Users\Software2, Physical Memory, and Virtual Memory.
- CPU Load & Memory Statistics:** Summary of current average CPU load (0%), memory used (1.871 GB, 21%), memory available (6.715 GB, 79%), and total memory (8.589 GB).
- Node Availability Statistics:** A table showing 100% availability for Today, Yesterday, Last 7 Days, Last 30 Days, This Month, and Last Month.
- Active Alerts (0):** A table showing no active alerts.
- Traffic & Percent Utilization of Each Interface:** A table showing interface status, name, receive, and transmit rates.
- Network Latency and Packet Loss - Now:** A bar chart showing response time and packet loss for testhost02 from July 21 to 29, 2015.
- Processes and Services:** A table listing various services and their CPU load, physical/virtual memory usage, and IOPS.
- Components:** A table listing system components and their response times.
- Application Health Overview:** A summary showing 51 applications are Up, with 0 Warning, 0 Critical, 0 Down, 0 Unknown, and 0 Other.

SolarWinds® Typical Monitored System and Application Elements



Securus Primary Network Operations Center



Securus Backup Network Operations Center

Premise Equipment

The Securus Technical Support teams provide 24x7x365 monitoring of all facility-based equipment and directly supports facility installations via telephone and email. Technical Support monitors connectivity for all installations and all installed equipment including integrated access devices (IADs), visitation phone monitoring (VPM) units, switches, and uninterrupted power supply (UPS) systems. The systems are polled every two minutes and their vital operating statistics sent every 10 minutes. Upon receiving an alert indicating network failure, Securus will open a trouble ticket with the appropriate circuit provider. In the case of a premise-based equipment failure, a Securus Field Technician is dispatched to the facility for on-site repair.

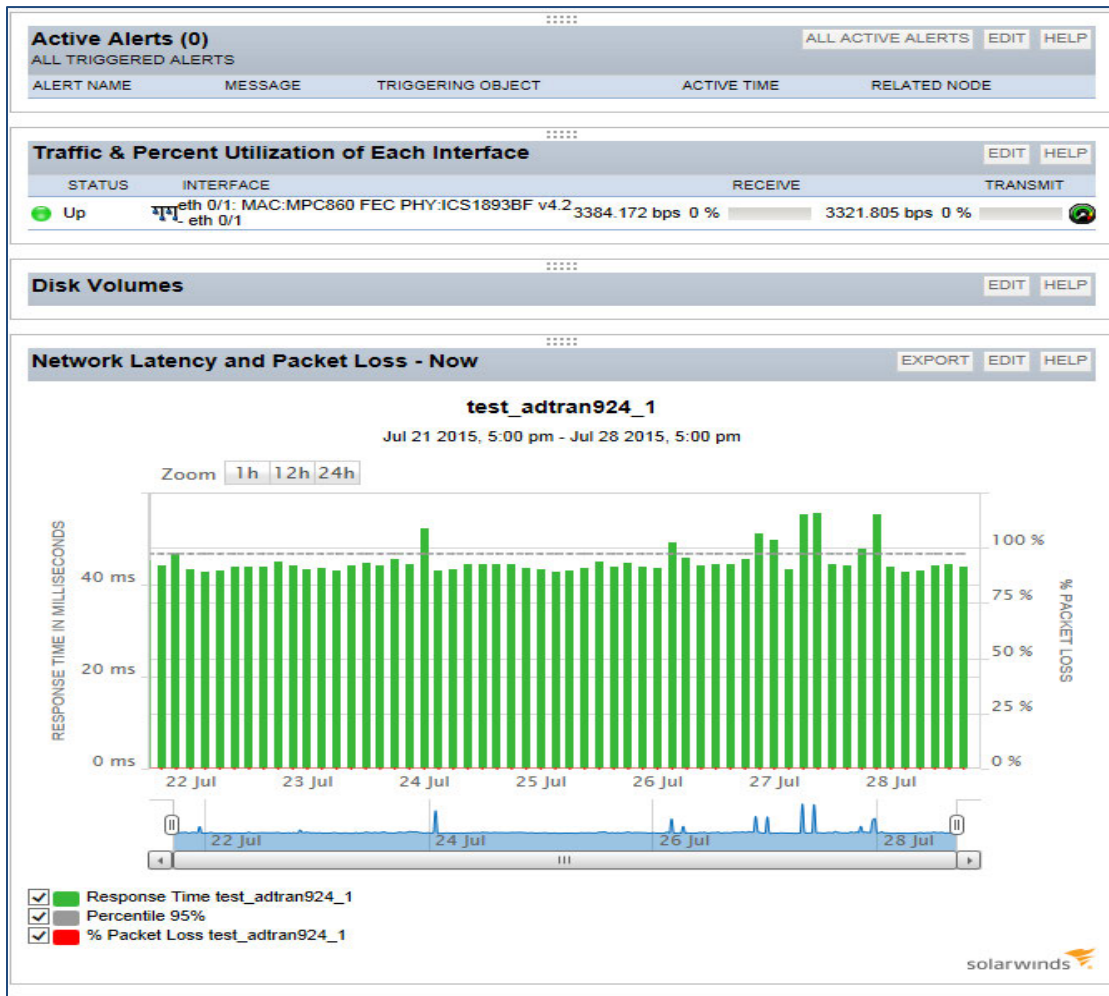

SolarWinds® Device Monitoring Example (Bandwidth & Network Latency)

In addition to real-time monitoring and alerting, Securus technical support also leverages the SolarWinds network performance monitor to gather and evaluate historical data for network alerts, bandwidth usage, packet loss, and hardware performance. The detailed level of monitoring available via our network performance monitor allows the technical support group to take proactive steps to prevent or mitigate facility outages and to ensure the correct resources are engaged if dispatch is necessary.

Restoration

Platform and Network

In the event of a disaster impacting SCP or our network, Securus immediately assembles a team of engineers to begin investigation and restoration of services. Securus maintains a schedule of on-call personnel for immediate response to service-impacting events and will also engage third party vendors, if required. If a state of emergency is declared, the Securus Business Continuity Plan will be activated.

Facility-Installed Systems

Securus prioritizes recovery of premise-based equipment by facility type and equipment location. Maximum-security institutions and institutions with high inmate phone usage receive priority. Prioritization also considers customer requirements and preferences. Securus has developed procedures and checklists to protect personnel and equipment in the event of an emergency situation. Securus will combine headquarters and field staff efforts to expedite service recovery wherever possible. Securus coordinates each checklist to ensure compliance with each facility's guidelines. DOCCS will absolutely be at the top of this priority list and our internal and field service organizations will be well-versed in the specific processes and procedures related to DOCCS account and facilities.

Securus has a field support Department with more than 165 field service associates supported by a centralized field dispatch team. The Field Service Technicians (FST) are strategically located to support ongoing maintenance, as well as any disaster recovery situations. The FSTs are supported by senior technical support resources and engineering to expedite repairs and minimize customer downtime.

Reporting

Upon confirmation of a service-impacting event, the NOC will issue an internal service interruption report (SIR). The SIR will include the nature of the outage, impact to facilities, and estimated time of restoration, if known. Each incident is assigned an urgency level based on the level of customer impact.

Customer contact personnel receive SIRs, so they can communicate with customer facilities proactively or reactively as required by the facility. In addition, technical support may communicate a service-impacting event via a splash screen on the SCP user interface introductory page, whenever possible. Regular updates ensure that the information provided is always current. Securus executives also receive all SIRs, so they are aware of all customer-impacting events.

The NOC will issue a final SIR upon issue resolution. Securus investigates each incident and completes a root-cause analysis (RCA) following all service-impacting events. After the root cause is determined, Securus makes RCA documents available to customers upon request.

Performance

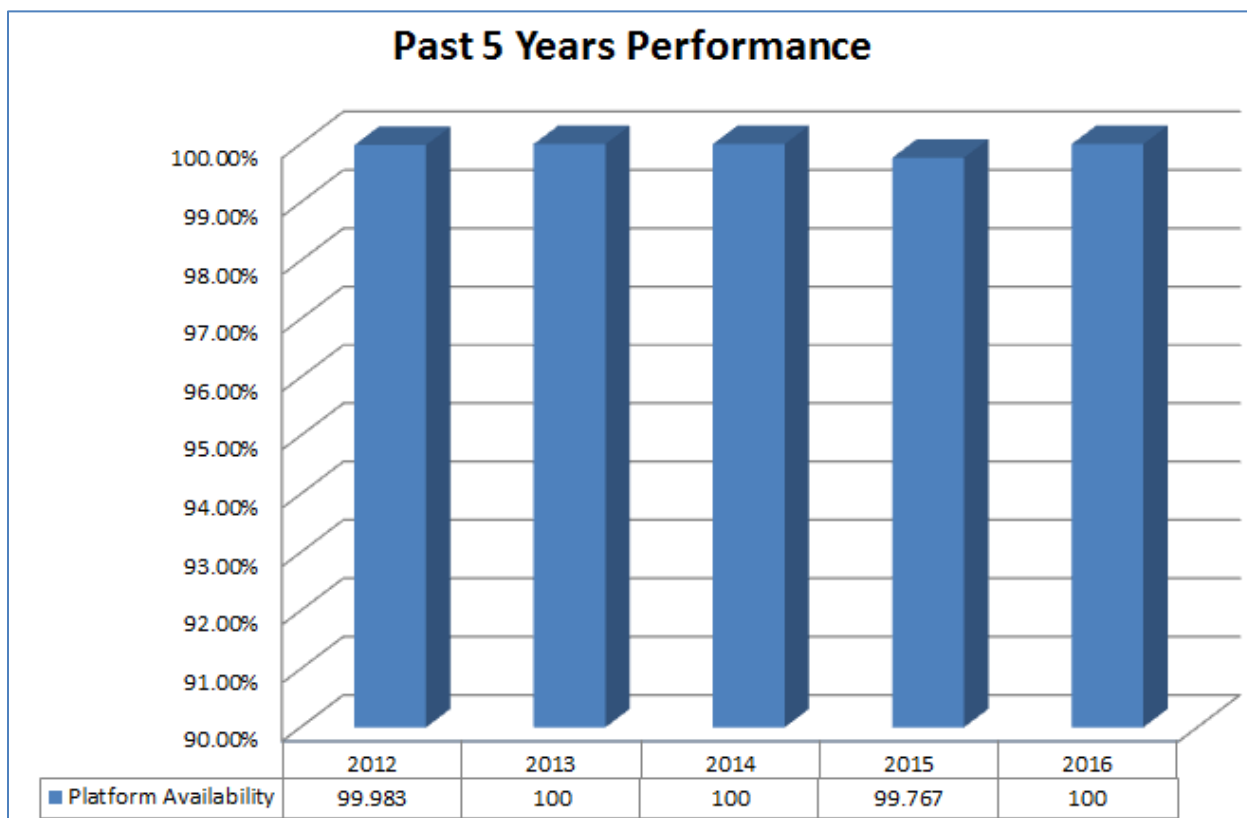

The SCP is one the most stable calling platforms in the industry, with nearly perfect, 100% availability. Through design, proactive monitoring, and rapid-response procedures, Securus minimizes customer-impacting outages. Data storage with multiple layers of redundancy minimizes the risk of losing critical data and recordings.

When disasters strike, Securus responds quickly and methodically to ensure the fastest restoration of service possible. And we have been tested.

In the spring of 2015, the Dallas, Texas, area, home to two Securus data centers, was impacted by weeks of significant storms, resulting in 27 deaths and more than one billion dollars of property damage due to flooding. Early one morning, lightning struck a Securus data center, damaging cooling units. Normally, this cooling would have been restored within minutes, but the roads leading to the data center were closed due to flooding, which caused a longer response time for service technicians. Securus' equipment rapidly overheated and began to fail. More than a quarter million dollars of components suffered fatal damage and needed replacement. Even with this once-in-a-lifetime series of compounding events, **calling services were restored the same day** for most facilities, and **there was no loss of customer data, investigative data, or recordings.**

- **Indicate any single points of failure within your solution.**

SECURUS HAS READ, AGREES AND WILL COMPLY WITH THIS REQUIREMENT.

The implementation of a centralized system significantly reduces the number of single points of failure. However, each individual DOCCS facility has a single local loop (network circuit) that if damaged by unauthorized digging could isolate the facility. This only occurs on a rare occasion when construction is taking place and is limited by rules surrounding where you can dig. Additionally, Securus has put in place one of the most sophisticated network and device monitoring systems available today. There are no problems that you will know about before we do, which allows us to troubleshoot, react and repair these items with a speed that no other vendor can match.

Securus has invested millions of dollars and thousands of hours to develop a state-of-the-art centralized system. The Secure Call Platform is engineered for “four nines” 99.99% availability. The fail safes built into the SCP effectively prevent loss of data and system downtime because all of the data is stored in a centralized database and backed up offsite. Because the system is web-based, the data can be accessed at any location with an internet connection, and Securus’ Secure Connect Architecture maintains the system at the highest level of operability.

Potential system and network abnormalities are identified through Solarwinds Orion, a centralized suite of diagnostic applications. Orion continuously monitors the hardware, software, and system performance from our Network Operations Center in Dallas. This allows personnel to diagnose and resolve issues on the system, often before an event affects DOCCS.

The infrastructure supporting the SCP was built from conception with high availability and redundancy as part of the vision. Each router, switch, server, Storage Area Network (SAN), Network Attached Storage (NAS), power, circuit, and other devices within the infrastructure is fault-tolerant (down to the component level). As an example, our routers and servers have dual Central Processing Unit (CPU), Network Interface Card (NIC), power supplies, and A & B power feeds. The telecommunications circuits into the data centers are also redundant and diverse.

Our Network Operations Center (NOC) monitors all calling traffic and patterns to establish the necessary bandwidth and network availability, which is steadily increased as the number of calls throughout the system increases or as new facilities come online.

- **Describe any vendor partnerships required to make the system fully functional and the system component(s) each party is responsible for operating and maintaining.**

SECURUS HAS READ, AGREES AND WILL COMPLY WITH THIS REQUIREMENT.

Securus does not plan to utilize any system components that will require the use of any vendor partnership to make the system fully functional.

- **Indicate why your proposed deployment model is superior over other architectures.**

SECURUS HAS READ, AGREES AND WILL COMPLY WITH THIS REQUIREMENT.

Both Unisys and Centurylink are completely disjointed from the platform that is providing service to DOCCS. Securus is the only vendor in this bid that owns and operates its own network.

Securus has the broadest set of capabilities in regards to administrative and investigative features in the inmate communications industry. This product set is part of the most widely used inmate telephone

system in the United States. We own and operate 100% of the proposed system, unlike those vendors who are prime contractors but have to subcontract out the equipment, feature and service of their proposed systems. While other vendors will propose what they refer to as a centralized system, no other vendor can offer the network size and scope, the sophistication of the monitoring system, the number of “boots on the ground” qualified service technicians and the expansive user base that Securus’ SCP inmate telephone system can.

More facilities + more inmates + more users + more features + the most, and best, service = the best system for DOCCS and the State of New York.

Securus Correctional Billing Services

Securus is unique among its national competitors in offering an in-sourced, US-based call center to provide customer service to friends and family members of inmates. Our 200+ seat call center employs customer service representatives who are Securus employees, trained and managed to Securus’ standards.

Live agent support is available to friends and family members seven days a week, 24 hours a day, and 365 days a year.

Customers can use our toll-free number (1-800-844-6591) to either speak to a live agent or use an intuitive, automated interactive voice response system to help them with their needs. For added convenience, we also offer personal account access via our website (www.securustechnologies.com). End-users can also now access Securus customer service via online “chat” 24 hours a day, seven days a week.

Our friendly and knowledgeable agents can help customers with:

- Setting up and funding accounts
- Making payment arrangements
- Obtaining information on credit limits
- Resolving complaints
- Blocking and unblocking numbers

- Reviewing call durations and history
- Learning about MoneyGram® options
- Learning about Western Union® options
- Receiving information on new services
- Confirming originating facility
- Reviewing account balances
- Answering questions and helping customers with refund requests
- Managing account notifications

Our customer service agents are highly trained on ITS issues and in satisfying the specific needs of called parties. We offer both English speaking and Spanish speaking agents.

We diligently survey our customers and measure satisfaction ratings to find ways to improve our service levels. Our customer satisfaction scores for our call center are 20 percent higher than the industry standard.

Securus offers direct billing as an option to our end user customers. The three main forms of billing including direct bill are:

- A Local Exchange Carrier (LEC)-billed account bills collect calls from the facility to the local phone company. Charges appear on the called party's monthly phone bill
- A Direct-billed account allows collect calls to be billed monthly from Securus Correctional Billing Services. The called party creating the account will be subject to a credit check (as allowed by state regulations) to create a Direct Billed account
- An AdvanceConnect/Prepaid account allows the inmate's friend or family to fund an account in advance and manage how much money they would like to spend on collect calls. If the inmate's friend or family member wishes to receive more calls, he or she may simply add more funds.

Securus offers friends and family members of inmates a wide variety of options to set up and fund prepaid accounts. Convenience drives account creation, and account creation drives more calling, so Securus has made the funding process is easy. To create and fund a pre-paid calling account, friends and family members can:

- Call our Customer Service center and speak with a live operator
- Use our automated interactive voice response system
- Use our mobile-friendly website
- Fund accounts by mail
- Visit one of more than 35,000 MoneyGram locations such as Walmart and CVS Pharmacy
- Visit one of more than 58,000 Western Union locations.

3.1.2 Scalability

The contractor must be able to accommodate an increase in services during the term of the contract as directed by DOCCS at no increase in cost and continue to meet all service and performance requirements. The system must be able to incrementally increase to support a 50% increase in volume and/or end-user devices.

Describe how your solution will meet this requirement and what actions would be needed to fulfill the demand.

SECURUS HAS READ, AGREES AND WILL COMPLY WITH THIS REQUIREMENT.

The SCP platform has been specifically designed with the capability to scale to larger call volumes easily. The system has access to multiple carriers and is designed in a modular manner. Securus' Capacity Management team continuously monitors each component of the platform for defined capacity thresholds. The capacity team has created statistical models based on seasonality and calling patterns that helps us in forecasting the growing needs proactively so capacity is never overrun in the Data Center.

For user devices (phones) Securus will install the necessary equipment in the field and engineer the circuits to support the current devices with at least the required bandwidth for all phones in use at the same time. Because of its system architecture co-located in a carrier central office, Securus has the ability to easily add inmate telephone stations, or end-user capacity, up to and beyond a 50% increase in volume and/or end-user devices or to accommodate new capacity without the need to interrupt existing, ongoing operations. All of this can be provided as directed by, and at no cost to, DOCCS.

3.1.3 Network Services

Unless otherwise agreed to by DOCCS, the contractor shall replace all circuits required to provide connectivity from each location to the contractor's proposed services. Unless otherwise agreed to by DOCCS, no proposed solution shall utilize existing or future DOCCS' telecommunication services installed at DOCCS locations. The contractor must be the customer of record for all telecommunication services used to support the proposed solution.

SECURUS HAS READ, AGREES AND WILL COMPLY WITH THIS REQUIREMENT.

Securus provides all telecommunications services used to support its inmate communications, and is the customer of record on those services.

3.1.4 System Trunking

The system must be engineered to ensure that all outbound calls are totally non-blocked. The solution proposed must reserve separate bandwidth or channels for each phone without impacting the required bandwidth for the operational characteristics of the system.

Describe how your solution will meet this requirement; detail the trunking requirements and the formula that will be used to fulfill the requirement.

SECURUS HAS READ, AGREES AND WILL COMPLY WITH THIS REQUIREMENT.

Securus' Secure Call Platform (SCP) is a centralized call management system that has been installed in more than 2,700 correctional facilities. The system is designed in such a way that additional capacity is easy to add. We engineer our network utilizing a formula of: **Number of phones installed x (bandwidth required by G729/G711 VOIP protocol + IPSEC overhead)** to maintain the capacity required to prevent non-blocking of outbound calls or busy signals.

The central processing system is designed to be scalable for more capacity and is monitored 24x7. When capacity of concurrent telephone calls reaches a threshold (not at the limit), additional capacity is added. Since the central processing system capacity is managed to keep ahead of call growth, the maximum number of inmate phones is limited only by the connectivity delivered to the facility which is infinitely scalable by adding additional circuit bandwidth to the site and at the central data center when necessary.

Both the central platform and the individual site bandwidth are designed such that calls are not blocked due to capacity constraints.

The central processing system and its network capacity can scale to many times their current capacity within the current architecture and design.

3.1.5 Call Quality

The contractor shall be required to provide telephone reception quality at least equal to current reception quality levels and shall accept DOCCS' decision regarding such determination. If an IP based solution is proposed, the bidder must detail which codec will be utilized and substantiate a Mean Opinion Score (MOS) of no less than 3.9 for the chosen codec.

Describe how your solution will meet or exceed these requirements.

SECURUS HAS READ, AGREES AND WILL COMPLY WITH THIS REQUIREMENT.

Securus is pleased to offer industry-leading digital service. Digital signaling provides vastly superior call quality than the analog signaling used by traditional premised-based telephone systems. With premised-based systems, it can be difficult to hear one or both sides of the conversation, detect and prevent three-way calling, detect call forwarding, or hear background conversations. The Securus centralized Secure Call Platform (SCP) uses private circuits and digital signaling to provide unsurpassed call clarity resulting in a higher accuracy of fraud detection and prevention, voice identification biometrics, and near-perfect sound quality.

Secure Call Platform Voice Quality

According to the Kentucky Department of Corrections: “The clarity of the call is so clear we were able to hear what was going on in the background at the called party’s house, which was a domestic dispute. We quickly sent an officer to respond.”

Differences between digital and analog call quality are distinct, as are the methods used to compare their quality:

- In the old analog environment, the sound quality is measured by loss, noise, balance and grade of service metrics. Signal loss of each trunk is measured using a 1000 cycle tone (milliwatt) which identifies the total circuit loss that is usually in proportion to circuit length (mileage) and quality of the circuit itself (analog circuits using copper can be very old and may not perform well in wet environments).
- With digital signaling (used by Securus in our packet-based network), the sound quality is measured based on Mean Opinion Score (MOS). MOS is a subjective measurement derived by averaging ratings given by independent auditors to determine an overall score. Scores range from 1 (bad) to 5 (excellent). The standard for digital telephone quality is considered a score of 3.7 or better. Even though digital signaling allows for better detection of security threats, conversations can still be impaired if there is significant (i.e. greater than 100 milliseconds) packet loss or delays. This can happen if signaling uses the public Internet or a private system that does not have the necessary bandwidth to support the voice traffic.

Our SCP uses private Multi-Protocol Label Switching (MPLS) circuits within our network. MPLS is widely accepted to be the premium service available for transporting digitized voice signals. Further, ***we use a mixture of G.711 and G.729a signaling protocol (codecs)*** and we dedicate enough bandwidth for each conversation over our private network to keep packet delays under 100 milliseconds which ***provides the ability to achieve an MOS of 4.3 (better than digitized telephone quality)***. The quality is transferred directly to our recordings as we use only digital recording equipment for playback of calls.

3.1.6 Continuity of Services

The vendor must provide sufficient redundancy and business continuity recovery capability to meet a three (3) hour Recovery Time Objective (RTO) and a zero (0) Recovery Point Objective (RPO) of all ITS components.

Describe how your solution provides operational redundancy, fault tolerance, and recovery so that services to DOCCS are not significantly diminished and that service levels, as defined in [Section 5](#), will continue to be met.

SECURUS HAS READ, AGREES AND WILL COMPLY WITH THIS REQUIREMENT.

Securus has designed and implemented a robust network architecture that provides for quick disaster recovery, minimizing downtime for the Securus platform and its customers. Securus has

demonstrated its ability to recover efficiently under extreme circumstances, restoring service to our customers with no data loss. Securus has a strong record of meeting various Recovery Time Objectives, based upon contractual requirements with our vast customer base, as well as a demonstrated track record of a zero (0) Recovery Point Objective, even when faced with catastrophic events. What does this mean? It means our system, processes and people WORK!!!

Risk Mitigation

Securus has implemented a platform and infrastructure designed to minimize potential outages and protect customer data. Multiple data centers, diverse network paths, redundant platform systems, and proactive monitoring mitigate the majority of risks.

Data Centers

Securus maintains a presence in three data centers in three geographically diverse locations. Our data centers are designed to withstand worst-case events and maintain 99.95% availability. The data centers, managed and staffed by a carrier-class data center host, meet or exceed the Telecommunications Industry Association’s (TIA) standard number 942 for Tier IV (highest availability) data centers including:

- Ability to withstand a 96-hour power event
- Two-hour fire protection
- Multi-layer physical security
- Multiple power delivery paths.

<p>Tier 1 – Basic Small Business</p> <ul style="list-style-type: none"> • 99.671% availability • Susceptible to disruptions • Single path for power • No redundant components 	<p>Tier 2 – Redundant Medium Business</p> <ul style="list-style-type: none"> • 99.741% availability • Less susceptible to disruptions • Single path for power • Redundant components
<p>Tier 3 Large Business</p> <ul style="list-style-type: none"> • 99.982% Availability • Planned activity without disruption • Multiple paths for power • Redundant components 	<p>Tier 4 Multi-Million \$ Business</p> <ul style="list-style-type: none"> • 99.95% Availability • Can withstand at least one worst-case event • Multiple paths for power • Redundant components

TIA-942 Infrastructure standards for data centers
Telecommunications Industry Association

Also, Securus data centers have redundant uninterrupted power systems, N+1 generator redundancy, and N+1 cooling redundancy. All systems and network equipment have redundant power paths. Multiple telecommunications carriers also serve each data center for load balancing and path diversity. Securus data centers are staffed 24x7x365 for immediate physical assistance inside the data center.

Multiple checks ensure data center physical security, including guarded, photo-verified check-in; dual-door authentication (card and biometric); and a mantrap (interlocking door controller) at the data center suite entrance.

Redundancy

Redundancy is a key component of the Secure Call Platform (SCP). While operating on a single platform, Securus’ SCP runs on duplicate environments in separate data centers in Atlanta, Georgia, and Dallas, Texas. Each component has N+1 redundancy, meaning that a failure of any one component does not result in downtime because there is a backup available to resume its function. In addition to the inherent redundancy of SCP, Securus has also designed redundancy into all support systems, either through N+ 1 configuration, database clusters, virtual machines,

load balancing, or other failover methods. All network transport has redundant network equipment and routing to allow traffic to reroute in the event of a failure.

The SCP platforms in Dallas and Atlanta were designed and built to the same specifications. This standardization allows re-homing of systems from their primary data center to an alternate data center in the event of a failure. As part of our Business Continuity plan we execute a disaster recovery exercise annually whereby we redirect traffic from one of our largest DOC customers from the Dallas data center to the Atlanta data center to confirm our ability to continue to service the DOC in the event of a catastrophic failure of our Dallas data center or vice versa. This capability assures that we will be able to meet your requirements of three (3) hour Recovery Time Objective (RTO) and a zero (0) Recovery Point Objective (RPO) of all ITS components.

All circuits coming into Securus data centers use multiple diverse carriers, including the interconnections between data centers. In the event of a failure, traffic will reroute across a redundant circuit or path. In addition, Securus uses multiple carriers for inmate calls from the SCP platform. Calls to family and friends will immediately reroute upon failure of any carrier.

Securus uses multiple methods of storage to minimize the risk of data loss. All critical systems and data are backed up at regularly scheduled intervals and stored offsite for retrieval, if needed. In addition to offsite storage, Securus replicates voice clips, call recordings, and validation data between the data centers.

Securus uses industry-leading vendors for all platform and network hardware, including Dell, Cisco, Oracle, EMC, Big IP, and Intel. In addition to the redundancy designed into the platform and network, Securus also maintains a spare parts inventory onsite at each of our data centers to expedite repair of a failed component. Securus also maintains premium-level support contracts with each vendor that defines stringent service level agreements in case of a failure.

Securus maintains an inventory of spare parts for our facility-based components at our headquarters in Dallas, Texas, and has distribution agreements with multiple vendors to provide expedited national delivery service. The corporate headquarters maintains a standardized emergency recovery package of frequently used spare parts and equipment that will be available for shipment to support restoration efforts at our customer sites. Our technical field representatives located throughout the country also carry an inventory of the most commonly needed spare parts. With spare parts on board our service vehicles, most facility-based equipment malfunctions can be resolved with a single site visit.

Proactive Monitoring

Data Centers and Network

Securus continuously monitors all data centers, infrastructure components, platform systems, and inmate telephone systems (ITS) using the SolarWinds® suite of network performance monitors. The SolarWinds performance monitors are highly configurable to provide real-time monitoring, event notification, alert history, and statistical information. An alarm condition creates immediate visual alerts and email notifications.

The Securus Network Operations Center (NOC) provides 24x7x365 monitoring for all Securus systems, including SCP, network, back-office systems, and data centers. The NOC proactively monitors these systems to ensure performance is optimal and uninterrupted. In addition to system- and network-level monitoring, the NOC also monitors real-time video surveillance and environmental alerts for our data centers. Securus maintains a fully redundant backup NOC at a separate physical location, should services be disrupted at the primary location.

The dashboard displays several key performance indicators and system health metrics:

- Average CPU Load & Memory Utilization:** Two gauges showing Avg CPU Load at 2% and Memory Used at 66%.
- Average Response Time & Packet Loss:** Two gauges showing Avg Resp Time at 1 ms and Packet Loss at 0%.
- Disk Volumes:** A table showing disk usage for C:\Users\Software2, Physical Memory, and Virtual Memory.
- CPU Load & Memory Statistics:** Summary of current average CPU load (0%), memory used (1.871 GB, 21%), memory available (6.715 GB, 79%), and total memory (8.589 GB).
- Node Availability Statistics:** A table showing availability percentages for Today, Yesterday, Last 7 Days, Last 30 Days, This Month, and Last Month.
- Active Alerts (0):** A section for all triggered alerts.
- Traffic & Percent Utilization of Each Interface:** A table showing interface status, name, receive, and transmit rates.
- Network Latency and Packet Loss - Now:** A bar chart showing response time and packet loss over time.
- Processes and Services:** A table listing various services and their CPU load, physical/virtual memory usage, and IOPS.
- Components:** A table listing system components and their statistics, messages, response times, and ports.
- Application Health Overview:** A summary showing 51 applications are Up, with counts for Warning, Critical, Down, Unknown, and Other.

SolarWinds® Typical Monitored System and Application Elements



Securus Primary Network Operations Center



Securus Backup Network Operations Center

Premise Equipment

The Securus Technical Support team provides 24x7x365 monitoring of all facility-based equipment and directly supports facility installations via telephone and email. Technical Support monitors connectivity for all installations and all installed equipment including integrated access devices (IADs), visitation phone monitoring (VPM) units, switches, and uninterrupted power supply (UPS) systems. The systems are polled every two minutes and their vital operating statistics sent every 10 minutes. Upon receiving an alert indicating network failure, Securus will open a trouble ticket with the appropriate circuit provider. In the case of a premise-based equipment failure, a Securus Field Technician is dispatched to the facility for on-site repair.

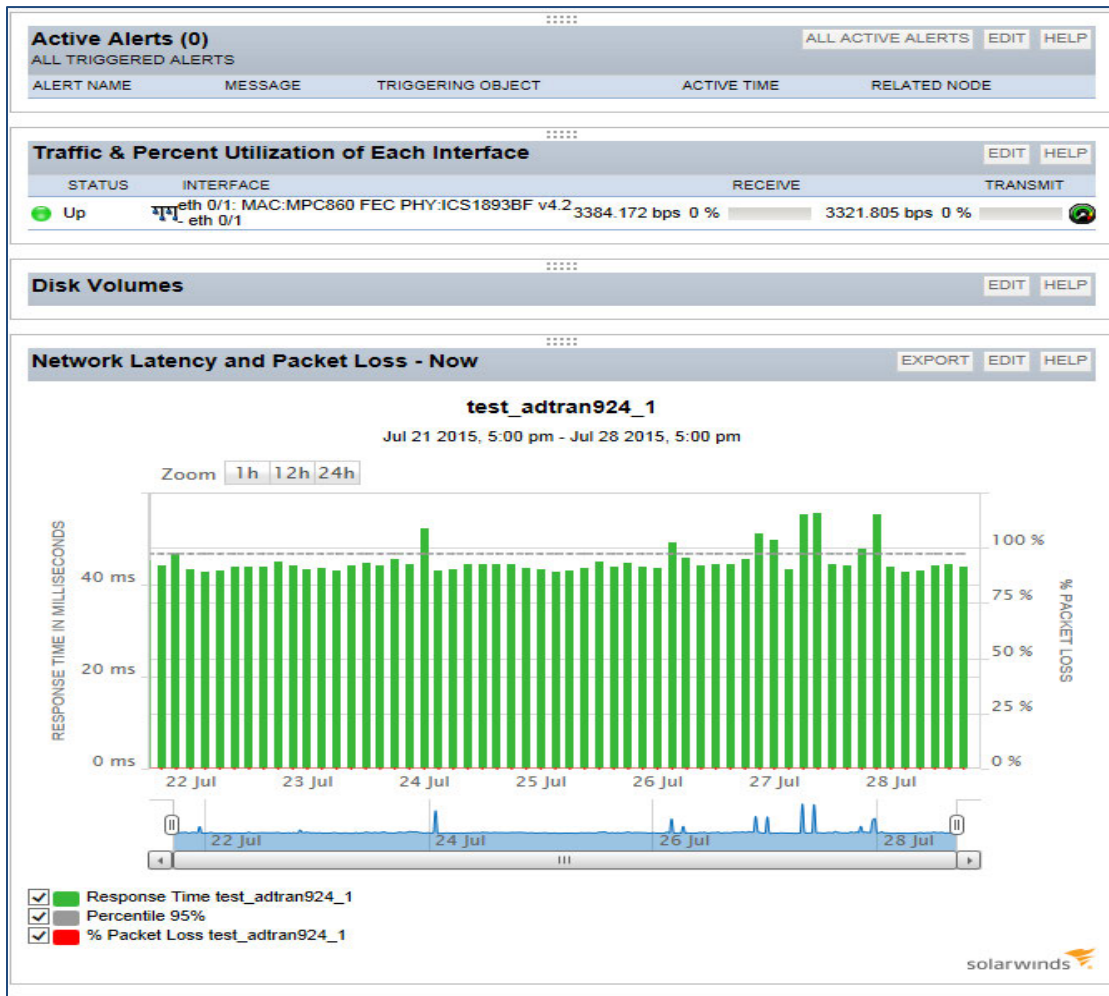

SolarWinds® Device Monitoring Example (Bandwidth & Network Latency)

In addition to real-time monitoring and alerting, Securus technical support also leverages the SolarWinds network performance monitor to gather and evaluate historical data for network alerts, bandwidth usage, packet loss, and hardware performance. The detailed level of monitoring available via our network performance monitor allows the technical support group to take proactive steps to prevent or mitigate facility outages and to ensure the correct resources are engaged if dispatch is necessary.

Restoration

Platform and Network

In the event of a disaster impacting SCP or our network, Securus immediately assembles a team of engineers to begin investigation and restoration of services. Securus maintains a schedule of on-call personnel for immediate response to service-impacting events and will also engage third party vendors, if required. If a state of emergency is declared, the Securus Business Continuity Plan will be activated.

Facility-Installed Systems

Securus prioritizes recovery of premise-based equipment by facility type and equipment location. Maximum-security institutions and institutions with high inmate phone usage receive priority. Prioritization also considers customer requirements and preferences. Securus has developed procedures and checklists to protect personnel and equipment in the event of an emergency situation. Securus will combine headquarters and field staff efforts to expedite service recovery wherever possible. Securus coordinates each checklist to ensure compliance with each facility's guidelines.

Securus has a field support department with more than 165 field service associates supported by a centralized field dispatch team. The Field Service Technicians (FST) are strategically located to support ongoing maintenance, as well as any disaster recovery situations. The FSTs are supported by senior technical support resources and engineering to expedite repairs and minimize customer downtime.

Reporting

Upon confirmation of a service-impacting event, the NOC will issue an internal service interruption report (SIR). The SIR will include the nature of the outage, impact to facilities, and estimated time of restoration, if known. Each incident is assigned an urgency level based on the level of customer impact.

Customer contact personnel receive SIRs, so they can communicate with customer facilities proactively or reactively as required by the facility. In addition, technical support may communicate a service-impacting event via a splash screen on the SCP user interface introductory page, whenever possible. Regular updates ensure that the information provided is always current. Securus executives also receive all SIRs, so they are aware of all customer-impacting events.

The NOC will issue a final SIR upon issue resolution. Securus investigates each incident and completes a root-cause analysis (RCA) following all service-impacting events. After the root cause is determined, Securus makes RCA documents available to customers upon request.

Performance

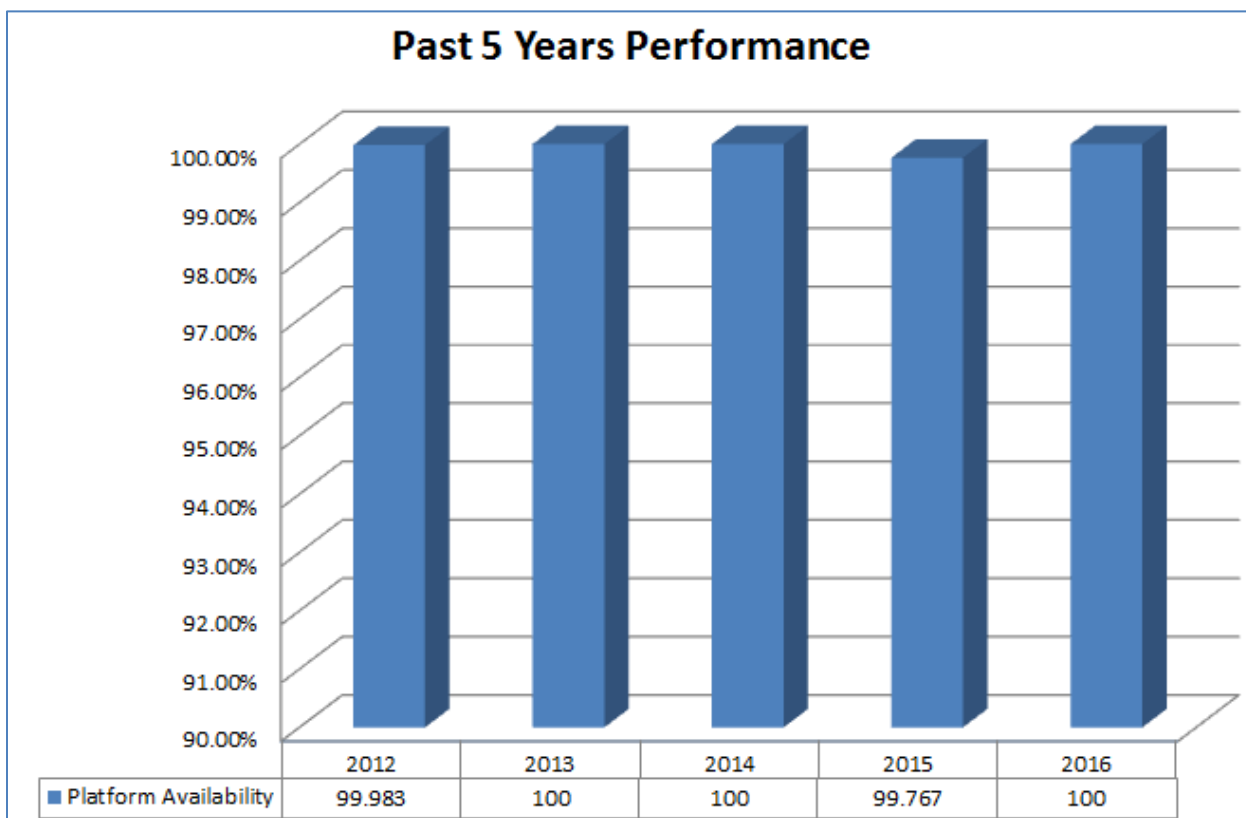

The SCP is one the most stable calling platforms in the industry, with nearly perfect, 100% availability. Through design, proactive monitoring, and rapid-response procedures, Securus minimizes customer-impacting outages. Data storage with multiple layers of redundancy minimizes the risk of losing critical data and recordings.

When disasters strike, Securus responds quickly and methodically to ensure the fastest restoration of service possible. And we have been tested.

In the spring of 2015, the Dallas, Texas, area, home to two Securus data centers, was impacted by weeks of significant storms, resulting in 27 deaths and more than one billion dollars of property damage due to flooding. Early one morning, lightning struck a Securus data center, damaging cooling units. Normally, this cooling would have been restored within minutes, but the roads leading to the data center were closed due to flooding, which caused a longer response time for service technicians. Securus' equipment rapidly overheated and began to fail. More than a quarter million dollars of components suffered fatal damage and needed replacement. Even with this once-in-a-lifetime series of compounding events, **calling services were restored the same day** for most facilities, and **there was no loss of customer data, investigative data, or recordings.**

3.1.6.1 Backup

The vendor shall be responsible for performing all system and database back-ups and archiving. The vendor shall provide all archival hardware, supplies, and network and recovery procedures to ensure that no data will be lost.

The vendor must back up all DOCCS information and store copies securely off site in compliance with DOCCS security policies. Vendor must certify the availability and integrity of back-up data and the media on which it resides.

Describe how you will meet these requirements including frequency of backups, off-site location(s) and security of transfers.

SECURUS HAS READ, AGREES AND WILL COMPLY WITH THIS REQUIREMENT.

Securus stores call recordings in centralized, disaster-resistant, carrier-class data centers. All equipment used to store recordings is monitored by the Securus Network Operations Center (NOC) 24 hours a day, seven days a week, and 365 days a year.

For redundancy, SCP writes all recorded calls to two separate Storage Area Networks (SANs), using two separate connections. Securus also archives all call recordings to an offsite storage facility for the third layer of redundancy. Recordings can be downloaded from SCP in various, widely-used formats and copied to a CD, DVD or any portable media.

The Securus SCP provides a unique set of features and advanced technologies to store call recordings.

Traditional premises-based calling platforms use local hard drives that may fail and are susceptible to local disasters. Premises-based systems needed manual backup schemes that are no longer necessary with SCP. SCP uses Storage Area Networks (SANs), special-purpose, high-speed networks that interconnect different kinds of mass storage and shared storage devices (such as disk arrays, tape libraries, and optical jukeboxes) with associated data servers.

The SAN architecture makes all storage devices available to all servers on the network. The SAN solution delivers complete scalability for a facility's storage requirements and supports disk mirroring, backup and restore, archival and retrieval, data migration from one storage device to another and the sharing of data among different servers in a network.

New storage devices added to a SAN become accessible from any server in the network. The SAN uses a series of standards to spread data across multiple drives for additional protection and redundancy. This technology enables the SAN to deliver superior performance and fault tolerance to disk failures ensuring data is no longer susceptible to drive failures. Accordingly, the SAN provides facilities with the ultimate protection against drive or server failures.

Within the SAN, SCP uses a combination of several RAID technologies including RAID5, RAID6, and RAID10. Even if one of the hard disk drive fails during the data recovery process, the system will continue to operate without data loss.

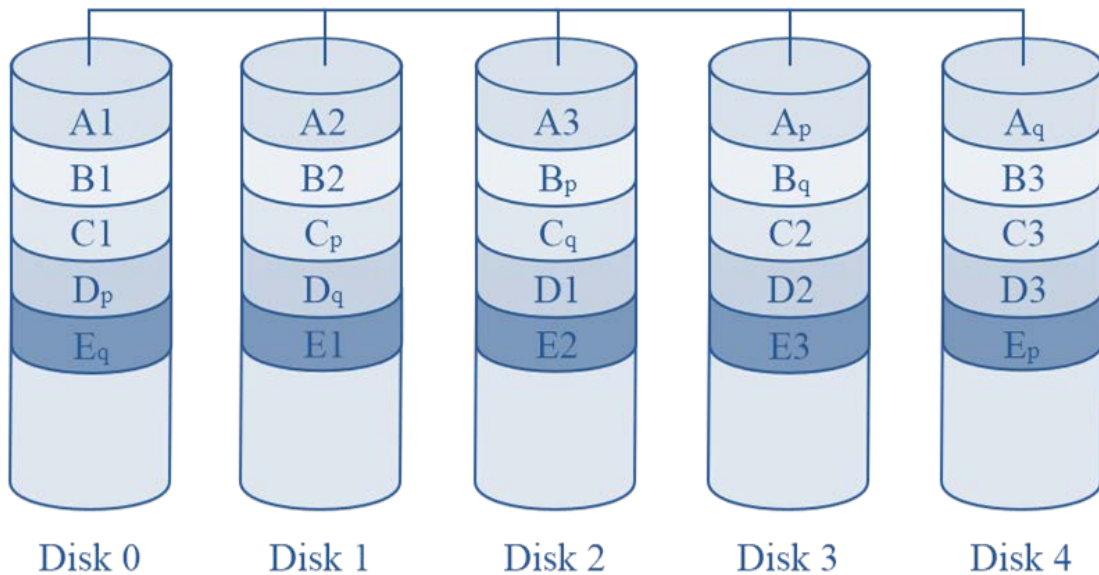

The Securus SAN has more than four (4) petabytes of storage space and is continuously monitored and managed through automated processes and storage policies. When these very large storage systems approach designated thresholds, Securus expands capacity to ensure all authorized call records and recordings are retained in secure, disaster-resistant locations.

The Securus data center storage solutions provide facilities with technology that is:

- **Scalable** to meet any facility's contractually required storage demands
- **Resistant** to local disasters through multiple copies stored within the data centers and off-site
- **Highly available** through the unique architecture and design of the data storage model
- **Partitioned and compressed** to run queries faster
- **Secure, protected, and monitored** to enable total recall of data

SCP records and stores basic call data with the capability to provide management reports. Securus does not limit the call data storage time. Since every site's requirements are different, Securus works with each facility customer to define their optimal data storage timeframe. All recordings are stored online as well as on remote copies. Typically, call detail records are stored for seven years.

3.1.6.2 Uninterruptible Power

The solution must assure no loss of ITS functions for a minimum of three (3) hours due to a loss of commercial power in the DOCCS' facilities. The vendor must provide an ITS capable of full recovery from a power outage automatically once commercial power is restored.

Describe how your solution will meet this requirement including what facilities and services DOCCS must provide.

SECURUS HAS READ, AGREES AND WILL COMPLY WITH THIS REQUIREMENT.

Uninterruptible Power Supply Facility Backup

Securus will maintain an uninterruptible power supply (UPS) backup for the equipment installed on DOCCS premises. Securus commonly uses uninterruptible power supply models, such as the Eaton 5PX UPS, which eliminates spikes, sags, surges, transients, and all other over/under voltage and frequency conditions, providing clean power to connected critical loads.

Eaton 5PX UPS



Combining extended runtime capabilities and exceptional efficiency, the Eaton 5PX UPS is a powerful enterprise class backup solution. An ENERGY STAR® qualified UPS, the 5PX's managed outlet segments allow you to monitor energy consumption down to the outlet level on its intuitive LCD screen, while convenient virtualization-ready bundles and Intelligent Power Software Suite enable seamless management in virtualized environments.

Calls In Progress

The Integrated Access Device (IAD) and uninterruptible power supply (UPS) maintain all in-progress telephone calls while blocking additional call attempts after the event. When power is exhausted (up to five hours with extended battery modules), the system terminates all calls in progress and powers down to a quiescent state that allows it to resume full operation automatically after the restoration of commercial power.

Uninterruptible Power Supply Data Center Backup

Securus operates and maintains two major data centers networked to the equipment installed on DOCCS premises. Each data center has an uninterruptible power supply (UPS), and a generator to provide maximum network uptime. The traditional data circuits (MPLS, Frame Relay, VoIP) all have dual connectivity feeds to/from the telecommunication carrier to each of our data centers.

The UPS systems in our primary data center have 2N redundancy. Dual source power runs through a static bypass switch. Battery rooms support the UPS systems with gel cell battery banks. Fifteen minutes of battery backup is available at full load (such as 90 watts per square foot). Each battery bank is continuously monitored to ensure optimal operation. Upon loss of commercial power for more than 15 seconds, paralleling switchgear automatically powers all nine generators; generators are shed to cover load as needed. Typically, the transition from UPS to generator power takes 60 seconds.

Data Center Power Conditioning

The uninterruptible power supply (UPS) system filters, spikes, sags, surges, transients, and all other over/under voltage and frequency conditions, providing clean power to connected critical loads. Power distribution units (PDUs) distribute power to individual customer racks via remote power panels. Each rack has redundant power strips (A & B) routed to diverse PDUs. Diverse uninterruptible power supply systems feed each power distribution unit.

Required DOCCS Facilities and Services

Securus has engineered the network architecture in such a way that there is no requirement to utilize DOCCS facilities and services. However, should DOCCS be willing to provide access to the facility backup generator power grid, Securus can connect the UPS infrastructure to this power grid to prevent any downtime at all.

3.1.7 Single Clock Source

The vendor shall ensure that inmate call processing equipment, call detail recording, and recorded conversations will be synchronized from a single time-of-day clock source for all of DOCCS' locations.

Describe how your solution will meet this requirement.

SECURUS HAS READ, AGREES AND WILL COMPLY WITH THIS REQUIREMENT.

Securus time servers are synchronized with NTP (Network Time Protocol) which uses UTC (Universal Time Coordinated, an evolution of Greenwich Mean Time) as our primary source for keeping all data center servers coordinated in time. NTP provides time keeping for millions of clients around the world.

Securus' private network consists of multiple time servers to ensure availability of time synchronization with the servers communicating with each other as well as communicating with

the atomic based Stratum servers provided by NTP to ensure an absolute, high accuracy and consistency of timing used for time stamping call and activity events. The Stratum time servers represent the single source of time synchronization. All applications and nodes within our network use the UTC, maintained by the Securus time servers, as a clock source reference. Applications within the Securus private network manage time zone offsets for purposes of display and reporting. For time stamps related to inmate calls, SCP user interface will automatically convert the UTC time stamps into the time zone defined for each DOCCS facility and automatically includes consideration of day light savings time. All of this attention to accurate time keeping, consistency of storage time zones, and automatic time-zone application of time stamps means that DOCCS will have confidence in accuracy and relevancy of the date and times presented throughout the SCP user interface.

3.1.8 Recording and Monitoring

The system must provide undetected monitoring of real-time inmate conversations, store and replay of historical conversations with the option of storing to removable media, and the ability to lock certain call recordings from deletion. These capabilities shall be provisioned to allow access to some or all features by unique user ID. (e.g. Facilities staff may only monitor calls in real time, while investigative staff have the full feature set.) All removable media must be encrypted. DOCCS is interested in understanding all features available for managing the recorded call search, playback, and copying processes.

Identify removable media to be provided and describe all features that will allow DOCCS to streamline and accelerate these functions and download selected recording(s) to external media if desired.

Describe how your solution will meet this requirement.

SECURUS HAS READ, AGREES AND WILL COMPLY WITH THIS REQUIREMENT.

The Securus Secure Call Platform (SCP) has an integrated recording and monitoring system. The automated system is designed to be a cost-effective solution for all correctional facilities of any size. Multiple levels of security provide that only authorized personnel can access and monitor the inmate recordings. Authorized personnel can listen to live or archived recordings via multi-media PC interfaces connected over local area networks (LANs).

SCP Recording and Monitoring:

- ✓ Provides undetected monitoring of real-time inmate conversations
- ✓ Stores and replays historical conversations with the option of storing to removable media
- ✓ Provides ability to lock certain call recordings from deletion.

Call Monitoring

The SCP Live application allows for real-time, undetected, monitoring of calls in progress via a multi-media PC workstation. Facility personnel (with appropriate privileges) can monitor live calls by highlighting the call in progress and clicking on the speaker icon. This process is undetectable

by the inmate or the called party and does not disrupt the recording process. Concise descriptions of activity appear for each phone in use. For example, the system shows the specific telephone location, inmate PIN, the destination number dialed, city and state of the destination, and start time and duration of each call. SCP also displays any restrictions such as “watched” or “private,” and the status of the call, such as “in progress,” “calling destination,” or “getting acceptance.”

SCP can also automatically eliminate all monitoring or recording of special calls, such as calls to legal counsel, by designating the number as a “private” number. SCP prevents all unauthorized attempts to listen to private calls—the user interface will not display the speaker icon to play private calls. The call record also lists the call as “private” on the user interface.



Call Monitoring, Silent (Undetected)

When monitoring occurs, the system incorporates analog suppression/amplification hardware that allows monitoring of calls without inmate or called party detection. There is absolutely no noise, volume loss, or other indication of monitoring to assure complete investigator anonymity.

Call Recording

The integrated SCP recording application works independently, so there is never a need for integration of a third-party manufacturer’s product. This allows the facility to deal with a single vendor if any issues arise.

The SCP uses large capacity hard drives, along with RAID (Redundant Array of Independent Disks), that virtually extend the call storage period to meet your specific needs. Recordings are stored on-line for immediate access for 12 months, or any other length of time required by DOCCS. The SCP can also burn the information to CD or DVD for additional back up, if necessary.

The SCP can record all calls simultaneously and allows personnel to listen to pre-recorded calls while active calls continue to be recorded. The system records the entire conversation from call acceptance to termination.

Remote Access to Recording and Monitoring

With integrated recording and monitoring applications, other agencies, such as the local police departments, can also access these functions. Any authorized user with an approved user name and password can easily, and remotely, access recording and monitoring of inmate calls from any computer or device with access to the Internet. Securus has tested and certified the playback of calls and live monitoring on:

- Operating Systems/Devices

- iOS
- Android OS
- OS X
- Windows
- Browsers
 - Internet Explorer
 - Firefox
 - Chrome

Removable Media

While call recordings may be downloaded onto removable media, the Anywhere, Anytime access afforded by the web-enabled SCP user interface eliminates much of the need to perform this task. Outside agencies can be granted very specific security permissions which allow them to only download recordings, or a desired set of recordings can be provided via electronic notification while maintaining the security of DOCCS system. Securus proposes encrypted flash drives for DOCCS such as the Kingston's DataTraveler Vault Privacy 3.0 USB flash drive.



Kingston's DataTraveler Vault Privacy 3.0 USB Flash drive provides affordable business-grade security with 256-bit AES hardware-based encryption in XTS mode. It protects 100 percent of data stored and enforces complex password protection with minimum characteristics to prevent unauthorized access. For additional peace of mind, the drive locks down and reformats after 10 intrusion attempts. It also features a read-only access mode (enabled via SafeConsole for the Managed model) to avoid potential malware risks.

SCP user interface supports the ability to store exported data including reports and collections of call recordings to removable media. Supported removable media include CDs, DVDs, flash drives, and similar devices. Many such removable media may be configured to support hardware level encryption of the data placed on them. SCP user interface is able to support the use of encrypted, removable media due to the encryption being performed by the computer system (including the removable media). The decision to use or not to use encrypted, removable media is therefore one that can be made by DOCCS personnel on a case by case basis in accordance with DOCCS data control procedures. Given the flexibility to use removable media – whether encrypted or not – along with the ability to give select users of the SCP user interface access only to what they need, DOCCS will have tremendous control over and agility to address the security of data access and exports.

SCP Features

SCP's centralized architecture and packet-based design creates the optimum combination of performance, quality, security, and end-user control on the market. The SCP system is **fully loaded** with our industry-leading patented features and functions and is virtually future proof and scalable. We update our system multiple times each year (at no cost to our customers) to make sure you *always* have access to the best technology in the industry – both now and in the future. Key SCP features are listed below, highlighting features available for managing the recorded call and copying processes.

KEY SCP Features	
Anywhere / anytime access	Anywhere / anytime access security
Automated operator	Billing name and address report
Billing name and address for dialed numbers	Call acceptance - called party
Billing name and address history	Call acceptance - inmates
Call acceptance - active	Call acceptance - passive
Call acceptance - dual party	Call acceptance - silent
Call acceptance - mute	Call announcement - rates
Call acceptance - positive	Call monitoring - controls
Call announcements	Call monitoring - kill call
Call announcements - balance	Call monitoring - scan patrol
Call duration - controls	Call monitoring - silent
Call monitoring - forward call	Call progression - controls
Call monitoring - media player	Call recording - archive configuration
Call monitoring - security and reporting	Call recording - burn to cd, dvd, ipod, usb
Call notification for monitoring/recording	Call recording - configuration
Call quality	Call recording - expiration
Call recording - burn for data playback	Call recording - management
Call recording - cd format selection	Call recording - security and reporting
Call recording - email configuration	Call recording - simultaneous
Call recording - labeling	Call restriction
Call recording - media player	Call restriction by time frame/period
Call recording - silent mode	Call set up prompt
Call recording - storage	Call termination controls
Call restriction by call type	Call tracker - recording and case note management

KEY SCP Features	
Call schedule controls	Call tracker - security
Call suspension	Call type - direct billed
Call termination warning	Call type - free
Call tracker - search	Call type - instantpay/paynow
Call type - advanceconnect	Call type - international
Call type - fcc	Call type - traditional collect
Call type - inmate debit	Call velocity controls
Call type - instantpay/text2connect	Call voice prompts
Call type - prepaid calling card	Chain of evidence
Call validation	Covert alert
Call voice overlays	Covert alert - email notification
Chain dialing prevention	Crime tip alert
Commissary order by phone	Facility portal - call detail reports
Covert alert - barge in	Facility portal - call type report
Covert alert - investigator acceptance	Facility portal - daily call volume chart
DTMF detection	Facility portal - online help
Facility portal - call frequency chart	Facility portal - quick look
Facility portal - commission reports	Facility portal - service ticket management
Facility portal - investigation tool	Global blocking list
Facility portal - order materials	Informant line
Facility portal - revenue reports	Integration with commissary
Facility portal - user management	Integration with trust
First calls free	Integration by e-imports
Global allowed number list	Language selection - english
Hook switch dialing prevention	Language selection - spanish
Inmate recorded name	Officer check in
Integration by web services	Officer check in - search
Integration with oms	On/off controls and security - phone(s)
Isolated talk paths	On/off controls and security - system
Language selection - multiple/additional (french, russian, etc.)	PAN auto list - refresh

KEY SCP Features	
Modify by customer, site, group, phone, pin, dtn	PAN - integration
Officer check in - reports	PAN - restrictions
Officer check in - security	Permablock
On/off controls and security - remote	PIN - configuration
PAN - auto	PIN - duplicate prevention
PAN - inmate managed	PIN - integration
PAN - manual	PIN - restrictions
PAN - verified/not verified	Private/privileged call schedules
Phone service for hearing impaired (tdd/tty)	Quick call download as wav
PIN - controls	Remote call forward detection controls
PIN - generation	Remote call forward detection flag
PIN - profile	Remote call forward detection warn
PIN - schedules	SCP report - advanced searches
Private/privileged calls	Outbound dialing
Real time change application	Remote information sharing
Remote call forward detection disconnect	SCP report - call frequency
Remote call forward detection real time	SCP report - emergency call
SCP notification screens	SCP report - rcfcd action configuration
SCP online help	SCP report - informant line
SCP report - ad hoc ability	SCP report - pan frequency detail
SCP report - call detail	SCP report - saves
SCP report - debit	SCP report - voice biometrics frequency
SCP report - export to excel, csv, pdf	Secure instant mail
SCP report - hourly usage	Security by role
SCP report - pan frequency	Security templates
SCP report - pan management	Speed dial
SCP report - tips	System log - latest activity
SCP report - voice biometrics status	System log - pan entry change
Security by ip address	System log - recording log
Security multi-passwords	System log - security template change
Voice biometrics	System log - user management change

KEY SCP Features	
System log - custody account change	Three way call detection disconnect
System log - management change	Three way call detection warn
System log - phone number change	Virtual phone groups
System log - scan patrol log	Voicemail controls
System log - system access	Voicemail outbound
Three way call detection controls	Word spotting
Three way call detection flag	Word spotting dictionary
User management	Word spotting controls
Visitation phone monitoring and recording	Water Marking
Voicemail inbound	Watched numbers

3.1.8.1 Investigative Support

The vendor shall provide live, real-time investigative analysis that allows authorized users employed by the vendor and by the Department to view and analyze a percentage of call data to establish links between selected inmates and called parties, to include activities such as gang, drug, victimization, extortion, and other nefarious activities.

The system should also be able to provide reports on call-pattern analysis and call-volume distortions in real time.

Describe the proposed system’s ability to fulfill the real-time analysis requested above, the number of analysts, and the percentage of calls that will be analyzed.

SECURUS HAS READ, AGREES AND WILL COMPLY WITH THIS REQUIREMENT.

The following is an overview of the Securus Investigative Support offering:

Investigative Support Powered by Guarded Exchange (GEX), a Securus Company

Securus provides a comprehensive suite of investigative products and is the industry leader in live monitoring of inmate calling. Our solution includes the most advanced technology available integrated into a single, cohesive system whose sole purpose is to aid agencies in generating Actionable Intelligence™.

Securus’ Guarded Exchange Investigative Support Solution includes:

- Live Analyst Call Monitoring.

- 70 proprietary technologies that allows Securus' skilled Communication and Investigation Analysts to data mine through millions of phone calls, emails, financial transactions and other information sources providing intelligence that counts.
- Nearly 100 highly trained and skilled analysts, with over 450 years of combined experience. Out of that comes over 275 years of Corrections, Law Enforcement, and Investigative backgrounds.

Securus' Guarded Exchange Solution provides experience that can only be achieved through time tested processes and solutions.

GEX has monitored over 4 Million Calls and this number grows every day.

NM DOC, KY DOC, MO DOC, PA DOC and FL DOC utilize these services daily.

As calls are processed through the inmate telephone system, and analyzed using Securus' full array of investigative support services, agencies are able to enhance their investigations while adding efficiency and productivity.

Securus will also layer in our Investigative Support team, a 100-plus person investigative force—soon to be over 200, mostly having a Corrections and/or Law Enforcement background that work alongside and at the direction of DOCCS investigators to uncover leads and deliver results to focus investigations and close more cases. This combination of capabilities will provide the greatest level of security and investigative value for DOCCS.

Securus has been delivering experienced, certified, professional investigative support personnel to provide live monitoring of calls longer than any other vendor. As such, we have developed tools and processes that are refined and proven to be effective.

Securus' Guarded Exchange Investigative Support Solution was the first of its kind in the nation and other vendor solutions cannot match the experience and effectiveness of their capabilities.

As such, we have developed tools and processes that are refined and proven to be effective in large scale DOC environments. These are tools that no other vendor can replicate or provide.

Securus has been providing live call monitoring and Investigative Support for the State of Missouri Department of Corrections (MO DOC) for more than five years enhancing the investigative effectiveness of the DOC.

We urge caution when evaluating other vendors' offerings, as the promise of monitoring calls cannot be effectively achieved without experience and full integration with your investigative suite of tools.

Effective live call monitoring is a function of three things:

1. The number of trained personnel available to listen to calls
2. The level of comprehensive understanding of what your investigators are looking for in calls, and
3. Having full integration into your investigative software and systems so that “Actionable Intelligence™” derived from calls can reach investigators in a timely manner

Securus offers these monitoring services as an integral part of the overall investigative and intelligence gathering suite of services that other vendors simply cannot match.

Offender calls to be monitored will be targeted based on the use of proprietary data mining, behavioral analysis and filtering technologies and other proprietary strategies in conjunction with the intelligence gathering priorities established by the DOCCS.

With our built-in investigative support program, Securus will provide the largest and best-trained set of personnel to listen to and review as many calls as required by the DOCCS.

For this deployment, we are offering to provide monitoring of up to **7% of all inmate telephone calls**. That translates into more than **1.5 million calls** annually and potentially an excess of **10 million calls** over the life of the contract.

In providing the monitoring and reviewing of offender calls, Securus, through our Investigative Support team, will incorporate any data mining strategies established by the DOCCS investigative teams. The monitoring will use a combination of proprietary technology and our highly trained investigative personnel for the purposes of collecting intelligence from inmate calls completed using the proposed SCP ITS.

The use of these trained personnel, proven strategies and technologies will identify at a minimum the following:

- Suspicious or suggestive key words or phrases
- Calls that suggest threats to the safety and security of the facility, staff, volunteers, and inmates entrusted to the care of the DOCCS
- Criminal activity inside and outside of the facility

This extension of the DOCCS’ investigative tools will assist you daily in meeting your investigative goals and objectives, including assistance with identification of owners of contraband cell phones or additional focused support on high profile cases.

This is an important feature of the investigative support team. While daily monitoring of calls is a primary goal and activity, upon request from DOCCS, the team can be quickly redirected to a targeted subset of calls with the ability to monitor and report on thousands of calls in a matter of hours or days, rather than the weeks required by our nearest competitor. No other vendor is equipped to perform in emergency or high security situations, such as escapes, disturbances, and

gang/STG activities. Securus is not only equipped, but we have performed and delivered in just these types of situations repeatedly for our customer partners.

Securus will submit all gathered Actionable Intelligence™ upon discovery in a format agreed to by the DOCCS. Securus will create an account team consisting of Investigative Specialist(s) to provide daily and/or weekly business meetings with the DOCCS investigative teams. The purpose of the meetings will be to review the on-going success of the program, make adjustments as necessary and to discuss creative solutions that may enhance the program.

Securus will suggest and recommend programs that have proven successful through our existing monitoring of calling for the Missouri Department of Corrections (MO DOC) where we are currently monitoring over 70,000 calls per month.

Please note: detailed documentation of a third-party study completed examining the effectiveness of call monitoring at the Missouri DOC is available upon request.

Digital Forensic Services

In addition to Securus' Communication and Investigative Analysts, we also staff Certified Digital Forensic Examiners and Certified Cellebrite UFED Touch Users. This provides both State and Local agencies with the ability to receive extracted cellular data from confiscated phones alongside proactive call monitoring.

Cellular Forensics brings another level of examination to the Securus investigative support solution. Examiners provide a comprehensive and analytical breakdown of cellular data utilizing Cellebrite and numerous other Computer Forensic programs (Encase, Internet Evidence Finder, Passware, Oxygen Phone Forensic Suite, and Forensic Explorer) that are also able to perform in-depth forensic analysis on acquired devices as well as any form of digital media. To date, we have processed over 2,000 devices. We currently have labs in Jefferson City Missouri, and the Central Office of the Florida Department of Corrections.

Our Forensic Examiners are also certified to perform data extraction of devices that are damaged, locked or unsupported by other forensic tools using the latest Chip-Off Forensics technique.

Chip-Off Forensics is the process of removing the flash memory from the printed circuit board of a device using either a heat or no heat method, depending on the purpose of the extraction, and reading and analyzing the raw data stored on the chip.

The ability to perform this process allows agencies to access more locked and damaged devices than ever before; thus, adding to the potential of vital intelligence and data gathered from devices.

The combined experience of our Forensic Staff combined with the Industry Leading Hardware and Software would ensure that the highest quality of Digital Forensic Services on mobile devices, and any digital media, would be of the highest standard.

For this deployment, we are offering to establish a Digital Forensics Lab at a location to be determined by DOCCS for the exclusive use of the Department. We will staff this lab with up to 6 technicians and support staff, giving the state the ability to have as many as 200 devices per week processed.

3.1.8.2 Simultaneous Access

Recording or monitoring equipment may be centralized or hosted and shall have the capability of undetected recording of every completed inmate telephone call for the duration of that call. The vendor shall provide the ability and bandwidth for a minimum of 20 simultaneous users who can listen to any recording at one time at any facility or any combination of facilities while continuing to meet the requirements of [Section 3.1.4, System Trunking](#).

Describe how you intend to meet this requirement, explain whether the recording will be hosted or centralized, detail the bandwidth and equipment requirements required to meet this objective.

SECURUS HAS READ, AGREES AND WILL COMPLY WITH THIS REQUIREMENT.

SCP UI, as a centralized system, is scaled to allow for simultaneous access from all serviced facilities across the country

- 20 additional, simultaneous users is not a problem
- Securus maintains a 24x7x365 NOC for monitoring performance and capacity to address capacity bottlenecks before they become service impacting

Data networks for accessing call recordings are engineered separately from those necessary to carry the inmate call traffic

- Call recordings are maintained in a centralized, Securus data center

Securus will engineer the facility access data network(s) to accommodate streaming of at least 20 simultaneous call recordings.

3.1.8.3 Storage

The vendor must store all call recordings and associated call detail records for twelve (12) months at no additional charge to DOCCS. All calls locked by DOCCS for investigative purposes shall be stored indefinitely by the contractor and remain available throughout the life of the contract period at no cost to DOCCS. At the end of the contract period, all locked calls will be turned over to the succeeding contractor without additional cost to DOCCS.

SECURUS HAS READ, AGREES AND WILL COMPLY WITH THIS REQUIREMENT.

SCP's Call Tracker feature can extend the expiration of a recording. At times, investigators do not want recordings from active investigations purged from the system—regardless of the recording retention policy in effect. Authorized users can protect a recording from being purged by extending the expiration of the call by 30, 60, 90 days, or for the life of the contract by selecting the Extend Expiration icon.

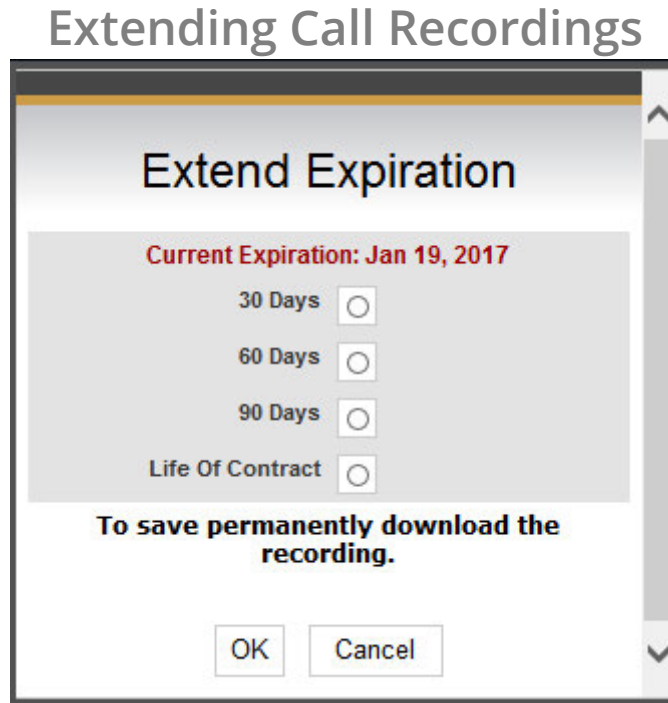

At the end of the contract period, all locked calls will be turned over to the succeeding contractor at no additional cost to DOCCS.

3.1.8.4 Chain of Evidence

The vendor must assure that the chain of evidence is protected when copying recordings to removable media and vendor must provide the software or tools necessary for playback.

Describe how you will provide this function and explain its capabilities.

SECURUS HAS READ, AGREES AND WILL COMPLY WITH THIS REQUIREMENT.

The Securus Secure Calling Platform (SCP) provides a patented method for ensuring the authenticity of inmate call recordings made through the platform. This security feature—the Chain of Evidence—is a key component of SCP and is automatically included in all installations. The Chain of Evidence prevents tampering with the call detail record and call recording. SCP encrypts, time-stamps, and verifies the authenticity of each recording.

SCP meets or exceeds the Rules of Evidence used in state and federal courts for the admissibility and authenticity required in a court of law.

In addition to the Chain of Evidence provided through SCP, Securus will provide expert staff to testify, at no cost to DOCCS, to the authenticity of the call recordings made on SCP.

Chain of Evidence

A phone call made on the Securus SCP creates a record, known as a call detail record (CDR), which includes—at a minimum—the following information:

- Customer name
- Facility name
- Originating station
- Destination number
- Start and stop time of the call
- PIN, if used by the facility

This information provides context information about the call. It is this context that differentiates a typical recording from one that can survive an evidentiary challenge to its authenticity. SCP combines this contextual information with the audio data in memory and writes the information to disk as a continuous data stream. It is not possible to modify the recording after recording to disk, and each recording contains the critical information about the authenticity of the data.

Storing this data in one combined unit creates a strong audit trail for identifying and proving the origin of the recorded call.

Creating the Audio Data

The recording process starts as soon as the called party answers the phone. This provides a record of the entire interaction between the SCP and the called party before the called party accepts the call. This interaction includes everything the called party says and all voice-over announcements, including the following information:

- Location of the originating call
- Inmate name
- Call rates
- Call acceptance
- Notification messages, such as the standard announcement that the call is subject to monitoring and recording

The recording is “complete” in real time and does not depend on the inmate and called party ending the call to have a “header” or other information written into the CDR. This feature is significant because the recording package is constructed real-time throughout the call and is un-editable, or locked, with all of the required data to identify the call. This guarantees that any

recording produced for legal purposes is the original data (recording and call details) and cannot be modified.

Downloading Calls as Evidence

SCP allows authorized users to copy recorded conversations to any external media device connected to the user's PC, such as CD, DVD, mp3 player, or USB drive. This feature facilitates easy sharing of recordings for investigative or court purposes. To maintain the accuracy of data and recordings during downloading and copying, SCP stores the files—both audio and CDR information—embedded within an industry-standard read-only format that prevents the possibility of tampering. In addition, when a user downloads any recording or recordings to external media, the download includes the player software and everything that user needs to utilize the relevant information.

"I estimate that I request phone records for eight out of every ten subjects I investigate, and of the 100 subjects that I have helped convict over the past four years, probably half of those were because of telephone recordings provided by the Securus platform. Securus has been so successful in assisting with my cases that the US Attorney's Office has asked me to get inmate calls for all cases."

- *Master Police Detective Michael Wachsmuth, a Tactical Field Officer working with the Alcohol, Tobacco, and Firearms division of the Federal Justice Department.*

3.1.8.5 Retrieval

The system shall permit authorized staff to attach textual descriptions or "notes" to each recorded call record allowing for descriptions of the recording. Each recording must be indexed by date, time, Automatic Number Identification (ANI), Personal Identification Number (PIN), Terminating Number (TN), and textual "notes." Date and time stamps shall be identical to the date and time stamps recorded in the system's call detail records and call processing equipment. The recording must be searchable by date, time, inmate's PIN, ANI, TN, "notes" or any logical combination thereof. Search and retrieval of recorded conversations shall take no longer than 20 seconds. Search and playback of calls will not require a manual media change.

Describe how your solution will meet or exceed these requirements.

SECURUS HAS READ, AGREES AND WILL COMPLY WITH THIS REQUIREMENT.

The Securus Secure Calling Platform (SCP) allows authorized users to add notes and tracking numbers to call detail records associated with recordings. Using this feature, known as Call Tracker, users click the notepad icon located in the call detail record, to add notes to an inmate call. The Call Tracker feature gives authorized users the ability to add a tracking number, gang

affiliation, duration into the call, and any other notes associated with the call. This feature also allows authorized users to either keep the note private to their investigation or to share the note with other users. From the Notes screen, users may also view previous notes associated with the same call.

Adding a Note to a Call Detail Record

The screenshot displays the 'Call Detail Records Search' interface. At the top, there are navigation tabs: HOME, SYSTEM, MONITOR, TOOLS, ADMIN, and FACILITY PORTAL. Below this is a 'MANAGEMENT LEVEL' section with dropdown menus for Facility (Securus Demo Site), Site (All Sites), Phone Group (All Phone Groups), and Phone (All Phones).

The 'Call Detail Records Search' section includes a 'FILL IN SEARCH CRITERIA' form with various fields:

- Country Code, Custody Account #, First Name, Termination Category, Call Type, Date Criteria (set to Date/Time Range, Start: 04/21/2011 00:00:00)
- Dialed Number, PIN #, Last Name, Blocked Reason, Call Status (set to Complete)
- Destination Zone (set to -- ALL --), Prepaid Account #, International, Watched, Private, 3-way, and Voice Biometrics checkboxes.

Below the search form is a table of '140 Results'. The table has columns: SITE, PORT LOC, DIALED #, START, END, DUR, and ACCT #. A blue arrow points from the first row of the table to the 'Add Note To CDR' modal window.

The 'Add Note To CDR' modal window contains:

- Tracking #: 4422
- First Name: Cora
- Last Name: Conklin
- Do Not Share:
- Available Users: Colby Koath, Cory Hutchinson, Courtney Johnson, Craig Charboneau
- Selected Users: (empty)
- Notes: Attaching to Case #4422
- Buttons: View Previous Notes, Cancel, Save Note

When searching for Call Tracker entries, users can navigate to the Call Tracker Search Tool. The Search Tool allows users to search entries by tracking number, authorized user name, phone number dialed, inmate account number, and PIN. Users can also complete a full-text search on the notes added to the call, such as gang affiliation and the start or end date of a call. As with every report in the SCP user interface, the search results are exportable to Excel, PDF, or CSV.

Searching for Call Tracker Records

HOME SYSTEM MONITOR TOOLS ADMIN FACILITY PORTAL

MANAGEMENT LEVEL
 Facility: Securus Demo Site Site: All Sites Phone Group: All Phone Groups Phone: All Phones

Call Tracker Search

FILL IN SEARCH CRITERIA (* indicates Required Fields)
 (Use * for wild card / partial searches)

Not Shared: Tracking #: _____ First Name: _____ Last Name: _____
 Custody Account #: _____ PIN #: _____ Dialed Number: _____
 Notes: _____

Start Date/Time: 05/19/2010 End Date/Time: 04/19/2011 Results Per Page: 10

Search EXCEL PDF CSV Reset

2 Results PAGE 1 OF 1

CDR	TRACKING #	TRACKER NAME	DIALED #	ACCT#/PIN	NOTE
		Dee Sonti	9722770596	0343 0343	share all
	S272010	Huong Allen	9722770596	S252010 S252010	This is Huong test

Searching and Retrieval of Recordings

HOME SYSTEM MONITOR TOOLS ADMIN FACILITY PORTAL

MANAGEMENT LEVEL
 Facility: Securus Demo Site

Recording Management

ADD NEW

NAME	CD IMAGE
018963 Investigation	
018963 Investigation	
Conidin	Download CD Image

Recording Management
 Folder Name: _____

ITE	PORT/LOC	IN/OUT	NAME	PIN	START	END	DUR
Securus Demo Site	LP 1	(1)			08-10-2011 00:30:43	08-10-2011 00:34:04	33 (s) 1.00(m)
System	LP 1	(1)			11-03-2010 10:16:37	11-03-2010 10:16:43	6 (s) 0.1(m)
Securus Demo Site	LP 41	(1)			11-02-2010 13:55:34	11-02-2010 13:56:28	52 (s) 0.87(m)
System	LP 1	(1)			11-02-2010 08:34:30	11-02-2010 08:34:42	12 (s) 0.2(m)

Create Selected Move Selected Total Files: (3/3) MB Total: (147) Seconds Total: (4) Minutes Total: (0)
 Selected Files: (3) Total Files: (3) MB Total: (147) Seconds Total: (4) Minutes Total: (0)
 The percentage shown below includes space reserved for the additional files necessary to support and play back the recordings.
 Delivery Method: CD (24.5% of 750MB) DVD (71% of 4500MB) Email Options: Email With Link
 OGG File (Original Recording): Wave File (Same size as OGG): GSM Files (20% size of OGG): MP3 Files (50% size of OGG):

Create CD Image Download CD Image Cancel

Securus allows investigators to access to all investigative tools via a single web portal known as the SCP user interface.

Investigators can search for calls using criteria such as:

- ✓ Called Party (TN)
- ✓ Calling phone (ANI)
- ✓ Date
- ✓ Time
- ✓ PIN
- ✓ Account
- ✓ Duration
- ✓ Locations
- ✓ Single site or Group of sites
- ✓ Call attempts
- ✓ Just completed calls

Investigators can listen to recordings, within the limits of their security access, using SCP's powerful call player. The player includes easy-to-use search capabilities, and features such as pause and fast-forward. A visual waveform helps investigators bypass areas of limited talk time and to quickly identify particular events.

When listening to a recording, the audio is "streamed" to the user's computer. This safeguards the original recording. Chain of Evidence safeguards prevent access to the original recording to eliminate any chance of intentional or accidental manipulation or deletion.

Calls less than one year old can be retrieved within the requested timeframe. Call recordings that are marked "store for life of contract", could take slightly longer to retrieve because of the required data mining.

3.1.8.6 Equipment and Network Access

Network access and all equipment or software required allowing DOCCS to monitor, retrieve, playback, and store recordings to removable media, or print local reports shall be provided by the vendor. All removable media must be encrypted by the proposed system. Any equipment to be deployed must be approved by DOCCS. DOCCS currently has approximately one workstation per facility and approximately 67 remote workstations with this capability. DOCCS reserves the right to add additional workstations at no additional cost to DOCCS.

Describe all alternative methods available to access and monitor live and recorded calls from portable devices, including but not limited to, laptops, tablets, and smart-phones. Include all system features available and all standard system features not available through these devices. Identify how access from these devices is authenticated, managed, identified and tracked and the security features associated with each type of access.

SECURUS HAS READ, AGREES AND WILL COMPLY WITH THIS REQUIREMENT.

Remote access allows DOCCS users the same features and functionalities permitted by the user's level of access, available on a Securus-provided workstation.





Because the recording and monitoring applications are fully integrated into the system, our Inmate Telephone System is extremely user friendly. The system allows for remote access by other agencies, such as the local PD's, without residing on DOCCS network. Any authorized user with an approved user name and password can easily and remotely access recording and monitoring of inmate calls from any internet connected PC. The system automatically provides the encryption that is used on removable media data, and ensures court-admissibility. Securus will work with DOCCS to have all deployed equipment authorized and approved in advance of implementation.

Historically, Securus features have relied upon the Microsoft Internet Explorer web browser; however, as the needs of our users have changed, and access methods have advanced, Securus is once again rising to meet these needs. Our dedicated team of developers continues to work tirelessly to ensure the Securus solution is not tied to one particular device or browser.





















User Interface Flexibility

Securus has designed and developed the user interface of SCP to function in most web browsers and on nearly all internet-connected devices. Because there are differences in software and hardware specifications across the various providers, Securus has included a basic list below that outlines the capabilities available for each. Using these browsers, users can access the software and perform their authorized functions from a multitude of devices including laptops, smartphones, tablets and iPads. This access is provided in a similar fashion regardless of the device, ensuring the absolute best user experience. From each of these devices, a user simply opens a browser, navigates to <http://www.commandcenter.securustech.net> and enters their username and password. The following charts depict basic functionality available with each type, but are not intended to be a comprehensive list. It should also be noted that the audit trail (tracking) and security features for each user are exactly the same, whether using a laptop, desktop or mobile device.

Opera, Chrome, and Firefox Brower Playback Capabilities

Function	Description	Supported ?
Audio Recording Playback	Playback audio recordings from CDR, Call Tracker, Informant Line, Emergency Call, Covert Alert, Officer Check In reports, and Basic and Advanced audio recording	
Video Recording Playback	Playback video recordings from CDR report (CT DOC functionality) (requires QuickTime)	
Clips Playback	Playback clips created for Pre recorded Name, Voice Biometric utterances, Advanced CrimeTip	
Live Call Monitoring	Listen to a call during Live Call Monitoring	

CD/DVD Recording Capabilities

Function	Browser /			
	Internet	iPad	Android	New Browsers
Create CD Image				
Download CD Image				
Send CD Image via Email				
Open CD Image				
Playback from CD HTML page				

Although the software is now available for multiple browsers, the official browser for the SCP UI remains Internet Explorer.

3.1.8.7 Access to Recordings

Access to live monitoring or recordings must be controlled by a multi-level password authentication that provides at least the following differentiating functionality:

- listening to live conversations only
- listening to live or recorded conversations with the ability to store to removable media

Describe how your solution will meet or exceed these requirements.

SECURUS HAS READ, AGREES AND WILL COMPLY WITH THIS REQUIREMENT.

The Securus Secure Call Platform (SCP) provides an advanced, multi-level password scheme specifically designed to provide facility administrators the ability to assign unique levels of access to anyone using the different features of the SCP. There are view and change options for each module depending on the need of the user. This allows administrators to give users permissions to only listen to live conversations or, perhaps, to listen to both live and recorded conversations and control the ability to store them to removable media.

Manage, Create, Edit, Predefine User Levels in SCP

The screenshot displays the 'Security Templates' management interface in the SCP Admin console. The interface includes a navigation menu (HOME, SYSTEM, MONITOR, TOOLS, ADMIN, FACILITY PORTAL), a 'MANAGEMENT LEVEL' dropdown set to 'Facility', and a 'Security Templates' section with an 'ADD NEW' button. A table lists various templates with columns for NAME, DESCRIPTION, and PREDEFINED. A callout box highlights that administrators can manage, review, edit, and delete all security templates, predefine templates, and add new templates as required from one location in SCP. A blue arrow points from the callout to the 'Admin - No Monitor' template row.

NAME	DESCRIPTION	PREDEFINED
3rd Shift - blocking only	Night jailers can block number but no changes otherwise.	
5.0 Huong test	Huong test	
5.0.1 Add Template	Huong Test	
5.1Huong Test	Huong test	
ADC-test1	This is for the demonstration	
ALL BUT NO 3 way	ALL permissions but no 3 way	
ALL BUT NO FREE	All but free	
Adam all	Everything	
Admin - Crime Tip Modify	Crime Tip Modify Access Admin	✓
Admin - Crime Tip Read	Crime Tip Read Access Admin	✓
Admin - Informant Line Modify	Informant Line Modify Access Admin	✓
Admin - Informant Line Read	Informant Line Read Access Admin	✓
Admin - No Monitor	Administrator w/o Live Monitoring Rights	✓

The administrator may modify the initial access levels or create additional levels based on facility clearance objectives for each tool. SCP generates a user log with the user name, time of access, and modules accessed.

Create New Security Templates

Administrators can create new security templates based on unique requirements.

MANAGEMENT LEVEL
Facility
Securus Demo Site

Create New Template

FILL IN TEMPLATE INFORMATION (* Indicates Required Fields)

Name: Sheriff Access *

Description: (200)

CONTROLLED AREA	CAN VIEW	CAN CHANGE
Admin - Security Templates	<input type="checkbox"/>	<input type="checkbox"/>
Admin - User Management	<input type="checkbox"/>	<input type="checkbox"/>

Create Cancel

Additional Password Policy Options

SCP provides flexible Password Policy options, enabling administrators to customize login security to meet their needs. Passwords can be configured by location, length, days to expire, and even the number of password cycles before password reuse. Additional configuration options include reminders for password expiration and minutes of allowable inactivity before session timeout.

If a user does not change their password before expiration, the user must contact the site administrator for password reset. This administrator assigns a random password and requires the user to create a new password when they log in.

Password Configuration Options in SCP

Customer Detail

CUSTOMER INFORMATION

Id: D-99001 Name: Securus Site Code: SECUR State: TX

Description: Securus Demo Site Status: ACTIVE Sites: Kellway Test Lab Allen, Mayberry Police Department, Mayberry Police Department, Production Support

Timeout (minutes): 420 Enforce Strong Password: YES Enforce IP: NO

Password Policy:

Min Length: 8 Max Length: 14 Password History: 12 Days to Expire: 30

Expiration Reminder: 5

Applications Available: SECURE CALL DEBIT, EDADV

Accessed Applications: ADMTOOL, SCN, EDBAS, EICONFIG

Passwords can be customized in length, duration, recurrence and more.

Cancel Update

The “Forgot Your Password” feature available from the login screen offers online support for users who have forgotten their password. System security requires users to provide the correct answers to preset questions before their password can be reset. Once a new password is created, SCP emails confirmation to the address linked to the user ID.

3.1.8.8 Call Monitoring Suppression

DOCCS desires the ability to disable real-time call monitoring of calls made to specific speed dial numbers (e.g. *77) or 10-digit numbers at the facility and system level. Disabling call monitoring must not prevent these calls from being recorded.

Describe how your solution can provide this capability.

SECURUS HAS READ, AGREES AND WILL COMPLY WITH THIS REQUIREMENT.

Securus provides the ability to disable real-time monitoring of calls made to specific speed dial numbers or 10 digit numbers, while also recording calls to these numbers.

Utilizing the capabilities in the Global List section of the SCP user interface, an authorized user can enter a specific number or speed dial, create a Covert Alert and then mark the “Hide Call” option. This option allows calls to be placed to the number and recorded, but will hide the call events from the Monitoring screen.

Alert Phone *	Alert Email	Alert Location *	First Name *	Last Name *	Status *	PIN	Hide Call	Geo Fence	Last Updated
9722770433		OTHER	HIDDEN	CALL	ACTIVE		<input checked="" type="checkbox"/>	---	N/A

3.2 Systems Management

The contractor must provide the following system management functions. Describe how your proposed solution meets each of the following requirements in this section.

3.2.1 Fault Management

The bidder’s solution must provide fault management capabilities that recognize, isolate, correct and log faults that occur in the system. The vendor must provide DOCCS with real time on-line notification of all systems alerts and alarms including the status of all incidents.

Describe the capabilities, functionality and visibility that DOCCS will have with your fault management offering and the functionality of your fault management solution.

SECURUS HAS READ, AGREES AND WILL COMPLY WITH THIS REQUIREMENT.

Securus provides highly reliable service from initial system design and installation through ongoing maintenance and support. Our service and maintenance program includes integrated

remote programming, diagnostics, downloading, and troubleshooting capabilities. Securus does not charge for maintenance, support, training, and repair of system software and equipment.

24x7x365 Service and Support

The SCP platform provides continuous online supervision and diagnostics — as well as offline system access — for advanced programming, diagnostics, troubleshooting, and call traffic analysis. Securus proactively identifies potential software, hardware and network abnormalities using the SolarWinds® suite of performance monitors along with custom developed machine data analysis software that provides operational intelligence. These monitoring and measurement tools provide insights that allow Securus personnel to monitor all hardware, software and network components continuously. The Securus service center personnel can also access the SCP advanced diagnostics and program control for failure reports, service history, and other diagnostic information.

This state of the art monitoring system has reporting and alarming capabilities that allows Securus to configure customized trigger conditions to send notifications to DOCCS in the form of Email notifications, SMS, SNMP Traps, File Logging, Syslog messaging, Script execution etc.

Network Operation Center

The Securus employees continuously monitor our Secure Calling Platform (SCP) from our Network Operations Center (NOC) headquartered in Dallas, Texas. The NOC is staffed 24x7x365 by network experts certified in the systems and software used to monitor all SCP functions and equipment, as well as the associated network. The NOC maintains failure reports, service history, and other diagnostic information, which are available to DOCCS when requested.

The SCP platform provides continuous online supervision and diagnostics — as well as offline system access — for advanced programming, diagnostics, troubleshooting, and call traffic analysis. The Securus service center personnel can access the SCP advanced diagnostics and program control for failure reports, service history, and other diagnostic information.

The NOC reports any actions required to prevent or repair any outages to each Securus employee supporting DOCCS. Securus will follow DOCCS protocols for communicating outages or repair actions in the unlikely event they occur.

Securus Network Operations Center in Dallas, TX



Premium Network Monitoring Capabilities

Securus proactively identifies potential system and network abnormalities through SolarWinds® suite of network performance monitors. This software allows Securus personnel to monitor all hardware, software and system metrics continuously.

Through network monitoring Securus can:

- **Proactively repair systems to prevent outages.** Many times corrections are made before a facility is aware of a problem. This means less downtime and increased system reliability for the facility.
- **Alert remote or on-site engineers of system threshold inconsistencies or alarms.** The NOC communicates with engineers through e-mail, short message service (SMS), or directly through a wireless phone to address the issue.
- **Receive real-time alerts when the system detects an error.** Monitoring identifies if network elements exceeded established thresholds and alerts Securus personnel of possible carrier network issues.
- **Ensure sufficient resources are in place.** The Securus capacity engineering team reviews call traffic volume reports and storage requirements throughout all systems to ensure sufficient network capacity.
- **Centrally monitor calling traffic to determine increases or decreases in the number of telephones.** With DOCCS agreement, the service and operations team will install additional telephones when required.

Remote Programming, Diagnostics, and Troubleshooting

The Securus NOC continuously monitors the SCP platform and our network. If the NOC observes a failure/trouble in any of the platform components, it can escalate the issue to the Technical Support Center (TSC) for resolving the issue. This action could involve dispatching a Field Services Technician to a DOCCS facility.

Technical Support Center

In 2009, Securus made a strategic decision to centralize management of all technical support. Today, Securus provides superior customer service capabilities from a state-of-the-art technical support center located in Dallas, Texas.

Approximately 50 technical professionals staff the Securus Technical Support Center (TSC) which handles approximately 8,000 inbound queries per month. The TSC provides a single-point-of-contact for Securus customers for issues ranging from minor maintenance issues to service outages. Clients can contact the TSC 24x7x365 by any of the following convenient methods:

- **Telephone** – 866-558-2323
- **E-Mail** – technicalsupport@securustech.net
- **Fax** – 800-368-3168
- **Web portal** - <http://www.securustech.net/facility/Default.asp>

The technical service center offers our clients:

- Technical support and field dispatch 24x7x365
- Fully trained staff of support professionals to answer calls
- Trained professionals to provide quick problem resolution and a higher level of customer service
- Service event tracking to drive resolutions
- Prioritized calls and analyzed reports to ensure achievement of Service Level Agreements
- Certified technicians to provide quick problem resolution
- System and individual site connectivity monitored 24x7x365

24x7x365 Securus Technical Support Center



Securus technicians receive internal Securus certifications, based on our business and the products and services we support.

Service Levels

When a facility calls Securus, an event tracking system assigns a trouble ticket, with one of three initial priority levels—P1, P2, or P3. Each level is designed to address specific system events and has a prescribed resolution timeline and escalation procedure. In all cases, Technical Support will respond to the customer within the required timeframe.

Priority 1 Service Level (DOCCS Levels 1 & 2)

A Priority 1 (P1) assignment—our highest priority assignment—occurs when a system event adversely affects 30 percent or more of system functionality. Examples of P1 service assignments include:

- Voice prompts not operating
- Features are not operating appropriately
- CD-burning abilities disabled
- Live call monitoring is not operating appropriately
- SCP access denied
- All phones out-of-service

The response time for a P1 event is two hours. If a dispatch is not required, Securus notifies the facility upon issue resolution. If a dispatch is required, Securus contacts the facility and provides an estimated time of arrival.

A P1 event escalates to:

- Technical Support Department
- Technical Support Manager
- Technical Support Director
- Regional Field Manager
- Executive Director of Service

If the problem resolution is delayed, escalation procedures within the Securus Management Team are activated to ensure appropriate resources are allocated to resolve the problem.

Priority 2 Service Level (DOCCS Levels 3 & 4)

A Priority 2 (P2) assignment—our mid-level priority assignment—occurs when a system event adversely affects 5 to 29 percent of system functionality. Examples of a P2 service assignment include problems or errors with related to:

- Workstation
- Specific system ports
- Local Exchange Carrier (LEC) circuits
- Unblocks
- Blocked numbers
- Missing call detail records (CDRs)
- Call searching

The response time for a P2 event is 24 hours. If a dispatch is not required, Securus notifies the facility upon issue resolution. If a dispatch is required, Securus contacts the facility and provides an estimated time of arrival.

P2 events escalate to the Technical Support Department.

Priority 3 Service Level (DOCCS Level 5)

A Priority 3 (P3) assignment—our lowest priority assignment—occurs when a system event adversely affects 5 percent or less of system functionality. System events adversely affecting some of available facility phones. Examples of P3 service assignments include:

- Static on the phone
- A party's inability to hear
- An inmate's inability to dial

- A broken phone
- Non-functioning dial pad
- Non-functioning cutoff switches
- An inability to generate reports

The response time for a P3 event is 72 hours. If a dispatch is not required, Securus notifies the facility upon issue resolution. If a dispatch is required, Securus contacts the facility and provides an estimated time of arrival.

P3 events escalate to the Technical Support Department.

Escalations

If a dispatch is not required, Securus notifies the facility upon issue resolution. If a dispatch is required, Securus contacts the facility and provides an estimated time of arrival.

The supervisory escalation chain is:

- Technical Support Department
- Technical Support Manager
- Technical Support Director
- Regional Field Manager
- VP Service and Technical Operations

Centralized Services Operations Model

All Securus services and operations are managed centrally, from our Service and Operations organization in Dallas, Texas. The Operations team's responsibility is supporting external customers, including Customer Service, Field Services, Installation and Engineering, and Technical Support. The Support Services team provides internal support services including Quality, Training and Customer Satisfaction, and Reporting and Analysis.

The following figure illustrates the Securus Service and Operations organization, which is staffed by full-time Securus employees.

Services and Operations Organization

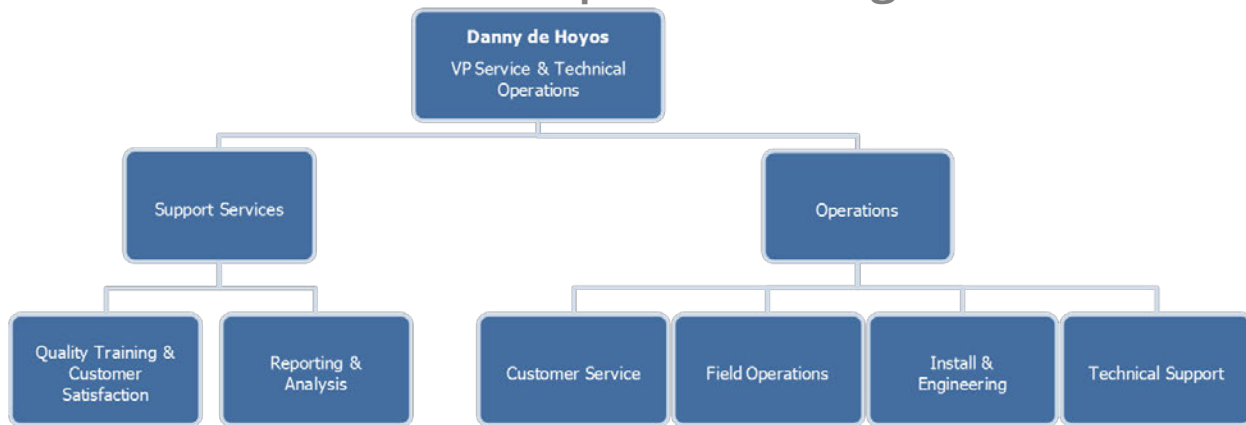

Securus adopted this operational model because of the natural interaction between functional groups. Having our support services integrated and centrally managed enables cross-functional group interaction, improving the response time, and efficiencies of our services.

Call Routing

The TSC manages the flow of inbound calls through a call distribution system that routes calls directly to our support technicians in a skills-based, platform specific manner. Securus establishes response times and service level agreements that accomplish our key objective of providing timely resolution to each request. Service calls are answered 24x7x365 by live technicians to provide timely and quality customer service.

Trouble Ticketing Process

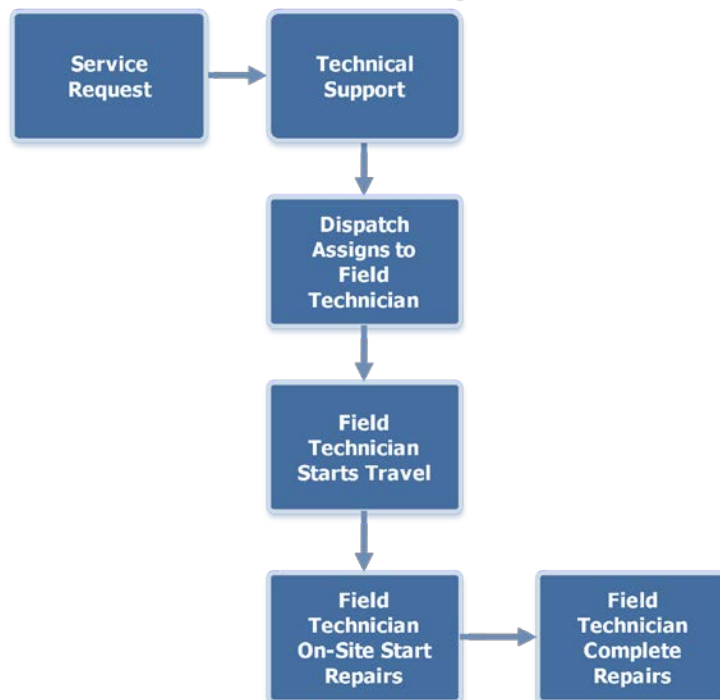

In all instances, service will be requested through the TSC and field service personnel will be dispatched through trouble ticketing system to ensure documentation and timely resolution of all service tickets.

Event Tracking System

The Securus event tracking system logs, tracks, manages, and assures an appropriate response to all service requests. The service request generates a unique trouble ticket number linked to each facility's service history and provides real-time updates. Each ticket has a priority level assignment, which drives diagnosis and response processes. The support technician performs initial problem diagnosis and isolation procedures, determines the nature of the problem, and resolves the problem or engages the appropriate party for problem resolution.

The TSC maintains ownership of all service requests and responsibility for the escalation and update functions. Every effort is made to resolve problems remotely and within the framework of resolution timeframes. However, if the problem requires on-site service, a technician is dispatched. Securus will contact the facility to arrange for the on-site service at the convenience of the facility.

DOCCS facilities can also open and track trouble tickets through our convenient facility portal.

Facility Portal

Securus provides customer facilities with one of the only anywhere, anytime, single-point-of-access customer portals in the industry. Approved & authenticated users can access all calling activity, including all call detail reports. The Facility Portal also serves as the user interface to the Securus electronic trouble ticket system. Authorized users can initiate trouble tickets for repairs, track the real-time ticket status, and generate current and historical reports of trouble tickets with the Facility Portal. The facility Portal generates a tracking number for each ticket opened. Users can search for service tickets by ticket number or by date search. All updates are sent electronically in real-time to the originator of the ticket, as well as to DOCCS designee.

Open Service Ticket

FRIENDS & FAMILY **CORRECTIONAL FACILITIES** ABOUT US CAREERS CONTACT US

Facility Portal

Facility Name

Dashboard
Portal Manager
Commissions Reports
General Reports
Order Materials
Downloads & User Guide
Service Center
Your Tickets
Create A Ticket
Date Search

Search Tickets

Create Service Ticket

Site: Facility Name

Problem Category: Please Choose a Category

Suggested Priority: Please Choose a Category

Problem Description: Full Outage
Inmate Can't Place Call
Other
Partial Outage
Password Reset
Phone/Equipment Replacement
PIN Reset
SCP User Interface Question

Submit Ticket

Manage Your Service Tickets

FRIENDS & FAMILY **CORRECTIONAL FACILITIES** ABOUT US CAREERS CONTACT US

Facility Portal

Facility Name

Dashboard
Portal Manager
Commissions Reports
General Reports
Order Materials
Downloads & User Guide
Service Center
Your Tickets
Create A Ticket
Date Search

Search Tickets

Help
Secure Call Platform
Log-Out

Your Service Tickets

SITE NAME	TICKET #	DESCRIPTION	LAST UPDATED	STATUS
Facility Name	13802690	Div 11 VB enrollments	2011-08-16 09:56:04	Closed
Facility Name	13799269	Voice Biometrics - the customer is enrolling/re-enrolling inmates in VB at Division 11...	2011-08-12 11:06:10	Closed
Facility Name	13792501	Report Request: Calls completed in 2008 from Division 1, Tier B-4 Call period is 9/1...	2011-08-05 15:19:43	Closed
Facility Name	13783054	customer reports that he creates an iso image to burn to DVD and when image was downlo...	2011-07-29 10:24:54	Closed
Facility Name	13782536	Voice Biometric - Re-enrollments the customer is doing re-enrollments of inmates at t...	2011-07-28 11:10:58	Closed

1234
Total Tickets

Clicking the ticket number in the service history generates a report with ticket detail. Users can review all the notes and the final resolution of any closed ticket at any time. If the ticket is currently open, users can create a new journal note. Consent to close a ticket can also be performed using the notes section.

Example of ticket detail:

Ticket Detail

The screenshot shows the Facility Portal interface. At the top, there is a navigation bar with links for 'FRIENDS & FAMILY', 'CORRECTIONAL FACILITIES', 'ABOUT US', 'CAREERS', and 'CONTACT US'. Below this is the 'Facility Portal' logo. On the left, a sidebar under the 'Marketing' heading contains links for Dashboard, Portal Manager, Reports, Order Materials, Downloads & User Guide, Service Center, Your Tickets, Create A Ticket, Date Search, Search Tickets, S-Gate, and Log-Out. The main content area is titled 'Ticket Details #13529104'. It features a 'TICKET #13529104' section with the following details: Call Description: female pod 11 block phone not working; Ticket Priority: 3; Ticket Status: Closed; Date Opened: 12/20/2010 8:14:24 AM; Last Update: 12/20/2010 8:51:24 AM; Solution Description: reset sips. Below this is a 'JOURNAL NOTE ENTRIES' table with two entries:

Location	Date/Time	Description
Igreathouse	12/20/2010 8:40:03 AM	Issue Resolved - waiting for Customer Approval
Igreathouse	12/20/2010 8:39:53 AM	Authorization Obtained from: Hogan

At the bottom of the ticket details section, there is a button labeled 'Create A New Journal Note'.

Facility Portal Reports

DOCCS users can view or download several reports from the Facility Portal:

- **Calling Activity Report** – This report provides details on the number and type of calls made from a telephone number at the facility.
- **Call Type Summary Report** – This report provides details on the number and type of calls made from a specific telephone number at the facility. Calls will be broken down by local, intraLATA, interLATA and interstate.
- **Daily Call Volume Snapshot** – This report shows a daily snapshot of calls and minutes compared to the daily average
- **Monthly Call Frequency Chart** – This chart details the most frequently called numbers from the facility.
- **Preliminary Monthly Revenue Report** – This report details all calls, minutes and revenue for a specific date range.
- **Preliminary Daily Revenue** – This report details all calls, minutes, and revenue for a specific date.

- **Investigation Tool** – This tool allows for tracking of a specific dialed number from any of the approximately 2,600 facilities serviced by Securus.

The Securus Field Services Team

The Securus Field Services organization is one of the largest in the inmate phone system industry. Our team consists of approximately 150 Field Service Technicians (FSTs) located throughout the United States, including a team to support the systems in New York. Our teams have expanded based on our growing customer needs.

Our field services team installs and maintains inmate phone systems for approximately 2,600 facilities and a million inmates in 47 states. The Securus Field Operations Director manages three Regional Service Managers who possess more than 60 years of combined field service experience.

Field Service Technicians

Securus requires that all FSTs have an extensive telecommunications background and tests each applicant before employment. Additionally, FSTs receive extensive Securus training and certifications to support our product offerings.

FSTs respond to critical issues within four hours (or less if required by specific DOCCS requirements). The technician is required to follow a structured technical and management escalation process if they are unable to isolate the problem within four hours. Our integrated support model keeps our centralized technical support team engaged through problem resolution. FSTs and the technical support team have direct access to product and development engineers, enabling them to expedite repairs and minimize customer downtime.

Securus field service technicians maintain a working level of spare parts for minor repairs consisting of telephone sets, handsets, dials, and replacement circuit boards, either on-site or in their truck. If a technician does not have a required part, Securus will drop-ship the item to the site. Securus will ship counter-to-counter on the same day in critical situations.

Field Service Manager

In addition to FSTs, Securus customers are supported by field service managers who:

- Conduct remote visits via phone bimonthly. Based on information obtained from call, a trouble ticket may be opened
- Work with the account team quarterly to evaluate contract progress with DOCCS
- Provide the facility with applicable site information that assists them based on the account profile
- Monitor ticket traffic
- Resolve escalation issues, as needed.

Each field service manager possesses the skills required to perform the duties of the field service technician and can provide additional or backup support as needed.

Customized Alert Notifications

The Network Operations Center continuously monitors your hardware, software, and network performance. This allows our dedicated personnel to diagnose and resolve issues on your system, often before the customer notices a problem. Securus proactively identifies potential system and network abnormalities through our centralized diagnostic application Orion by Solar Winds. This tool allows us to isolate network issues down to the port level at the equipment located at DOCCS facilities. All performance issues are logged and will be provided to DOCCS in a variety of media. DOCCS will be notified via a splash-screen in SCP, incident notification via e-mail to the specified DOCCS e-mail address, and in DOCCS monthly maintenance report.

Securus has the ability to create an unlimited number of alerting conditions based on all elements we are proactively monitoring, as shown in the following figure.

Alert Conditions

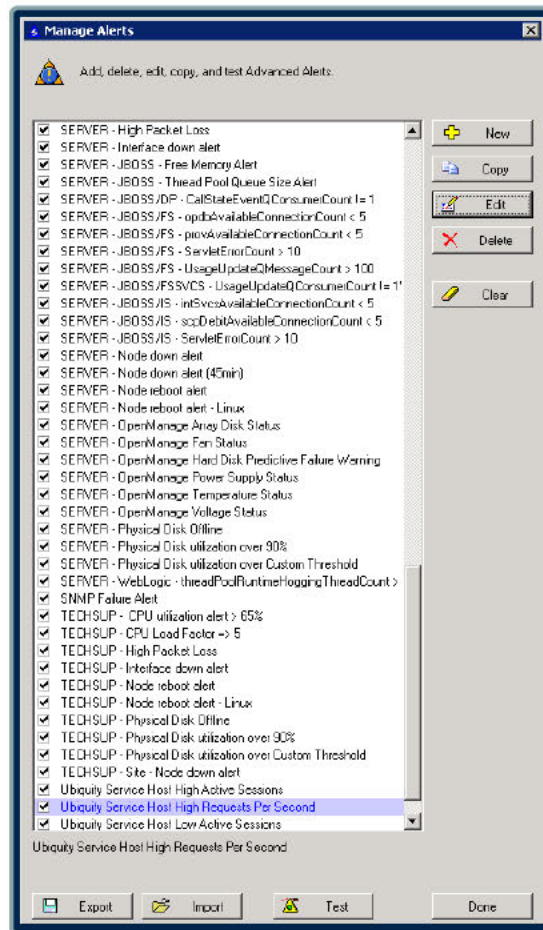

Each alert is highly customizable, as shown in the following image. **Any alert alarm received from the SCP user interface can be printed for easier viewing.**

Alert Settings

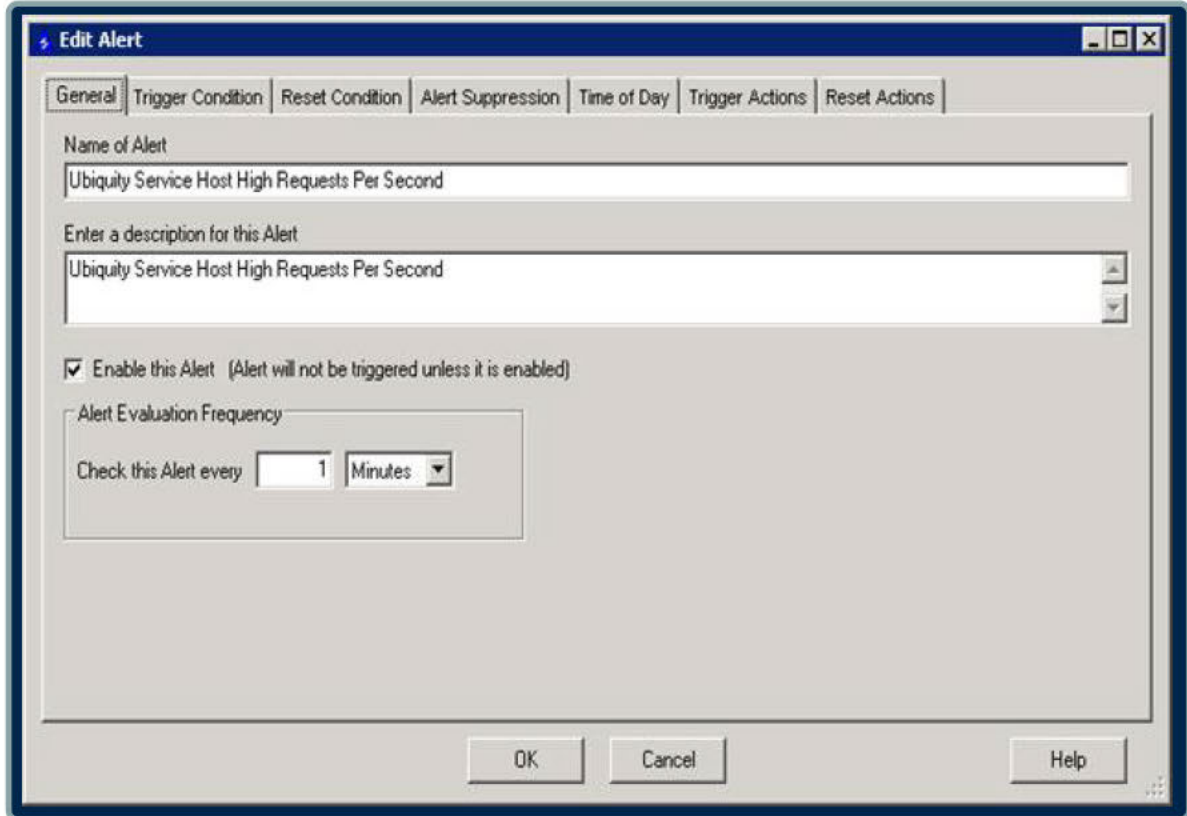

We can define the alerting criteria using an unlimited number of conditions, allowing fine tuning along the lines of a single component or a global rule set (such as any disk over 90% utilization), as shown in the following figure.

Alert Trigger Conditions

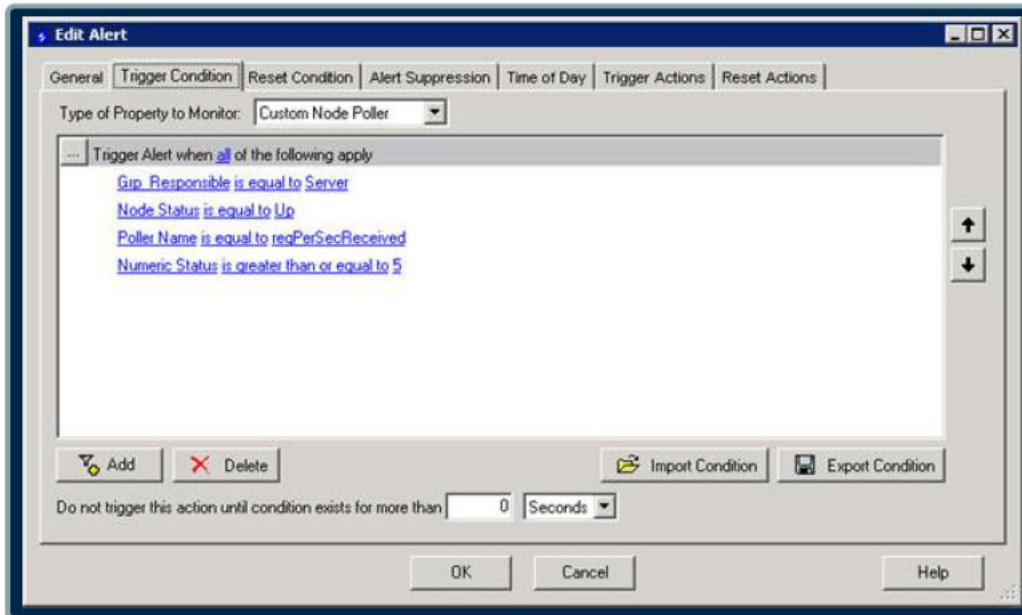

When the condition is met, we have the option to trigger an unlimited number of alarms, including Orion Event Logging, Email notifications, SNMP Traps, File Logging, Syslog messaging, program/script execution, and SMS. This also includes Time Delayed Escalation alerts if the alarming criteria have not cleared in a specified amount of time. This option is shown in the following figure.

Alert Trigger Actions

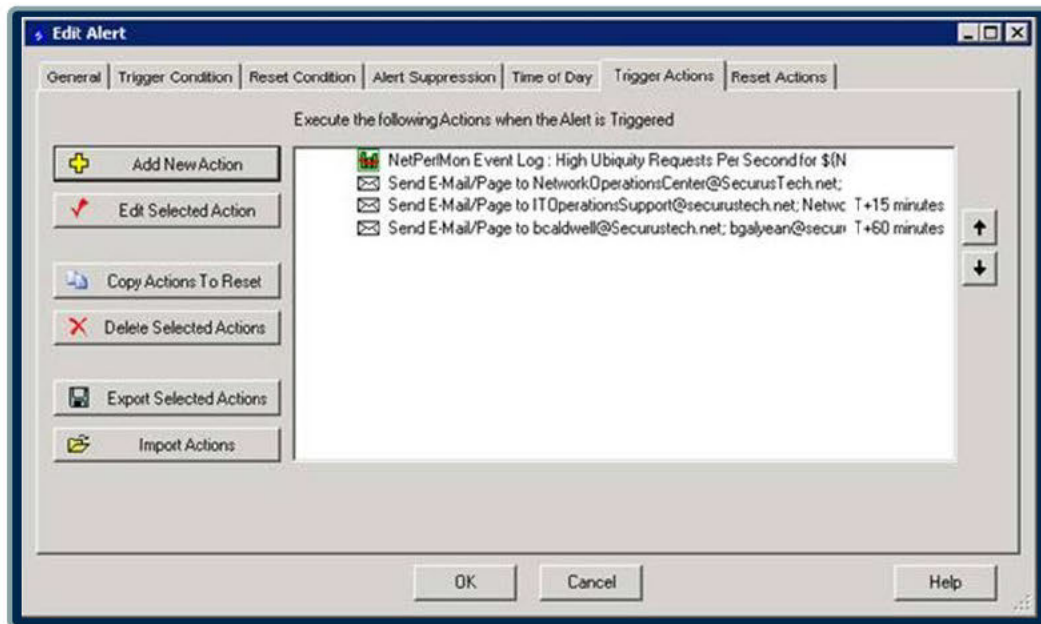

3.2.2 Configuration Management

The vendor must provide configuration management capabilities that include the provisioning of devices, systems administration, gathering and storing of configuration data, managing version control, tracking and scheduling of changes, and the assignment of permissions to access system investigative features. Access to all system functions will be restricted to users authorized by DOCCS. Each authorized user must have a unique user-ID and password.

Describe the functionality of your configuration management solution, including the capabilities and functionality that DOCCS will have with your offering.

SECURUS HAS READ, AGREES AND WILL COMPLY WITH THIS REQUIREMENT.

Securus will maintain a history report of each system change, which will include date and time of the change, facilities affected, changes implemented, testing complete date and date of change accepted by DOCCS.

Securus' Change Control Process is the responsibility of our internal Change Control Board (CCB) spearheaded by the IT Change Control Board Coordinator. All changes are requested by opening an Engineering Change Request using an automated system. The following steps are then followed to ensure the requested change, if approved, is properly implemented. These steps also apply to configuration management of feature functionality, version control, and access to system investigative features specific to DOCCS.

Record/Classify

A change is only initiated as a result of a formal request for something to be changed. The change control team then records and categorizes that request. This categorization would include estimates of importance, impact, and complexity.

Assess

An impact assessor or assessors are assigned to analyze the level of risk associated with the change by answering a set of questions concerning risk, both to the business and to the process, and follow this by making a judgment on who should carry out the change. If the change requires more than one type of assessment, the head of the change control team will consolidate these. Everyone with a stake in the change will meet to determine whether there is a business or technical justification for the change. The change is then sent to the delivery team for planning.

Plan

The Securus Change Control Board Coordinator will assign the change to a specific delivery team, usually one with the specific role of carrying out this particular type of change. The team's first job is to plan the change in detail as well as construct a regression plan in case the change needs to be backed out.

Build/Test

If all stakeholders agree with the plan, the delivery team will build the solution, which will then be tested. They will then seek approval and request a time and date to carry out the implementation phase.

Implement

Changes effecting service at customer's facilities are scheduled to only take place when the inmate calling systems are not generally in use, usually between 1:00 AM and 6:00 AM, Central Time. All stakeholders must agree to a time, date, and benefits of implementation. Following implementation, a post-implementation review takes place to review the quality of change implementation, best practices and to adjust implementation procedures for future changes if required.

Close/Gain Acceptance

When all stakeholders agree that the change was implemented correctly, the Engineering Change Request is officially closed.

The Securus Secure Call Platform (SCP) provides an advanced, multi-level password scheme specifically designed to provide facility administrators the ability to assign unique levels of access to anyone using the different features of the SCP. There are view and change options for each module depending on the need of the user.

Manage, Create, Edit, Predefine User Levels in SCP

The screenshot displays the 'Security Templates' management interface. At the top, there is a navigation menu with 'HOME', 'SYSTEM', 'MONITOR', 'TOOLS', 'ADMIN', and 'FACILITY PORTAL'. Below the menu, the 'MANAGEMENT LEVEL' is set to 'Facility' and the facility is 'Securus Demo Site'. A callout box states: 'Administrators can manage, review, edit, and delete all security templates, predefine templates, and add new templates as required - all from one location in SCP.' The main content area shows a table of security templates with columns for 'NAME', 'DESCRIPTION', and 'PREDEFINED'. The table lists various templates such as '3rd Shift - blocking only', '5.0 Huong test', '5.0.1 Add Template', '5.1Huong Test', 'ADC-test1', 'ALL BUT NO 3 way', 'ALL BUT NO FREE', 'Adam All', and several 'Admin -' templates. The 'Admin -' templates have checkmarks in the 'PREDEFINED' column.

NAME	DESCRIPTION	PREDEFINED
3rd Shift - blocking only	Night jailers can block number but no changes otherwise	
5.0 Huong test	Huong test	
5.0.1 Add Template	Huong Test	
5.1Huong Test	Huong test	
ADC-test1	This is for the demonstration	
ALL BUT NO 3 way	ALL permissions but no 3 way	
ALL BUT NO FREE	All but free	
Adam All	Everything	
Admin - Crime Tip Modify	Crime Tip Modify Access Admin	✓
Admin - Crime Tip Read	Crime Tip Read Access Admin	✓
Admin - Informant Line Modify	Informant Line Modify Access Admin	✓
Admin - Informant Line Read	Informant Line Read Access Admin	✓
Admin - No Monitor	Administrator w/o Live Monitoring Rights	✓

The administrator may modify the initial access levels or create additional levels based on facility clearance objectives for each tool. SCP generates a user log with the user name, time of access, and modules accessed.

Create New Security Templates

Administrators can create new security templates based on unique requirements.

CONTROLLED AREA	CAN VIEW	CAN CHANGE
Admin - Security Templates	<input type="checkbox"/>	<input type="checkbox"/>
Admin - User Management	<input type="checkbox"/>	<input type="checkbox"/>

Additional Password Policy Options

SCP provides flexible Password Policy options, enabling administrators to customize login security to meet their needs. Passwords can be configured by location, length, days to expire, and even the number of password cycles before password reuse. Additional configuration options include reminders for password expiration and minutes of allowable inactivity before session timeout.

If a user does not change their password before expiration, the user must contact the site administrator for password reset. This administrator assigns a random password and requires the user to create a new password when they log in.

Password Configuration Options in SCP

Passwords can be customized in length, duration, recurrence and more.

The “Forgot Your Password” feature available from the login screen offers online support for users who have forgotten their password. System security requires users to provide the correct answers to preset questions before their password can be reset. Once a new password is created, SCP emails confirmation to the address linked to the user ID.

3.2.2.1 Provisioning and Active Directory

DOCCS provisions authorized users and applies permissions to investigative and control features on a case-by-case basis. The State’s goal is to automate provisioning using role-based access stored within the State’s Active Directory structure.

Describe how Active Directory may be leveraged to automate this function within your solution.

SECURUS HAS READ, AGREES AND WILL COMPLY WITH THIS REQUIREMENT.

Our customer facing applications use a combination of Microsoft Active Directory and Databases for authorization and authentication controls. This combination of technologies helps us ensure secure authentication practices in our environment for customer peace of mind. Securus employs strong access control policies and controls based on the NIST guidelines to prevent unauthorized data access. Securus enforces the practice of separation of duties and the concept of least privilege. Since our infrastructure is a self-contained and secure environment, integration will not be possible as we do not allow external entities to interface with our Active Directory structure, nor does it support SSO (single sign-on).

Securus takes the security and access to our software/application very seriously and hence have implemented one of the strongest controls in the industry. Access to business information systems is provided based on the job functions of each employee using the principle of least privilege. When an individual requires elevated entitlements, a request is submitted to the Information Security Office for review. Once the business owner (or approved delegate) approves the request, the elevated access is granted either by creating a new account or by modifying a current account. The access is then communicated to the end user and tracked by the Information Security Office. Securus access controls for all systems are audited for compliancy with the following accreditations/certification:

- SSAE16; (SOC1, SAS70): Statement on Standards for Attestation Engagements (SSAE) No. 16, Reporting on Controls at a Service Organization
- PCI: The security standards are developed by the Payment Card Industry Security Standards Council
- SOX: The Sarbanes–Oxley Act of 2002, is a United States federal law that set new or enhanced standards for all U.S. public company boards, management and public accounting firms.

The applicability and adherence to access policies are applied across all systems with regular frequency control (Daily, Weekly, Quarterly, Semi-annual, and Annual) and overall Security protocol process flow is audited on a yearly basis.

3.2.3 Accounting Management

The vendor must provide accounting management capabilities that at a minimum provide account verification and correction, billing assurance and reconciliation and tracing of customer payment, credit and call limit/blocking status and history. On a monthly basis, the vendor must provide a billing reconciliation file to DOCCS as described in Attachment D.

Describe the functionality of your solution, including the capabilities and functionality that DOCCS will have with your offering.

SECURUS HAS READ, AGREES AND WILL COMPLY WITH THIS REQUIREMENT.

Securus provides its customers with a fully featured and functional customer account management suite of services. The management of customer accounts is a vital component of our commitment to complete more telephone calls than other vendors. Our 250+ seat customer service center, located in Dallas, Texas, is staffed by highly trained associates that handle all account verification and corrections as well as billing assurance and reconciliation. Through these associates, Securus handles thousands of customer interactions per day, including tracing of customer payment, credit, call limit/blocking and history. Securus commits to bring our extensive experience in this area to handle DOCCS account and will provide the required monthly reports and billing reconciliation as described in Attachment D, within the legal and regulatory parameters that govern Customer privacy.

DOCCS will benefit from Securus' certifications as to the accuracy, security, and control processes that have been validated by third-party experts. Securus complies with all of the accounting management and billing assurance requirements outlined above.

Securus Online

Inmate friends and family members can manage all phone services, video visitation services, and email services from www.secrusutech.net/friends or www.securustechnologies.com.

Securus Online



SECURUS
Technologies

Email Address
Type your email address

Password

Remember Me

[Login Assistance](#) [Enroll Now](#)

[Home](#) | [Phone Services](#) | [Video Services](#) | [Jail Voicemail](#) | [Money Transfer](#) | [Email Services](#) | [Facilities We Serve](#) | [FCC](#) | [Customer Care](#) | [Live Chat](#)



Welcome to
SECURUS TECHNOLOGIES
connecting what matters™

[Get Started Now!](#)

Receive a call today!

Open a prepaid AdvanceConnect™ account today and begin receiving calls immediately.

[Learn More](#)

Visit an inmate from home!

Save time and money by visiting your incarcerated family and friends from the comfort of your home or office.

[Learn More](#)

State to State Rates Remain in Effect

FCC State to State Calling Rates (\$0.25 and \$0.21 per minute rates) remain in effect

[More information](#)

Watch how Securus Video Visitation Keeps Families Connected

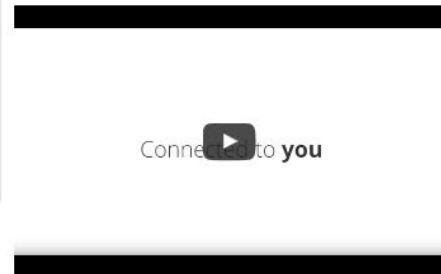

Apple, the Apple logo, iPhone, and iPad are trademarks of Apple Inc., registered in the U.S. and other countries. App Store is a service mark of Apple Inc.
Android, Google Play and the Google Play logo are trademarks of Google Inc.

Account Verification and Correction

Account Alerts [Privacy Policy](#) | [Mobile Terms and Conditions](#)

Account Selection

Select an account to set up alerts:

Enter USA Mobile Phone Number

Enter a mobile phone number to receive account and payment text alerts:

Do not enter spaces or dashes
You will receive 5 messages per month. Message and data rates may apply.

Alert Selection

Email Text

Yes, I would like to receive a Low Balance alert for my AdvanceConnect.

Once you save your settings you will receive a message confirming your subscription.

Click [here](#) for Mobile Terms and Conditions and click [here](#) for our Privacy Policy.
Text STOP to 77929 opt out at any time, or text HELP to 77929 get help.

Billing Assurance and Reconciliation



My Account | Phone Services | Video Services | Securus Alerts | My Settings | Customer Care | Securus Home



Phone Services

**ADVANCE
CONNECT**

Phone Number: (972) 922-8823
Account Number: 12454515
Available Funds: **\$0.00**

ADD FUNDS

- Manage Account ▶
- Call Details ▶
- Transaction Details ▶
- BLOCK & UNBLOCK CALL ▶

Account Status:

Account Relation: Owner

Want to ensure you always have funds?

Sign up for AutoPay or TextPay by clicking [here](#).

Customer Payment and Credit

Enroll In Securus Online

- 1 Email Address
- 2 Account Information**
- 3 Facility Selection
- 4 Service Selection

Account Holder Information

Please complete the information below as it appears on your ID.

First Name: Last Name:

Email Address:

Country:

Phone Number:

Address:

City: State: Zipcode:

Create a 4-Digit Passcode

Your 4-Digit Passcode is specific to your account and will be used for identification and security purposes whenever you contact our Customer Care team.

4-Digit Passcode:

Confirm 4-Digit Passcode:

Verification

Enter the number below:

[Refresh](#)

BACK

RESET

NEXT

Enroll Below in AutoPay or TextPay

Account Selection

Select an account to set up alerts:

Advance Connect - 12454515 

AutoPay

Ensure you never miss a call with AutoPay, sign up today!

AutoPay automatically funds your AdvanceConnect account with a preset amount of your choice whenever your account reaches a balance of \$10.00.

AutoPay Notification Options

Text Email

By submitting your credit card information you are giving permission to Securus Technologies to charge your credit card for AutoPay. Transaction fees up to \$3.00 may apply. You can unsubscribe from the service at any time by logging into Securus Online and choosing "Manage Account". If subscribing to text alerts you will receive up to 5 messages per month. Message and data rates may apply.

Enroll Below in AutoPay or TextPay

Account Selection

Select an account to set up alerts:

Advance Connect - 12454515 

AutoPay

Ensure you never miss a call with AutoPay, sign up today!

AutoPay automatically funds your AdvanceConnect account with a preset amount of your choice whenever your account reaches a balance of \$10.00.

TextPay

Ensure you are always connected with TextPay, sign up today!

TextPay will send you a text message when your account balance reaches \$10.00. You can simply reply to the text to immediately fund with your preset amount. If you dont reply no funding will take place.

TextPay Notification Options

Text

By submitting your credit card information you are giving permission to Securus Technologies to charge your credit card every time you authorize a TextPay payment from your mobile phone. Transaction fees up to \$3.00 may apply. You can unsubscribe from the service at any time by logging into Securus Online and choosing 'Manage Account' or by replying STOP to any TextPay alerts. If subscribing to text alerts you will receive up to 5 messages per month. Message and data rates may apply.

Call Limit / Blocking Status and History

Facility Selection

- 1 Email Address
- 2 Account Information
- 3 Facility Selection**
- 4 Service Selection

Please select the state of the Correctional Facility where the Inmate is housed.

State:

Please select the Correctional Facility where the Inmate is housed.

If you cannot find a facility in the list, please review the list of [Facilities We Serve](#).

Facility ID	Facility Name	City	Address
08242	BENEWAH COUNTY JAIL	ST. MARIES	701 COLLEGE AVE
00588	CUSTER COUNTY JAIL	CHALLIS	130 S 8TH ST
00209	IDAHO COUNTY JAIL	GRANGEVILLE	320 W MAIN ST
05885	NEZ PERCE COUNTY JAIL	LEWISTON	1150 WALL ST
04998	VALLEY COUNTY JAIL	CASCADE	107 W SPRING ST

BACK

SECURUS Technologies

My Account | Phone Services | Video Services | Securus Alerts | My Settings | Customer Care | Securus Home

Securus Video Visitation allows you to visit from ANYWHERE!!
Download the Securus Video Visit App Today!

Available on Google Play | Download on the App Store

Phone Services

ADVANCE CONNECT

Phone Number: (972) 922-8823
 Account Number: 12454515
 Available Funds: **\$0.00**

ADD FUNDS

Manage Account ▾
 Call Details ▶
 Transaction Details ▶
 Block & Unblock Calls ▶

Account Status:
 Account Relation: Owner
 Want to ensure you always have funds?
 Sign up for AutoPay or TextPay by clicking [here](#).

Manage Account

Authorized Phone Numbers [Edit](#)
 Securus Alerts [Edit](#)
 Account Statement [Download](#)
 AutoPay/TextPay Enrollment [Enroll](#)
[Close Account](#)

All Apple and Android smart phones and tablet devices can access Securus Online. Securus has optimized our online experience for mobile devices. Users can make payments and view transaction histories as well as sign up for new services; features not available from other inmate telephone service providers.

Securus sends low balance AdvanceConnect account notifications via text to a mobile device or an email address provided by the user. Securus also sends direct bill invoice due notifications via text or email.

Securus also has outgoing message phone dialers for “low balance” and “invoice due” notifications. When they receive one of these calls, users can either fund an account or pay their bill via our interactive voice response system. If an account has been blocked because funds are low, or a bill is due, users can unblock their account through this convenient payment method. Users can also access Securus Online to pay bills and fund accounts.

3.2.3.1 Third Party Auditing

DOCCS or its agent shall have the right to audit and review any aspects of the contractor's operations and systems including but not limited to data, documentation, procedures, billing, financial records, customer service statistics, staff backgrounds and anything related to the functioning, operations, costs, rates or integrity of the system.

SECURUS HAS READ, AGREES AND WILL COMPLY WITH THIS REQUIREMENT.

3.2.3.2 Call Detail Records (CDR)

The vendor must provide all call detail records to DOCCS in a frequency and format as specified in Attachment D.

SECURUS HAS READ, AGREES AND WILL COMPLY WITH THIS REQUIREMENT.

3.2.4 Performance Management

The vendor's solution must provide performance management capabilities to monitor the overall performance of the ITS and its network components.

Describe all of the following:

- How you will collect and analyze performance data, monitor system health and reliability, establish performance thresholds and provide reporting and inquiry functions.

SECURUS HAS READ, AGREES AND WILL COMPLY WITH THIS REQUIREMENT.

Securus continuously monitors all data centers, infrastructure components, platform systems and Inmate Telephone Systems (ITS) using the SolarWinds® suite of network performance monitors. The SolarWinds® performance monitors are highly configurable to provide real-time monitoring, event notification, alert history and statistical information. An alarm condition creates immediate visual alerts and email notifications.

Network Operations Center (NOC)

The Securus Network Operations Center (NOC) provides 24x7x365 monitoring for all Securus systems, including SCP, network, back-office systems and data centers. The NOC proactively monitors these systems to ensure performance is optimal and uninterrupted. In addition to system and network level monitoring, the NOC also monitors real-time video surveillance and environmental alerts for our data centers. Securus maintains a fully redundant backup NOC at a separate physical location, should services be disrupted at the primary location.

SolarWinds® Typical Monitored System & Application Elements

CPU and memory monitoring to alert the NOC if pre-determined thresholds are exceeded. Thresholds are typically 90% for CPU and 80% for memory.

Active system and application alerts - All alerts are monitored by the NOC visually and via email notification.

Application and component health monitoring. All application alerts are ticketed and addressed by the NOC or routed to the appropriate engineer for resolution.

Hard drives monitored for status and capacity. The NOC will receive an alert if a disk becomes degraded or reaches 90% capacity.

Availability statistics are tracked and ensure expected performance of systems.

Active Alerts (0)

ALERT NAME	MESSAGE	TRIGGERING OBJECT	ACTIVE TIME	RELATED NODE
ssh Port Monitor		TCP Port Monitor	Up	
syslogd		SNMP Monitor	Up	
Number of Processes		SNMP Monitor	Up	
Configured MaxFiles		SNMP Monitor	Up	
Number of Users		SNMP Monitor	Up	
Number of Running Processes		SNMP Monitor	Up	
Linux Uptime (seconds)		SNMP Monitor	Up	
rsync process		SNMP Monitor	Up	
rsync config		SNMP Monitor	Up	
auditd process		Process Monitor	Up	
crond process		Process Monitor	Up	
DNS Config		SNMP Monitor	Up	
Inodes % Used		SNMP Monitor	Up	

Processes and Services

Component Name	Process Name (PID)	CPU Load	Physical	Virtual	Open
auditd process	auditd (15378)	0	0	0	N/A
crond process	crond (4241)	0	0	0	N/A

Components

Component Name	Statistic	Message	Response Time	Port
Configured MaxFiles	19461 M		0 ms	N/A
DNS Config	0		0 ms	N/A
Inodes % Used	10		0 ms	N/A
Linux Uptime (seconds)	6,111 M		0 ms	N/A

Application Health Overview

Application Count: 11

- 11 Up
- 0 Critical
- 0 Warning
- 0 Down
- 0 Unknown
- 0 Other

Premise Equipment

The Securus Technical Support team provides 24x7x365 monitoring of all facility-based equipment and directly supports facility installations via telephone and email. Technical Support monitors connectivity for all installations and all installed equipment including Integrated Access Devices (IADs), Visitation Phone Monitoring (VPM) units, switches and Uninterrupted Power Supply (UPS) systems. The systems are polled every two minutes to ensure and their vital operating statistics sent every 10 minutes. Upon receiving an alert indicating network failure, Securus will open a trouble ticket with the appropriate circuit provider. In the case of a premise-based equipment failure, a Securus Field Technician is dispatched to the facility for on-site repair.

SolarWinds® Device Monitoring Example

Premise equipment alerts - All alerts are monitored by the Technical Support group visually and via email notification. All alerts are ticketed and addressed by the Technical Support group or are routed to the appropriate engineer for resolution.

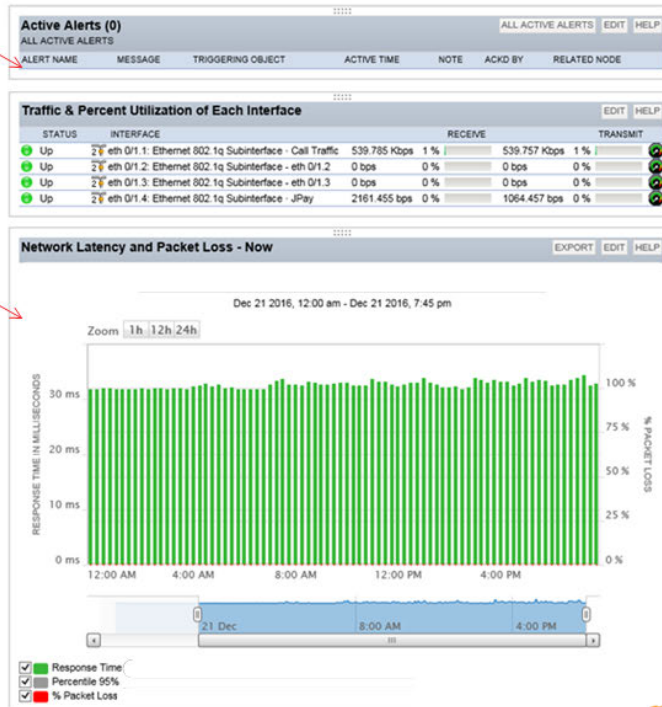

Premise equipment interfaces are monitored for bandwidth utilization and capacity management.

Connectivity, response times and packet loss are constantly monitored. All premise equipment is polled every two minutes.

In addition to real-time monitoring and alerting, Securus Technical Support also leverages the SolarWinds® network performance monitor to gather and evaluate historical data for network alerts, bandwidth usage, and packet loss and hardware performance. The detailed level of monitoring available via our network performance monitor allows the Technical Support group to take proactive steps to prevent or mitigate facility outages and to ensure the correct resources are engaged if dispatch is necessary.

Infrastructure Inspections

System Administrators make scheduled inspections of all systems and routinely perform preventive maintenance and software enhancements as directed by a Production Change Control steering group. Additionally, change control practices have been reviewed and are compliant with Sarbanes-Oxley.

Securus Calling Platform Provisioning Standards

All Securus calling platforms interface with industry standard analog and digital provisioned telephony circuits, such as the following services:

- POTS (plain old telephone service)
- ISDN (Integrated Services Digital Network)

- PRI (Primary Rate Interface)
- DS-1/T-1 (Digital signal 1, also known as T1)
- DS-3 (Digital Signal 3)

The PRIs (Primary Rate Interfaces) provide detailed information for advanced call routing and call progression and enforce outgoing service for our legacy platforms. Our centralized, packet-based platform, called Secure Call Platform (SCP) uses MPLS (Multiprotocol Label Switching) circuits, DSL (Digital Subscriber Line), and POTS lines.

The following are a few examples of the NOC monitoring views:

NOC-Monitoring View

The screenshot displays a comprehensive NOC monitoring dashboard. A red callout box on the left points to the 'Average Response Time & Packet Loss' section, stating: "Expanded NOC view with alert, connectivity and device details." This section features two gauges: 'Avg Resp Time' at 38 ms and 'Packet Loss' at 0%. Below this are sections for 'All IP Addresses on 06435_tdcj_allred_mps_scp_adtran924_1_tx', 'Management' tools, and 'Node Details' for a specific node. The 'Node Details' section shows the node is up, with polling IP 10.144.37.1, machine type 'Adtran TotalAccess 904', and system name 'Total Access 904 (2nd Gen)'. The right side of the dashboard includes 'Active Alerts (0)', 'Traffic & Percent Utilization of Each Interface' (showing 'Up' status with 3970645 bps receive and 0 bps transmit), 'Disk Volumes', and a 'Network Latency and Packet Loss - Now' chart. The chart shows response time in milliseconds (left axis, 0-60) and packet loss percentage (right axis, 0-100) over a 24-hour period from Dec 21, 2016, 12:00 am to 8:20 pm. A legend indicates that green bars represent 'Response Time' and red bars represent '% Packet Loss'. The 'Last 5 Notes (0)' section is at the bottom right.

Additional NOC-Monitoring View

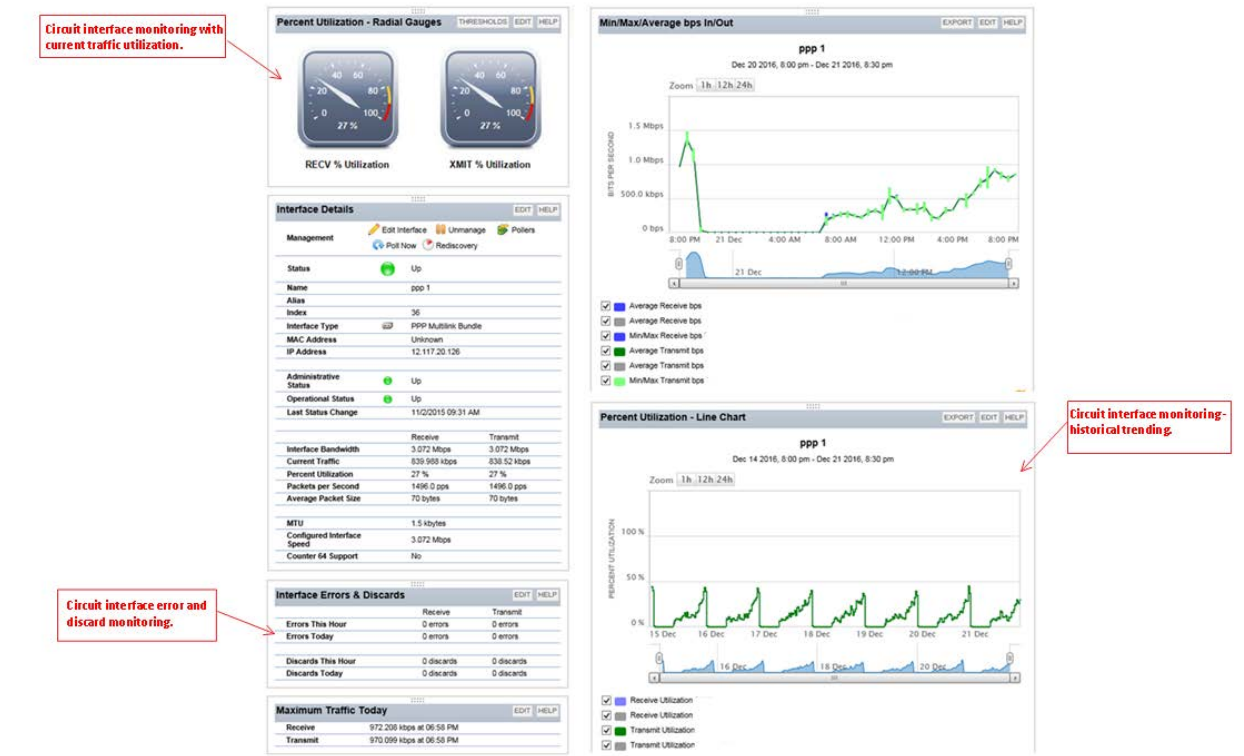

- The capabilities and functionality that DOCCS will have with your offering.

SECURUS HAS READ, AGREES AND WILL COMPLY WITH THIS REQUIREMENT.

See Section REQUESTED DOCUMENTATION (page 531)

DOCCS will have many performance management tools and capabilities to monitor the overall performance and ITS network capabilities, as well as ongoing reporting provided by Securus.

The Facility Portal allows authorized users to perform functions such as managing user and facility settings, generating administrative reports, ordering materials, and creating and managing service tickets.

Users can access several standard reports through the Facility Portal:

- **Calling Activity Report** - Provides details on the number and type of calls made from a telephone number at the facility(s)

- **Call Type Summary Report** - Provides details on the number and type of calls made from a specific telephone number at the facility(s), broken down by local, intraLATA, interLATA, and interstate
- **Daily Call Volume Snapshot** - Shows a daily snapshot of calls and minutes compared to the daily average
- **Monthly Call Frequency Chart** - Details the most frequently called numbers from the facility
- **Preliminary Monthly Revenue Report** - Details all calls, minutes, and revenue for a specific date range
- **Preliminary Daily Revenue Report** - Details all calls, minutes, and revenue for a specific date
- **Investigation Tool** - Allows for tracking of a specific dialed number from any of the approximately 2,200 facilities serviced by Securus

Facility Portal Access

To access the Securus Facility Portal follow these steps:

The screenshots illustrate the following steps for accessing the Facility Portal:

1. Go to www.securustechnologies.com
2. Click Login
3. Click Log In under Facility Portal
4. Enter Username and Password
5. Click Log In

Dashboard

Once logged in users can:

- Select a specific facility
- Find contact information for the Securus team
- View call volumes and open service tickets
- Request a password change
- View alerts for maintenance times, new user account approvals, special promotions, and more

Facility Portal Dashboard View

The screenshot displays the Facility Portal Dashboard. At the top, there is a navigation bar with links for FRIENDS & FAMILY, CORRECTIONAL FACILITIES (highlighted), ABOUT US, CAREERS, and CONTACT US. Below this is the 'Facility Portal' logo. On the left, a sidebar menu lists: COUNTY CORRECTIONAL FACILITY, Dashboard, Portal Manager, Commissions Reports, General Reports, Order Materials, Downloads & User Guide, Service Center, Help, Secure Call Platform, and Log-Out. The main dashboard area features a dropdown menu for 'CORRECTIONAL FACILITY' with a 'Select' button. Below this is a welcome message: 'Welcome to the Securus Facility Portal. This Portal will allow you to submit and track Technical Support tickets, download reports, order new printed product brochures and give you access to lots of other important information.' A 'QUICK LOOK' section displays three statistics: 13 TUESDAY CALLS, 5721 MONDAY CALLS, and 1 OPEN SERVICE TICKETS. A 'GLOBAL ALERTS' section contains a red banner with the text: 'Welcome to Securus' Facility Portal. Make sure to read the Facility Portal User Guide by clicking on Downloads and User Guides to your left and then selecting User Guide. Check back often for other important alerts, updates and product information.' On the right, there is a 'Your Local Account Manager' section with a 'Quick Look' button that shows call volumes and open service tickets, and a 'Your Field Support Technician' section with contact information for Technical Support: 866.558.2323, Fax: 800.368.3168, and technicalsupport@securustech.net. Two callout boxes provide additional context: one points to the 'Global Alerts' section stating 'Global Alerts keep you updated on maintenance times, new user account approvals,' and another points to the 'Quick Look' section stating 'Quick Look shows call volumes and open service tickets'.

Managing Users and Facility Settings

The Facility Portal allows facilities to manage user accounts and profiles. Site administrators can modify existing user accounts, create new accounts, and update facility account information. Administrator access must be granted by another administrator or by a Securus technical support representative.

Manage Users

NAME	TITLE	ADMIN	COMMISSIONS	INVESTIGATIVE	REPORTS ACCESS	SERVICE TICKETS	MATERIALS ORDERING
Administrator	Administrator		X	X	X	X	X
Accounting Admin	Accounting Admin		X	X	X	X	X

Adding or updating user profiles is easy. Simply click on **Add New User** in the left menu to create additional users or click on the edit icon in the user list to modify user information, settings, and permissions.

Add User

COUNTY CORRECTIONAL FACILITY

- Dashboard
- Portal Manager
 - Manage Users
 - Add New User
 - My Profile
 - Facility Profile
- Commissions Reports
- General Reports
- Order Materials
- Downloads & User Guide
- Service Center
- Help
- Secure Call Platform
- Log-Out

Add User Profile

USER INFORMATION

S-Gate Users: Please use the same user id you were provided for your S-Gate account. *Required Fields

Username:*

First Name:*

Last Name:*

Facility:

Title:*

Address:

City:

State:*

Zip Code:*

Country:

County:

Email Address:*

Phone:*

SECURITY ACCESS

- Administrator
- Commissions Access
- Investigations Access
- Full Reporting Access
- Service Ticket Access
- Materials Ordering Access

The facility profile allows users to update facility contact and shipping information. Administrative access is required to manage this information.

Facility Profile

Facility Portal

FRIENDS & FAMILY CORRECTIONAL FACILITIES ABOUT US CAREERS CONTACT US

COUNTY CORRECTIONAL FACILITY

- Dashboard
- Portal Manager
 - Manage Users
 - Add New User
- My Profile
 - Facility Profile
- Commissions Reports
- General Reports
- Order Materials
- Downloads & User Guide
- Service Center
- Help
- Secure Call Platform
- Log-Out

Update Facility Profile

Update facility information

GENERAL FACILITY INFORMATION

Facility Name:

Main Contact:

Address:

City:

State:

Zip Code:

Country:

County:

Phone:

Email:

GENERAL SETTINGS

Contract ID:

Settings: Enable Current Commissions Report
 Enable International Call Reports

SHIPPING INFORMATION

This is for future ordering of items that will be shipped directly to your site. For example, brochures for your friends and families.

Use Same Info As Above

Address:

City:

State:

Zip Code:

Enter shipping information

After initially creating an account, all new users must be approved by the facility administrator and Securus Technologies. The facility administrator is prompted by email alerts to approve new accounts created by the Securus staff. The user receives account approval notification by email.

3.3 Mandatory Functions

For each function listed in this section, the bidder must describe in detail, and provide a detailed call-flow diagram where specified, illustrating how its proposed solution will meet DOCCS' requirements.

3.3.1 Alert Groups

The system shall allow authorized users the capability of flagging specific terminating numbers (TN) or personal identification numbers (PIN) to be placed on a watch list. When a call in progress is detected to/from any number on the watch list, the system shall optionally attempt to bridge the call with a pre-determined group of numbers to allow remote undetected monitoring of the call. The bridged party shall be informed of the origination PIN or TN and enter a security pass code to actively monitor the call.

SECURUS HAS READ, AGREES AND WILL COMPLY WITH THIS REQUIREMENT.

The Securus Secure Call Platform (SCP) provides authorized users the ability to apply a "watch" flag on any phone number. SCP will provide an indication in the live monitoring report when an inmate phone calls a watch phone number. SCP also provides the capability to search for calls made to numbers marked as watched.

The Secure Call Platform (SCP) includes the Covert Alert feature that will call an investigator on their cellular or another phone when a specific inmate places a call and offer them real-time monitoring of that call.

Covert Alert Overview

SCP's Covert Alert feature enables DOCCS to assign a "Covert Alert" status to inmate PINs, phones, or dialed numbers. When a call with a Covert Alert status takes place, SCP connects it to an investigator's phone number, allowing real-time monitoring of the call.

Summary of Additional Covert Alert Features

- ✓ Covert Alert can send calls to multiple phone numbers simultaneously, allowing multiple investigators to monitor a call.
- ✓ Covert Alert can send calls to any phone number within the facility or across the United States.
- ✓ For extra security, Coverts Alert can be configured to require a PIN to listen to the call. If activated, a customizable message will state, for example, "This is a Covert Alert call from John Smith, an inmate at the Lincoln Correctional Facility. To accept this Covert Alert call, please enter your investigator PIN now."
- ✓ Covert Alert can send E-mails to the investigator(s) with information about a Covert Alert call including date, time, inmate PIN, originating telephone, and dialed number immediately after the called party accepts the call.
- ✓ Covert Alert mutes the investigator telephone, so the inmate and the called party are not alerted to call monitoring.

- ✓ Covert Alert can be configured to allow investigators to enter a predetermined code and “Barge In” to the call to speak to both the inmate and called party.
- ✓ Covert Alert allows investigators to immediately disconnect a call.
- ✓ Covert Alert calls may be configured to be excluded from SCP Live Monitoring, restricting the monitoring of Covert Alert calls to only those investigators who are programmed to receive them.
- ✓ Covert Alert can be configured to bridge to investigators to the call before connection to the called party or upon called party acceptance.
- ✓ Authorized staff can run Covert Alert reports to view alerts triggered during a specified date and time range. Users can export results to Excel, PDF, and CSV file formats. Search criteria includes: “alertee” phone number (the investigator receiving the Covert Alert call), dialed phone number, inmate PIN, inmate first and last name, call termination category, call status, date and time range of call.

Covert Alert Call Detail Report

The screenshot displays the 'Covert Alert Call Detail Records Search' interface. At the top, there are navigation tabs: HOME, SYSTEM, MONITOR, TOOLS, ADMIN, and FACILITY PORTAL. Below this is a 'MANAGEMENT LEVEL' section with dropdown menus for Facility (Securus Demo Site), Site (All Sites), Phone Group (All Phone Groups), and Phone (All Phones).

The main search area is titled 'Covert Alert Call Detail Records Search' and includes a 'FILL IN SEARCH CRITERIA' section with the following fields:

- Alertee Country Code: []
- Country Code: []
- First Name: []
- Termination Category: -- ALL --
- Date Criteria: Date/Time Range
- Alertee Dialed Number: []
- Dialed Number: []
- Last Name: []
- Call Status: -- ALL --
- Start: 04/12/2012 00:00:00
- End: 04/19/2012 23:59:59

 Buttons for 'Search', 'EXCEL', 'PDF', 'CSV', and 'Reset' are located below the search criteria.

A callout box on the right side of the search area states: "Customize Covert Alert reports by changing search criteria—such as facility/site/phone/phone group, date range, call type, call termination, reason, call length, and much more." Arrows point from this box to the search fields.

Below the search area, the results are displayed as a table with 19 results. A callout box on the left side of the table states: "Listen to the call or save to Call Tracker case notes." An arrow points from this box to the first row of the table.

SITE	POINT LOC	QUERIED CALLED#	ALERTER NAME	TERM CAT	START	END	DUR(S)	CALLER#	ACCT#PIN	NAME	CALL STATUS	PIN ACCT#
Securus Demo Site	LP 1	9722770571	Securus Test	Parent Call Ended	04-12-2012 06:45:02	04-12-2012 06:45:22	20	4094265728	998877 998877	Jenn Test	complete	
Securus Demo Site	LP 1	9722770571	Jenn Test	No Investigator Acceptance	04-12-2012 06:46:20	04-12-2012 06:47:02	42	9722770600	998877 998877	Jenn Test	complete	
Securus Demo Site	LP 1	9722770571	Jenn Test	No Investigator Acceptance	04-12-2012 06:48:16	04-12-2012 06:48:55	39	9722770600	998877 998877	Jenn Test	complete	
Securus Demo Site	LP 1	9722770571	Jenn Test	No Investigator Acceptance	04-12-2012 06:49:59	04-12-2012 06:50:28	29	9722770600	998877 998877	Jenn Test	complete	
Securus Demo Site	LP 1	9722770571	Jenn Test	No Investigator Acceptance	04-12-2012 14:22:45	04-12-2012 14:23:03	18	9722770503	998899 225566	Adam Edwards	complete	
Securus Demo Site	LP 1	9722770571	Jenn Test	No Investigator Acceptance	04-12-2012 14:22:45	04-12-2012 14:23:17	32	9722770503	998899 225566	Adam Edwards	complete	
Securus Demo Site	LP 1086	9722770575	V.T.	Parent Call Ended	04-13-2012 14:22:45	04-13-2012 14:23:23	38	9722770503	998899 225566	Adam Edwards	complete	
Securus Demo Site	LP 1	9722770571	Jenn Test	No Investigator Acceptance	04-18-2012 02:32:33	04-18-2012 02:32:42	9	9722770600	998877 998877	Jenn Test	complete	
Securus Demo Site	LP 1	9722770571	Securus Test	No Investigator Acceptance	04-18-2012 02:34:11	04-18-2012 02:34:17	6	9722770571	998877 998877	Jenn Test	complete	

At the bottom of the interface, there are navigation controls for the results table, including a search bar and a set of playback buttons (back, forward, stop, etc.).

Covert Alert Used with Other SCP Features

Covert Alert is an invaluable tool for investigators, allowing them to monitor live conversations of inmates and called parties from anywhere in the world while they are taking place. This feature can be used in conjunction with many other SCP features to enhance investigations. Examples include:

- ✓ Billing Name and Address Lookup – Investigators can run a Covert Alert report in SCP and click on the dialed number to access a pop-up box providing the billing name and address of the dialed number. This turns a simple phone number into usable data. By using simple mapping features, investigators can even view the address on a map.
- ✓ Call Tracker – Investigators can run a Covert Alert call and then add it to an investigation or case through Call Tracker. From there, staff can add a tracking number, gang affiliation, and any other notes to the call. Additionally, this feature allows authorized users to either keep the note private or selectively share the note with other users. Users can also view previous notes associated with the same call from the easy to use notes screen.
- ✓ Security Templates and System Logs – Use Security Templates to customize Covert Alert security. Investigators can be authorized to view all reported Covert Alert events in SCP or only those forwarded to their phone numbers. Administrators can view and manage user activity of Covert Alert reports and recordings through user-friendly System Logs.

- **Describe how your proposed solution will buffer or delay the monitored calls' audio to allow DOCCS' staff to hear the entire call.**

SECURUS HAS READ, AGREES AND WILL COMPLY WITH THIS REQUIREMENT.

The feature's integrated media player has a time shifting (buffer or delay) capability enabling the investigator to pause, rewind and replay the entire call even as recording continues. The investigator can replay any part of the conversation even after the call has ended. The media player automatically buffers the entire call, allowing the user to have complete control to move forward and backward through the call audio to either hear the entire call or focus on a specific portion of a call. This is accomplished using a simple click and drag method, along with audio controls such as Play, Pause and Stop.

SCP also allows authorized users to forward a call to an investigator and quickly identify calling patterns to the currently called number or phone in use.

- **Explain how this buffer or delay can be adjusted and provide the parameters available for the adjustments.**

SECURUS HAS READ, AGREES AND WILL COMPLY WITH THIS REQUIREMENT.

The Securus Secure Call Platform (SCP) allows authorized users to live monitor calls in progress via any device connected to the Internet. The feature's integrated media player has a time shifting capability enabling the investigator to pause, rewind and replay even as recording continues. The investigator can replay any part of the conversation even after the call has ended. The media player automatically buffers the entire call, allowing the user to have complete control to move forward and backward through the call audio to either hear the entire call or focus on a specific portion of a call. This is accomplished using a simple click and drag method, along with audio controls such as Play, Pause and Stop.

SCP also allows authorized users to forward a call to an investigator and quickly identify calling patterns to the currently called number or phone in use.

- **In addition to the written description, provide a call-flow diagram detailing the entire process from the time that the inmate goes off-hook through call termination.**

SECURUS HAS READ, AGREES AND WILL COMPLY WITH THIS REQUIREMENT.

SCP Call Flow

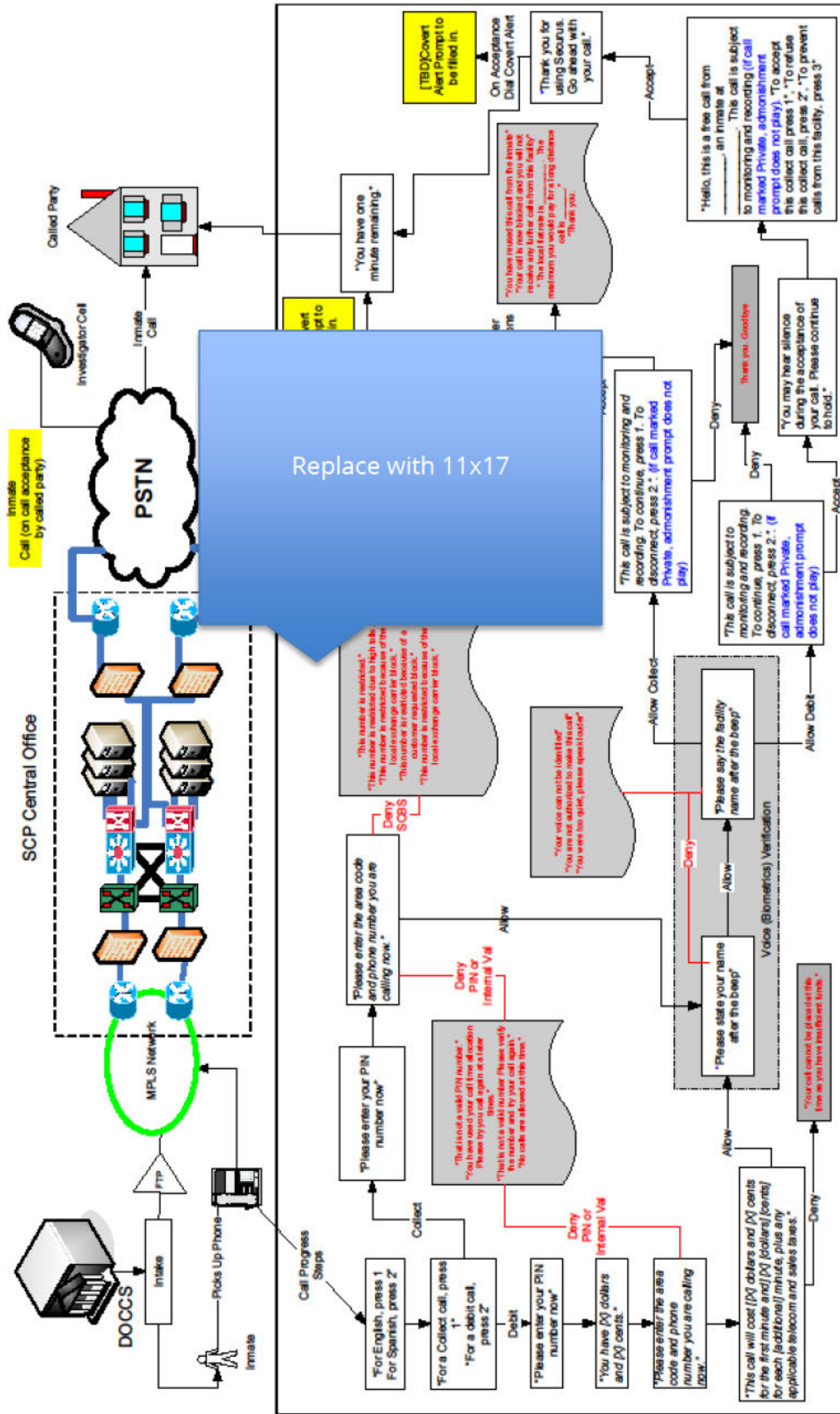

3.3.2 Pre-recorded Names

The system shall prompt the inmate to record his/her name when a PIN is first used. The system must provide the ability for an inmate to playback the recorded name and rerecord the name prior to accepting the recording. Once the recording is accepted, the inmate shall not have the ability to modify or erase the recording without action by DOCCS to review and delete the original recording. The recorded name shall be used in all subsequent announcements made to the called party.

SECURUS HAS READ, AGREES AND WILL COMPLY WITH THIS REQUIREMENT.

3.3.3 Access to Rape Crisis Programs

The Department must enable reasonable communication between inmates and Rape Crisis Programs, in as confidential a manner as possible. Based upon the model currently being tested through a pilot program, the Department has entered into cooperative agreements with regional Rape Crisis Programs to permit direct telephone access from the inmate phone system, as well as follow-up services via staff assisted calls and legal visits. The Department anticipates building on this model, but must be flexible as providers change.

In the future, DOCCS anticipates continuation and expansion of a pilot project model that permits inmates to dial a speed dial (#77) to be routed to a designated Rape Crisis Program. DOCCS expects to designate additional numbers that can be direct dialed by any inmate either at selected facilities or at all facilities.

SECURUS HAS READ, AGREES AND WILL COMPLY WITH THIS REQUIREMENT.

- A. The Department requires the ability to continue its current model of designating a destination number for a standardized speed dial. Inmates in any facility will be permitted to dial #77 and have their call routed to a predetermined Rape Crisis Program based upon the facility they are in at the time of the call.
 1. The Department requires the ability to change the destination number when providers change.
 2. Calls placed via #77 will be free of charge.

SECURUS HAS READ, AGREES AND WILL COMPLY WITH THIS REQUIREMENT.

- B. In addition, the Department requires the ability to designate certain telephone numbers as “free” calls that can be dialed by any inmate at a designated facility or facilities, or at all facilities.
 1. Designated numbers may include direct dial (e.g., 518-xxx-xxxx) or toll free (e.g., 800-xxx-xxxx) numbers.

SECURUS HAS READ, AGREES AND WILL COMPLY WITH THIS REQUIREMENT.

2. The Department needs the ability to add or delete individual numbers or groups of numbers from this list throughout the life of the contract.

SECURUS HAS READ, AGREES AND WILL COMPLY WITH THIS REQUIREMENT.

- C. For all numbers (those associated with the #77 speed dials and other designated Rape Crisis Program telephone numbers), DOCCS requires the ability to indicate that call detail records should be suppressed from view at the facility level.

SECURUS HAS READ, AGREES AND WILL COMPLY WITH THIS REQUIREMENT.

- D. The default for these numbers would be that both call detail information and monitoring at the facility level is suppressed. However, DOCCS should be able to independently change each of these rules for each telephone numbers. Call detail information will not be suppressed from certain Central Office level reports.

In all cases, calls are recorded and accessible to Central Office investigators (e.g., Office of Special Investigations).

SECURUS HAS READ, AGREES AND WILL COMPLY WITH THIS REQUIREMENT.

3.3.4 Access to Toll-Free Assistance Lines

The Department requires the ability to designate certain telephone numbers as “free” calls (e.g. smokers’ quit line, substance abuse help line, etc.) that can be dialed by any inmate using an agreed upon speed dial number at a designated facility or facilities, or at all facilities.

Designated numbers may include direct dial (e.g., 518-xxx-xxxx or toll free 800-xxx-xxxx) numbers. The Department needs the ability to add or delete individual numbers or groups of numbers from this list throughout the life of the contract. The called number must be hidden from the inmate at all times.

SECURUS HAS READ, AGREES AND WILL COMPLY WITH THIS REQUIREMENT.

3.3.5 Announcements

Upon delivery of the call, the system must clearly announce to the called party that the call is from a NYS Correctional Facility, the facility name, and the inmate’s pre-recorded name. The system shall allow the called party to optionally hear current rates and actively accept or deny the call by pressing a key on the touch-tone dial pad. The event shall be identified and recorded in call detail records.

In addition to a written description, provide a call-flow diagram detailing the entire process from the time that the inmate goes off-hook until call termination.

SECURUS HAS READ, AGREES AND WILL COMPLY WITH THIS REQUIREMENT.

SCP is capable of operating in a combination of collect call and debit modes depending on the facility and the unique needs of DOCCS.

Specific Inmate Calling Process

The inmate calling process is:

1. The inmate picks up the telephone.
2. The inmate hears “For English press 1.” [In Spanish] For Spanish, press 2.” (Securus can add additional languages on request)
3. “For a collect call, press 1.”
4. “For a debit call, press 2.”

The following table provides calling options and the associated announcements:

Inmate Calling Options

Inmate Chooses Collect Call Option

“Please enter your PIN number now.”
(repeated)

“Please enter the area code and telephone number you are calling now.”
(repeated)

If voice biometrics is being used, “You will be asked to verify your voice now. Please say your name after the beep.”

If voice biometrics is being used, “Please say the facility name after the beep.”

“This call is subject to monitoring and recording. To continue, press 1. To disconnect, press 2.”

“You may hear silence during the acceptance of your call. Please continue to hold.”

Inmate Chooses Debit Call Option

“Please enter your PIN number now.” *(repeated)*

“You have (X) dollars and (X) cents.”

“Please enter the area code and telephone number you are calling now.” *(repeated)*

“This call will cost (X) dollars and (X) cents for the first minute and (X) dollars and (X) cents for each additional minute, plus any applicable telecom and sales taxes.”

If voice biometrics is being used, “You will be asked to verify your voice now. Please say your name after the beep.”

If voice biometrics is being used, “Please say the facility name after the beep.”

“This call is subject to monitoring and recording. To continue, press 1. To disconnect press 2.”

“You may hear silence during the acceptance of your call. Please continue to hold.”

Specific Friends and Family Process

The following table provides the friends and family process when receiving a call, and the associated announcements:

Friends and Family Receiving Call Process

Collect Call

"Hello. This is a collect call from (*Inmate Name*), an inmate at the (DOCCS facility name). This call is subject to monitoring and recording."

"To accept this collect call press 1. You may start your conversation now."

"To refuse this collect call, press 2."

"To prevent calls from this facility, press 6."

"For a rate quote press 7."

Debit Call

"Hello. This is a debit call from (*Inmate Name*). An inmate at the (DOCCS facility name). This call is subject to monitoring and recording."

"To accept this debit call press 1. You may start your conversation now."

"To refuse this debit call, press 2."

"To prevent calls from this facility, press 6."

"For a rate quote press 7."

During the call, random announcements (Voice Overlay) will be heard by both calling and called parties as designated by DOCCS. At one minute before the maximum call duration, the "One Minute Remaining" message is played.

The Securus SCP plays Voice Overlay messages throughout the call as an additional fraud deterrent. The established message may be programmed to play at one-minute increments or random intervals. An example of a Voice Overlay message is "*This call is from* (DOCCS facility name)."

SCP Call Flow

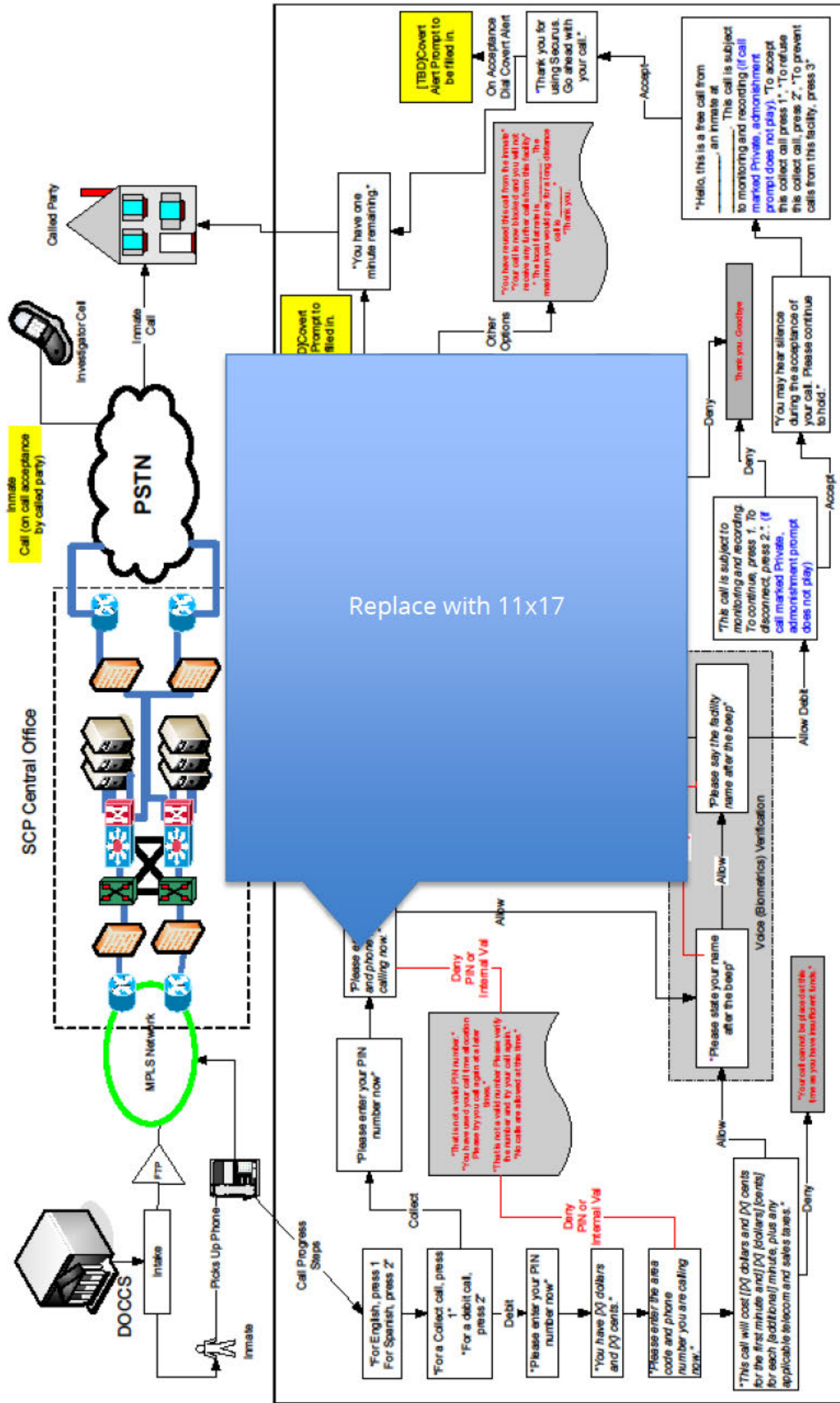

3.3.6 Automatic Number Identification

The Automatic Number Identifier (ANI) for all ITS calls must identify to the called party both New York State Department of Corrections and Community Services and the specific correctional facility name from which the call originated. DOCCS requires a unique ten-digit telephone number be used to identify each of its correctional facilities to the called party and, the ten-digit numbers used for ANI be phantom telephone numbers incapable of receiving incoming calls. The unique telephone station identifier (i.e. extension number, port assignment, or location) used to identify the individual ITS telephones within a facility must not be used as part of the ANI information transmitted to the called party.

Describe how this capability will be provided.

SECURUS HAS READ, AGREES AND WILL COMPLY WITH THIS REQUIREMENT.

To ensure maximum security to the system, Securus provisions the trunks in the SCP data center as outgoing-only; ensuring that no incoming calls can reach the inmate. Securus has performed full testing of these trunks, verifying compliance with this requirement. Each outgoing trunk for the DOCCS system will be assigned a specific ANI that will be associated with, and identify, the individual DOCCS facility from which calls have originated. This is configured by Securus staff during the project implementation and can be changed by our technicians should a need arise during the contract term. Because these are phantom ANI's, they are provisioned so that they are not capable of receiving incoming calls. Additionally, these phantom ANI's will not be utilized in the identification or port assignment with respect to any inmate telephone on the system.

3.3.7 Billing Name and Address Lookup

The system shall allow authorized DOCCS' staff to perform billing name and address lookup of the called party number using at a minimum the Local Exchange Carrier (LEC) Line Information Data Base (LIDB.)

Describe how this capability will be provided and any additional capabilities that are available.

SECURUS HAS READ, AGREES AND WILL COMPLY WITH THIS REQUIREMENT.

The Securus Secure Call Platform (SCP) reverse lookup feature identifies the billing name and address (BNA) of a dialed phone number captured in a call detail record. Users can easily point, click, and initiate a BNA search for the number in private and external data sources. This search process is unique in the industry, providing the most accurate BNA information possible.

Billing Name and Address Lookup

When the search returns a positive match for a destination phone number, a pop-up box appears on the screen with phone number's billing name, billing address, and the date the number was last verified. Unlike other similar tools in the industry today, the Securus fully-integrated reverse lookup feature is provided at no additional cost.

Reverse lookup allows users to access results from anywhere the number exists in SCP such as:

- Call detail reports
- Blocked number lists
- Global allowed lists
- Call frequency reports

Secure Call Platform Facility Routing Number: 9900

HOME SYSTEM MONITOR TOOLS ADMIN FACILITY PORTAL

MANAGEMENT LEVEL
Facility: Secure Demo Site

Call Detail Records Search

FILL IN SEARCH CRITERIA (* Indicates Required Fields)
(Use ! for wild card / partial searches)

Country Code: [] Dated Item: [] International:
 Custody Account #: [] First Name: [] Last Name: [] Vished:
 Termination Category: [] Blocked Reason: [] Call Status: [] Private:
 Cell Type: [] Date Criteria: [] Start: [] End: [] Results Per Page: [] Text Call:
 RCF:

5 Results

REC	REC ID	RECORD #	START	END	DUR
[]	Secure Demo Site	LP 7 (1) 9722770556 Local	05-11-2011 09:44:03	05-11-2011 09:49:03	200 (2) 5 (m)
[]	Secure Demo Site	LP 7 (1) 9722770556 Local	05-11-2011 09:50:10	05-11-2011 09:54:32	262 (2) 4:37 (m)
[]	Secure Demo Site	LP 7 (1) 9722770556 Local	05-11-2011 09:56:19	05-11-2011 10:26:19	1200 (1) 20 (m)
[]	Secure Demo Site	LP 7 (1) 9722770556 Local	05-11-2011 10:27:03	05-11-2011 10:33:59	294 (1) 4:57 (m)
[]	Secure Demo Site	LP 7 (1) 9722770556 Local	05-11-2011 10:36:17	05-11-2011 11:14:33	2296 (1) 38:27 (m)
[]	Secure Demo Site	LP 7 (1) 9722770556 Local	05-11-2011 11:30:35	05-11-2011 12:07:00	2185 (1) 36:42 (m)

Name & Address Verification

Phone Number: 9722770556

Last Verified: 26-Mar-2011 13:12:19:059

Name: SECURUS SECURUS ATTN: ACCOUNTS PAYABLE

Address: 14851 DALLAS PKWY STE 600, DALLAS, TX 75254-8815

Close

[View History](#)

Dedicated BNA Search Screen

Secure Call Platform Facility Routing Number: 99001

HOME SYSTEM MONITOR TOOLS ADMIN FACILITY PORTAL

MANAGEMENT LEVEL
Facility: Secure Demo Site

BNA Search

FILL IN SEARCH CRITERIA (* Indicates Required Fields)
(Use ! for wild card / partial searches)

Phone Number: 9722770490

First Name: [] Middle Name: [] Last Name: []

Address: [] City: [] State (2-letter): [] Zip: []

Search Result

1 Results Page 1 of 1

PHONE #	NAME	ADDRESS	LAST VERIFIED
9722770490	SECURUS SECURUS ATTN: ACCOUNTS PAYABLE	14851 DALLAS PKWY STE 600, DALLAS, TX 75254-8815	12-Nov-2010 15:46:25.524

Reverse Lookup and Personal Allowed Numbers (PAN)

If using PAN management, SCP allows authorized users to associate the BNA information to a phone number on the PAN list. This feature allows administrators and investigative staff to view BNA information without an additional search. The Securus reverse lookup feature offers a comprehensive ad hoc search tool giving an authorized user the ability to enter criteria ranging from first name, last name, address, city, state, and ZIP to obtain this information on demand.

Viewing BNA Information on an Online Map

Securus SCP integrates with Google Maps proving a quick and easy way see the physical location of the address associated with a telephone number. Highlighting any telephone number and clicking it renders a Google Map on the screen.

Mapping BNA Information

The screenshot displays the 'Secure Call Platform' interface. At the top, there are navigation tabs: HOME, SYSTEM, MONITOR, TOOLS, ADMIN, and FACILITY PORTAL. Below this is a 'MANAGEMENT LEVEL' section with dropdown menus for Facility (Securus Demo Site), Site (Securus Demo Site), Phone Group (All Phone Groups), and Phone (All Phones). A 'Call Detail Records Search' section includes fields for Custody Account, First Name, Termination Category, Call Type, and Date Criteria (Start: 05/05/2011 00:00:00). A 'Name & Address Verification' popup window is open, showing details for Phone Number 8722770341, Last Verified 10-Apr-2011 10:08:51.174, Name SECURUS SECURUS 4TH ACCOUNTS PAYABLE, and Address 1465 DALLAS PKWY STE 600 DALLAS, TX 75244-0810. A context menu is visible over the address, with 'Map with Google Maps' selected. Below the popup is a table of '15 Results' (PAGE 1 OF 1) with columns: SITE, PORT LOC, DIAL ED #, START, END, DURN, ACCT #, PIN, PREPAID ACCT#, and NAM. The first row shows a call from Securus Demo Site (LP 46) to a local number (92222770343) on 09-09-2011. The second row shows a call from Securus Demo Site (LP 31) to a number (809990011006) on 05-06-2011. To the right of the table is a Google Map showing the location of the address in Dallas, Texas, with labels for Arapaho Rd, Addison Circle Park, Belt Line Rd, Dallas Parkway, Spring Valley Rd, and Cecebal Rd. A red location pin is placed on the map at the address location.

	SITE	PORT LOC	DIAL ED #	START	END	DURN	ACCT #	PIN	PREPAID ACCT#	NAM
	Securus Demo Site	LP 46	(1) 92222770343	09-09-2011 14:14:25	09-09-2011 14:14:30	5 (s) 0:08 (m)	0000243	00343		QAT
	Securus Demo Site	LP 31	(1) 809990011006	05-06-2011 14:58:14	05-06-2011 14:58:59	25 (s) 0:42 (m)	3434	3434		ca b

3.3.8 Class of Restriction (COR)

The ability to apply restrictions to individual phones shall be based on a COR associated with each telephone. The vendor must support at a minimum the ability to restrict phones with the following levels:

Level	Pin	Action
Level 1	Required	Calling list required
		Disciplinary hold applies
Level 2	Required	Calling list required
		Disciplinary hold does not apply
Level 3	Required	Calling list not Required
		Disciplinary hold does not apply

Describe how this capability will be provided.

SECURUS HAS READ, AGREES AND WILL COMPLY WITH THIS REQUIREMENT.

Calling Restrictions enable control of calling activity— such as call durations— by inmate, by port, by multiple phone groups, by customer, or by facility. The facility can set a maximum time limit for any call type or all calls related to an individual PIN or all PINs. Users can assign multiple restrictions to any PIN or telephone number associated with a PIN.

Examples of restrictions are:

- Personal Allowed Number (PAN) list required/not required
- Maximum duration of a call for PIN
- Maximum number of calls from that PIN per day/week/month.

All imposed calling restrictions are automatically managed by the calling platform to relieve facility staff of calling restriction maintenance responsibilities.

If restraining orders or called party financial conditions require a limit to the length of time or monthly cost of inmate calling to a particular party, SCP automatically denies calls that exceed such thresholds.

The Securus Calling Restrictions capability also provides additional PIN suspension features to help facility staff maintain control of inmate activity. Administrators can suspend a single or multiple inmates PINs from either the on-site administrative terminal or an authorized remote terminal. This suspension feature, frequently used for punitive reasons, allows the facility to deny telephone privileges to one or more inmates without affecting other inmates who share the same

inmate telephones. SCP enforces the PIN denial for the duration entered. This feature allows inmates to make privileged calls if necessary, even while calling privileges are suspended. Direct manual control of this suspension feature is also allowed from the on-site administrative terminals or authorized remote terminals.

Calling Restrictions – Sample Screen

HOME SYSTEM MONITOR TOOLS ADMIN FACILITY PORTAL

MANAGEMENT LEVEL

Facility: Securus Demo Site >> Site: All Sites >> Phone Group: All Phone Groups >> Phone: All Phones >>

General Global Lists **Calling Restrictions**

Calling Restriction Name: jaz_test *
Status: ACTIVE *

DEFINE RESTRICTIONS BELOW

RESTRICTION TYPE	DESCRIPTION	CALL TYPE	ACTION	ENABLE	EXCLUDE PRIVATE	PERIOD	DAYS	DAY OF WEEK	DAY OF MONTH	ACCEPTS	MIN	CONNECTS
Custody/Acct	jaz	14 Selected	LIMIT	<input type="checkbox"/>	<input type="checkbox"/>	DAY	1			10	20	10
Custody/Acct	jaz2	14 Selected	LIMIT	<input type="checkbox"/>	<input type="checkbox"/>	WEEKLY		Monday		1	1	1
Custody/Acct	jaz3	COLLECT	LIMIT	<input checked="" type="checkbox"/>	<input type="checkbox"/>	DAY	1			1	1	1
Custody/Acct	jaz4	CRIME TIP	LIMIT	<input type="checkbox"/>	<input type="checkbox"/>	DAY	1			1	11	1
---		No selection	---	<input checked="" type="checkbox"/>	<input type="checkbox"/>	DAY	0			0	0	0

Save Cancel

3.3.9 Investigative tip line

The system must permit future adoption of a “tip line” that permits a call to be placed from any inmate telephone and to leave a recorded message. The system must meet language access requirements, permit recorded messages to be transmitted to designated email addresses as WAV files, and permit remote access by designated users.

SECURUS HAS READ, AGREES AND WILL COMPLY WITH THIS REQUIREMENT.

The Securus Crime Tip feature is an inmate crime tip reporting tool that gives inmates an anonymous and secure way to provide crime tips to corrections officers, while maintaining the required language and security measures of DOCCS. The Secure Calling Platform (SCP) system anonymously records all messages left on the Crime Tip Hotline, so inmates do not have to risk being identified as an informant. Authorized users can email Crime Tip recordings to designated addresses, similar to the capabilities of other recordings within the system.

Inmates can choose to report:

- Information about possible criminal activity, including narcotics
- A crime that has already taken place
- A threat to their safety

- Threats to the safety of others

While tips are anonymous as a default, informants may choose to leave their name.

The Securus Crime Tip feature includes:

- A pre-arranged telephone number (designated by the facility), provided to all inmates
- An option to listen to all or selected recorded messages
- An option to burn specific information onto CDs for use as evidence
- A way to generate reports of all recorded messages with the date and time of the message
- A way to leave an anonymous reply message to the inmate

As with all features of the SCP user interface, the Crime Tip Hotline is available remotely, via virtually any internet connected computer or device by designated, authorized user.

3.4 Mandatory Features

The following features are required elements for the DOCCS' Inmate Telephone System.

Describe specifically how your proposed solution provides the same functionality for each of the following features.

3.4.1 Harassment Blocks

The system shall support the automatic denial of a PIN when a remote party refuses to accept a call. The called party must be provided with the option to either accept or block each call prior to being connected to the inmate.

Explain how your system accomplishes this and whether blocking can be done at the PIN, facility or system level; if all future calls from that PIN or facility are blocked; and what steps are required to unblock future calls.

SECURUS HAS READ, AGREES AND WILL COMPLY WITH THIS REQUIREMENT.

SCP provides the ability to block numbers at the PIN, facility and system level. This is accomplished through a variety of features within the user interface. Blocking a number at the PIN level is typically maintained through the use of Personal Allowed Number (PAN) lists, while blocking at the facility or system level is best handled using the Global List functions. Additionally, called parties have the ability automatically block all future calls using out patented PermaBlock feature.

Our PermaBlock process allows the called party to block his/her number in real time, prior to accepting the call to prevent future harassing calls by any inmate in the facility. During the call acceptance the call party is given a menu of options. One option instructs the called party to press "6" on their dial pad to prevent further calls from that specific DOCCS facility. The PermaBlock feature reduces facility labor demands and reduces called party complaints by automatically handling call blocking requests at the point of contact, at the time of contact. If the

called party wishes to block all calls from all DOCCS facility they would need to call Securus' toll free 800 customer service number and speak with one of our customer service representatives.

During installation, a global call blocking table is established, which immediately prevents inmates from making calls to specific numbers. Typically, the database includes numbers to local judges, sheriffs, facility personnel, jury members, attorneys and witnesses. Because a global call blocking table may contain thousands of entries, Securus' SCP offers unlimited blocking potential.

All dial-around area codes and exchanges, such as 800, 900, and 976, are blocked by default. In addition, access to live operator services, such as 0, 411, and 911, are blocked by default.

To provide maximum convenience to facility personnel, authorized facility personnel can administer blocked numbers or unblock numbers using our single-point access, or by calling Securus' Technical Support directly. All blocked numbers have an associated "Note" field stored in the blocked number database to record specific information for future reference.

Automated Operator Services

SCP includes an Interactive Voice Response (IVR) system that provides Automated Operator Services (AOS). This automated assistance uses clear and concise, professionally recorded voice prompts to establish call acceptance and to assist inmates and called parties throughout the calling process.

When the called party answers the phone, SCP's advanced answer detection triggers the call acceptance voice prompt. The called party hears, "Hello, you are receiving a collect call from [inmate's name], an inmate at the [DOCCS facility]. This call is subject to monitoring and recording." SCP then gives the called party the following menu options:

- "To accept this call, press 1."
- "To refuse this call press 2."
- "To hear the rates and charges for this call, press 7."
- "To block future calls to your number, press 6."

Additional options provided by AOS include:

Available Options to Called Parties

Request a rate quote
Hear the name of the facility and inmate calling
Accept or reject the call
Request available balance of an AdvanceConnect account or available credit of the Direct Bill account
Hear instructions on how to add more

Available Options to Inmates

Listen to prerecorded announcements
Choose to place a collect or debit call; if debit, PIN entry is requested, the inmate hears the available balance in their account and the cost of the call
Select a specific language at the beginning of the call (if configured)
Acknowledge that the call is going to

money to their prepaid account or pay their Direct Bill Account

Connect to a live agent to setup a pre-paid account

Choose to hear the prompts on the system in English, or the language selected by the inmate (if configured for this option)

Pay for the incoming call with InstantPay (if available)

Hear optional marketing message (by request of DOCCS)

Block their number prior to accepting a call using SCP's patented Perma Block technology*

be monitored and recorded

Hear available call time (prompt will tell the inmate call time limits based on calling schedules or calling restrictions)

Identify themselves by PIN or Voice Biometrics (if configured)

Add, remove, and/or listen to the phone numbers on their PAN list (if configured)

Hear optional marketing message (by request of DOCCS)

***SCP's automated operator also provides a patented Perma Block process, which allows a called party to block their number permanently. This feature may be used to block calls from any inmate in the facility. The ability to immediately block calls helps reduce the number of called party complaints. The called party can also choose to end the call by hanging up. A called party can contact the call center to unblock future calls.**

Numbers that are blocked using the PAN or Global List features can be easily unblocked by authorized users within the SCP user interface. Once a called party has elected to block their number using PermaBlock, they must contact Securus Customer Support in order to have the block removed.

3.4.2 Call Termination

The system shall allow authorized system users to instantly terminate a call in progress. The system must identify the event in call detail records and log the action separately identifying at a minimum the facility, date, time, PIN and the user-id of the individual terminating the conversation. The system must provide the ability for DOCCS to create ad-hoc reports detailing this activity by facility or system-wide at a minimum.

Provide details on the reporting capabilities.

SECURUS HAS READ, AGREES AND WILL COMPLY WITH THIS REQUIREMENT.

The Securus Secure Call Platform (SCP) allows authorized users to live monitor calls in progress via any device connected to the Internet, and instantly terminate a call in progress. The feature provides users selectable scanning of all live calls in progress, so the user does not have to scan phones that are not in use.

Live Call Monitoring

The feature's integrated media player has a time shifting capability enabling the investigator to pause, rewind and replay even as recording continues. The investigator can replay any part of the conversation even after the call has ended.

The system's easy-to-use dashboard automatically collects and analyzes a vast amount of information that would otherwise require labor-intensive gathering and interpretation. Investigator Pro will dramatically change the gathering, sharing, and use of evidence in the investigation and prosecution process. It is an evidence case-management tool with the highest level of integrity, efficiency, and demonstrated effectiveness.

Investigator Pro will assist investigators in targeting calls to review and provides a sophisticated playback system with the power to play and annotate calls faster, with less duplication of effort.

Additional Investigator Pro features include:

- Ability to separate recorded voices and play back individual voices independently
- Speed up or slow down a conversation or single voice within a recording
- Playback module include user-friendly, intuitive buttons
- Report feature allows for supervisory oversight, accountability, and assessment of facility staff's investigative skills and activities

Continuous Voice Identification with Investigator Pro

Investigator Pro's advanced voice identification technology was originally developed for the U.S. Department of Defense (DOD). The DOD needed to identify terrorist calls out of the millions of calls made to and from the United States every day. The DOD contracted with a major U.S. technical university with the best voice analysis engineers in the world to find a way to detect these calls. Over a 12-year period, the engineers created a cutting-edge solution that could automatically analyze millions of daily calls. That solution is still protecting the U.S. today. Through its relationship with the technical university, JLG Technologies (now owned by Securus) received an exclusive license to bring this revolutionary technology to the corrections market.

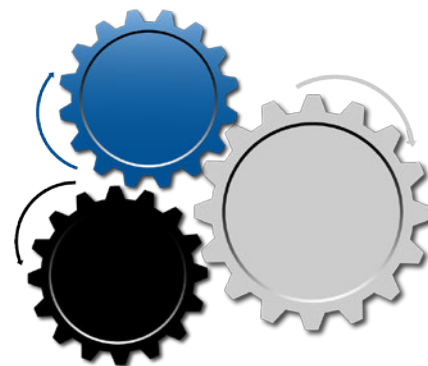

Investigator Pro analyzes voice data immediately after call completion. Alerts are instantly available after each voice analysis. Unlike competitive offerings, investigator Pro analyzes every second of every call. Intermittent verification on other platforms allows inmates to converse undetected by passing the telephone when verification is requested.

Anatomy of Investigator Pro™

Investigator Pro is designed to provide investigators with the tools they need to expose inmates who attempt to hide their identities. Included are an advanced call player, multiple reports, and an interactive dashboard.

Investigator Pro modules include:

- QuickFind™—Puts critical information at your fingertips

- Voice Search™—Find calls containing a specific inmate's voice
- CallFinder™—Filter calls based on dozens of criteria
- MyCallReview™—Return to the calls important to you
- Suspicious CallFinder™—Find all high-suspicion calls
- NoteManager™—View, filter, and create notes on calls
- ReportMaker™—Run reports on various telephone system abuses
- Stats—View key messages and monitor analysis progress

Sample Investigator Pro Modules

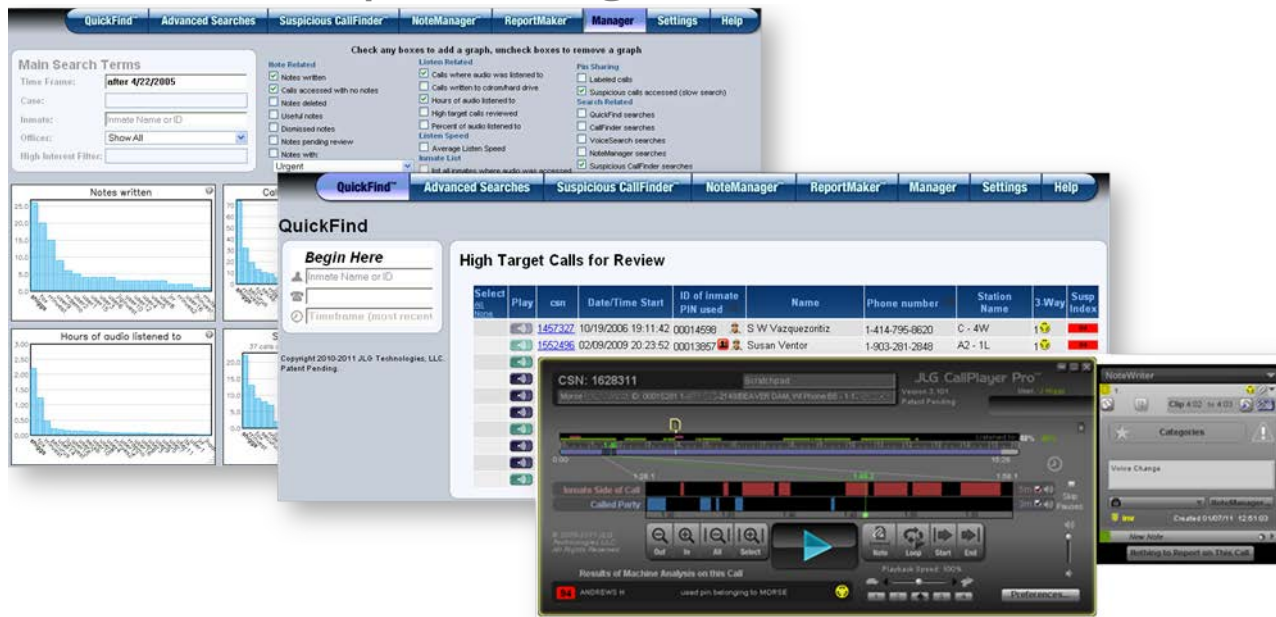

Call Detail Report

The Call Detail Report (CDR) provides investigators an intuitive and user-friendly report to view or search virtually anything related to an inmate call, including:

- ✓ Site name from which the call originated
- ✓ Phone location as labeled in the system
- ✓ Facility code
- ✓ Dialed number
- ✓ Start date/time
- ✓ End date/time
- ✓ Duration of call
- ✓ Inmate Account Number

- ✓ Inmate PIN
- ✓ Prepaid card number if used
- ✓ Inmate first, middle, and last name
- ✓ Type of call (voice mail, person call, prepaid call, debit call)
- ✓ Status of call (complete/incomplete)
- ✓ Reason for call termination
- ✓ Reason for block
- ✓ Call properties (watched number, RCF detected, **three-way attempt**, private number)
- ✓ Destination zone
- ✓ Desired results per page

Call Detail Report

Secure Call Platform Facility Routing Number: 99001

HOME SYSTEM MONITOR TOOLS ADMIN FACILITY PORTAL

MANAGEMENT LEVEL
 Facility: Securus Demo Site Site: All Sites Phone Group: All Phone Groups Phone: All Phones

Call Detail Records Search

FILL IN SEARCH CRITERIA (* Indicates Required Fields)
 (Use * for wild card / partial searches)

Country Code: [] Dialed Number: [] Destination Zone: -- ALL -- International:
 Custody Account #: [] PIN #: [] Prepaid Account #: [] Watched:
 First Name: [] Last Name: [] Private:
 Termination Category: -- ALL -- Blocked Reason: -- ALL -- 3-way:
 Call Type: -- ALL -- Cell Status: Complete Voice Biometrics:
 Date Criteria: Date/Time Range Results Per Page: 10 Test Call:
 Start: 04/21/2011 00:00:00 End: 04/26/2011 23:59:59 RCF:

Search EXCEL PDF CSV Reset

140 Results PAGE 1 OF 14 >>> EXCEL PDF CSV

	SITE	PORT LOC	DIALED #	START	END	DUR	ACCT # PIN	PREPAID ACCT#	NAME	CALL TYPE	CALL STATUS	TERM CAT	BLOCKED REASON	CALL PROPERTIES
	Securus Demo Site	je test 4 (1)	Local	04-21-2011 01:10:58	04-21-2011 01:11:08	10 (s) (m)				Person Call	complete	Called party hangup		Language: English
	Securus Demo Site	je test 4 (1)	Local	04-21-2011 01:13:28	04-21-2011 01:14:35	67 (s) (m)				Debit	complete	Facility terminated call		Language: English Test Call Charge: \$3.35 Tax: \$0
	Securus Demo Site	je test 4 (1)	Local	04-21-2011 01:27:29	04-21-2011 01:28:12	43 (s) (m)				Debit	complete	Facility terminated call		Language: English Test Call Charge: \$2.15 Tax: \$0

⏪ ⏩ ⏴ ⏵ ⏸ ⏹

Also, Call Detail Record (CDR) reports allow users to:

- ✓ Add notes to a call record or a tracking number
- ✓ Mark the notes private or public
- ✓ Play the call
- ✓ Copy the call to a management folder for download
- ✓ Download the call immediately with a one click operation

- ✓ Extend the call expiration date if it is approaching the agreed upon storage threshold
- ✓ Export the report results (users can export all SCP reports)
- ✓ Select a single site, all sites, or allowed sites, and specify information by phone, phone group, or the entire customer profile.

3.4.9 Hours of Operation

The solution shall allow DOCCS to set parameters that determine the hours of operations for inmate phone services. The default shall be set to allow services to be available from 7:00 a.m. to 11:00 p.m. ET. At DOCCS direction, individual phones or groups of phones may be further restricted.

SECURUS HAS READ, AGREES AND WILL COMPLY WITH THIS REQUIREMENT.

3.4.10 Call Duration

The system shall allow DOCCS to control the maximum call duration at each facility. Current call duration is one half (1/2) hour.

SECURUS HAS READ, AGREES AND WILL COMPLY WITH THIS REQUIREMENT.

3.4.11 Telephone Testing

The vendor shall provide the ability to allow DOCCS staff to test telephones at any location, at no charge to DOCCS, to assure that they are fully operational. The vendor shall provide unique PINs with a DOCCS-defined PAN list to be used by DOCCS' staff when testing phones.

SECURUS HAS READ, AGREES AND WILL COMPLY WITH THIS REQUIREMENT.

3.4.12 Languages

The system prompts will be available in all of the following languages: English, Spanish, Chinese, Russian, Haitian Creole, Korean, and Italian. (See [Section 4.2.2](#) for more information about required languages.) The selected Contractor will agree to support additional languages during the life of the resulting contract.

Describe how your proposed system is able to support other languages. Include all the languages that will be supported.

SECURUS HAS READ, AGREES AND WILL COMPLY WITH THIS REQUIREMENT.

The Securus automated operator uses clear, concise, professionally recorded voice prompts to assist the inmate through the calling process. By default, the Securus Secure Call Platform (SCP) offers language prompts in both English and Spanish. Securus can provide additional languages on request and at a minimum will provide English, Spanish, Chinese, Russian, Haitian, Creole, Korean and Italian. SCP can be configured to provide prompts in as many as nine languages.

Multilingual Language Prompts

Some examples of languages that Securus has implemented in the past include:

Afrikaans	Hebrew	Slovak
Arabic	Hindi	Slovene
Bahasa	Hungarian	Somali
Bulgarian	Icelandic	Spanish (U.S., Mexico, Puerto Rico, Central and South America, Castilian dialects)
Chinese (all dialects)	Italian	
Creole/Haitian	Japanese	
Croatian	Javanese	Swedish
Czech	Kannada	Tagalog
Danish	Korean	Taiwanese
Dutch	Latvian	Tamil
Estonian	Lithuanian	Telugu
Finnish	Malay/Malayalam	Portuguese (Brazil and Portugal dialects)
Flemish	Marathi	
French (Canadian and Parisian dialects)	Norwegian	Turkish
	Polish	Urdu
German/Bavarian	Punjabi	Ukrainian
Greek	Romanian	Vietnamese
Gujarati	Russian	

After the language prompts are set up in the SCP system, inmates select their language choice at the beginning of the call process by dialing a single digit.

During call acceptance, the called party receives the acceptance instructions in English first followed by an option to continue in the language selected by the inmate. This fraud deterrent feature eliminates inmate attempts to confuse called parties with a language they do not understand.

Securus will also provide durable printed dialing instructions at each inmate telephone location in English, Spanish, and the other languages specified by DOCCS. As a security measure, Securus will use materials and techniques appropriate for the corrections environment that explains the process in a clearly defined and easy to read manner.

3.4.13 ANI Verification

The vendor shall test all inmate telephones for location accuracy and verify the Automatic Number Identifier (ANI) at implementation, during activation of new equipment and at a minimum, annually thereafter.

SECURUS HAS READ, AGREES AND WILL COMPLY WITH THIS REQUIREMENT.

3.4.14 Telecommunications Relay Services for the Deaf

The vendor shall provide telecommunications relay devices for the deaf compliant with the Americans with Disability Act (ADA), and the Federal Communications Commission (FCC) and New York State Public Service Commission's (PSC) rules and regulations throughout the term of the agreement.

Explain how your solution can extend telecommunications services for inmates who are deaf or hard of hearing and all monitoring, recording and reporting capabilities that will be available with this service. Include details that show how the proposed plan will be in compliance with the ADA, the FCC and PSC rules and regulations at no additional cost to DOCCS or the account holders throughout the term of the agreement, recognizing that TTY technology will cease to be supported during the term of this agreement.



SECURUS HAS READ, AGREES AND WILL COMPLY WITH THIS REQUIREMENT.

Securus will provide accommodations necessary to comply with the Americans with Disabilities Act (ADA). The Securus program for inmates who are deaf or hearing impaired allows those inmates to place outgoing telephone calls using a text telephone (TTY) device integrated with SCP.

Securus will provide accommodations necessary to comply with the Americans with Disabilities Act (ADA). The Securus program for inmates who are deaf or hearing impaired allows those inmates to place outgoing telephone calls using a text telephone (TTY) device integrated with SCP.

TDD and TTY Telephones

The technology provided uses dedicated ports on the SCP system and eliminates the need for a correctional officer or staff member initiating the call process. The inmate placing the handset on the TTY device and entering the speed-dial number initiates the call. The inmate then communicates using the TTY device through the Securus SCP to the state's telecommunication relay center (TRS). The information includes the option of including the inmate's PIN, along with a pre-set toll-free number that is direct-dialed to the TRS. With TRS, a special operator communicates back to the inmate to confirm the connection and begins the call connection process to the called party who receives the call on a collect basis.

Integrating the TTY call through SCP allows the facility to specify various policy and security measures such as time limits, call recording, remote printing of the content of the calls, redial

prevention and more. With TRS, a special operator communicates back to the inmate to confirm the connection and begins the call connection process to the called party. Charges to the called party will be rated and billed by the relay service provider.

Inmate Call Flow Using TTY to Voice

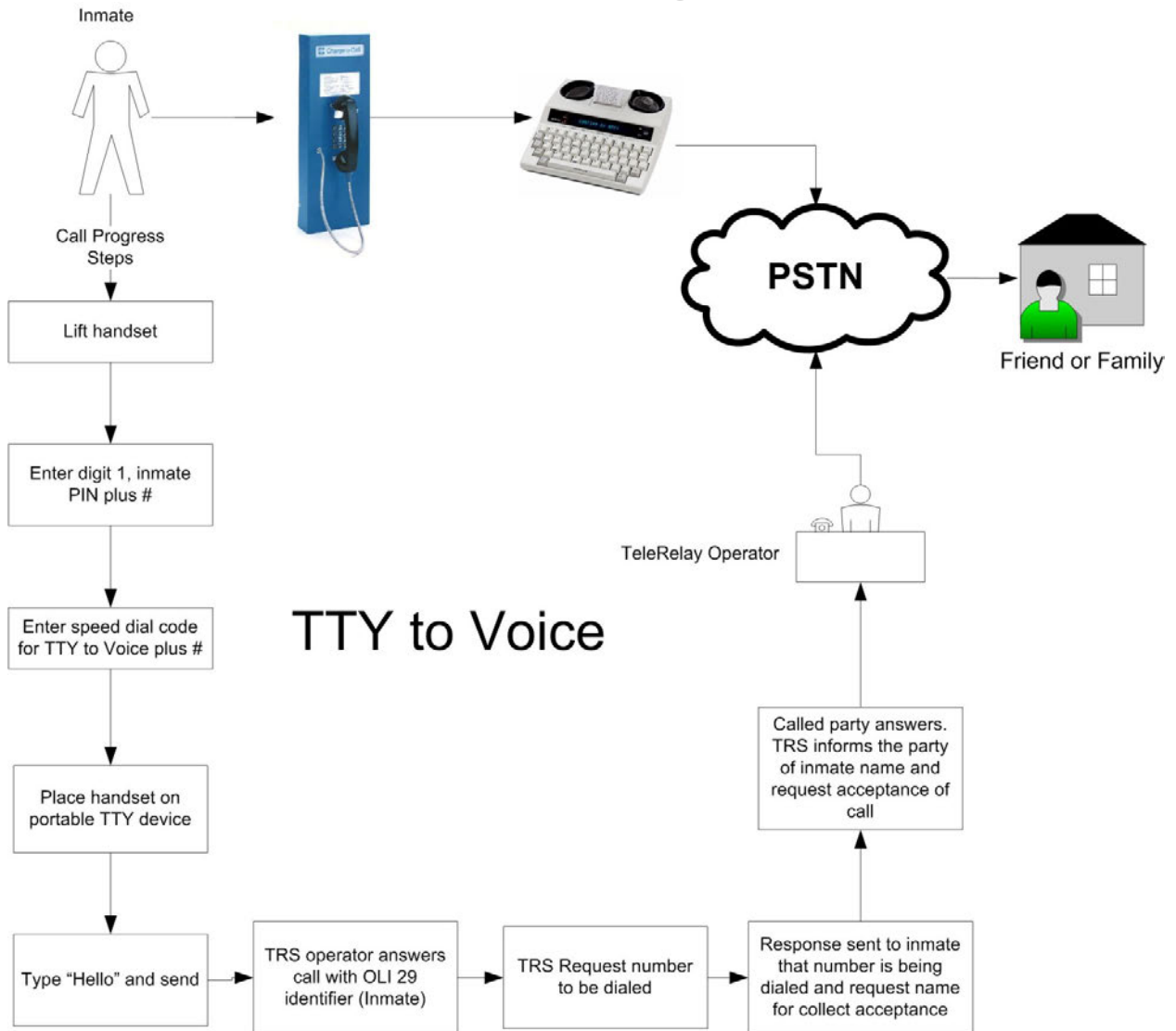

The following is a letter citing Securus' enrollment effort provided by Ms. Hazel Jennings, Bureau Chief of Facility Operations, New York Department of Corrections. Ms. Jennings can be reached at phone: 718.546.8000 for any discussion of the enrollment process.



NEW YORK CITY DEPARTMENT OF CORRECTION
Joseph Ponte, Commissioner
Hazel Jennings, Bureau Chief of Facility Operations
20 Mandanici Road
East Elmhurst, NY 11370
718 • 546 • 8000
Fax 718 • 546 • 8048

April 12, 2016

Isaac Simmons, MBA
Software Implementation Specialist
Securus Technologies
14651 Dallas Parkway, 6th Floor
Dallas, TX 75254

Mr. Simmons,

I would like to take a moment to personally thank you and your staff for your outstanding work on the installation and implementation of the Telephone Voice Biometric System for our agency.

The initial attempt was a challenge to coordinate especially when coordinating communication and scheduling of staff and inmates. Nevertheless, you and your staff, once given proper guidelines, took up the challenge and completed the project ahead of the projected completion time with professional diligence and efficiency.

Since the completion, the Telephone Voice Biometric System has been operating without incident. In addition, the reporting data has enhanced our agency's proactive measures in monitoring and deterring the incidence of contraband in our facilities. Furthermore, the reports generated by your company are relevant and essential in providing the necessary managerial statistical information required by our agency.

The Department of Correction applauds Securus Technologies for the quality of service received and the depth of knowledge and professionalism demonstrated by you and your staff.

As such, I, on behalf of the Department of Correction, would have no hesitation in using your service again or in recommending your company to others. If you wish to discuss this further, please feel free to call me.

Sincerely,

A handwritten signature in cursive script that reads "Hazel Jennings".

Hazel Jennings, Bureau Chief

Visit NEW YORK'S BOLDEST on the Web at: www.nyc.gov/boldest

For a clearer picture of the Two Enrollment Methodologies, please review the chart below:

Methodology Considerations	Unsupervised Enrollment – Option 1	Supervised Enrollment – Option 2
Ease of enrollment:	Least initial involvement by DOCCS.	Securus plans, implements, and conducts the entire enrollment with minimal impact on DOCCS, by providing organization and manpower resources to enroll the entire general population.
Cost of enrollment:	No up-front or follow-on cost to DOCCS, but if even a small number of the 50K+ inmates don't voluntarily enroll or have difficulty doing so, then DOCCS will have to continually expend its resources on an ongoing basis to identify which inmates haven't enrolled and get them to enroll so that they can make phone calls – an additional administrative burden.	Securus will absorb the cost of the initial enrollment of the general population.
Confidence in the integrity of the enrolled voice database:	<p>Low, for two reasons:</p> <ul style="list-style-type: none"> • There is no way to verify that the recording of the inmate's voice is accurate for the inmate's PIN and name (some inmates will try to circumvent enrollment for nefarious or fun-making reasons or will flat out refuse to enroll.) This makes call control by voice, and future call investigative results difficult to substantiate in court for evidentiary use. • There is no way to determine if all inmates 	<ul style="list-style-type: none"> • High confidence level in enrollment accuracy. Since the Securus enrollers validate each inmate via their picture ID and PIN against DOCCS's daily facility roster, there is a confirmed match to all of the inmates' enrolled voices. This will give a high level of confidence to DOCCS's investigators when performing call-based investigations by inmate voice print and name. • Because all inmate enrollment is confirmed and <i>IPRO</i> retains their voice prints

	<p>have enrolled. Individual follow up to achieve total enrollment by DOCCS could be costly and time consuming.</p> <ul style="list-style-type: none"> • For released inmates without a voice print, the system won't be able to determine their status and identify them by name if they become a called party to a current inmate. 	<p>after their release, <i>IPRO</i> can later determine and identify an inmate by name should that inmate become a called party to a current inmate.</p>
--	---	--

Securus is offering DOCCS the option of either of the two above-described enrollment methodologies. Either choice will be at no cost to DOCCS.

3.4.18 Emergency Shut Down

The system shall provide for the emergency shutdown of all phones in a facility or portion thereof at each facility and provide a master control in Central Office that cannot be overridden at a facility. Therefore, the system shall provide the ability to disconnect any phone or group of phones locally or remotely.

Describe in detail how this is accomplished.

SECURUS HAS READ, AGREES AND WILL COMPLY WITH THIS REQUIREMENT.

There are three ways to shut down phones:

- 1) Standard approach via software:
Use SCP UI to “disable” a facility’s phone system. Access to this can be limited through permissions so that only authorized personnel in Central Office can disable the phones and thus prevent facility staff from restoring the phones.

- 2) Standard approach via hardware:
“Kill switches” are commonly installed in strategic locations for a facility. However, data backhauls typically run from each facility to Securus. Providing a “kill switch” that can be used by the Central Office and not overridden by the facility would require that all facility traffic flows through the Central Office – NOT RECOMMENDED.

- 3) Non-conventional approach via software:
This option allows facilities to use the standard software disable so as to respond to urgent, local issues while still providing the Central Office with a software “disable” function. Define a call schedule with no call times available and set to “hard” cutoff. To disable a facility or part of a facility, assign the site (or portion of the site) with this call schedule. Access to manage call schedules can be limited through permissions so that

only authorized personnel in Central Office can set the Call Schedule and thus prevent facility staff from restoring the phones.

The Securus Secure Call Platform (SCP) provides complete flexibility to disable telephone use at any time of day through manual, or emergency, intervention or preset calling schedules.

On/Off Station Control

SCP allows authorized users to disable a telephone, group of telephones, or all facility phones using any personal computer with access to the Internet. Securus is one of the only providers to offer this capability anytime, from anywhere, 24 hours a day, seven days a week. This function allows authorized users to either kill the call immediately or allow current calls to finish while not allowing any new calls.

Disabling Telephones

The screenshot displays the Securus web interface for configuring telephones. At the top, there is a navigation menu with options: HOME, SYSTEM, MONITOR, TOOLS, ADMIN, and FACILITY PORTAL. Below this is a 'MANAGEMENT LEVEL' section with a table:

Facility	Site	Phone Group	Phone
Securus Demo Site	Kellway Test Lab Allen	All Phone Groups	All Phones

Below the table are tabs for 'General', 'Global Lists', 'Call Schedules', 'Call Forwards', 'Phone Groups', and 'Virtual Groups'. The 'General' tab is active, showing 'GENERAL SITE INFORMATION'. The configuration form includes the following fields:

- Name: Kellway Test Lab Allen
- Status: **Enable** (dropdown menu with 'Disable' option highlighted)
- Maximum Call Duration: Maximum allowed: 60 minutes
- Call Schedule: None Selected
- 3-Way Call Detection: ENABLED
- RCF Detection: ENABLED
- RCFD Action: ---
- Calling Restrictions: None Selected
- Voice Biometric: DEFAULT

At the bottom of the form are 'Update' and 'Cancel' buttons. Arrows from the 'Call Schedules', 'Call Forwards', and 'Phone Groups' tabs point to the configuration form.

3.5 Equipment

The vendor shall provide all equipment required to provide ITS services for all of the DOCCS' facilities and locations at no cost to DOCCS. All equipment must be described in the vendor's proposal. The vendor must propose equipment that is appropriate for a correctional facility environment. Upon successful installation, all telephones, pedestals, and wiring will become the property of DOCCS.

SECURUS HAS READ, AGREES AND WILL COMPLY WITH THIS REQUIREMENT.

3.5.1 Telephones

All devices provided must be hearing aid compatible and include volume controls on the housing with a 24-inch hand set cable, and be appropriate for a correctional facility environment. The devices provided must be equivalent to or better than the currently installed devices which are Wintel - Tall Blue with Volume Ctrl & 24-inch Cord Duraclear handset. At its sole discretion, DOCCS may direct the reuse or replacement of currently installed telephones at some or all locations.

SECURUS HAS READ, AGREES AND WILL COMPLY WITH THIS REQUIREMENT.

Securus' inmate telephones are the strongest and most reliable units available and are designed specifically for the prison environment. Securus is proposing Wintel® brand 5042 phone model. The following information is the manufacturer-provided telephone specifications.

The Industry Standard

These phones are the overwhelming choice for state prison systems, the Federal Bureau of Prisons, county, and city facilities nationwide because of their proven reliability, durability, and flexibility.

Features/Options

The proposed phone models include the following features:

- All-in-one electronic dial features modular incoming line and handset connections for quick maintenance. Carbon (HS) and DuraClear® (DURA) Handsets have separate 4-pin connections.
- Powder-coated cold rolled steel provides rugged vandal resistant telephone housing designed and built for inmate use
- Confidencer technology, built into every dial, filters out background noise at the user's location, allowing better sound to the called party
- Heavy chrome metal keypad bezel, buttons, and hook switch lever withstand abuse and vandalism
- Armored handset cord is equipped with a steel lanyard (1000# pull strength) and secured with a 14 gauge retainer bracket for maximum vandal resistance
- Handset has sealed transmitter and receiver caps, suitable for heavy use and abuse locations
- Pin-in-head security screws minimize tampering
- US: 1DATE05BITC-254, IC: 3267A-ITC254



3.5.2 Portable Phones

The vendor shall provide portable (wired) phones that plug into standard jacks as required. At its sole discretion, DOCCS may direct the reuse or replacement of currently installed portable telephones at some or all locations.

SECURUS HAS READ, AGREES AND WILL COMPLY WITH THIS REQUIREMENT.

Securus will also provide a roll-away phone mounted to a roll-around pedestal, in a four-wheel design or a two-wheel design, as shown.

The phone can also be mounted to a hand truck (dolly).



3.5.3 Pedestal and Enclosures

The vendor must provide pedestals as specified by DOCCS for both inside and outside locations at DOCCS' direction. At its sole discretion, DOCCS may direct the reuse or replacement of currently installed pedestals and enclosures at some or all locations.

SECURUS HAS READ, AGREES AND WILL COMPLY WITH THIS REQUIREMENT.

3.5.4 Tablets

The vendor's solution must provide tablets (tablet) for a portion of the Department's specialty populations such as Special Housing Units and Regional Mental Health Unit, etc. (approximately 5,000) to allow inmates to complete telephone calls via the tablet from their cell. Telephone calls completed via tablets must conform to all requirements and mandatory features of this RFP. Further, the tablets must provide a variety of off-line entertainment, as well as educational and religious content that is age-appropriate for a complete range of academic capabilities (see Attachment E). The successful bidder will work with DOCCS to finalize this content for the tablets.

SECURUS HAS READ, AGREES AND WILL COMPLY WITH THIS REQUIREMENT.

Securus is pleased to exceed this requirement for tablets for DOCCS by offering not 5000, but 12,000 tablets pre-loaded with the required content. In addition, this proposal includes the provision of **two (2) full-time tablet administrators** to facilitate the tablet program at the direction of DOCCS. Securus believes in the importance of education for inmates and the positive impact that it has on morale, self-worth and recidivism. That is why we are going the extra mile to

help DOCCS deliver the best inmate educational programs in the country. Please see the specific details for our tablet offerings in the response to specifications below.

3.5.4.1 Device Specifications

The vendor-provided tablets must conform, at a minimum, to the following:

- High-quality construction with a shatter-resistant and tamper-proof housing
- A 7" to 10" touch screen
- Sound limited to included earbuds only
- An internal, rechargeable, non-removable battery
- No camera
- User anonymity: no sign-on required to access preloaded content
- Content in Spanish (or language translation capabilities)
- No ability for inmates to download any content; devices must have preloaded content; DOCCS administrators must have the ability to add/remove content
- No ability to connect to any wireless network, except the ITS
- **At the Bidders' Conference, provide a sample tablet for DOCCS review of the durability and suitability for use in a secure environment.**
 - If rejected, each vendor will have the opportunity to provide an alternative device prior to RFP evaluation.

SECURUS HAS READ, AGREES AND WILL COMPLY WITH THIS REQUIREMENT.

The vendor's proposal must address the following:

- **Describe how the proposed solution will operate.**

SECURUS HAS READ, AGREES AND WILL COMPLY WITH THIS REQUIREMENT.

JPay/Securus will configure and load each tablet with the agreed-upon content and deliver the specified number of tablets to DOCCS. The tablets will be configured to access the ITS wireless network in order to use the tablet-based phone app. Upon delivery, no other network access/activity will be possible and the tablets will not be able to access any other networks. In the future, JPay can modify the tablets to access our secure wireless network if one is eventually installed. The tablets will not require traditional authentication in order to operate; however, the phone app will require users to log in to be able to access their phone account.

- **Detail the secure network to be provided for phone services through the tablets.**

SECURUS HAS READ, AGREES AND WILL COMPLY WITH THIS REQUIREMENT.

All calling features and security restrictions of Securus' inmate telephone system are passed through to the tablet, such as required PIN entry and continuous voice biometric identification throughout a call. Calls are recorded and all tablet communications are available for live

monitoring. All Securus/JPay Telephone and Tablet secure network functionality is specific to our SCP telephone system.

- **Provide details of the device to be provided.**



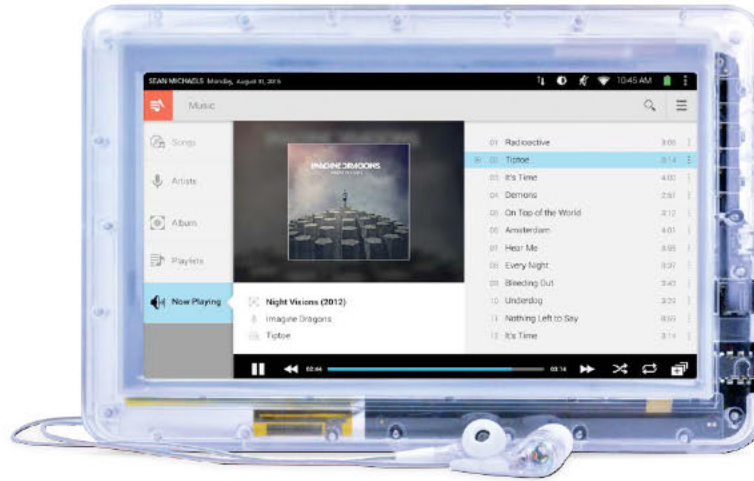

SECURUS HAS READ, AGREES AND WILL COMPLY WITH THIS REQUIREMENT.



JPay's pre-loaded 7-inch tablet, the JP55, allows inmates access to modern consumer technology they can use in throughout the facility, as opposed to via a kiosk. JPay has more than 110,000 tablets currently in use throughout 13 state DOCs. They feature high quality construction with a shatter resistant, tamper-proof housing.

The JP55 is powered by a rechargeable, non-removable lithium power pack. Included with the tablet are clear plastic earbuds and a clear protective cover. For maximum security, the tablet has no camera or internet access capability.

The JP55 comes standard with 16GB of storage capacity and has the option for more. Inmates use the tablets to listen to music, listen to the radio, play games, read eBooks and more. Main functions/features of the tablet are:

	<p>Education Access preloaded educational content</p>		<p>eBooks Read selected eBooks</p>
	<p>Music Listen to a selection of pre-loaded titles</p>		<p>Core Functions Clock, Calendar, Calculator, FM Radio and PDF Viewer included in all players</p>

	<p>Games Play a pre-loaded selection of exciting, engaging games</p>		
---	---	--	--

JP5S Tablet Specifications

- 4mm clear impact-resistant polycarbonate shell with raised edges for impact absorption
- 7" capacitive multi-touch panel with a 1024x600 screen resolution
- High strength, impact-resistant security glass with integrated screen protector
- Quad core 1.5 Ghz processor
- 1 GB RAM
- 16 GB onboard storage
- Integrated RFID for device tracking
- Only runs approved applications (server-configured)
- Barrel-shaped power port for connection to a secure 40-station charging cart

Key Features

- Text To Speech** - JPay tablets have a built-in text-to-speech capability that essentially transforms eBooks into audio books, which is ideal for inmates with literacy limitations.
- Horizontal or Vertical Viewing** - The screen can be read horizontally or vertically, depending on the inmate’s preference.
- Dimmer** - The backlight dims to avoid annoying others and ease the strain on the user's eyes.
- Selectable Background Color** - Several background colors are available, including black, which improves readability for vision-impaired users.
- Document Viewer** - Enables the player to display any downloaded or pre-installed content in Portable Document Format (PDF) such as facility handbooks, facility-specific or statewide announcements, and any other agency content DOCCS would like to distribute.

Security

JPay’s JP5 tablets use a highly secure version of the Android OS, complete with seven layers of software security including a secure (locked) bootloader, secure Linux kernel, mortality timer and a unique RFID. Hardware security features include a corrections-grade logic board and a highly secure USB port. For any content to be loaded to the player, it must be digitally “signed” by JPay, making illegal content a non-issue.

- **Demonstrate that you can meet the minimal standards for entertainment, educational, and religious content. See Attachment E.**

SECURUS HAS READ, AGREES AND WILL COMPLY WITH THIS REQUIREMENT.

As part of an existing pilot program JPay is now working on with DOCCS, the entertainment, educational, and religious content we proposed for inclusion on the JP5 tablet has already been approved by DOCCS.

- **Describe how DOCCS will be able to add/remove content as necessary.**

SECURUS HAS READ, AGREES AND WILL COMPLY WITH THIS REQUIREMENT.

Securus and JPay will work with the DOCCS to assist in the development and addition of customized DOCCS content to be added to our Tablet platform throughout the term of the agreement. We will regularly provide overviews of content added for other customers to allow the DOCCS to decide if the additional solutions are right for them.

Our solution is expandable and can upload, store, and display authorized documents in PDF format. Content is therefore unrestricted and can be used for facility handbooks, announcements, and other DOCCS publications.

For modifications, additions or deletions to the initial preloaded content, DOCCS would simply contact us with the requested changes and we would accommodate accordingly. This way, DOCCS would not have to deal with configuration control and content distribution issues.

- **Provide details of the solution that will prohibit online access.**

SECURUS HAS READ, AGREES AND WILL COMPLY WITH THIS REQUIREMENT.

JPay has customized the Linux kernel inside Android to provide unprecedented security. It blocks all devices and networks not whitelisted by JPay, so that only JPay-approved devices and networks are recognized.

JPay has also customized the Android OS so that, by default, Android applications and services are blocked. In order to add an application to the tablet, the application must first be added to the white-list of Android applications. JPay also removed the Android Debugger (ADB).

3.5.5 Wiring

The vendor is responsible for the installation and maintenance of all ITS wiring from the Intermediate Distribution Frame (IDF) to the telephone and/or wireless tablet instruments. Category 3 or better cabling is required. At its sole discretion, DOCCS may direct the reuse or replacement of current wiring at some or all locations. All wiring and cabling shall be performed in accordance with manufacturer standards and guidelines and industry practices. All installations shall be labeled and documented as mutually agreed upon between DOCCS and the vendor.

SECURUS HAS READ, AGREES AND WILL COMPLY WITH THIS REQUIREMENT.

3.5.6 Compliance

All equipment, wiring and component installations shall conform to all applicable building codes, electric codes and accepted industry standards.

SECURUS HAS READ, AGREES AND WILL COMPLY WITH THIS REQUIREMENT.

3.5.7 Restoration of Facilities

The contractor shall restore all damaged walls, ceiling and facilities to their original condition and in compliance with all applicable building codes and requirements resulting from contractor actions and activities. All work must be pre-approved by DOCCS.

SECURUS HAS READ, AGREES AND WILL COMPLY WITH THIS REQUIREMENT.

3.5.8 Inventory

The vendor must maintain a current inventory of all equipment and components and provide the inventory to DOCCS as requested.

Provide a sample inventory report with the proposal.

SECURUS HAS READ, AGREES AND WILL COMPLY WITH THIS REQUIREMENT.

Site Equipment Overview

Date		Ticket #		Installed by	
Revised Date				Revised by	
Facility Information					
Site			Site ID		Time Zone
Address					
City					
State			Zip Code		
Site Contact			Phone Number		
Email Address:					
Alt. Contact			Phone Number		
Email Address:					
IT Contact			Phone Number		
Email Address:					
Phone and Port Counts					
# of Inmate Phones		# Cart Phones:		# Cordless Phones	
# of Inmate Phone Ports		# Cart Phone Ports Used		# Cordless Phone Ports Used	
# TTY Phones		# of M/R Visit Phones		# Coin Phones	
# TTY Ports on system		# of M/R Visit Phone Ports			
Total # Phones	0	Total # Used Ports	0	Total # Visit Phones	0
(F9 to calculate phone counts)					
Visitation Phone Information					
Phone Type		Backup Visitation Installed		Pins	
VPM Type		# Sets		Pin Length	
Recorded		HS Length		Call Duration	
VPM Server Asset Tag					
Features			Switch Information		
PINS		Model		Model	
# of Digits		Asset Tag		Asset Tag	
PAN		VLAN		VLAN	
3-Way Detect		Location		Location	
Debit		IP		IP	
Cutoff Switch Information					
Type		Model		Model	
Relay Model		Asset Tag		Asset Tag	
Power Supply		VLAN		VLAN	
Type Switch		Location		Location	
Location		IP		IP	
UPS Information					
Make		Make		Make	
Model		Model		Model	
UPS Install Date		UPS Install Date		UPS Install Date	
Battery Replacement Date		Battery Replacement Date		Battery Replacement Date	
Location		Location		Location	
SCP System Information				Notes Section	
Adtran	Equipment Type	Asset Tag	Serial Number		
1					
2					
3					
4					
5					
6					
7					
8					
9					
10					
11					
12					
13					
14					
15					
16					
17					
18					
19					
20					

Station Assignments							
Port	Phone Location	MPG	On-Off Times	Ph Type	HS Length	Dial Type	How Mounted
1							
2							
3							
4							
5							
6							
7							
8							
9							
10							
11							
12							
13							
14							
15							
16							
17							
18							
19							
20							
21							
22							
23							
24							
Port	Phone Location	MPG	On-Off Times	Ph Type	HS Length	Dial Type	How Mounted
25							
26							
27							
28							
29							
30							
31							
32							
33							
34							
35							
36							
37							
38							
39							
40							
41							
42							
43							
44							
45							
46							
47							
48							

Station Assignments

Circuit Information

DMARC and IDF Information		City	State and Zip Code
Demarc Address		Street	
Bldg			
Floor			
Room			
↓ # no Room #, give detailed information on location (behind booking desk, in telco room in basement, etc.) ↓			
IDF Locations			
List location, installed equipment or anything else you feel is important.			
IDF # 1			
IDF # 2			
IDF # 3			
IDF # 4			
IDF # 5			
IDF # 6			
IDF # 7			
IDF # 8			
IDF # 9			
IDF # 10			
Choose circuit type : Cable / DSL →			
Provider	Provider Contact #	Provider	Provider
Modem Model	Modem Model	Modem Model	Modem Model
Modem MAC Address	Modem MAC Address	Modem MAC Address	Modem MAC Address
Local ANI	Local ANI	Local ANI	Local ANI
Provider IP	Provider IP	Provider IP	Provider IP
Default Gateway	Default Gateway	Default Gateway	Default Gateway
Local Eth IP	Local Eth IP	Local Eth IP	Local Eth IP
Local Subnet Mask	Local Subnet Mask	Local Subnet Mask	Local Subnet Mask
Remote Access Username	Remote Access Username	Remote Access Username	Remote Access Username
Remote Access Password	Remote Access Password	Remote Access Password	Remote Access Password
Speed	Speed	Speed	Speed
Concentrator	Concentrator	Concentrator	Concentrator
Bridged (Yes or No)	Bridged (Yes or No)	Bridged (Yes or No)	Bridged (Yes or No)
Provider	Provider	Provider	Provider
Provider Contact #	Provider Contact #	Provider Contact #	Provider Contact #
Modem Model	Modem Model	Modem Model	Modem Model
Modem MAC Address	Modem MAC Address	Modem MAC Address	Modem MAC Address
Local ANI	Local ANI	Local ANI	Local ANI
Provider IP	Provider IP	Provider IP	Provider IP
Default Gateway	Default Gateway	Default Gateway	Default Gateway
Local Eth IP	Local Eth IP	Local Eth IP	Local Eth IP
Local Subnet Mask	Local Subnet Mask	Local Subnet Mask	Local Subnet Mask
Remote Access Username	Remote Access Username	Remote Access Username	Remote Access Username
Remote Access Password	Remote Access Password	Remote Access Password	Remote Access Password
Speed	Speed	Speed	Speed
Concentrator	Concentrator	Concentrator	Concentrator
Additional Circuit Information			
MIS T1 Provider Ckt ID	MIS T1 Provider Ckt ID	MIS T1 Provider Ckt ID	MIS T1 Provider Ckt ID
MIS T1 LEC Ckt ID	MIS T1 LEC Ckt ID	MIS T1 LEC Ckt ID	MIS T1 LEC Ckt ID
Provider IP	Provider IP	Provider IP	Provider IP
Default Gateway	Default Gateway	Default Gateway	Default Gateway
Local Eth IP	Local Eth IP	Local Eth IP	Local Eth IP
Local Subnet Mask	Local Subnet Mask	Local Subnet Mask	Local Subnet Mask
MPLS T1 Provider Ckt ID	MPLS T1 Provider Ckt ID	MPLS T1 Provider Ckt ID	MPLS T1 Provider Ckt ID
MPLS T1 LEC Ckt ID	MPLS T1 LEC Ckt ID	MPLS T1 LEC Ckt ID	MPLS T1 LEC Ckt ID
Provider IP	Provider IP	Provider IP	Provider IP
Default Gateway	Default Gateway	Default Gateway	Default Gateway
Local Eth IP	Local Eth IP	Local Eth IP	Local Eth IP
Local Subnet Mask	Local Subnet Mask	Local Subnet Mask	Local Subnet Mask
MPLS T1 Provider Ckt ID	MPLS T1 Provider Ckt ID	MPLS T1 Provider Ckt ID	MPLS T1 Provider Ckt ID
MPLS T1 LEC Ckt ID	MPLS T1 LEC Ckt ID	MPLS T1 LEC Ckt ID	MPLS T1 LEC Ckt ID
Provider IP	Provider IP	Provider IP	Provider IP
Default Gateway	Default Gateway	Default Gateway	Default Gateway
Local Eth IP	Local Eth IP	Local Eth IP	Local Eth IP
Local Subnet Mask	Local Subnet Mask	Local Subnet Mask	Local Subnet Mask

Combined Transport

Direct Ethernet Circuit

Provider

Provider Contact #

Local ANI

Provider DNS # 1

Provider DNS # 2

Circuit ID

ISP Circuit ID

Router WAN IP

Customer WAN IP

Static IP Block

LAN Gateway

Local Eth IP

Local Subnet

Speed

Concentrator

Handoff

Additional Circuit Information

MIS T1 Provider Ckt ID

MIS T1 LEC Ckt ID

Provider IP

Default Gateway

Local Eth IP

Local Subnet Mask

MPLS T1 Provider Ckt ID

MPLS T1 LEC Ckt ID

Provider IP

Default Gateway

Local Eth IP

Local Subnet Mask

MPLS T1 Provider Ckt ID

MPLS T1 LEC Ckt ID

Provider IP

Default Gateway

Local Eth IP

Local Subnet Mask

New Install and Upgrade Checklist

Site Name:	Ticket #:	Comments
#	YES/NO/NA	
1		
2		
3		
4		
5		
6		
7		
8		
9		
10		
11		
12		
13		
14		
15		
16		
17		
18		
19		
20		
21		
22		

Overall Comments

--	--

Certified by (Installer): _____

Date: _____

Site Equipment Overview

Date	Ticket #	Installed by	
Revised Date		Revised by	
Facility Information			
Site	Site ID	Time Zone	
Address			
City	State	Zip Code	
Site Contact	Phone Number		
Email Address:			
Alt. Contact	Phone Number		
Email Address:			
IT Contact	Phone Number		
Email Address:			
Phone and Port Counts			
# of Inmate Phones	# Cart Phones:	# Cordless Phones	
# of Inmate Phone Ports	# Cart Phone Ports Used	# Cordless Phone Ports Used	
# TTY Phones	# of M/R Visit Phones	# Coin Phones	
# TTY Ports on system	# of M/R Visit Phone Ports		
Total # Phones	Total # Used Ports	Total # Visit Phones	
0	0	0	
(F9 to calculate phone counts)			
Visitation Phone Information			
Phone Type	Backup Visitation Installed	Pins	
VPM Type	# Sets	Pin Length	
Recorded	HS Length	Call Duration	
VPM Server Asset Tag			
Features		Switch Information	
PINS	Model	Model	
# of Digits	Asset Tag	Asset Tag	
PAN	VLAN	VLAN	
3-Way Detect	Location	Location	
Debit	IP	IP	
Cutoff Switch Information			
Type	Model	Model	
Relay Model	Asset Tag	Asset Tag	
Power Supply	VLAN	VLAN	
Type Switch	Location	Location	
Location	IP	IP	
UPS Information			
Make	Make	Make	
Model	Model	Model	
UPS Install Date	UPS Install Date	UPS Install Date	
Battery Replacement Date	Battery Replacement Date	Battery Replacement Date	
Location	Location	Location	
SCP System Information			
Notes Section			
Adtran	Equipment Type	Asset Tag	Serial Number
1			
2			
3			
4			
5			
6			
7			
8			
9			
10			
11			
12			
13			
14			
15			
16			
17			
18			
19			
20			

multiplexers, channel banks, gateways, switches or any required system component shall be new.

Provide full specifications and product literature/brochures for all proposed new components.

SECURUS HAS READ, AGREES AND WILL COMPLY WITH THIS REQUIREMENT.

Please see section/tab – REQUESTED DOCUMENTS (page 531)

3.6 Software Enhancements and Upgrades

The vendor shall provide software enhancements and upgrades for either proprietary or third-party software required by the proposed Inmate Telephone System (ITS), including wireless tablets, when the enhancement and upgrades are generally available in a customer production environment. The vendor shall be responsible for maintaining the installed ITS at the latest general release of the system software for all systems including the system administration or system reporting terminals/PCs. The vendor must upgrade or replace all third-party software and/or hardware prior to any end-of-support date set by the third-party provider. All software changes shall be preapproved by DOCCS and must utilize approved change management procedures and configuration management processes as defined under *Configuration Management* in [Section 3.2.2](#).

Provide complete documentation for all software upgrades or enhancements.

SECURUS HAS READ, AGREES AND WILL COMPLY WITH THIS REQUIREMENT.

The Securus solutions proposed will be implemented at the latest general availability release, eliminating the need for Upgrade or Enhancement documentation at the outset. However, as the contract term progresses all required documentation for all proposed systems will be provided for DOCCS preapproval and authorization. Each update will follow the strict change control methodology as outlined in section 3.11.1 of this proposal as well as the processes as defined under Configuration Management in Section 3.2.2.

Software Upgrades

We recognize that the challenges you and your officers face every day never stop evolving. When designed our centralized platform, one of our chief objectives was deploying a system that provided upgrades to all customers at regular intervals with no downtime. We achieved that objective with SCP. Securus provides upgrades to all of our customers three to four times annually through a proven and tested after hours process that allows all sites to immediately realize the benefits each upgrade. Our system delivers proven features driven by input from the most recognized corrections and law enforcement agencies in the nation.

Maintenance events are always preceded by a splash screen displayed at login notifying the facility of the upcoming upgrade and new features are discussed with customers prior to implementation. These system updates are more than simple changes. They provide meaningful features and new capabilities, which drive greater officer and community safety, staff efficiency and improved investigative response times.

The following image shows the sample splash screen that notifies users of upcoming maintenance.

Splash Screen



[Terms and Conditions](#)
© 2005, 2011, 2016 Securus Technologies, Inc. All Rights Reserved.

3.7 Maintenance

The vendor shall be solely responsible for the maintenance and support for all system components including telephones, pedestals, enclosures, circuits, network components, software, call processors and all other elements of the system.

Describe the maintenance and support capabilities, methods and procedures as related to the subsections below.

SECURUS HAS READ, AGREES AND WILL COMPLY WITH THIS REQUIREMENT.

Securus provides superior customer service from a state-of-the-art operations center located in Carrollton, Texas. More than 50 technicians staff the Securus Technical Support Center (TSC) to ensure prompt problem resolution. The average tenure of our support management is five years and our technicians average four years.

Securus Maintenance and Technical Support Services

The Securus TSC serves as a single point of contact for facility staff to request service **24 hours a day, seven days a week, 365 days per year**. There are four ways to contact the TSC:

- Telephone: 866-558-2323
- E-Mail: technicalsupport@securustech.net
- Fax: 800-368-3168
- Web portal @ <http://www.securustech.net/facility.asp>

The TSC uses a call distribution system to manage the flow of inbound customer calls automatically routing calls directly to our support technicians in a skills-based, platform specific manner. Securus establishes response times and service level agreements that accomplish our objective of providing timely resolution to each request.

Technicians assign each service request one of three initial priority levels, each with resolution and escalation timelines. Every effort is made to resolve the problem remotely within the designated timeframes, and Securus resolves most service requests during the initial request. If necessary, a field service technician is dispatched to the facility to expedite resolution.

The TSC uses an event tracking system that logs, tracks, manages and assures appropriate response to all service requests. The service request generates a trouble ticket with priority level assignment that drives diagnosis and response processes. The support technician performs initial problem diagnosis and isolation procedures, determines the nature of the problem and either resolves the problem or engages an appropriate party for problem resolution. The TSC retains ownership of all service requests and is responsible for the escalation and update functions.

Service Response Times and Escalations

Priority Level	Service Priority Description	Response Time	Customer Communication Guideline	Escalations
P1 DOCCS Levels 1-2	A P1 is our highest service level defined as 30% or more of the functionality of the System being adversely affected by the System Event. Examples of P1 service assignments would include items such as no voice prompts, features not operating appropriately, inability to burn CD's, issues with listening to live calls, inability to access S-Gate, all phones down.	2 hours	Securus Technical Support Center notifies the facility when the service issue is resolved If a technician is required, Securus Dispatch or Field Service Technician contacts the customer with an estimated time of arrival	If response is delayed, escalation procedures within Securus' Management Team are activated to ensure appropriate resources are allocated to resolve the service request Technical Support Manager & Field Service Manager Technical Support Director & Field Service Director VP Service & Operations
P2 DOCCS Levels 3-4	A P2 assignment defined as 5% to 29% of the functionality of the System being adversely affected by the System Event. Examples of a P2 service assignments would include items such as workstation, specific system ports, LEC circuits, unblocks, block numbers, missing CDRs, call searching.	24 hours	Securus Technical Support Center notifies the facility when the service issue is resolved If a technician is required, Securus Dispatch or Field Service Technician contacts the customer with an estimated time of arrival	If response is delayed, escalation procedures within Securus' Management Team are activated to ensure appropriate resources are allocated to resolve the service request Technical Support Manager & Field Service Manager Technical Support Director & Field Service Director VP Service & Operations
P3 DOCCS Level 5	A P3 assignment defined as less the 5% of the functionality of the System	72 hours	Securus Technical Support Center notifies	If response is delayed, escalation procedures within Securus'

	<p>being adversely affected by the System Event. Single and multiple phones related issues. Examples of P3 service assignments would include items such as static on the phone, a party not being able to hear, unable to dial, a broken phone, dial pad not working, cutoff switches not working, and inability to generate reports.</p>		<p>the facility when the service issue is resolved</p> <p>If a technician is required, Securus Dispatch or Field Service Technician contacts the customer with an estimated time of arrival</p>	<p>Management Team are activated to ensure appropriate resources are allocated to resolve the service request</p> <p>Technical Support Manager & Field Service Manager</p> <p>Technical Support Director & Field Service Director</p> <p>VP Service & Operations</p>
--	---	--	---	--

Securus employs approximately 170 field service associates including 9 Regional Managers and a centralized Field Dispatch team to support our national customer base, and also utilize a significant number of 3rd party representatives to support MBE/WBE requirements. The Field Service Technicians (FST) are strategically positioned to meet the response time requirements of our customer's and reside near each customer location. FSTs are all required to have extensive telecommunication background and are Securus-certified to service our product offerings. The FTSs have direct access to senior technical support and engineering resources to expedite repairs and minimize customer downtime.

Workflow

Once our centralized Technical support operation determines that an issue requires on-site service, our dispatch team contacts the assigned FST and establishes an estimated time of arrival. The Dispatcher or the FST immediately communicate the time of arrival to the facility. Upon arrival at the facility, the FST will meet with the primary site contact to review the problem and perform the necessary repairs. Repairs typically involve repairing or replacing a defective part or wiring or correcting configuration settings.

Upon resolving the primary issue, the Field Service Technician will perform a system check to detect any unreported issues and conduct preventative maintenance checks while on-site, including:

- Cleaning out the system filters
- Testing system features and functionality
- Testing of individual phones
- Performing workstation(s) inspections.

Problems identified during this check are addressed by the Field Service Technician during the same visit unless additional parts are required to resolve the issue.

Upon completion of the repairs, the FST will validate problem resolution with the primary site contact and obtain sign-off on the repairs performed. After obtaining sign-off, the FST will record the transaction in our problem management system through his or her laptop.

Service Parts

Securus field service technicians maintain a working level of spare parts for minor repairs consisting of telephone sets, handsets, dials, and replacement circuit boards, either on-site or in their truck. If a technician does not have required a part, Securus will drop-ship the item to the site. Securus will ship counter-to-counter on the same day in critical situations.

Quality

Securus sends an e-mail customer satisfaction survey to the primary site contact following each service event. Customer concerns are immediately escalated to the Regional Service Manager and the National Service Director. The Regional Service Manager is required to contact the customer within 24 hours to better understand the concern and implement a correct action plan. Securus executives review the summary of each issue along with the corrective actions on a monthly basis. Our current survey results show 94% satisfaction with Field Service with 77% indicating they were “delighted” with the service they received.



Implementation

Our preliminary implementation plan includes transitional meetings that detail the setup of proposed applications and tasks associated with the transition from the current system to Securus' Secure Call Platform (SCP). Securus has extensive experience preparing locations for system implementation without disrupting the facility's existing service. All hardware, phone lines, and workstations will be in place before replacing the telephone instruments and cutting over to SCP.

3.7.1 Maintenance Responsibility

Malfunctions which cannot be immediately diagnosed and pinpointed to a certain item of equipment or particular service will require the participation of all service suppliers until responsibility for the problem has been unequivocally established. As a part of maintenance responsibilities, the contractor shall represent DOCCS with the regulated telephone company, network provider, or any other third-party service provider, in order to identify and correct problems with service.

In no instance shall the failure to resolve the issue of responsibility relieve the contractor from the obligation to restore system operability with the least impact on the availability of service.

SECURUS HAS READ, AGREES AND WILL COMPLY WITH THIS REQUIREMENT.

3.7.2 Damage

The vendor shall be responsible for the repair or replacement of all equipment damaged regardless of the cause including, but not limited to, inmate damage, natural disaster, and DOCCS' actions or operations at no cost to DOCCS.

SECURUS HAS READ, AGREES AND WILL COMPLY WITH THIS REQUIREMENT.

3.7.3 Maintenance Window

All scheduled maintenance must be performed outside of the normal ITS operating hours which are currently 7:00 a.m. to 11:00 p.m. ET.

SECURUS HAS READ, AGREES AND WILL COMPLY WITH THIS REQUIREMENT.

3.7.4 Maintenance Center Location

Within 14 days of notification of selection, the vendor shall detail the location and number of maintenance staff, the staff experience, DOCCS' facilities to be supported by each location, and procedures to provide on-site maintenance service at all the DOCCS' locations with vendor provided equipment to meet DOCCS performance requirements. If the origination points for the maintenance staff are their homes, rather than a maintenance center, the staffs' origination addresses must be provided. It is a mandatory requirement of this RFP that the vendor agrees to have maintenance personnel within a three (3) hour drive from their origination addresses to each of DOCCS' locations throughout New York State. Failure to do so will result in a breach of contract. A map of the DOCCS' facility locations is provided in Attachment B.

SECURUS HAS READ, AGREES AND WILL COMPLY WITH THIS REQUIREMENT.

3.7.5 Maintenance Staff Experience

Service personnel must be trained and experienced with installation and maintenance of the proposed system and equipment. DOCCS reserves the rights to request copies of training certificates for service personnel and to reject any maintenance personnel it determines to be unqualified to perform maintenance service on the proposed equipment.

SECURUS HAS READ, AGREES AND WILL COMPLY WITH THIS REQUIREMENT.

3.7.6 Preventive Maintenance

The vendor shall conduct an on-site inspection and preventative maintenance service for all premise-based equipment provided on a quarterly basis at a minimum. The vendor shall certify the completion of the quarterly inspection and notify DOCCS of any equipment changes. Provide a sample of the proposed preventive maintenance report and certification form, including but not limited to, components to be tested, and pass/fail criteria for each component.

The proposed schedule shall be consistent with DOCCS' operating requirements and shall be based upon the specific needs of the equipment being maintained.

SECURUS HAS READ, AGREES AND WILL COMPLY WITH THIS REQUIREMENT.

3.7.7 Remedial Maintenance

DOCCS will maintain a call screening service for all facilities. All service calls will be placed by DOCCS or its agent. Facilities will have the option to call in service issues at DOCCS sole discretion. Remedial maintenance shall be performed upon notification to the vendor that the equipment/service is inoperable or unsuitable for operation. The contractor shall be responsible for assuring that on premise service for each request is provided in accordance with the DOCCS' service requirements as defined in Section 5.

SECURUS HAS READ, AGREES AND WILL COMPLY WITH THIS REQUIREMENT.

3.7.8 Maintenance Request Reports

The vendor shall furnish DOCCS with a monthly report, in a format to be determined by DOCCS, of all maintenance requests. The report shall include, at a minimum, the following data for each request for assistance:

- Date and time notified
- Date and time of arrival
- Description of malfunction reported
- Diagnosis of failure and work performed
- Date and time failure was corrected
- Name of person performing the service
- Name of person and agency reporting trouble

SECURUS HAS READ, AGREES AND WILL COMPLY WITH THIS REQUIREMENT.

3.8 Transition/Migration

The vendor shall assume responsibility for all inmate telephone services effective on a specific date to be set by DOCCS prior to the official contract award and act as the DOCCS' agent to assure uninterrupted ITS operations as of that date. The vendor shall be responsible for establishing agreements with the existing provider as required to maintain all existing services and functions. Pursuant to the previous ITS contract, the existing vendor has committed to deliver to DOCCS a Phase-Out plan 80 calendar days before contract completion or termination and to maintain contract compliance during the period of time leading up to the contract expiration of termination. During turnover of the ITS systems to the successor contractor, the incumbent will deliver an inventory of all

vendor-owned property at all DOCCS' locations and any outstanding requests/enhancements/issues to DOCCS. At DOCCS' direction, the existing vendor will turn over all vendor-provided equipment at all DOCCS' locations by close of business on the last day of the contract.

Describe the plan to migrate from the current DOCCS' ITS system to the proposed system.

SECURUS HAS READ, AGREES AND WILL COMPLY WITH THIS REQUIREMENT.

Securus has proven experience with Integration. Securus currently integrates with more than 110 different vendors worldwide and more than 60 independent, facility-owned systems and shared databases. Securus has extensive experience with migration from GTL-based systems, highlighting our recent integrations with Georgia, Arkansas, Pennsylvania, Connecticut and Missouri Department of Corrections. Please see section 3.8.1 for a complete Project Plan including Transition/Migration. (page 226)

Securus Dedicated Integration Team

Securus has a dedicated Integration Department that integrates various systems and products in the corrections environment. This dedicated Integration Department allows Securus to deliver fast and flexible solutions for our customers. The Securus technology has the flexibility to work with facility-owned systems, JMS, OMS, Commissary, Banking, and Kiosk vendors. Securus will fully cooperate with your facility and your vendors to automate systems.

The most common technologies Securus uses include SOAP Web Services, HTTP, FTP push or pull of files in any textual format, JSON, XML-RPC, and TCP Sockets. All of these methods integrate over secure connections.

Securus can modify your data format for migration into our platform, without costly code modifications. Securus integration engineers consult with facilities' IT departments or system providers to determine the best integration strategy for each specific application.

Securus Integration Process

The dedicated Securus Integration team designs, develops, tests and implements all custom integrations with corrections industry vendors and banking systems to deliver fast and flexible solutions for our customers. This process is part of the overall Project Plan for the installation of the Securus Secure Call Platform (SCP). Major milestones include:

- Collect Preliminary Needs/Requirements
- Contract Signed
- Finalized Requirements document
- Approved Scope Statement
- Finalize Design Document
- Schedule Customer Implementation

- Develop Custom Integration Solution
- Test Custom Integration Solution
- Implement Custom Integration Solution
- Customer Approval and Sign-off

PIN Generation

The Securus Secure Call Platform (SCP) enables a facility to set up Personal Identification Numbers (PINs) for each inmate. The system can be configured to require inmates to enter their PIN before making a phone call.

PIN generation can be uploaded from a OMS or Commissary provider using the Securus E-Imports application, web services or a custom integration. PINs can also be manually input through the SCP user interface.

PINs can be linked an inmate's Custody Account for all inmate information including allowed calling schedule, call durations, and more. The number can be configured as a number from 4 to 16 digits in length. Each inmate can be issued a unique PIN. A common practice for PINs is using a combination of fields, such as the last four digits of the jacket ID and the birth month and day of the inmate.

Additionally, some OMS platforms can generate a 4 to 16 digit PIN randomly and send it to SCP via an integration. This option is beneficial because it enables the booking officer to give an inmate their PIN, so they can begin making calls immediately.

PIN Operations

PIN operations through SCP are highly flexible. Facilities can enable or disable PIN operations at the facility, inmate account, or phone level. For example, facility personnel may choose to enable PIN operations for maximum security or long-term areas, and disable PIN operations for overnight, work release, or trustee areas. SCP has no limit on the number of PIN or non-PIN inmate telephones operating at the facility.

For phones programmed for PIN operations, each inmate must enter their PIN before making a telephone call. By using their PIN, they create an audit trail that shows the inmate that placed the call, the date and time of the call, and the number that called. PINs also enable facility staff to authorize or restrict specific inmates from calling specific numbers.

PIN Restrictions

PINs can be used to restrict inmate calls at the facility, phone, or inmate account level. For example, facilities can identify and lock PINs to a phone or group of phones within a facility. Site administrators also have the ability to transfer PINS, or a single PIN, when inmates change

housing units. Transferring PINs can also be automated through our Securus E-Imports application, web services or a custom integration.

OMS Integration

The Securus SCP can be integrated with a facility's offender management system (OMS) or Commissary system so that the inmate PINs are automatically transferred, activated and deactivated based on the inmate's status. If an inmate is released, the inmate's PIN is stored and can be reactivated along with call detail records and inmate recordings if the inmate returns to the facility.

Examples of fields that can be automatically populated in SCP from an OMS or Commissary integration include:

- **First Name** – Inmate's first name
- **Middle Name** – Inmate's middle name
- **Last Name** – Inmate's last name
- **Birth Date** – Inmate's date of birth
- **Social Security Number (SSN)** – Inmate social security number
- **Account Number** – Inmate's prison ID, jacket ID, or docket number, to be used as the SCP inmate custody account number. Any number permanently assigned to an inmate that does not change if they are released and booked back into the facility.
- **PIN** – 4 to 16 digit code used by the inmate to place phone calls.
- **Activate Date** – Date in which the inmate account became active in the system
- **Book Date** – Date that the inmate entered the facility
- **Gender** – Inmate gender
- **Housing** – Location of the inmate
- **Race** – Inmate race
- **Alert Level** – Typically used for security status such as maximum, minimum, low risk, and death row
- **Max Call Duration** – Call duration applied to each phone call placed by this inmate
- **Three-Way Detection** – Setting to enable or disable three-way call detection for this inmate
- **Language Preference** – Language in which the inmate speaks for reporting purposes (does not dictate the language of phone prompts)
- **Suspended** – Setting to allow or prevent the inmate from placing calls
- **Suspend Start Date** – Start date of calling privileges suspension
- **Suspend End Date** – End date of calling privileges suspension

Securus currently integrates with more than 110 vendors worldwide, including:

ABL Management, Inc.	FirsTech	PTS Solutions
Aramark	FSG Software	Sleuth
Archonix	Genesis	Southern Software
Beacon Software Solutions	Global Software	Spillman
Canteen	Golden Eagle	Stellar
CBM	Guarded Exchange	Stewart Commissary
CenturyLink	Huber & Associates	Sungard/OSSI
Circular/SecurManage	ID Networks	SunRidge Systems
CIS	Intellitech	Swanson
Cisco	Intergraph	Synergistics Software Inc.
Compass Group	J-CORR Technologies/Abbey Group	Syscon
Correctional Food Services	Justice Data Solutions	TAC-10
Correctional Food Services/ITF	Justice Software	Tech Friends
Cottrell Consulting	Keefe	Telerus
CTS America	Kimble	Telus
Cushing Technologies	Lawrence and Associates	Text and Data/JAMIN
D&D Vending	M&M Micro	Tiburon
Digitech/Jail Tracker	MoneyGram	Tiger
DSI/ITI	Netdata	Touchpay
DSSI	New World	TriTech Software Systems
Eagle Advantage	Northland IT Solutions	Trinity Services Group
edocTec	Northpoint Institute, Inc.	Turnkey
EForce	Oasis	Tyler Technologies
E-Justice/Crime Cog	Premier Supply Link	UniSys
Embarq	Prevatek	VisionAir
Emergitech	Primonics	Western Union
EnRoute 911	Pro Phoenix	Windspeed Software

3.8.1 Project Management

Submit a proposed Project Plan in Microsoft Project format. Such plan must effect full statewide implementation within the required 90-day transition period. The Plan must include at least the following elements:

- Implementation plan
- Migration plan
- Fallback plan
- Risk management and mitigation plan
- Acceptance test plan
- Training plan
- Communications plan for both the DOCCS' users and the non-DOCCS' users
- Performance and service level plan
- Project reporting process and mechanisms
- Change management process
- Configuration management plan

SECURUS HAS READ, AGREES AND WILL COMPLY WITH THIS REQUIREMENT.

Project Implementation (Pre-Installation)

PRE INSTALLATION PROJECT IMPLEMENTATION DOCUMENT SUMMARY

Securus Technologies is dedicated to precision and accuracy in our deployment procedures. To assist in our performance, Securus follows project management architecture to maintain and record the scope and performance of the implementation through the following documentation.

- Project Charter
- Project Communications Plan
- Project Risk and Issues Log
- Project Contractual Requirements Tracker

Project Charter – The Project Charter includes specific details and process procedures that are included in the scope of work of the project. Within the Project Charter, we identify the project stakeholders and the roles and responsibilities of those identified; the project mission covering the business needs and project products; duration of the installation; scope of work associated to the responsible party; full description of the out of scope items; and the constraints and risks of items which may impact the installation from its projected project plan. Stakeholder signatures are captured within the Project Charter.

Project Communications Plan – The Communications Plan will describe the method in which all communications will be supplied to the stakeholders throughout the installation. Specific details regarding the conference bridge, meeting schedule, and description of the documents which will be

used through the installation are explained. As a measure to maintain direction and focus, the plan will also describe the risk management process and change order requirements. Authorized stakeholders will be required to approve a change order to the scope of work.

Project Risk and Issues Log – The Risk and Issues Log is managed by the Project Manager during the installation. The log is maintained to track and monitor items which may cause delays. It is used to assist in driving directives to completion and generating any change controls to the scheduled operations.

Project Contractual Requirements Tracker – The Project Contractual Requirement Tracker is a record of all product and feature requirements identified in the contract which are required to be included before they can be accepted as installed.

By signing below, each stakeholder acknowledges the receipt and review of the following implementation documents and understands the scope of work which has been contractually agreed upon to be completed. Signatures have been given by those in authority to speak for the agency. Changes outside of the described procedures in the attached documents may be subject to charges accordingly.

Stakeholder Name	Signature	Date
Stakeholder Name	Signature	Date
Stakeholder Name	Signature	Date
Stakeholder Name	Signature	Date
Stakeholder Name	Signature	Date

Project Implementation Plan (60 Days)

ID	Task Name	Duration	Start	Finish
1	SECURUS Offender Calling System Installation Project Plan for New York Department of Corrections (Phased Install)	47.63 days	Wed 6/29/16	Fri 9/2/16
2	Offender Calling System Installation & Cut-Over	47.63 days	Wed 6/29/16	Fri 9/2/16
3	Project Initiation Phase	21 days	Wed 6/29/16	Wed 7/27/16
4	Welcome to Securus!	5 days	Wed 6/29/16	Tue 7/5/16
5	Upon contract execution - Securus Account Executive to call NY DOC	4 days	Wed 6/29/16	Mon 7/4/16
6	Arrange for onsite face-to-face kick-off meeting at a NY DOC location	1 day	Wed 6/29/16	Wed 6/29/16
7	Project Manager Introduction with NY DOC (conference call)	2 days	Fri 7/1/16	Mon 7/4/16
8	Identify point of contact and contact information for each correctional facility location	1 day	Fri 7/1/16	Fri 7/1/16
9	Facility address verification and telecom demarcation verification	1 day	Mon 7/4/16	Mon 7/4/16
10	Site Survey access and scheduling	1 day	Mon 7/4/16	Mon 7/4/16
11	On Site Kick-Off meeting with NY DOC & Securus Account Team	1 day	Tue 7/5/16	Tue 7/5/16
12	Review:	1 day	Tue 7/5/16	Tue 7/5/16
13	Project Team structure for Securus and NY DOC	3 hrs	Tue 7/5/16	Tue 7/5/16
14	Preliminary project plan & implementation schedule	1 hr	Tue 7/5/16	Tue 7/5/16
15	Establish meeting schedule and communication plans	1 hr	Tue 7/5/16	Tue 7/5/16
16	Integration opportunities for automated PIN/PAN data management	1 hr	Tue 7/5/16	Tue 7/5/16
17	Review field service access/scheduling & telecom vendor scheduling options	1 hr	Tue 7/5/16	Tue 7/5/16
18	Distribution of informational literature/collateral for public & Offenders	1 hr	Tue 7/5/16	Tue 7/5/16
19	Site Surveys conducted by Securus Field Services Team	16 days	Wed 7/6/16	Wed 7/27/16
20	Region 1 - Facilities	15 days	Wed 7/6/16	Tue 7/26/16
21	CAPE VINCENT CORRECTIONAL FACILITY	1 day	Wed 7/6/16	Wed 7/6/16
22	Demarc & ITS/WAP Location inspection	1 day	Wed 7/6/16	Wed 7/6/16
23	Offender Calling locations - survey	1 day	Wed 7/6/16	Wed 7/6/16
24	Environmental evaluation & testing	1 day	Wed 7/6/16	Wed 7/6/16
25	WARTOWN CORRECTIONAL FACILITY	1 day	Thu 7/7/16	Thu 7/7/16
26	Demarc & ITS/WAP Location inspection	1 day	Thu 7/7/16	Thu 7/7/16
27	Offender Calling locations - survey	1 day	Thu 7/7/16	Thu 7/7/16
28	Environmental evaluation & testing	1 day	Thu 7/7/16	Thu 7/7/16
29	GOUVERNEUR CORRECTIONAL FACILITY	1 day	Fri 7/8/16	Fri 7/8/16
30	Demarc & ITS/WAP Location inspection	1 day	Fri 7/8/16	Fri 7/8/16
31	Offender Calling locations - survey	1 day	Fri 7/8/16	Fri 7/8/16
32	Environmental evaluation & testing	1 day	Fri 7/8/16	Fri 7/8/16
33	RIVERVIEW CORRECTIONAL FACILITY	1 day	Mon 7/11/16	Mon 7/11/16
34	Demarc & ITS/WAP Location inspection	1 day	Mon 7/11/16	Mon 7/11/16
35	Offender Calling locations - survey	1 day	Mon 7/11/16	Mon 7/11/16
36	Environmental evaluation & testing	1 day	Mon 7/11/16	Mon 7/11/16

ID	Task Name	Duration	Start	Finish
37	OGDENSBURG CORRECTIONAL FACILITY	1 day	Tue 7/12/16	Tue 7/12/16
38	Demarc & ITS/WAP Location inspection	1 day	Tue 7/12/16	Tue 7/12/16
39	Offender Calling locations - survey	1 day	Tue 7/12/16	Tue 7/12/16
40	Environmental evaluation & testing	1 day	Tue 7/12/16	Tue 7/12/16
41	FRANKLIN CORRECTIONAL FACILITY	1 day	Wed 7/13/16	Wed 7/13/16
42	Demarc & ITS/WAP Location inspection	1 day	Wed 7/13/16	Wed 7/13/16
43	Offender Calling locations - survey	1 day	Wed 7/13/16	Wed 7/13/16
44	Environmental evaluation & testing	1 day	Wed 7/13/16	Wed 7/13/16
45	BARE HILL CORRECTIONAL FACILITY	1 day	Thu 7/14/16	Thu 7/14/16
46	Demarc & ITS/WAP Location inspection	1 day	Thu 7/14/16	Thu 7/14/16
47	Offender Calling locations - survey	1 day	Thu 7/14/16	Thu 7/14/16
48	Environmental evaluation & testing	1 day	Thu 7/14/16	Thu 7/14/16
49	UPSTATE CORRECTIONAL FACILITY	1 day	Fri 7/15/16	Fri 7/15/16
50	Demarc & ITS/WAP Location inspection	1 day	Fri 7/15/16	Fri 7/15/16
51	Offender Calling locations - survey	1 day	Fri 7/15/16	Fri 7/15/16
52	Environmental evaluation & testing	1 day	Fri 7/15/16	Fri 7/15/16
53	CHATEAUGAY CORRECTIONAL FACILITY	1 day	Mon 7/18/16	Mon 7/18/16
54	Demarc & ITS/WAP Location inspection	1 day	Mon 7/18/16	Mon 7/18/16
55	Offender Calling locations - survey	1 day	Mon 7/18/16	Mon 7/18/16
56	Environmental evaluation & testing	1 day	Mon 7/18/16	Mon 7/18/16
57	ALTONA CORRECTIONAL FACILITY	1 day	Tue 7/19/16	Tue 7/19/16
58	Demarc & ITS/WAP Location inspection	1 day	Tue 7/19/16	Tue 7/19/16
59	Offender Calling locations - survey	1 day	Tue 7/19/16	Tue 7/19/16
60	Environmental evaluation & testing	1 day	Tue 7/19/16	Tue 7/19/16
61	CLINTON CORRECTIONAL FACILITY	1 day	Wed 7/20/16	Wed 7/20/16
62	Demarc & ITS/WAP Location inspection	1 day	Wed 7/20/16	Wed 7/20/16
63	Offender Calling locations - survey	1 day	Wed 7/20/16	Wed 7/20/16
64	Environmental evaluation & testing	1 day	Wed 7/20/16	Wed 7/20/16
65	ADIRONDACK CORRECTIONAL FACILITY	1 day	Thu 7/21/16	Thu 7/21/16
66	Demarc & ITS/WAP Location inspection	1 day	Thu 7/21/16	Thu 7/21/16
67	Offender Calling locations - survey	1 day	Thu 7/21/16	Thu 7/21/16
68	Environmental evaluation & testing	1 day	Thu 7/21/16	Thu 7/21/16
69	MORIAH SHOCK INCARCERATION CORRECTIONAL FACILITY	1 day	Fri 7/22/16	Fri 7/22/16
70	Demarc & ITS/WAP Location inspection	1 day	Fri 7/22/16	Fri 7/22/16
71	Offender Calling locations - survey	1 day	Fri 7/22/16	Fri 7/22/16
72	Environmental evaluation & testing	1 day	Fri 7/22/16	Fri 7/22/16
73	WASHINGTON CORRECTIONAL FACILITY	1 day	Mon 7/25/16	Mon 7/25/16

ID	Task Name	Duration	Start	Finish
74	Demarc & ITS/WAP Location inspection	1 day	Mon 7/25/16	Mon 7/25/16
75	Offender Calling locations - survey	1 day	Mon 7/25/16	Mon 7/25/16
76	Environmental evaluation & testing	1 day	Mon 7/25/16	Mon 7/25/16
77	GREAT MEADOW CORRECTIONAL FACILITY	1 day	Tue 7/26/16	Tue 7/26/16
78	Demarc & ITS/WAP Location inspection	1 day	Tue 7/26/16	Tue 7/26/16
79	Offender Calling locations - survey	1 day	Tue 7/26/16	Tue 7/26/16
80	Environmental evaluation & testing	1 day	Tue 7/26/16	Tue 7/26/16
81	Region 2 - Facilities	15 days	Wed 7/6/16	Tue 7/26/16
82	WOODBOURNE CORRECTIONAL FACILITY	1 day	Wed 7/6/16	Wed 7/6/16
83	Demarc & ITS/WAP Location inspection	1 day	Wed 7/6/16	Wed 7/6/16
84	Offender Calling locations - survey	1 day	Wed 7/6/16	Wed 7/6/16
85	Environmental evaluation & testing	1 day	Wed 7/6/16	Wed 7/6/16
86	SULLIVAN CORRECTIONAL FACILITY	1 day	Thu 7/7/16	Thu 7/7/16
87	Demarc & ITS/WAP Location inspection	1 day	Thu 7/7/16	Thu 7/7/16
88	Offender Calling locations - survey	1 day	Thu 7/7/16	Thu 7/7/16
89	Environmental evaluation & testing	1 day	Thu 7/7/16	Thu 7/7/16
90	EASTERN NEW YORK CORRECTIONAL FACILITY	1 day	Thu 7/7/16	Thu 7/7/16
91	Demarc & ITS/WAP Location inspection	1 day	Fri 7/8/16	Fri 7/8/16
92	Offender Calling locations - survey	1 day	Fri 7/8/16	Fri 7/8/16
93	Environmental evaluation & testing	1 day	Fri 7/8/16	Fri 7/8/16
94	ULSTER CORRECTIONAL FACILITY	1 day	Mon 7/11/16	Mon 7/11/16
95	Demarc & ITS/WAP Location inspection	1 day	Mon 7/11/16	Mon 7/11/16
96	Offender Calling locations - survey	1 day	Mon 7/11/16	Mon 7/11/16
97	Environmental evaluation & testing	1 day	Mon 7/11/16	Mon 7/11/16
98	HUDSON CORRECTIONAL FACILITY	1 day	Tue 7/12/16	Tue 7/12/16
99	Demarc & ITS/WAP Location inspection	1 day	Tue 7/12/16	Tue 7/12/16
100	Offender Calling locations - survey	1 day	Tue 7/12/16	Tue 7/12/16
101	Environmental evaluation & testing	1 day	Tue 7/12/16	Tue 7/12/16
102	COXSACKIE CORRECTIONAL FACILITY	1 day	Wed 7/13/16	Wed 7/13/16
103	Demarc & ITS/WAP Location inspection	1 day	Wed 7/13/16	Wed 7/13/16
104	Offender Calling locations - survey	1 day	Wed 7/13/16	Wed 7/13/16
105	Environmental evaluation & testing	1 day	Wed 7/13/16	Wed 7/13/16
106	GREENE CORRECTIONAL FACILITY	1 day	Thu 7/14/16	Thu 7/14/16
107	Demarc & ITS/WAP Location inspection	1 day	Thu 7/14/16	Thu 7/14/16
108	Offender Calling locations - survey	1 day	Thu 7/14/16	Thu 7/14/16
109	Environmental evaluation & testing	1 day	Thu 7/14/16	Thu 7/14/16
110	MT MCGREGOR CORRECTIONAL FACILITY	1 day	Fri 7/15/16	Fri 7/15/16

ID	Task Name	Duration	Start	Finish
111	Demarc & ITS/WAP Location inspection	1 day	Fri 7/15/16	Fri 7/15/16
112	Offender Calling locations - survey	1 day	Fri 7/15/16	Fri 7/15/16
113	Environmental evaluation & testing	1 day	Fri 7/15/16	Fri 7/15/16
114	HALE CREEK CORRECTIONAL FACILITY	1 day	Mon 7/18/16	Mon 7/18/16
115	Demarc & ITS/WAP Location inspection	1 day	Mon 7/18/16	Mon 7/18/16
116	Offender Calling locations - survey	1 day	Mon 7/18/16	Mon 7/18/16
117	Environmental evaluation & testing	1 day	Mon 7/18/16	Mon 7/18/16
118	MID STATE CORRECTIONAL FACILITY	1 day	Tue 7/19/16	Tue 7/19/16
119	Demarc & ITS/WAP Location inspection	1 day	Tue 7/19/16	Tue 7/19/16
120	Offender Calling locations - survey	1 day	Tue 7/19/16	Tue 7/19/16
121	Environmental evaluation & testing	1 day	Tue 7/19/16	Tue 7/19/16
122	MARCY CORRECTIONAL FACILITY	1 day	Wed 7/20/16	Wed 7/20/16
123	Demarc & ITS/WAP Location inspection	1 day	Wed 7/20/16	Wed 7/20/16
124	Offender Calling locations - survey	1 day	Wed 7/20/16	Wed 7/20/16
125	Environmental evaluation & testing	1 day	Wed 7/20/16	Wed 7/20/16
126	MOHAWK CORRECTIONAL FACILITY	1 day	Thu 7/21/16	Thu 7/21/16
127	Demarc & ITS/WAP Location inspection	1 day	Thu 7/21/16	Thu 7/21/16
128	Offender Calling locations - survey	1 day	Thu 7/21/16	Thu 7/21/16
129	Environmental evaluation & testing	1 day	Thu 7/21/16	Thu 7/21/16
130	BUTLER CORRECTIONAL FACILITY	1 day	Fri 7/22/16	Fri 7/22/16
131	Demarc & ITS/WAP Location inspection	1 day	Fri 7/22/16	Fri 7/22/16
132	Offender Calling locations - survey	1 day	Fri 7/22/16	Fri 7/22/16
133	Environmental evaluation & testing	1 day	Fri 7/22/16	Fri 7/22/16
134	AUBURN CORRECTIONAL FACILITY	1 day	Mon 7/25/16	Mon 7/25/16
135	Demarc & ITS/WAP Location inspection	1 day	Mon 7/25/16	Mon 7/25/16
136	Offender Calling locations - survey	1 day	Mon 7/25/16	Mon 7/25/16
137	Environmental evaluation & testing	1 day	Mon 7/25/16	Mon 7/25/16
138	CAYUGA CORRECTIONAL FACILITY	1 day	Tue 7/26/16	Tue 7/26/16
139	Demarc & ITS/WAP Location inspection	1 day	Tue 7/26/16	Tue 7/26/16
140	Offender Calling locations - survey	1 day	Tue 7/26/16	Tue 7/26/16
141	Environmental evaluation & testing	1 day	Tue 7/26/16	Tue 7/26/16
142	Region 3 - Facilities	16 days	Wed 7/6/16	Wed 7/27/16
143	LAKEVIEW SHOCK INCARCERATION CORRECTIONAL FACILITY	1 day	Wed 7/6/16	Wed 7/6/16
144	Demarc & ITS/WAP Location inspection	1 day	Wed 7/6/16	Wed 7/6/16
145	Offender Calling locations - survey	1 day	Wed 7/6/16	Wed 7/6/16
146	Environmental evaluation & testing	1 day	Wed 7/6/16	Wed 7/6/16
147	GOWANDA CORRECTIONAL FACILITY	1 day	Thu 7/7/16	Thu 7/7/16

ID	Task Name	Duration	Start	Finish
148	Demarc & ITS/WAP Location inspection	1 day	Thu 7/7/16	Thu 7/7/16
149	Offender Calling locations - survey	1 day	Thu 7/7/16	Thu 7/7/16
150	Environmental evaluation & testing	1 day	Thu 7/7/16	Thu 7/7/16
151	COLLINS CORRECTIONAL FACILITY	1 day	Fri 7/8/16	Fri 7/8/16
152	Demarc & ITS/WAP Location inspection	1 day	Fri 7/8/16	Fri 7/8/16
153	Offender Calling locations - survey	1 day	Fri 7/8/16	Fri 7/8/16
154	Environmental evaluation & testing	1 day	Fri 7/8/16	Fri 7/8/16
155	WENDE CORRECTIONAL FACILITY	1 day	Mon 7/11/16	Mon 7/11/16
156	Demarc & ITS/WAP Location inspection	1 day	Mon 7/11/16	Mon 7/11/16
157	Offender Calling locations - survey	1 day	Mon 7/11/16	Mon 7/11/16
158	Environmental evaluation & testing	1 day	Mon 7/11/16	Mon 7/11/16
159	ATTICA CORRECTIONAL FACILITY	1 day	Tue 7/12/16	Tue 7/12/16
160	Demarc & ITS/WAP Location inspection	1 day	Tue 7/12/16	Tue 7/12/16
161	Offender Calling locations - survey	1 day	Tue 7/12/16	Tue 7/12/16
162	Environmental evaluation & testing	1 day	Tue 7/12/16	Tue 7/12/16
163	WYOMING CORRECTIONAL FACILITY	1 day	Wed 7/13/16	Wed 7/13/16
164	Demarc & ITS/WAP Location inspection	1 day	Wed 7/13/16	Wed 7/13/16
165	Offender Calling locations - survey	1 day	Wed 7/13/16	Wed 7/13/16
166	Environmental evaluation & testing	1 day	Wed 7/13/16	Wed 7/13/16
167	ORLEANS CORRECTIONAL FACILITY	1 day	Thu 7/14/16	Thu 7/14/16
168	Demarc & ITS/WAP Location inspection	1 day	Thu 7/14/16	Thu 7/14/16
169	Offender Calling locations - survey	1 day	Thu 7/14/16	Thu 7/14/16
170	Environmental evaluation & testing	1 day	Thu 7/14/16	Thu 7/14/16
171	ALBION CORRECTIONAL FACILITY	1 day	Fri 7/15/16	Fri 7/15/16
172	Demarc & ITS/WAP Location inspection	1 day	Fri 7/15/16	Fri 7/15/16
173	Offender Calling locations - survey	1 day	Fri 7/15/16	Fri 7/15/16
174	Environmental evaluation & testing	1 day	Fri 7/15/16	Fri 7/15/16
175	ROCHESTER CORRECTIONAL FACILITY	1 day	Mon 7/18/16	Mon 7/18/16
176	Demarc & ITS/WAP Location inspection	1 day	Mon 7/18/16	Mon 7/18/16
177	Offender Calling locations - survey	1 day	Mon 7/18/16	Mon 7/18/16
178	Environmental evaluation & testing	1 day	Mon 7/18/16	Mon 7/18/16
179	LIVINGSTON CORRECTIONAL FACILITY	1 day	Tue 7/19/16	Tue 7/19/16
180	Demarc & ITS/WAP Location inspection	1 day	Tue 7/19/16	Tue 7/19/16
181	Offender Calling locations - survey	1 day	Tue 7/19/16	Tue 7/19/16
182	Environmental evaluation & testing	1 day	Tue 7/19/16	Tue 7/19/16
183	GROVELAND CORRECTIONAL FACILITY	1 day	Wed 7/20/16	Wed 7/20/16
184	Demarc & ITS/WAP Location inspection	1 day	Wed 7/20/16	Wed 7/20/16

ID	Task Name	Duration	Start	Finish
185	Offender Calling locations - survey	1 day	Wed 7/20/16	Wed 7/20/16
186	Environmental evaluation & testing	1 day	Wed 7/20/16	Wed 7/20/16
187	FIVE POINTS CORRECTIONAL FACILITY	1 day	Thu 7/21/16	Thu 7/21/16
188	Demarc & ITS/WAP Location inspection	1 day	Thu 7/21/16	Thu 7/21/16
189	Offender Calling locations - survey	1 day	Thu 7/21/16	Thu 7/21/16
190	Environmental evaluation & testing	1 day	Thu 7/21/16	Thu 7/21/16
191	WILLARD DRUG TREATMENT CAMPUS	1 day	Fri 7/22/16	Fri 7/22/16
192	Demarc & ITS/WAP Location inspection	1 day	Fri 7/22/16	Fri 7/22/16
193	Offender Calling locations - survey	1 day	Fri 7/22/16	Fri 7/22/16
194	Environmental evaluation & testing	1 day	Fri 7/22/16	Fri 7/22/16
195	MONTEREY SHOCK INCARCERATION CORRECTIONAL FACILITY	1 day	Mon 7/25/16	Mon 7/25/16
196	Demarc & ITS/WAP Location inspection	1 day	Mon 7/25/16	Mon 7/25/16
197	Offender Calling locations - survey	1 day	Mon 7/25/16	Mon 7/25/16
198	Environmental evaluation & testing	1 day	Mon 7/25/16	Mon 7/25/16
199	SOUTHPORT CORRECTIONAL FACILITY	1 day	Tue 7/26/16	Tue 7/26/16
200	Demarc & ITS/WAP Location inspection	1 day	Tue 7/26/16	Tue 7/26/16
201	Offender Calling locations - survey	1 day	Tue 7/26/16	Tue 7/26/16
202	Environmental evaluation & testing	1 day	Tue 7/26/16	Tue 7/26/16
203	ELMIRA CORRECTIONAL FACILITY AND RECEPTION CENTER	1 day	Wed 7/27/16	Wed 7/27/16
204	Demarc & ITS/WAP Location inspection	1 day	Wed 7/27/16	Wed 7/27/16
205	Offender Calling locations - survey	1 day	Wed 7/27/16	Wed 7/27/16
206	Environmental evaluation & testing	1 day	Wed 7/27/16	Wed 7/27/16
207	Region 4 - Facilities	14 days	Wed 7/6/16	Mon 7/25/16
208	SHAWANGUNK CORRECTIONAL FACILITY	1 day	Wed 7/6/16	Wed 7/6/16
209	Demarc & ITS/WAP Location inspection	1 day	Wed 7/6/16	Wed 7/6/16
210	Offender Calling locations - survey	1 day	Wed 7/6/16	Wed 7/6/16
211	Environmental evaluation & testing	1 day	Wed 7/6/16	Wed 7/6/16
212	WALLKILL CORRECTIONAL FACILITY	1 day	Thu 7/7/16	Thu 7/7/16
213	Demarc & ITS/WAP Location inspection	1 day	Thu 7/7/16	Thu 7/7/16
214	Offender Calling locations - survey	1 day	Thu 7/7/16	Thu 7/7/16
215	Environmental evaluation & testing	1 day	Thu 7/7/16	Thu 7/7/16
216	OTISVILLE CORRECTIONAL FACILITY	1 day	Fri 7/8/16	Fri 7/8/16
217	Demarc & ITS/WAP Location inspection	1 day	Fri 7/8/16	Fri 7/8/16
218	Offender Calling locations - survey	1 day	Fri 7/8/16	Fri 7/8/16
219	Environmental evaluation & testing	1 day	Fri 7/8/16	Fri 7/8/16
220	FISHKILL CORRECTIONAL FACILITY	1 day	Mon 7/11/16	Mon 7/11/16
221	Demarc & ITS/WAP Location inspection	1 day	Mon 7/11/16	Mon 7/11/16

ID	Task Name	Duration	Start	Finish
222	Offender Calling locations - survey	1 day	Mon 7/11/16	Mon 7/11/16
223	Environmental evaluation & testing	1 day	Mon 7/11/16	Mon 7/11/16
224	BEACON CORRECTIONAL FACILITY	1 day	Tue 7/12/16	Tue 7/12/16
225	Demarc & ITS/WAP Location inspection	1 day	Tue 7/12/16	Tue 7/12/16
226	Offender Calling locations - survey	1 day	Tue 7/12/16	Tue 7/12/16
227	Environmental evaluation & testing	1 day	Tue 7/12/16	Tue 7/12/16
228	DOWNSATE CORRECTIONAL FACILITY	1 day	Wed 7/13/16	Wed 7/13/16
229	Demarc & ITS/WAP Location inspection	1 day	Wed 7/13/16	Wed 7/13/16
230	Offender Calling locations - survey	1 day	Wed 7/13/16	Wed 7/13/16
231	Environmental evaluation & testing	1 day	Wed 7/13/16	Wed 7/13/16
232	GREEN HAVEN CORRECTIONAL FACILITY	1 day	Thu 7/14/16	Thu 7/14/16
233	Demarc & ITS/WAP Location inspection	1 day	Thu 7/14/16	Thu 7/14/16
234	Offender Calling locations - survey	1 day	Thu 7/14/16	Thu 7/14/16
235	Environmental evaluation & testing	1 day	Thu 7/14/16	Thu 7/14/16
236	TACONIC CORRECTIONAL FACILITY	1 day	Fri 7/15/16	Fri 7/15/16
237	Demarc & ITS/WAP Location inspection	1 day	Fri 7/15/16	Fri 7/15/16
238	Offender Calling locations - survey	1 day	Fri 7/15/16	Fri 7/15/16
239	Environmental evaluation & testing	1 day	Fri 7/15/16	Fri 7/15/16
240	BEDFORD HILLS CORRECTIONAL FACILITY	1 day	Mon 7/18/16	Mon 7/18/16
241	Demarc & ITS/WAP Location inspection	1 day	Mon 7/18/16	Mon 7/18/16
242	Offender Calling locations - survey	1 day	Mon 7/18/16	Mon 7/18/16
243	Environmental evaluation & testing	1 day	Mon 7/18/16	Mon 7/18/16
244	SING SING CORRECTIONAL FACILITY	1 day	Tue 7/19/16	Tue 7/19/16
245	Demarc & ITS/WAP Location inspection	1 day	Tue 7/19/16	Tue 7/19/16
246	Offender Calling locations - survey	1 day	Tue 7/19/16	Tue 7/19/16
247	Environmental evaluation & testing	1 day	Tue 7/19/16	Tue 7/19/16
248	EDGECOMBE RESIDENTIAL TREATMENT FACILITY	1 day	Wed 7/20/16	Wed 7/20/16
249	Demarc & ITS/WAP Location inspection	1 day	Wed 7/20/16	Wed 7/20/16
250	Offender Calling locations - survey	1 day	Wed 7/20/16	Wed 7/20/16
251	Environmental evaluation & testing	1 day	Wed 7/20/16	Wed 7/20/16
252	BAYVIEW CORRECTIONAL FACILITY	1 day	Thu 7/21/16	Thu 7/21/16
253	Demarc & ITS/WAP Location inspection	1 day	Thu 7/21/16	Thu 7/21/16
254	Offender Calling locations - survey	1 day	Thu 7/21/16	Thu 7/21/16
255	Environmental evaluation & testing	1 day	Thu 7/21/16	Thu 7/21/16
256	LINCOLN CORRECTIONAL FACILITY	1 day	Fri 7/22/16	Fri 7/22/16
257	Demarc & ITS/WAP Location inspection	1 day	Fri 7/22/16	Fri 7/22/16
258	Offender Calling locations - survey	1 day	Fri 7/22/16	Fri 7/22/16

ID	Task Name	Duration	Start	Finish
259	Environmental evaluation & testing	1 day	Fri 7/22/16	Fri 7/22/16
260	QUEENSBORO CORRECTIONAL FACILITY	1 day	Mon 7/25/16	Mon 7/25/16
261	Demarc & ITS/WAP Location inspection	1 day	Mon 7/25/16	Mon 7/25/16
262	Offender Calling locations - survey	1 day	Mon 7/25/16	Mon 7/25/16
263	Environmental evaluation & testing	1 day	Mon 7/25/16	Mon 7/25/16
264	Submit Initial Telecom & Equipment Orders (Preliminary Engineering & Design)	12 days	Fri 7/8/16	Mon 7/25/16
265	Submit orders to Telecom Vendors for MPLS/DSL/POTS/COCOT transport (based on RFP engine)	12 days	Fri 7/8/16	Mon 7/25/16
266	Submit orders for hardware to warehouse and vendors (vendor managed inventories)	12 days	Fri 7/8/16	Mon 7/25/16
267	Project Planning Phase	19.63 days	Tue 8/2/16	Mon 8/29/16
268	Project Plan Updates	0.25 days	Tue 8/2/16	Tue 8/2/16
269	Contact Telecom Vendor for estimated delivery dates on all transport orders	2 hrs	Tue 8/2/16	Tue 8/2/16
270	Obtain estimated delivery dates for ITS/WAP hardware materials	2 hrs	Tue 8/2/16	Tue 8/2/16
271	Securus & NY DOC Project Team Meeting - Touch Point	1.75 days	Tue 8/2/16	Wed 8/3/16
272	Review installation schedule and integration requirements	2 hrs	Tue 8/2/16	Tue 8/2/16
273	Review telecom and hardware delivery schedules	3 hrs	Tue 8/2/16	Tue 8/2/16
274	Update plan & scope of work based on any new information obtained during site surveys	3 hrs	Tue 8/2/16	Wed 8/3/16
275	Update Risk Management & Mitigation Plan	2 hrs	Wed 8/3/16	Wed 8/3/16
276	Internal Securus review to update project plan	2 hrs	Wed 8/3/16	Wed 8/3/16
277	Produce updated project plan and review with NY DOC Team	2 hrs	Wed 8/3/16	Wed 8/3/16
278	Engineering Schematics, Bill of Materials, and Manual of Procedure (MOP) Updates	0.63 days	Thu 8/4/16	Thu 8/4/16
279	Use site survey data to update	2 hrs	Thu 8/4/16	Thu 8/4/16
280	Produce & execute change orders if necessary	1 hr	Thu 8/4/16	Thu 8/4/16
281	Produce finalized engineering and MOP documentation	1 hr	Thu 8/4/16	Thu 8/4/16
282	Host Securus Project Team review meeting to review updated MOP and timelines	1 hr	Thu 8/4/16	Thu 8/4/16
283	Securus & NY DOC Project Team Meeting - Touch Point / Final Project Plan Sign-Off	0.38 days	Thu 8/4/16	Thu 8/4/16
284	Review updated project plan & MOP	1 hr	Thu 8/4/16	Thu 8/4/16
285	NY DOC Sign-Off on final plans	1 hr	Thu 8/4/16	Thu 8/4/16
286	Confirm building access & schedules for Securus Installation Teams	1 hr	Thu 8/4/16	Thu 8/4/16
287	Pre-install Preparation	16.63 days	Fri 8/5/16	Mon 8/29/16
288	Customer Provisioning	0.63 days	Fri 8/5/16	Fri 8/5/16
289	Provisioning requirements/features for each Site - ITS/WAP Customer Configuration	1 hr	Fri 8/5/16	Fri 8/5/16
290	Submit Customer Configurations to Install Support	1 hr	Fri 8/5/16	Fri 8/5/16
291	Equipment Provisioned to Site requirements/features	1 hr	Fri 8/5/16	Fri 8/5/16
292	Quality Control Checkpoint - Customer Provisioning	2 hrs	Fri 8/5/16	Fri 8/5/16
293	Customer Data Management	1 day	Fri 8/5/16	Mon 8/8/16
294	Retrieve customer specific data (block number lists, free calling lists, etc) from existing equipment	4 hrs	Fri 8/5/16	Mon 8/8/16
295	Site specific voice prompts & tag lines	1 hr	Mon 8/8/16	Mon 8/8/16

ID	Task Name	Duration	Start	Finish
296	Upload blocked number files	1 hr	Mon 8/8/16	Mon 8/8/16
297	Upload free and privileged number files	1 hr	Mon 8/8/16	Mon 8/8/16
298	Produce data migration plan for debit accounts and debit balances - coordinate transfers as each facility is migrated to Securus	1 hr	Mon 8/8/16	Mon 8/8/16
299	OMS/E-Imports Integration	15 days	Mon 8/8/16	Mon 8/29/16
300	Offender PIN account creation and management	1 wk	Mon 8/8/16	Mon 8/15/16
301	Offender PAN account creation and management	1 wk	Mon 8/15/16	Mon 8/22/16
302	Automated file delivery for account management and debit funds management	1 wk	Mon 8/22/16	Mon 8/29/16
303	Project Execution Phase	32.88 days	Tue 7/19/16	Fri 9/2/16
304	Local Exchange Carrier (LEC) access for MPLS/DSL/CABLE Installation	0.13 days	Tue 7/26/16	Tue 7/26/16
305	Confirm LEC access schedules with NY DOC contacts (LEC access only, Securus Technicians not required to be onsite)	1 hr	Tue 7/26/16	Tue 7/26/16
306	LEC transport Installations:	15.38 days	Thu 8/4/16	Thu 8/25/16
307	Region 1 - Facilities	14.38 days	Thu 8/4/16	Wed 8/24/16
308	CAPE VINCENT CORRECTIONAL FACILITY	3 hrs	Thu 8/4/16	Thu 8/4/16
309	WATERTOWN CORRECTIONAL FACILITY	3 hrs	Fri 8/5/16	Fri 8/5/16
310	GOUVERNEUR CORRECTIONAL FACILITY	3 hrs	Mon 8/8/16	Mon 8/8/16
311	RIVERVIEW CORRECTIONAL FACILITY	3 hrs	Tue 8/9/16	Tue 8/9/16
312	OGDENSBURG CORRECTIONAL FACILITY	3 hrs	Wed 8/10/16	Wed 8/10/16
313	FRANKLIN CORRECTIONAL FACILITY	3 hrs	Thu 8/11/16	Thu 8/11/16
314	BARE HILL CORRECTIONAL FACILITY	3 hrs	Fri 8/12/16	Fri 8/12/16
315	UPSTATE CORRECTIONAL FACILITY	3 hrs	Mon 8/15/16	Mon 8/15/16
316	CHATEAUGAY CORRECTIONAL FACILITY	3 hrs	Tue 8/16/16	Tue 8/16/16
317	ALTONA CORRECTIONAL FACILITY	3 hrs	Wed 8/17/16	Wed 8/17/16
318	CLINTON CORRECTIONAL FACILITY	3 hrs	Thu 8/18/16	Thu 8/18/16
319	ADIRONDACK CORRECTIONAL FACILITY	3 hrs	Fri 8/19/16	Fri 8/19/16
320	MORIAH SHOCK INCARCERATION CORRECTIONAL FACILITY	3 hrs	Mon 8/22/16	Mon 8/22/16
321	WASHINGTON CORRECTIONAL FACILITY	3 hrs	Tue 8/23/16	Tue 8/23/16
322	GREAT MEADOW CORRECTIONAL FACILITY	3 hrs	Wed 8/24/16	Wed 8/24/16
323	Region 2 - Facilities	6.75 days	Mon 8/15/16	Wed 8/24/16
324	WOODBOURNE CORRECTIONAL FACILITY	4 hrs	Mon 8/15/16	Tue 8/16/16
325	SULLIVAN CORRECTIONAL FACILITY	3 hrs	Mon 8/15/16	Mon 8/15/16
326	EASTERN NEW YORK CORRECTIONAL FACILITY	3 hrs	Mon 8/15/16	Mon 8/15/16
327	ULSTER CORRECTIONAL FACILITY	3 hrs	Mon 8/15/16	Mon 8/15/16
328	HUDSON CORRECTIONAL FACILITY	3 hrs	Wed 8/17/16	Wed 8/17/16
329	COXSACKIE CORRECTIONAL FACILITY	3 hrs	Wed 8/17/16	Wed 8/17/16
330	GREENE CORRECTIONAL FACILITY	3 hrs	Mon 8/15/16	Mon 8/15/16

ID	Task Name	Duration	Start	Finish
331	MT MCGREGOR CORRECTIONAL FACILITY	3 hrs	Mon 8/15/16	Mon 8/15/16
332	HALE CREEK CORRECTIONAL FACILITY	3 hrs	Mon 8/22/16	Mon 8/22/16
333	MID STATE CORRECTIONAL FACILITY	3 hrs	Mon 8/22/16	Mon 8/22/16
334	MARCY CORRECTIONAL FACILITY	3 hrs	Fri 8/19/16	Fri 8/19/16
335	MOHAWK CORRECTIONAL FACILITY	3 hrs	Mon 8/22/16	Mon 8/22/16
336	BUTLER CORRECTIONAL FACILITY	3 hrs	Mon 8/22/16	Mon 8/22/16
337	AUBURN CORRECTIONAL FACILITY	3 hrs	Tue 8/23/16	Tue 8/23/16
338	CAYUGA CORRECTIONAL FACILITY	3 hrs	Wed 8/24/16	Wed 8/24/16
339	Region 3 - Facilities	15.38 days	Thu 8/4/16	Thu 8/25/16
340	LAKEVIEW SHOCK INCARCERATION CORRECTIONAL FACILITY	3 hrs	Thu 8/4/16	Thu 8/4/16
341	GOWANDA CORRECTIONAL FACILITY	3 hrs	Fri 8/5/16	Fri 8/5/16
342	COLLINS CORRECTIONAL FACILITY	3 hrs	Mon 8/8/16	Mon 8/8/16
343	WENDE CORRECTIONAL FACILITY	3 hrs	Tue 8/9/16	Tue 8/9/16
344	ATTICA CORRECTIONAL FACILITY	3 hrs	Wed 8/10/16	Wed 8/10/16
345	WYOMING CORRECTIONAL FACILITY	3 hrs	Thu 8/11/16	Thu 8/11/16
346	ORLEANS CORRECTIONAL FACILITY	3 hrs	Fri 8/12/16	Fri 8/12/16
347	ALBION CORRECTIONAL FACILITY	3 hrs	Mon 8/15/16	Mon 8/15/16
348	ROCHESTER CORRECTIONAL FACILITY	3 hrs	Tue 8/16/16	Tue 8/16/16
349	LIVINGSTON CORRECTIONAL FACILITY	3 hrs	Wed 8/17/16	Wed 8/17/16
350	GROVELAND CORRECTIONAL FACILITY	3 hrs	Thu 8/18/16	Thu 8/18/16
351	FIVE POINTS CORRECTIONAL FACILITY	3 hrs	Fri 8/19/16	Fri 8/19/16
352	WILLARD DRUG TREATMENT CAMPUS	3 hrs	Mon 8/22/16	Mon 8/22/16
353	MONTREY SHOCK INCARCERATION CORRECTIONAL FACILITY	3 hrs	Tue 8/23/16	Tue 8/23/16
354	SOUTHPORT CORRECTIONAL FACILITY	3 hrs	Wed 8/24/16	Wed 8/24/16
355	ELMIRA CORRECTIONAL FACILITY AND RECEPTION CENTER	3 hrs	Thu 8/25/16	Thu 8/25/16
356	Region 4 - Facilities	8.38 days	Thu 8/11/16	Tue 8/23/16
357	SHAWANGUNK CORRECTIONAL FACILITY	3 hrs	Fri 8/12/16	Fri 8/12/16
358	WALLKILL CORRECTIONAL FACILITY	3 hrs	Tue 8/16/16	Tue 8/16/16
359	OTTISVILLE CORRECTIONAL FACILITY	3 hrs	Tue 8/16/16	Tue 8/16/16
360	FISHKILL CORRECTIONAL FACILITY	3 hrs	Mon 8/15/16	Mon 8/15/16
361	BEACON CORRECTIONAL FACILITY	3 hrs	Mon 8/15/16	Mon 8/15/16
362	DOWNSTATE CORRECTIONAL FACILITY	3 hrs	Thu 8/11/16	Thu 8/11/16
363	GREEN HAVEN CORRECTIONAL FACILITY	3 hrs	Fri 8/12/16	Fri 8/12/16
364	TACONIC CORRECTIONAL FACILITY	3 hrs	Mon 8/15/16	Mon 8/15/16
365	BEDFORD HILLS CORRECTIONAL FACILITY	3 hrs	Tue 8/16/16	Tue 8/16/16
366	SING SING CORRECTIONAL FACILITY	3 hrs	Wed 8/17/16	Wed 8/17/16
367	EDGECOMBE RESIDENTIAL TREATMENT FACILITY	3 hrs	Thu 8/18/16	Thu 8/18/16

ID	Task Name	Duration	Start	Finish
368	BAYVIEW CORRECTIONAL FACILITY	3 hrs	Fri 8/19/16	Fri 8/19/16
369	LINCOLN CORRECTIONAL FACILITY	3 hrs	Tue 8/23/16	Tue 8/23/16
370	QUEENSBORO CORRECTIONAL FACILITY	3 hrs	Tue 8/23/16	Tue 8/23/16
371	Securus & NY DOC Project Team Meeting - Touch Point	7.5 days	Wed 8/17/16	Fri 8/26/16
372	Review current progress	1 hr	Thu 8/25/16	Thu 8/25/16
373	Confirm LEC Installations progress	1 day	Thu 8/25/16	Fri 8/26/16
374	Confirm hardware Shipments processed and verified each facility delivery locations	1 day	Wed 8/17/16	Wed 8/17/16
375	Review and confirm Securus Installation Team schedules and facility access	1 day	Thu 8/18/16	Thu 8/18/16
376	Review and confirm Securus/Vendor plan	1 day	Fri 8/19/16	Fri 8/19/16
377	Review remaining actions for project plan - Including Incumbent exit strategy and MOP for out-over to Securus	1 day	Mon 8/22/16	Mon 8/22/16
378	OMS/E-Import Integration	11 days	Tue 7/19/16	Wed 8/3/16
379	Test integration for PIN account creation and management	2 wks	Tue 7/19/16	Tue 8/2/16
380	Test integration for PAN account creation and management	2 wks	Tue 7/19/16	Tue 8/2/16
381	Test integration for automated file delivery	2 wks	Tue 7/19/16	Tue 8/2/16
382	Test inmate debit within Secure Call Platform	2 days	Tue 7/19/16	Thu 7/21/16
383	Certify integration	1 day	Tue 8/2/16	Wed 8/3/16
384	Produce plan for integration / SCP installation - coordinate integration to complete when site is migrated to SCP	1 day	Tue 8/2/16	Wed 8/3/16
385	Facility Implementation of Hardware and Transport By Site	32.25 days	Tue 7/19/16	Fri 9/2/16
386	Installation Region 1 Facilities	26.88 days	Tue 7/19/16	Thu 8/25/16
387	CAPE VINCENT CORRECTIONAL FACILITY	5.38 days	Tue 7/19/16	Wed 7/27/16
388	Pre-Installation	4.38 days	Tue 7/19/16	Tue 7/26/16
389	Receipt & Pre-Install ITS/WAP Tasks	1.38 days	Tue 7/19/16	Thu 7/21/16
390	Receive Shipment at Site	1 hr	Tue 7/19/16	Tue 7/19/16
391	Verify shipment Content to Pick List	2 hrs	Wed 7/20/16	Wed 7/20/16
392	Telephone room preparation & wiring	1 day	Wed 7/20/16	Thu 7/21/16
393	Pre-Install Securus ITS/WAP equipment	1 day	Wed 7/20/16	Thu 7/21/16
394	Install ITS Phones & WAPs for Tablet Deployment	2 days	Thu 7/21/16	Mon 7/25/16
395	Phone room wiring and installation activity	1 day	Thu 7/21/16	Fri 7/22/16
396	Facility wiring and cross connections	1 day	Thu 7/21/16	Fri 7/22/16
397	Telephone replacements & installation of WAPs in dormitories	1 day	Fri 7/22/16	Mon 7/25/16
398	Quality Control Checkpoint: Customer Pre-Installation	1 day	Mon 7/25/16	Tue 7/26/16
399	Verify equipment inventory & installation location	1 day	Mon 7/25/16	Tue 7/26/16
400	Verify electrical, network/telecom, and telephone & WAP installations meet or exceed standards	1 day	Mon 7/25/16	Tue 7/26/16
401	Complete Field Technician Checklist & return to Project Manager	1 day	Mon 7/25/16	Tue 7/26/16

ID	Task Name	Duration	Start	Finish
402	Internal Quality Control Checkpoint: Equipment Testing / Functional Validation	1 day	Tue 7/26/16	Wed 7/27/16
403	Verify all Features working properly	1 day	Tue 7/26/16	Wed 7/27/16
404	Verify phones work, port assignments/call groups set	1 day	Tue 7/26/16	Wed 7/27/16
405	Complete Test & Validation Checklist and return to Project Manager	1 day	Tue 7/26/16	Wed 7/27/16
406	WATERTOWN CORRECTIONAL FACILITY	5.38 days	Tue 7/19/16	Wed 7/27/16
407	Pre-Installation	4.38 days	Tue 7/19/16	Tue 7/26/16
408	Receipt & Pre-Install ITS/WAP Tasks	1.38 days	Tue 7/19/16	Thu 7/21/16
409	Receive Shipment at Site	1 hr	Tue 7/19/16	Tue 7/19/16
410	Verify shipment Content to Pick List	2 hrs	Wed 7/20/16	Wed 7/20/16
411	Telephone room preparation & wiring	1 day	Wed 7/20/16	Thu 7/21/16
412	Pre-Install Securus ITS/WAP equipment	1 day	Wed 7/20/16	Thu 7/21/16
413	Install ITS/WAP Phones	2 days	Thu 7/21/16	Mon 7/25/16
414	Phone room wiring and installation activity	1 day	Thu 7/21/16	Fri 7/22/16
415	Facility wiring and cross connections	1 day	Thu 7/21/16	Fri 7/22/16
416	Telephone replacements/installation in dormitories	1 day	Fri 7/22/16	Mon 7/25/16
417	Quality Control Checkpoint: Customer Pre-Installation	1 day	Mon 7/25/16	Tue 7/26/16
418	Verify equipment inventory & installation location	1 day	Mon 7/25/16	Tue 7/26/16
419	Verify electrical, network/telecom, and telephone installations meet or exceed standa	1 day	Mon 7/25/16	Tue 7/26/16
420	Complete Field Technician Checklist & return to Project Manager	1 day	Mon 7/25/16	Tue 7/26/16
421	Internal Quality Control Checkpoint: Equipment Testing / Functional Validation	1 day	Tue 7/26/16	Wed 7/27/16
422	Verify all Features working properly	1 day	Tue 7/26/16	Wed 7/27/16
423	Verify phones work, port assignments/call groups set	1 day	Tue 7/26/16	Wed 7/27/16
424	Complete Test & Validation Checklist and return to Project Manager	1 day	Tue 7/26/16	Wed 7/27/16
425	GOUVERNEUR CORRECTIONAL FACILITY	5.38 days	Tue 7/19/16	Wed 7/27/16
426	Pre-Installation	4.38 days	Tue 7/19/16	Tue 7/26/16
427	Receipt & Pre-Install ITS/WAP Tasks	1.38 days	Tue 7/19/16	Thu 7/21/16
428	Receive Shipment at Site	1 hr	Tue 7/19/16	Tue 7/19/16
429	Verify shipment Content to Pick List	2 hrs	Wed 7/20/16	Wed 7/20/16
430	Telephone room preparation & wiring	1 day	Wed 7/20/16	Thu 7/21/16
431	Pre-Install Securus ITS/WAP equipment	1 day	Wed 7/20/16	Thu 7/21/16
432	Install ITS/WAP Phones	2 days	Thu 7/21/16	Mon 7/25/16
433	Phone room wiring and installation activity	1 day	Thu 7/21/16	Fri 7/22/16
434	Facility wiring and cross connections	1 day	Thu 7/21/16	Fri 7/22/16
435	Telephone replacements/installation in dormitories	1 day	Fri 7/22/16	Mon 7/25/16
436	Quality Control Checkpoint: Customer Pre-Installation	1 day	Mon 7/25/16	Tue 7/26/16
437	Verify equipment inventory & installation location	1 day	Mon 7/25/16	Tue 7/26/16
438	Verify electrical, network/telecom, and telephone installations meet or exceed standa	1 day	Mon 7/25/16	Tue 7/26/16

ID	Task Name	Duration	Start	Finish
439	Complete Field Technician Checklist & return to Project Manager	1 day	Mon 7/25/16	Tue 7/26/16
440	Internal Quality Control Checkpoint: Equipment Testing / Functional Validation	1 day	Tue 7/26/16	Wed 7/27/16
441	Verify all Features working properly	1 day	Tue 7/26/16	Wed 7/27/16
442	Verify phones work, port assignments/call groups set	1 day	Tue 7/26/16	Wed 7/27/16
443	Complete Test & Validation Checklist and return to Project Manager	1 day	Tue 7/26/16	Wed 7/27/16
444	RIVERVIEW CORRECTIONAL FACILITY	5.38 days	Wed 7/27/16	Wed 8/3/16
445	Pre-Installation	4.38 days	Wed 7/27/16	Tue 8/2/16
446	Receipt & Pre-Install ITS/WAP Tasks	1.38 days	Wed 7/27/16	Thu 7/28/16
447	Receive Shipment at Site	1 hr	Wed 7/27/16	Wed 7/27/16
448	Verify shipment Content to Pick List	2 hrs	Wed 7/27/16	Wed 7/27/16
449	Telephone room preparation & wiring	1 day	Wed 7/27/16	Thu 7/28/16
450	Pre-Install Securus ITS/WAP equipment	1 day	Wed 7/27/16	Thu 7/28/16
451	Install ITS/WAP Phones	2 days	Thu 7/28/16	Mon 8/1/16
452	Phone room wiring and installation activity	1 day	Thu 7/28/16	Fri 7/29/16
453	Facility wiring and cross connections	1 day	Thu 7/28/16	Fri 7/29/16
454	Telephone replacements/installation in dormitories	1 day	Fri 7/29/16	Mon 8/1/16
455	Quality Control Checkpoint: Customer Pre-Installation	1 day	Mon 8/1/16	Tue 8/2/16
456	Verify equipment inventory & installation location	1 day	Mon 8/1/16	Tue 8/2/16
457	Verify electrical network/telecom, and telephone installations meet or exceed standa	1 day	Mon 8/1/16	Tue 8/2/16
458	Complete Field Technician Checklist & return to Project Manager	1 day	Mon 8/1/16	Tue 8/2/16
459	Internal Quality Control Checkpoint: Equipment Testing / Functional Validation	1 day	Tue 8/2/16	Wed 8/3/16
460	Verify all Features working properly	1 day	Tue 8/2/16	Wed 8/3/16
461	Verify phones work, port assignments/call groups set	1 day	Tue 8/2/16	Wed 8/3/16
462	Complete Test & Validation Checklist and return to Project Manager	1 day	Tue 8/2/16	Wed 8/3/16
463	OGDENSBURG CORRECTIONAL FACILITY	5.38 days	Wed 7/27/16	Wed 8/3/16
464	Pre-Installation	4.38 days	Wed 7/27/16	Tue 8/2/16
465	Receipt & Pre-Install ITS/WAP Tasks	1.38 days	Wed 7/27/16	Thu 7/28/16
466	Receive Shipment at Site	1 hr	Wed 7/27/16	Wed 7/27/16
467	Verify shipment Content to Pick List	2 hrs	Wed 7/27/16	Wed 7/27/16
468	Telephone room preparation & wiring	1 day	Wed 7/27/16	Thu 7/28/16
469	Pre-Install Securus ITS/WAP equipment	1 day	Wed 7/27/16	Thu 7/28/16
470	Install ITS/WAP Phones	2 days	Thu 7/28/16	Mon 8/1/16
471	Phone room wiring and installation activity	1 day	Thu 7/28/16	Fri 7/29/16
472	Facility wiring and cross connections	1 day	Thu 7/28/16	Fri 7/29/16
473	Telephone replacements/installation in dormitories	1 day	Fri 7/29/16	Mon 8/1/16
474	Quality Control Checkpoint: Customer Pre-Installation	1 day	Mon 8/1/16	Tue 8/2/16
475	Verify equipment inventory & installation location	1 day	Mon 8/1/16	Tue 8/2/16

ID	Task Name	Duration	Start	Finish
476	Verify electrical, network/telecom, and telephone installations meet or exceed standa	1 day	Mon 8/1/16	Tue 8/2/16
477	Complete Field Technician Checklist & return to Project Manager	1 day	Mon 8/1/16	Tue 8/2/16
478	Internal Quality Control Checkpoint: Equipment Testing / Functional Validation	1 day	Tue 8/2/16	Wed 8/3/16
479	Verify all Features working properly	1 day	Tue 8/2/16	Wed 8/3/16
480	Verify phones work, port assignments/call groups set	1 day	Tue 8/2/16	Wed 8/3/16
481	Complete Test & Validation Checklist and return to Project Manager	1 day	Tue 8/2/16	Wed 8/3/16
482	FRANKLIN CORRECTIONAL FACILITY	5.38 days	Wed 7/27/16	Wed 8/3/16
483	Pre-Installation	4.38 days	Wed 7/27/16	Tue 8/2/16
484	Receipt & Pre-Install ITS/WAP Tasks	1.38 days	Wed 7/27/16	Thu 7/28/16
485	Receive Shipment at Site	1 hr	Wed 7/27/16	Wed 7/27/16
486	Verify shipment Content to Pick List	2 hrs	Wed 7/27/16	Wed 7/27/16
487	Telephone room preparation & wiring	1 day	Wed 7/27/16	Thu 7/28/16
488	Pre-Install Securus ITS/WAP equipment	1 day	Wed 7/27/16	Thu 7/28/16
489	Install ITS/WAP Phones	2 days	Thu 7/28/16	Mon 8/1/16
490	Phone room wiring and installation activity	1 day	Thu 7/28/16	Fri 7/29/16
491	Facility wiring and cross connections	1 day	Thu 7/28/16	Fri 7/29/16
492	Telephone replacements/installation in dormitories	1 day	Fri 7/29/16	Mon 8/1/16
493	Quality Control Checkpoint: Customer Pre-Installation	1 day	Mon 8/1/16	Tue 8/2/16
494	Verify equipment inventory & installation location	1 day	Mon 8/1/16	Tue 8/2/16
495	Verify electrical, network/telecom, and telephone installations meet or exceed standa	1 day	Mon 8/1/16	Tue 8/2/16
496	Complete Field Technician Checklist & return to Project Manager	1 day	Mon 8/1/16	Tue 8/2/16
497	Internal Quality Control Checkpoint: Equipment Testing / Functional Validation	1 day	Tue 8/2/16	Wed 8/3/16
498	Verify all Features working properly	1 day	Tue 8/2/16	Wed 8/3/16
499	Verify phones work, port assignments/call groups set	1 day	Tue 8/2/16	Wed 8/3/16
500	Complete Test & Validation Checklist and return to Project Manager	1 day	Tue 8/2/16	Wed 8/3/16
501	BARE HILL CORRECTIONAL FACILITY	5.38 days	Wed 8/3/16	Wed 8/10/16
502	Pre-Installation	4.38 days	Wed 8/3/16	Tue 8/9/16
503	Receipt & Pre-Install ITS/WAP Tasks	1.38 days	Wed 8/3/16	Thu 8/4/16
504	Receive Shipment at Site	1 hr	Wed 8/3/16	Wed 8/3/16
505	Verify shipment Content to Pick List	2 hrs	Wed 8/3/16	Wed 8/3/16
506	Telephone room preparation & wiring	1 day	Thu 8/4/16	Thu 8/4/16
507	Pre-Install Securus ITS/WAP equipment	1 day	Thu 8/4/16	Thu 8/4/16
508	Install ITS/WAP Phones	2 days	Fri 8/5/16	Mon 8/8/16
509	Phone room wiring and installation activity	1 day	Fri 8/5/16	Fri 8/5/16
510	Facility wiring and cross connections	1 day	Fri 8/5/16	Fri 8/5/16
511	Telephone replacements/installation in dormitories	1 day	Mon 8/8/16	Mon 8/8/16
512	Quality Control Checkpoint: Customer Pre-Installation	1 day	Tue 8/9/16	Tue 8/9/16

ID	Task Name	Duration	Start	Finish
513	Verify equipment inventory & installation location	1 day	Tue 8/9/16	Tue 8/9/16
514	Verify electrical, network/telecom, and telephone installations meet or exceed standa	1 day	Tue 8/9/16	Tue 8/9/16
515	Complete Field Technician Checklist & return to Project Manager	1 day	Tue 8/9/16	Tue 8/9/16
516	Internal Quality Control Checkpoint: Equipment Testing / Functional Validation	1 day	Wed 8/10/16	Wed 8/10/16
517	Verify all Features working properly	1 day	Wed 8/10/16	Wed 8/10/16
518	Verify phones work, port assignments/call groups set	1 day	Wed 8/10/16	Wed 8/10/16
519	Complete Test & Validation Checklist and return to Project Manager	1 day	Wed 8/10/16	Wed 8/10/16
520	UPSTATE CORRECTIONAL FACILITY	5.38 days	Wed 8/3/16	Wed 8/10/16
521	Pre-Installation	4.38 days	Wed 8/3/16	Tue 8/9/16
522	Receipt & Pre-Install ITS/WAP Tasks	1.38 days	Wed 8/3/16	Thu 8/4/16
523	Receive Shipment at Site	1 hr	Wed 8/3/16	Wed 8/3/16
524	Verify shipment Content to Pick List	2 hrs	Wed 8/3/16	Wed 8/3/16
525	Telephone room preparation & wiring	1 day	Thu 8/4/16	Thu 8/4/16
526	Pre-Install Securus ITS/WAP equipment	1 day	Thu 8/4/16	Thu 8/4/16
527	Install ITS/WAP Phones	2 days	Fri 8/5/16	Mon 8/8/16
528	Phone room wiring and installation activity	1 day	Fri 8/5/16	Fri 8/5/16
529	Facility wiring and cross connections	1 day	Fri 8/5/16	Fri 8/5/16
530	Telephone replacements/installation in dormitories	1 day	Mon 8/8/16	Mon 8/8/16
531	Quality Control Checkpoint: Customer Pre-Installation	1 day	Tue 8/9/16	Tue 8/9/16
532	Verify equipment inventory & installation location	1 day	Tue 8/9/16	Tue 8/9/16
533	Verify electrical, network/telecom, and telephone installations meet or exceed standa	1 day	Tue 8/9/16	Tue 8/9/16
534	Complete Field Technician Checklist & return to Project Manager	1 day	Tue 8/9/16	Tue 8/9/16
535	Internal Quality Control Checkpoint: Equipment Testing / Functional Validation	1 day	Wed 8/10/16	Wed 8/10/16
536	Verify all Features working properly	1 day	Wed 8/10/16	Wed 8/10/16
537	Verify phones work, port assignments/call groups set	1 day	Wed 8/10/16	Wed 8/10/16
538	Complete Test & Validation Checklist and return to Project Manager	1 day	Wed 8/10/16	Wed 8/10/16
539	CHATEAUGAY CORRECTIONAL FACILITY	5.38 days	Wed 8/3/16	Wed 8/10/16
540	Pre-Installation	4.38 days	Wed 8/3/16	Tue 8/9/16
541	Receipt & Pre-Install ITS/WAP Tasks	1.38 days	Wed 8/3/16	Thu 8/4/16
542	Receive Shipment at Site	1 hr	Wed 8/3/16	Wed 8/3/16
543	Verify shipment Content to Pick List	2 hrs	Wed 8/3/16	Wed 8/3/16
544	Telephone room preparation & wiring	1 day	Thu 8/4/16	Thu 8/4/16
545	Pre-Install Securus ITS/WAP equipment	1 day	Thu 8/4/16	Thu 8/4/16
546	Install ITS/WAP Phones	2 days	Fri 8/5/16	Mon 8/8/16
547	Phone room wiring and installation activity	1 day	Fri 8/5/16	Fri 8/5/16
548	Facility wiring and cross connections	1 day	Fri 8/5/16	Fri 8/5/16
549	Telephone replacements/installation in dormitories	1 day	Mon 8/8/16	Mon 8/8/16

ID	Task Name	Duration	Start	Finish
550	Quality Control Checkpoint: Customer Pre-Installation	1 day	Tue 8/9/16	Tue 8/9/16
551	Verify equipment inventory & installation location	1 day	Tue 8/9/16	Tue 8/9/16
552	Verify electrical, network/telecom, and telephone installations meet or exceed standards	1 day	Tue 8/9/16	Tue 8/9/16
553	Complete Field Technician Checklist & return to Project Manager	1 day	Tue 8/9/16	Tue 8/9/16
554	Internal Quality Control Checkpoint: Equipment Testing / Functional Validation	1 day	Wed 8/10/16	Wed 8/10/16
555	Verify all Features working properly	1 day	Wed 8/10/16	Wed 8/10/16
556	Verify phones work, port assignments/call groups set	1 day	Wed 8/10/16	Wed 8/10/16
557	Complete Test & Validation Checklist and return to Project Manager	1 day	Wed 8/10/16	Wed 8/10/16
558	ALTONA CORRECTIONAL FACILITY	5.38 days	Thu 8/11/16	Thu 8/18/16
559	Pre-Installation	4.38 days	Thu 8/11/16	Wed 8/17/16
560	Receipt & Pre-Install ITS/WAP Tasks	1.38 days	Thu 8/11/16	Fri 8/12/16
561	Receive Shipment at Site	1 hr	Thu 8/11/16	Thu 8/11/16
562	Verify shipment Content to Pick List	2 hrs	Thu 8/11/16	Thu 8/11/16
563	Telephone room preparation & wiring	1 day	Thu 8/11/16	Fri 8/12/16
564	Pre-Install Securus ITSWAP equipment	1 day	Thu 8/11/16	Fri 8/12/16
565	Install ITS/WAP Phones	2 days	Fri 8/12/16	Tue 8/16/16
566	Phone room wiring and installation activity	1 day	Fri 8/12/16	Mon 8/15/16
567	Facility wiring and cross connections	1 day	Fri 8/12/16	Mon 8/15/16
568	Telephone replacements/installation in dormitories	1 day	Mon 8/15/16	Tue 8/16/16
569	Quality Control Checkpoint: Customer Pre-Installation	1 day	Tue 8/16/16	Wed 8/17/16
570	Verify equipment inventory & installation location	1 day	Tue 8/16/16	Wed 8/17/16
571	Verify electrical, network/telecom, and telephone installations meet or exceed standards	1 day	Tue 8/16/16	Wed 8/17/16
572	Complete Field Technician Checklist & return to Project Manager	1 day	Tue 8/16/16	Wed 8/17/16
573	Internal Quality Control Checkpoint: Equipment Testing / Functional Validation	1 day	Wed 8/17/16	Thu 8/18/16
574	Verify all Features working properly	1 day	Wed 8/17/16	Thu 8/18/16
575	Verify phones work, port assignments/call groups set	1 day	Wed 8/17/16	Thu 8/18/16
576	Complete Test & Validation Checklist and return to Project Manager	1 day	Wed 8/17/16	Thu 8/18/16
577	CLINTON CORRECTIONAL FACILITY	5.38 days	Thu 8/11/16	Thu 8/18/16
578	Pre-Installation	4.38 days	Thu 8/11/16	Wed 8/17/16
579	Receipt & Pre-Install ITS/WAP Tasks	1.38 days	Thu 8/11/16	Fri 8/12/16
580	Receive Shipment at Site	1 hr	Thu 8/11/16	Thu 8/11/16
581	Verify shipment Content to Pick List	2 hrs	Thu 8/11/16	Thu 8/11/16
582	Telephone room preparation & wiring	1 day	Thu 8/11/16	Fri 8/12/16
583	Pre-Install Securus ITSWAP equipment	1 day	Thu 8/11/16	Fri 8/12/16
584	Install ITS/WAP Phones	2 days	Fri 8/12/16	Tue 8/16/16
585	Phone room wiring and installation activity	1 day	Fri 8/12/16	Mon 8/15/16
586	Facility wiring and cross connections	1 day	Fri 8/12/16	Mon 8/15/16

ID	Task Name	Duration	Start	Finish
587	Telephone replacements/installation in dormitories	1 day	Mon 8/15/16	Tue 8/16/16
588	Quality Control Checkpoint: Customer Pre-Installation	1 day	Tue 8/16/16	Wed 8/17/16
589	Verify equipment inventory & installation location	1 day	Tue 8/16/16	Wed 8/17/16
590	Verify electrical, network/telecom, and telephone installations meet or exceed standa	1 day	Tue 8/16/16	Wed 8/17/16
591	Complete Field Technician Checklist & return to Project Manager	1 day	Tue 8/16/16	Wed 8/17/16
592	Internal Quality Control Checkpoint: Equipment Testing / Functional Validation	1 day	Wed 8/17/16	Thu 8/18/16
593	Verify all Features working properly	1 day	Wed 8/17/16	Thu 8/18/16
594	Verify phones work, port assignments/call groups set	1 day	Wed 8/17/16	Thu 8/18/16
595	Complete Test & Validation Checklist and return to Project Manager	1 day	Wed 8/17/16	Thu 8/18/16
596	ADIRONDACK CORRECTIONAL FACILITY	5.38 days	Thu 8/11/16	Thu 8/18/16
597	Pre-Installation	4.38 days	Thu 8/11/16	Wed 8/17/16
598	Receipt & Pre-Install IT'SWAP Tasks	1.38 days	Thu 8/11/16	Fri 8/12/16
599	Receive Shipment at Site	1 hr	Thu 8/11/16	Thu 8/11/16
600	Verify shipment Content to Pick List	2 hrs	Thu 8/11/16	Thu 8/11/16
601	Telephone room preparation & wiring	1 day	Thu 8/11/16	Fri 8/12/16
602	Pre-Install Securus IT'SWAP equipment	1 day	Thu 8/11/16	Fri 8/12/16
603	Install IT'SWAP Phones	2 days	Fri 8/12/16	Tue 8/16/16
604	Phone room wiring and installation activity	1 day	Fri 8/12/16	Mon 8/15/16
605	Facility wiring and cross connections	1 day	Fri 8/12/16	Mon 8/15/16
606	Telephone replacements/installation in dormitories	1 day	Mon 8/15/16	Tue 8/16/16
607	Quality Control Checkpoint: Customer Pre-Installation	1 day	Tue 8/16/16	Wed 8/17/16
608	Verify equipment inventory & installation location	1 day	Tue 8/16/16	Wed 8/17/16
609	Verify electrical, network/telecom, and telephone installations meet or exceed standa	1 day	Tue 8/16/16	Wed 8/17/16
610	Complete Field Technician Checklist & return to Project Manager	1 day	Tue 8/16/16	Wed 8/17/16
611	Internal Quality Control Checkpoint: Equipment Testing / Functional Validation	1 day	Wed 8/17/16	Thu 8/18/16
612	Verify all Features working properly	1 day	Wed 8/17/16	Thu 8/18/16
613	Verify phones work, port assignments/call groups set	1 day	Wed 8/17/16	Thu 8/18/16
614	Complete Test & Validation Checklist and return to Project Manager	1 day	Wed 8/17/16	Thu 8/18/16
615	MORIAH SHOCK INCARCERATION CORRECTIONAL FACILITY	5.38 days	Thu 8/18/16	Thu 8/25/16
616	Pre-Installation	4.38 days	Thu 8/18/16	Wed 8/24/16
617	Receipt & Pre-Install IT'SWAP Tasks	1.38 days	Thu 8/18/16	Fri 8/19/16
618	Receive Shipment at Site	1 hr	Thu 8/18/16	Thu 8/18/16
619	Verify shipment Content to Pick List	2 hrs	Thu 8/18/16	Thu 8/18/16
620	Telephone room preparation & wiring	1 day	Thu 8/18/16	Fri 8/19/16
621	Pre-Install Securus IT'SWAP equipment	1 day	Thu 8/18/16	Fri 8/19/16
622	Install IT'SWAP Phones	2 days	Fri 8/19/16	Tue 8/23/16
623	Phone room wiring and installation activity	1 day	Fri 8/19/16	Mon 8/22/16

ID	Task Name	Duration	Start	Finish
624	Facility wiring and cross connections	1 day	Fri 8/19/16	Mon 8/22/16
625	Telephone replacements/installation in dormitories	1 day	Mon 8/22/16	Tue 8/23/16
626	Quality Control Checkpoint: Customer Pre-Installation	1 day	Tue 8/23/16	Wed 8/24/16
627	Verify equipment inventory & installation location	1 day	Tue 8/23/16	Wed 8/24/16
628	Verify electrical, network/telecom, and telephone installations meet or exceed standards	1 day	Tue 8/23/16	Wed 8/24/16
629	Complete Field Technician Checklist & return to Project Manager	1 day	Tue 8/23/16	Wed 8/24/16
630	Internal Quality Control Checkpoint: Equipment Testing / Functional Validation	1 day	Wed 8/24/16	Thu 8/25/16
631	Verify all Features working properly	1 day	Wed 8/24/16	Thu 8/25/16
632	Verify phones work, port assignments/call groups set	1 day	Wed 8/24/16	Thu 8/25/16
633	Complete Test & Validation Checklist and return to Project Manager	1 day	Wed 8/24/16	Thu 8/25/16
634	WASHINGTON CORRECTONAL FACILITY	5.38 days	Thu 8/18/16	Thu 8/25/16
635	Pre-Installation	4.38 days	Thu 8/18/16	Wed 8/24/16
636	Receipt & Pre-Install ITSWAP Tasks	1.38 days	Thu 8/18/16	Fri 8/19/16
637	Receive Shipment at Site	1 hr	Thu 8/18/16	Thu 8/18/16
638	Verify shipment Content to Pick List	2 hrs	Thu 8/18/16	Thu 8/18/16
639	Telephone room preparation & wiring	1 day	Thu 8/18/16	Fri 8/19/16
640	Pre-Install Securus ITSWAP equipment	1 day	Thu 8/18/16	Fri 8/19/16
641	Install ITSWAP Phones	2 days	Fri 8/19/16	Tue 8/23/16
642	Phone room wiring and installation activity	1 day	Fri 8/19/16	Mon 8/22/16
643	Facility wiring and cross connections	1 day	Fri 8/19/16	Mon 8/22/16
644	Telephone replacements/installation in dormitories	1 day	Mon 8/22/16	Tue 8/23/16
645	Quality Control Checkpoint: Customer Pre-Installation	1 day	Tue 8/23/16	Wed 8/24/16
646	Verify equipment inventory & installation location	1 day	Tue 8/23/16	Wed 8/24/16
647	Verify electrical, network/telecom, and telephone installations meet or exceed standards	1 day	Tue 8/23/16	Wed 8/24/16
648	Complete Field Technician Checklist & return to Project Manager	1 day	Tue 8/23/16	Wed 8/24/16
649	Internal Quality Control Checkpoint: Equipment Testing / Functional Validation	1 day	Wed 8/24/16	Thu 8/25/16
650	Verify all Features working properly	1 day	Wed 8/24/16	Thu 8/25/16
651	Verify phones work, port assignments/call groups set	1 day	Wed 8/24/16	Thu 8/25/16
652	Complete Test & Validation Checklist and return to Project Manager	1 day	Wed 8/24/16	Thu 8/25/16
653	GREAT MEADOW CORRECTONAL FACILITY	5.38 days	Thu 8/18/16	Thu 8/25/16
654	Pre-Installation	4.38 days	Thu 8/18/16	Wed 8/24/16
655	Receipt & Pre-Install ITSWAP Tasks	1.38 days	Thu 8/18/16	Fri 8/19/16
656	Receive Shipment at Site	1 hr	Thu 8/18/16	Thu 8/18/16
657	Verify shipment Content to Pick List	2 hrs	Thu 8/18/16	Thu 8/18/16
658	Telephone room preparation & wiring	1 day	Thu 8/18/16	Fri 8/19/16
659	Pre-Install Securus ITSWAP equipment	1 day	Thu 8/18/16	Fri 8/19/16
660	Install ITSWAP Phones	2 days	Fri 8/19/16	Tue 8/23/16

ID	Task Name	Duration	Start	Finish
661	Phone room wiring and installation activity	1 day	Fri 8/19/16	Mon 8/22/16
662	Facility wiring and cross connections	1 day	Fri 8/19/16	Mon 8/22/16
663	Telephone replacements/installation in dormitories	1 day	Mon 8/22/16	Tue 8/23/16
664	Quality Control Checkpoint: Customer Pre-Installation	1 day	Tue 8/23/16	Wed 8/24/16
665	Verify equipment inventory & installation location	1 day	Tue 8/23/16	Wed 8/24/16
666	Verify electrical, network/telecom, and telephone installations meet or exceed standards	1 day	Tue 8/23/16	Wed 8/24/16
667	Complete Field Technician Checklist & return to Project Manager	1 day	Tue 8/23/16	Wed 8/24/16
668	Internal Quality Control Checkpoint: Equipment Testing / Functional Validation	1 day	Wed 8/24/16	Thu 8/25/16
669	Verify all Features working properly	1 day	Wed 8/24/16	Thu 8/25/16
670	Verify phones work, port assignments/call groups set	1 day	Wed 8/24/16	Thu 8/25/16
671	Complete Test & Validation Checklist and return to Project Manager	1 day	Wed 8/24/16	Thu 8/25/16
672	Installation Region 2 Facilities	26.88 days	Tue 7/19/16	Thu 8/25/16
673	WOODBOURNE CORRECTIONAL FACILITY	5.38 days	Tue 7/19/16	Wed 7/27/16
674	Pre-Installation	4.38 days	Tue 7/19/16	Tue 7/26/16
675	Receipt & Pre-Install ITS/WAP Tasks	1.38 days	Tue 7/19/16	Thu 7/21/16
676	Receive Shipment at Site	1 hr	Tue 7/19/16	Tue 7/19/16
677	Verify shipment Content to Pick List	2 hrs	Wed 7/20/16	Wed 7/20/16
678	Telephone room preparation & wiring	1 day	Wed 7/20/16	Thu 7/21/16
679	Pre-Install Securus ITS/WAP equipment	1 day	Wed 7/20/16	Thu 7/21/16
680	Install ITS/WAP Phones	2 days	Thu 7/21/16	Mon 7/25/16
681	Phone room wiring and installation activity	1 day	Thu 7/21/16	Fri 7/22/16
682	Facility wiring and cross connections	1 day	Thu 7/21/16	Fri 7/22/16
683	Telephone replacements/installation in dormitories	1 day	Fri 7/22/16	Mon 7/25/16
684	Quality Control Checkpoint: Customer Pre-Installation	1 day	Mon 7/25/16	Tue 7/26/16
685	Verify equipment inventory & installation location	1 day	Mon 7/25/16	Tue 7/26/16
686	Verify electrical, network/telecom, and telephone installations meet or exceed standards	1 day	Mon 7/25/16	Tue 7/26/16
687	Complete Field Technician Checklist & return to Project Manager	1 day	Mon 7/25/16	Tue 7/26/16
688	Internal Quality Control Checkpoint: Equipment Testing / Functional Validation	1 day	Tue 7/26/16	Wed 7/27/16
689	Verify all Features working properly	1 day	Tue 7/26/16	Wed 7/27/16
690	Verify phones work, port assignments/call groups set	1 day	Tue 7/26/16	Wed 7/27/16
691	Complete Test & Validation Checklist and return to Project Manager	1 day	Tue 7/26/16	Wed 7/27/16
692	SULLIVAN CORRECTIONAL FACILITY	5.38 days	Tue 7/19/16	Wed 7/27/16
693	Pre-Installation	4.38 days	Tue 7/19/16	Tue 7/26/16
694	Receipt & Pre-Install ITS/WAP Tasks	1.38 days	Tue 7/19/16	Thu 7/21/16
695	Receive Shipment at Site	1 hr	Tue 7/19/16	Tue 7/19/16
696	Verify shipment Content to Pick List	2 hrs	Wed 7/20/16	Wed 7/20/16
697	Telephone room preparation & wiring	1 day	Wed 7/20/16	Thu 7/21/16

ID	Task Name	Duration	Start	Finish
698	Pre-Install Securus ITS/WAP equipment	1 day	Wed 7/20/16	Thu 7/21/16
699	Install ITS/WAP Phones	2 days	Thu 7/21/16	Mon 7/25/16
700	Phone room wiring and installation activity	1 day	Thu 7/21/16	Fri 7/22/16
701	Facility wiring and cross connections	1 day	Thu 7/21/16	Fri 7/22/16
702	Telephone replacements/installation in dormitories	1 day	Fri 7/22/16	Mon 7/25/16
703	Quality Control Checkpoint: Customer Pre-Installation	1 day	Mon 7/25/16	Tue 7/26/16
704	Verify equipment inventory & installation location	1 day	Mon 7/25/16	Tue 7/26/16
705	Verify electrical, network/telecom, and telephone installations meet or exceed standa	1 day	Mon 7/25/16	Tue 7/26/16
706	Complete Field Technician Checklist & return to Project Manager	1 day	Mon 7/25/16	Tue 7/26/16
707	Internal Quality Control Checkpoint: Equipment Testing / Functional Validation	1 day	Tue 7/26/16	Wed 7/27/16
708	Verify all Features working properly	1 day	Tue 7/26/16	Wed 7/27/16
709	Verify phones work, port assignments/call groups set	1 day	Tue 7/26/16	Wed 7/27/16
710	Complete Test & Validation Checklist and return to Project Manager	1 day	Tue 7/26/16	Wed 7/27/16
711	EASTERN NEW YORK CORRECTIONAL FACILITY	5.38 days	Tue 7/19/16	Wed 7/27/16
712	Pre-Installation	4.38 days	Tue 7/19/16	Tue 7/26/16
713	Receipt & Pre-Install ITS/WAP Tasks	1.38 days	Tue 7/19/16	Thu 7/21/16
714	Receive Shipment at Site	1 hr	Tue 7/19/16	Tue 7/19/16
715	Verify shipment Content to Pick List	2 hrs	Wed 7/20/16	Wed 7/20/16
716	Telephone room preparation & wiring	1 day	Wed 7/20/16	Thu 7/21/16
717	Pre-Install Securus ITS/WAP equipment	1 day	Wed 7/20/16	Thu 7/21/16
718	Install ITS/WAP Phones	2 days	Thu 7/21/16	Mon 7/25/16
719	Phone room wiring and installation activity	1 day	Thu 7/21/16	Fri 7/22/16
720	Facility wiring and cross connections	1 day	Thu 7/21/16	Fri 7/22/16
721	Telephone replacements/installation in dormitories	1 day	Fri 7/22/16	Mon 7/25/16
722	Quality Control Checkpoint: Customer Pre-Installation	1 day	Mon 7/25/16	Tue 7/26/16
723	Verify equipment inventory & installation location	1 day	Mon 7/25/16	Tue 7/26/16
724	Verify electrical, network/telecom, and telephone installations meet or exceed standa	1 day	Mon 7/25/16	Tue 7/26/16
725	Complete Field Technician Checklist & return to Project Manager	1 day	Mon 7/25/16	Tue 7/26/16
726	Internal Quality Control Checkpoint: Equipment Testing / Functional Validation	1 day	Tue 7/26/16	Wed 7/27/16
727	Verify all Features working properly	1 day	Tue 7/26/16	Wed 7/27/16
728	Verify phones work, port assignments/call groups set	1 day	Tue 7/26/16	Wed 7/27/16
729	Complete Test & Validation Checklist and return to Project Manager	1 day	Tue 7/26/16	Wed 7/27/16
730	ULSTER CORRECTIONAL FACILITY	5.38 days	Wed 7/27/16	Wed 7/27/16
731	Pre-Installation	4.38 days	Wed 7/27/16	Tue 8/2/16
732	Receipt & Pre-Install ITS/WAP Tasks	1.38 days	Wed 7/27/16	Thu 7/28/16
733	Receive Shipment at Site	1 hr	Wed 7/27/16	Wed 7/27/16
734	Verify shipment Content to Pick List	2 hrs	Wed 7/27/16	Wed 7/27/16

ID	Task Name	Duration	Start	Finish
735	Telephone room preparation & wiring	1 day	Wed 7/27/16	Thu 7/28/16
736	Pre-Install Securus ITSWAP equipment	1 day	Wed 7/27/16	Thu 7/28/16
737	Install ITSWAP Phones	2 days	Thu 7/28/16	Mon 8/1/16
738	Phone room wiring and installation activity	1 day	Thu 7/28/16	Fri 7/29/16
739	Facility wiring and cross connections	1 day	Thu 7/28/16	Fri 7/29/16
740	Telephone replacements/installation in dormitories	1 day	Fri 7/29/16	Mon 8/1/16
741	Quality Control Checkpoint: Customer Pre-Installation	1 day	Mon 8/1/16	Tue 8/2/16
742	Verify equipment inventory & installation location	1 day	Mon 8/1/16	Tue 8/2/16
743	Verify electrical, network/telecom, and telephone installations meet or exceed standa	1 day	Mon 8/1/16	Tue 8/2/16
744	Complete Field Technician Checklist & return to Project Manager	1 day	Mon 8/1/16	Tue 8/2/16
745	Internal Quality Control Checkpoint: Equipment Testing / Functional Validation	1 day	Tue 8/2/16	Wed 8/3/16
746	Verify all Features working properly	1 day	Tue 8/2/16	Wed 8/3/16
747	Verify phones work, port assignments/call groups set	1 day	Tue 8/2/16	Wed 8/3/16
748	Complete Test & Validation Checklist and return to Project Manager	1 day	Tue 8/2/16	Wed 8/3/16
749	HUDSON CORRECTIONAL FACILITY	5.38 days	Wed 7/27/16	Wed 8/3/16
750	Pre-Installation	4.38 days	Wed 7/27/16	Tue 8/2/16
751	Receipt & Pre-Install ITSWAP Tasks	1.38 days	Wed 7/27/16	Thu 7/28/16
752	Receive Shipment at Site	1 hr	Wed 7/27/16	Wed 7/27/16
753	Verify shipment Content to Pick List	2 hrs	Wed 7/27/16	Wed 7/27/16
754	Telephone room preparation & wiring	1 day	Wed 7/27/16	Thu 7/28/16
755	Pre-Install Securus ITSWAP equipment	1 day	Wed 7/27/16	Thu 7/28/16
756	Install ITSWAP Phones	2 days	Thu 7/28/16	Mon 8/1/16
757	Phone room wiring and installation activity	1 day	Thu 7/28/16	Fri 7/29/16
758	Facility wiring and cross connections	1 day	Thu 7/28/16	Fri 7/29/16
759	Telephone replacements/installation in dormitories	1 day	Fri 7/29/16	Mon 8/1/16
760	Quality Control Checkpoint: Customer Pre-Installation	1 day	Mon 8/1/16	Tue 8/2/16
761	Verify equipment inventory & installation location	1 day	Mon 8/1/16	Tue 8/2/16
762	Verify electrical, network/telecom, and telephone installations meet or exceed standa	1 day	Mon 8/1/16	Tue 8/2/16
763	Complete Field Technician Checklist & return to Project Manager	1 day	Mon 8/1/16	Tue 8/2/16
764	Internal Quality Control Checkpoint: Equipment Testing / Functional Validation	1 day	Tue 8/2/16	Wed 8/3/16
765	Verify all Features working properly	1 day	Tue 8/2/16	Wed 8/3/16
766	Verify phones work, port assignments/call groups set	1 day	Tue 8/2/16	Wed 8/3/16
767	Complete Test & Validation Checklist and return to Project Manager	1 day	Tue 8/2/16	Wed 8/3/16
768	COXSACKIE CORRECTIONAL FACILITY	5.38 days	Wed 7/27/16	Wed 8/3/16
769	Pre-Installation	4.38 days	Wed 7/27/16	Tue 8/2/16
770	Receipt & Pre-Install ITSWAP Tasks	1.38 days	Wed 7/27/16	Thu 7/28/16
771	Receive Shipment at Site	1 hr	Wed 7/27/16	Wed 7/27/16

ID	Task Name	Duration	Start	Finish
772	Verify shipment Content to Pick List	2 hrs	Wed 7/27/16	Wed 7/27/16
773	Telephone room preparation & wiring	1 day	Wed 7/27/16	Thu 7/28/16
774	Pre-Install Securus ITSWAP equipment	1 day	Wed 7/27/16	Thu 7/28/16
775	Install ITSWAP Phones	2 days	Thu 7/28/16	Mon 8/1/16
776	Phone room wiring and installation activity	1 day	Thu 7/28/16	Fri 7/29/16
777	Facility wiring and cross connections	1 day	Thu 7/28/16	Fri 7/29/16
778	Telephone replacements/installation in dormitories	1 day	Fri 7/29/16	Mon 8/1/16
779	Quality Control Checkpoint: Customer Pre-Installation	1 day	Mon 8/1/16	Tue 8/2/16
780	Verify equipment inventory & installation location	1 day	Mon 8/1/16	Tue 8/2/16
781	Verify electrical, network/telecom, and telephone installations meet or exceed standa	1 day	Mon 8/1/16	Tue 8/2/16
782	Complete Field Technician Checklist & return to Project Manager	1 day	Mon 8/1/16	Tue 8/2/16
783	Internal Quality Control Checkpoint: Equipment Testing / Functional Validation	1 day	Tue 8/2/16	Wed 8/3/16
784	Verify all Features working properly	1 day	Tue 8/2/16	Wed 8/3/16
785	Verify phones work, port assignments/call groups set	1 day	Tue 8/2/16	Wed 8/3/16
786	Complete Test & Validation Checklist and return to Project Manager	1 day	Tue 8/2/16	Wed 8/3/16
787	GREENE CORRECTIONAL FACILITY	5.38 days	Wed 8/3/16	Wed 8/10/16
788	Pre-Installation	4.38 days	Wed 8/3/16	Tue 8/9/16
789	Receipt & Pre-Install ITSWAP Tasks	1.38 days	Wed 8/3/16	Thu 8/4/16
790	Receive Shipment at Site	1 hr	Wed 8/3/16	Wed 8/3/16
791	Verify shipment Content to Pick List	2 hrs	Wed 8/3/16	Wed 8/3/16
792	Telephone room preparation & wiring	1 day	Thu 8/4/16	Thu 8/4/16
793	Pre-Install Securus ITSWAP equipment	1 day	Thu 8/4/16	Thu 8/4/16
794	Install ITSWAP Phones	2 days	Fri 8/5/16	Mon 8/8/16
795	Phone room wiring and installation activity	1 day	Fri 8/5/16	Fri 8/5/16
796	Facility wiring and cross connections	1 day	Fri 8/5/16	Fri 8/5/16
797	Telephone replacements/installation in dormitories	1 day	Mon 8/8/16	Mon 8/8/16
798	Quality Control Checkpoint: Customer Pre-Installation	1 day	Tue 8/9/16	Tue 8/9/16
799	Verify equipment inventory & installation location	1 day	Tue 8/9/16	Tue 8/9/16
800	Verify electrical, network/telecom, and telephone installations meet or exceed standa	1 day	Tue 8/9/16	Tue 8/9/16
801	Complete Field Technician Checklist & return to Project Manager	1 day	Tue 8/9/16	Tue 8/9/16
802	Internal Quality Control Checkpoint: Equipment Testing / Functional Validation	1 day	Wed 8/10/16	Wed 8/10/16
803	Verify all Features working properly	1 day	Wed 8/10/16	Wed 8/10/16
804	Verify phones work, port assignments/call groups set	1 day	Wed 8/10/16	Wed 8/10/16
805	Complete Test & Validation Checklist and return to Project Manager	1 day	Wed 8/10/16	Wed 8/10/16
806	MT MCGREGOR CORRECTIONAL FACILITY	5.38 days	Wed 8/3/16	Wed 8/10/16
807	Pre-Installation	4.38 days	Wed 8/3/16	Tue 8/9/16
808	Receipt & Pre-Install ITSWAP Tasks	1.38 days	Wed 8/3/16	Thu 8/4/16

ID	Task Name	Duration	Start	Finish
809	Receive Shipment at Site	1 hr	Wed 8/3/16	Wed 8/3/16
810	Verify shipment Content to Pick List	2 hrs	Wed 8/3/16	Wed 8/3/16
811	Telephone room preparation & wiring	1 day	Thu 8/4/16	Thu 8/4/16
812	Pre-Install Securus ITSWAP equipment	1 day	Thu 8/4/16	Thu 8/4/16
813	Install ITSWAP Phones	2 days	Fri 8/5/16	Mon 8/8/16
814	Phone room wiring and installation activity	1 day	Fri 8/5/16	Fri 8/5/16
815	Facility wiring and cross connections	1 day	Fri 8/5/16	Fri 8/5/16
816	Telephone replacements/installation in dormitories	1 day	Mon 8/8/16	Mon 8/8/16
817	Quality Control Checkpoint: Customer Pre-Installation	1 day	Tue 8/9/16	Tue 8/9/16
818	Verify equipment inventory & installation location	1 day	Tue 8/9/16	Tue 8/9/16
819	Verify electrical, network/telecom, and telephone installations meet or exceed standards	1 day	Tue 8/9/16	Tue 8/9/16
820	Complete Field Technician Checklist & return to Project Manager	1 day	Tue 8/9/16	Tue 8/9/16
821	Internal Quality Control Checkpoint: Equipment Testing / Functional Validation	1 day	Wed 8/10/16	Wed 8/10/16
822	Verify all Features working properly	1 day	Wed 8/10/16	Wed 8/10/16
823	Verify phones work, port assignments/call groups set	1 day	Wed 8/10/16	Wed 8/10/16
824	Complete Test & Validation Checklist and return to Project Manager	1 day	Wed 8/10/16	Wed 8/10/16
825	HALE CREEK CORRECTIONAL FACILITY	5.38 days	Wed 8/3/16	Wed 8/10/16
826	Pre-Installation	4.38 days	Wed 8/3/16	Tue 8/9/16
827	Receipt & Pre-Install ITSWAP Tasks	1.38 days	Wed 8/3/16	Thu 8/4/16
828	Receive Shipment at Site	1 hr	Wed 8/3/16	Wed 8/3/16
829	Verify shipment Content to Pick List	2 hrs	Wed 8/3/16	Wed 8/3/16
830	Telephone room preparation & wiring	1 day	Thu 8/4/16	Thu 8/4/16
831	Pre-Install Securus ITSWAP equipment	1 day	Thu 8/4/16	Thu 8/4/16
832	Install ITSWAP Phones	2 days	Fri 8/5/16	Mon 8/8/16
833	Phone room wiring and installation activity	1 day	Fri 8/5/16	Fri 8/5/16
834	Facility wiring and cross connections	1 day	Fri 8/5/16	Fri 8/5/16
835	Telephone replacements/installation in dormitories	1 day	Mon 8/8/16	Mon 8/8/16
836	Quality Control Checkpoint: Customer Pre-Installation	1 day	Tue 8/9/16	Tue 8/9/16
837	Verify equipment inventory & installation location	1 day	Tue 8/9/16	Tue 8/9/16
838	Verify electrical, network/telecom, and telephone installations meet or exceed standards	1 day	Tue 8/9/16	Tue 8/9/16
839	Complete Field Technician Checklist & return to Project Manager	1 day	Tue 8/9/16	Tue 8/9/16
840	Internal Quality Control Checkpoint: Equipment Testing / Functional Validation	1 day	Wed 8/10/16	Wed 8/10/16
841	Verify all Features working properly	1 day	Wed 8/10/16	Wed 8/10/16
842	Verify phones work, port assignments/call groups set	1 day	Wed 8/10/16	Wed 8/10/16
843	Complete Test & Validation Checklist and return to Project Manager	1 day	Wed 8/10/16	Wed 8/10/16
844	MID STATE CORRECTIONAL FACILITY	5.38 days	Thu 8/11/16	Thu 8/18/16
845	Pre-Installation	4.38 days	Thu 8/11/16	Wed 8/17/16

ID	Task Name	Duration	Start	Finish
846	Receipt & Pre-Install ITS/WAP Tasks	1.38 days	Thu 8/11/16	Fri 8/12/16
847	Receive Shipment at Site	1 hr	Thu 8/11/16	Thu 8/11/16
848	Verify shipment Content to Pick List	2 hrs	Thu 8/11/16	Thu 8/11/16
849	Telephone room preparation & wiring	1 day	Thu 8/11/16	Fri 8/12/16
850	Pre-Install Securus ITS/WAP equipment	1 day	Thu 8/11/16	Fri 8/12/16
851	Install ITS/WAP Phones	2 days	Fri 8/12/16	Tue 8/16/16
852	Phone room wiring and installation activity	1 day	Fri 8/12/16	Mon 8/15/16
853	Facility wiring and cross connections	1 day	Fri 8/12/16	Mon 8/15/16
854	Telephone replacements/installation in dormitories	1 day	Mon 8/15/16	Tue 8/16/16
855	Quality Control Checkpoint: Customer Pre-Installation	1 day	Tue 8/16/16	Wed 8/17/16
856	Verify equipment inventory & installation location	1 day	Tue 8/16/16	Wed 8/17/16
857	Verify electrical, network/telecom, and telephone installations meet or exceed standa	1 day	Tue 8/16/16	Wed 8/17/16
858	Complete Field Technician Checklist & return to Project Manager	1 day	Tue 8/16/16	Wed 8/17/16
859	Internal Quality Control Checkpoint: Equipment Testing / Functional Validation	1 day	Wed 8/17/16	Thu 8/18/16
860	Verify all Features working properly	1 day	Wed 8/17/16	Thu 8/18/16
861	Verify phones work, port assignments/call groups set	1 day	Wed 8/17/16	Thu 8/18/16
862	Complete Test & Validation Checklist and return to Project Manager	1 day	Wed 8/17/16	Thu 8/18/16
863	MARCY CORRECTIONAL FACILITY			
864	Pre-Installation			
865	Receipt & Pre-Install ITS/WAP Tasks	4.38 days	Thu 8/11/16	Wed 8/17/16
866	Receive Shipment at Site	1.38 days	Thu 8/11/16	Fri 8/12/16
867	Verify shipment Content to Pick List	1 hr	Thu 8/11/16	Thu 8/11/16
868	Telephone room preparation & wiring	2 hrs	Thu 8/11/16	Thu 8/11/16
869	Pre-Install Securus ITS/WAP equipment	1 day	Thu 8/11/16	Fri 8/12/16
870	Install ITS/WAP Phones	2 days	Fri 8/12/16	Tue 8/16/16
871	Phone room wiring and installation activity	1 day	Fri 8/12/16	Mon 8/15/16
872	Facility wiring and cross connections	1 day	Fri 8/12/16	Mon 8/15/16
873	Telephone replacements/installation in dormitories	1 day	Mon 8/15/16	Tue 8/16/16
874	Quality Control Checkpoint: Customer Pre-Installation	1 day	Tue 8/16/16	Wed 8/17/16
875	Verify equipment inventory & installation location	1 day	Tue 8/16/16	Wed 8/17/16
876	Verify electrical, network/telecom, and telephone installations meet or exceed standa	1 day	Tue 8/16/16	Wed 8/17/16
877	Complete Field Technician Checklist & return to Project Manager	1 day	Tue 8/16/16	Wed 8/17/16
878	Internal Quality Control Checkpoint: Equipment Testing / Functional Validation	1 day	Wed 8/17/16	Thu 8/18/16
879	Verify all Features working properly	1 day	Wed 8/17/16	Thu 8/18/16
880	Verify phones work, port assignments/call groups set	1 day	Wed 8/17/16	Thu 8/18/16
881	Complete Test & Validation Checklist and return to Project Manager	1 day	Wed 8/17/16	Thu 8/18/16
882	MOHAWK CORRECTIONAL FACILITY			
		5.38 days	Thu 8/11/16	Thu 8/18/16

ID	Task Name	Duration	Start	Finish
883	Pre-Installation	4.38 days	Thu 8/11/16	Wed 8/17/16
884	Receipt & Pre-Install ITS/WAP Tasks	1.38 days	Thu 8/11/16	Fri 8/12/16
885	Receive Shipment at Site	1 hr	Thu 8/11/16	Thu 8/11/16
886	Verify shipment Content to Pick List	2 hrs	Thu 8/11/16	Thu 8/11/16
887	Telephone room preparation & wiring	1 day	Thu 8/11/16	Fri 8/12/16
888	Pre-Install Securus ITS/WAP equipment	1 day	Thu 8/11/16	Fri 8/12/16
889	Install ITS/WAP Phones	2 days	Fri 8/12/16	Tue 8/16/16
890	Phone room wiring and installation activity	1 day	Fri 8/12/16	Mon 8/15/16
891	Facility wiring and cross connections	1 day	Fri 8/12/16	Mon 8/15/16
892	Telephone replacements/installation in dormitories	1 day	Mon 8/15/16	Tue 8/16/16
893	Quality Control Checkpoint: Customer Pre-Installation	1 day	Tue 8/16/16	Wed 8/17/16
894	Verify equipment inventory & installation location	1 day	Tue 8/16/16	Wed 8/17/16
895	Verify electrical, network/telecom, and telephone installations meet or exceed standa	1 day	Tue 8/16/16	Wed 8/17/16
896	Complete Field Technician Checklist & return to Project Manager	1 day	Tue 8/16/16	Wed 8/17/16
897	Internal Quality Control Checkpoint: Equipment Testing / Functional Validation	1 day	Wed 8/17/16	Thu 8/18/16
898	Verify all Features working properly	1 day	Wed 8/17/16	Thu 8/18/16
899	Verify phones work, port assignments/call groups set	1 day	Wed 8/17/16	Thu 8/18/16
900	Complete Test & Validation Checklist and return to Project Manager	1 day	Wed 8/17/16	Thu 8/18/16
901	BUTLER CORRECTIONAL FACILITY	5.38 days	Thu 8/18/16	Thu 8/25/16
902	Pre-Installation	4.38 days	Thu 8/18/16	Wed 8/24/16
903	Receipt & Pre-Install ITS/WAP Tasks	1.38 days	Thu 8/18/16	Fri 8/19/16
904	Receive Shipment at Site	1 hr	Thu 8/18/16	Thu 8/18/16
905	Verify shipment Content to Pick List	2 hrs	Thu 8/18/16	Thu 8/18/16
906	Telephone room preparation & wiring	1 day	Thu 8/18/16	Fri 8/19/16
907	Pre-Install Securus ITS/WAP equipment	1 day	Thu 8/18/16	Fri 8/19/16
908	Install ITS/WAP Phones	2 days	Fri 8/19/16	Tue 8/23/16
909	Phone room wiring and installation activity	1 day	Fri 8/19/16	Mon 8/22/16
910	Facility wiring and cross connections	1 day	Fri 8/19/16	Mon 8/22/16
911	Telephone replacements/installation in dormitories	1 day	Mon 8/22/16	Tue 8/23/16
912	Quality Control Checkpoint: Customer Pre-Installation	1 day	Tue 8/23/16	Wed 8/24/16
913	Verify equipment inventory & installation location	1 day	Tue 8/23/16	Wed 8/24/16
914	Verify electrical, network/telecom, and telephone installations meet or exceed standa	1 day	Tue 8/23/16	Wed 8/24/16
915	Complete Field Technician Checklist & return to Project Manager	1 day	Tue 8/23/16	Wed 8/24/16
916	Internal Quality Control Checkpoint: Equipment Testing / Functional Validation	1 day	Wed 8/24/16	Thu 8/25/16
917	Verify all Features working properly	1 day	Wed 8/24/16	Thu 8/25/16
918	Verify phones work, port assignments/call groups set	1 day	Wed 8/24/16	Thu 8/25/16
919	Complete Test & Validation Checklist and return to Project Manager	1 day	Wed 8/24/16	Thu 8/25/16

ID	Task Name	Duration	Start	Finish
920	AUBURN CORRECTIONAL FACILITY	5.38 days	Thu 8/18/16	Thu 8/25/16
921	Pre-Installation	4.38 days	Thu 8/18/16	Wed 8/24/16
922	Receipt & Pre-Install ITS/WAP Tasks	1.38 days	Thu 8/18/16	Fri 8/19/16
923	Receive Shipment at Site	1 hr	Thu 8/18/16	Thu 8/18/16
924	Verify shipment Content to Pick List	2 hrs	Thu 8/18/16	Thu 8/18/16
925	Telephone room preparation & wiring	1 day	Thu 8/18/16	Fri 8/19/16
926	Pre-Install Securus ITS/WAP equipment	1 day	Thu 8/18/16	Fri 8/19/16
927	Install ITS/WAP Phones	2 days	Fri 8/19/16	Tue 8/23/16
928	Phone room wiring and installation activity	1 day	Fri 8/19/16	Mon 8/22/16
929	Facility wiring and cross connections	1 day	Fri 8/19/16	Mon 8/22/16
930	Telephone replacements/installation in dormitories	1 day	Mon 8/22/16	Tue 8/23/16
931	Quality Control Checkpoint: Customer Pre-Installation	1 day	Tue 8/23/16	Wed 8/24/16
932	Verify equipment inventory & installation location	1 day	Tue 8/23/16	Wed 8/24/16
933	Verify electrical, network/telecom, and telephone installations meet or exceed standa	1 day	Tue 8/23/16	Wed 8/24/16
934	Complete Field Technician Checklist & return to Project Manager	1 day	Tue 8/23/16	Wed 8/24/16
935	Internal Quality Control Checkpoint: Equipment Testing / Functional Validation	1 day	Wed 8/24/16	Thu 8/25/16
936	Verify all Features working properly	1 day	Wed 8/24/16	Thu 8/25/16
937	Verify phones work, port assignments/call groups set	1 day	Wed 8/24/16	Thu 8/25/16
938	Complete Test & Validation Checklist and return to Project Manager	1 day	Wed 8/24/16	Thu 8/25/16
939	CAYUGA CORRECTIONAL FACILITY	5.38 days	Thu 8/18/16	Thu 8/25/16
940	Pre-Installation	4.38 days	Thu 8/18/16	Wed 8/24/16
941	Receipt & Pre-Install ITS/WAP Tasks	1.38 days	Thu 8/18/16	Fri 8/19/16
942	Receive Shipment at Site	1 hr	Thu 8/18/16	Thu 8/18/16
943	Verify shipment Content to Pick List	2 hrs	Thu 8/18/16	Thu 8/18/16
944	Telephone room preparation & wiring	1 day	Thu 8/18/16	Fri 8/19/16
945	Pre-Install Securus ITS/WAP equipment	1 day	Thu 8/18/16	Fri 8/19/16
946	Install ITS/WAP Phones	2 days	Fri 8/19/16	Tue 8/23/16
947	Phone room wiring and installation activity	1 day	Fri 8/19/16	Mon 8/22/16
948	Facility wiring and cross connections	1 day	Fri 8/19/16	Mon 8/22/16
949	Telephone replacements/installation in dormitories	1 day	Mon 8/22/16	Tue 8/23/16
950	Quality Control Checkpoint: Customer Pre-Installation	1 day	Tue 8/23/16	Wed 8/24/16
951	Verify equipment inventory & installation location	1 day	Tue 8/23/16	Wed 8/24/16
952	Verify electrical, network/telecom, and telephone installations meet or exceed standa	1 day	Tue 8/23/16	Wed 8/24/16
953	Complete Field Technician Checklist & return to Project Manager	1 day	Tue 8/23/16	Wed 8/24/16
954	Internal Quality Control Checkpoint: Equipment Testing / Functional Validation	1 day	Wed 8/24/16	Thu 8/25/16
955	Verify all Features working properly	1 day	Wed 8/24/16	Thu 8/25/16
956	Verify phones work, port assignments/call groups set	1 day	Wed 8/24/16	Thu 8/25/16

ID	Task Name	Duration	Start	Finish
957	Complete Test & Validation Checklist and return to Project Manager	1 day	Wed 8/24/16	Thu 8/25/16
958	Installation Region 3 Facilities	32.25 days	Tue 7/19/16	Fri 9/2/16
959	LAKEVIEW SHOCK INCARCERATION CORRECTIONAL FACILITY	5.38 days	Tue 7/19/16	Wed 7/27/16
960	Pre-Installation	4.38 days	Tue 7/19/16	Tue 7/26/16
961	Receipt & Pre-Install ITS/WAP Tasks	1.38 days	Tue 7/19/16	Thu 7/21/16
962	Receive Shipment at Site	1 hr	Tue 7/19/16	Tue 7/19/16
963	Verify shipment Content to Pick List	2 hrs	Wed 7/20/16	Wed 7/20/16
964	Telephone room preparation & wiring	1 day	Wed 7/20/16	Thu 7/21/16
965	Pre-Install Securus ITSWAP equipment	1 day	Wed 7/20/16	Thu 7/21/16
966	Install ITS/WAP Phones	2 days	Thu 7/21/16	Mon 7/25/16
967	Phone room wiring and installation activity	1 day	Thu 7/21/16	Fri 7/22/16
968	Facility wiring and cross connections	1 day	Thu 7/21/16	Fri 7/22/16
969	Telephone replacements/installation in dormitories	1 day	Fri 7/22/16	Mon 7/25/16
970	Quality Control Checkpoint: Customer Pre-Installation	1 day	Mon 7/25/16	Tue 7/26/16
971	Verify equipment inventory & installation location	1 day	Mon 7/25/16	Tue 7/26/16
972	Verify electrical, network/telecom, and telephone installations meet or exceed standa	1 day	Mon 7/25/16	Tue 7/26/16
973	Complete Field Technician Checklist & return to Project Manager	1 day	Mon 7/25/16	Tue 7/26/16
974	Internal Quality Control Checkpoint: Equipment Testing / Functional Validation	1 day	Tue 7/26/16	Wed 7/27/16
975	Verify all Features working properly	1 day	Tue 7/26/16	Wed 7/27/16
976	Verify phones work, port assignments/call groups set	1 day	Tue 7/26/16	Wed 7/27/16
977	Complete Test & Validation Checklist and return to Project Manager	1 day	Tue 7/26/16	Wed 7/27/16
978	GOWANDA CORRECTIONAL FACILITY	5.38 days	Tue 7/19/16	Wed 7/27/16
979	Pre-Installation	4.38 days	Tue 7/19/16	Tue 7/26/16
980	Receipt & Pre-Install ITS/WAP Tasks	1.38 days	Tue 7/19/16	Thu 7/21/16
981	Receive Shipment at Site	1 hr	Tue 7/19/16	Tue 7/19/16
982	Verify shipment Content to Pick List	2 hrs	Wed 7/20/16	Wed 7/20/16
983	Telephone room preparation & wiring	1 day	Wed 7/20/16	Thu 7/21/16
984	Pre-Install Securus ITSWAP equipment	1 day	Wed 7/20/16	Thu 7/21/16
985	Install ITS/WAP Phones	2 days	Thu 7/21/16	Mon 7/25/16
986	Phone room wiring and installation activity	1 day	Thu 7/21/16	Fri 7/22/16
987	Facility wiring and cross connections	1 day	Thu 7/21/16	Fri 7/22/16
988	Telephone replacements/installation in dormitories	1 day	Fri 7/22/16	Mon 7/25/16
989	Quality Control Checkpoint: Customer Pre-Installation	1 day	Mon 7/25/16	Tue 7/26/16
990	Verify equipment inventory & installation location	1 day	Mon 7/25/16	Tue 7/26/16
991	Verify electrical, network/telecom, and telephone installations meet or exceed standa	1 day	Mon 7/25/16	Tue 7/26/16
992	Complete Field Technician Checklist & return to Project Manager	1 day	Mon 7/25/16	Tue 7/26/16
993	Internal Quality Control Checkpoint: Equipment Testing / Functional Validation	1 day	Tue 7/26/16	Wed 7/27/16

ID	Task Name	Duration	Start	Finish
994	Verify all Features working properly	1 day	Tue 7/26/16	Wed 7/27/16
995	Verify phones work, port assignments/call groups set	1 day	Tue 7/26/16	Wed 7/27/16
996	Complete Test & Validation Checklist and return to Project Manager	1 day	Tue 7/26/16	Wed 7/27/16
997	COLLINS CORRECTIONAL FACILITY	5.38 days	Tue 7/19/16	Wed 7/27/16
998	Pre-Installation	4.38 days	Tue 7/19/16	Tue 7/26/16
999	Receipt & Pre-Install ITS/WAP Tasks	1.38 days	Tue 7/19/16	Thu 7/21/16
1000	Receive Shipment at Site	1 hr	Tue 7/19/16	Tue 7/19/16
1001	Verify shipment Content to Pick List	2 hrs	Wed 7/20/16	Wed 7/20/16
1002	Telephone room preparation & wiring	1 day	Wed 7/20/16	Thu 7/21/16
1003	Pre-Install Securus ITS/WAP equipment	1 day	Wed 7/20/16	Thu 7/21/16
1004	Install ITS/WAP Phones	2 days	Thu 7/21/16	Mon 7/25/16
1005	Phone room wiring and installation activity	1 day	Thu 7/21/16	Fri 7/22/16
1006	Facility wiring and cross connections	1 day	Thu 7/21/16	Fri 7/22/16
1007	Telephone replacements/Installation in dormitories	1 day	Fri 7/22/16	Mon 7/25/16
1008	Quality Control Checkpoint: Customer Pre-Installation	1 day	Mon 7/25/16	Tue 7/26/16
1009	Verify equipment inventory & installation location	1 day	Mon 7/25/16	Tue 7/26/16
1010	Verify electrical, network/telecom, and telephone installations meet or exceed standa	1 day	Mon 7/25/16	Tue 7/26/16
1011	Complete Field Technician Checklist & return to Project Manager	1 day	Mon 7/25/16	Tue 7/26/16
1012	Internal Quality Control Checkpoint: Equipment Testing / Functional Validation	1 day	Tue 7/26/16	Wed 7/27/16
1013	Verify all Features working properly	1 day	Tue 7/26/16	Wed 7/27/16
1014	Verify phones work, port assignments/call groups set	1 day	Tue 7/26/16	Wed 7/27/16
1015	Complete Test & Validation Checklist and return to Project Manager	1 day	Tue 7/26/16	Wed 7/27/16
1016	WENDE CORRECTIONAL FACILITY	5.38 days	Wed 7/27/16	Wed 8/3/16
1017	Pre-Installation	4.38 days	Wed 7/27/16	Tue 8/2/16
1018	Receipt & Pre-Install ITS/WAP Tasks	1.38 days	Wed 7/27/16	Thu 7/28/16
1019	Receive Shipment at Site	1 hr	Wed 7/27/16	Wed 7/27/16
1020	Verify shipment Content to Pick List	2 hrs	Wed 7/27/16	Wed 7/27/16
1021	Telephone room preparation & wiring	1 day	Wed 7/27/16	Thu 7/28/16
1022	Pre-Install Securus ITS/WAP equipment	1 day	Wed 7/27/16	Thu 7/28/16
1023	Install ITS/WAP Phones	2 days	Thu 7/28/16	Mon 8/1/16
1024	Phone room wiring and installation activity	1 day	Thu 7/28/16	Fri 7/29/16
1025	Facility wiring and cross connections	1 day	Thu 7/28/16	Fri 7/29/16
1026	Telephone replacements/Installation in dormitories	1 day	Fri 7/29/16	Mon 8/1/16
1027	Quality Control Checkpoint: Customer Pre-Installation	1 day	Mon 8/1/16	Tue 8/2/16
1028	Verify equipment inventory & installation location	1 day	Mon 8/1/16	Tue 8/2/16
1029	Verify electrical, network/telecom, and telephone installations meet or exceed standa	1 day	Mon 8/1/16	Tue 8/2/16
1030	Complete Field Technician Checklist & return to Project Manager	1 day	Mon 8/1/16	Tue 8/2/16

ID	Task Name	Duration	Start	Finish
1031	Internal Quality Control Checkpoint: Equipment Testing / Functional Validation	1 day	Tue 8/2/16	Wed 8/3/16
1032	Verify all Features working properly	1 day	Tue 8/2/16	Wed 8/3/16
1033	Verify phones work, port assignments/call groups set	1 day	Tue 8/2/16	Wed 8/3/16
1034	Complete Test & Validation Checklist and return to Project Manager	1 day	Tue 8/2/16	Wed 8/3/16
1035	ATTICA CORRECTIONAL FACILITY	5.38 days	Wed 7/27/16	Wed 8/3/16
1036	Pre-Installation	4.38 days	Wed 7/27/16	Tue 8/2/16
1037	Receipt & Pre-Install ITS/WAP Tasks	1.38 days	Wed 7/27/16	Thu 7/28/16
1038	Receive Shipment at Site	1 hr	Wed 7/27/16	Wed 7/27/16
1039	Verify shipment Content to Pick List	2 hrs	Wed 7/27/16	Wed 7/27/16
1040	Telephone room preparation & wiring	1 day	Wed 7/27/16	Thu 7/28/16
1041	Pre-Install Securus ITS/WAP equipment	1 day	Wed 7/27/16	Thu 7/28/16
1042	Install ITS/WAP Phones	2 days	Thu 7/28/16	Mon 8/1/16
1043	Phone room wiring and installation activity	1 day	Thu 7/28/16	Fri 7/29/16
1044	Facility wiring and cross connections	1 day	Thu 7/28/16	Fri 7/29/16
1045	Telephone replacements/installation in dormitories	1 day	Fri 7/29/16	Mon 8/1/16
1046	Quality Control Checkpoint: Customer Pre-Installation	1 day	Mon 8/1/16	Tue 8/2/16
1047	Verify equipment inventory & installation location	1 day	Mon 8/1/16	Tue 8/2/16
1048	Verify electrical, network/telecom, and telephone installations meet or exceed standa	1 day	Mon 8/1/16	Tue 8/2/16
1049	Complete Field Technician Checklist & return to Project Manager	1 day	Mon 8/1/16	Tue 8/2/16
1050	Internal Quality Control Checkpoint: Equipment Testing / Functional Validation	1 day	Tue 8/2/16	Wed 8/3/16
1051	Verify all Features working properly	1 day	Tue 8/2/16	Wed 8/3/16
1052	Verify phones work, port assignments/call groups set	1 day	Tue 8/2/16	Wed 8/3/16
1053	Complete Test & Validation Checklist and return to Project Manager	1 day	Tue 8/2/16	Wed 8/3/16
1054	WYOMING CORRECTIONAL FACILITY	5.38 days	Wed 7/27/16	Wed 8/3/16
1055	Pre-Installation	4.38 days	Wed 7/27/16	Tue 8/2/16
1056	Receipt & Pre-Install ITS/WAP Tasks	1.38 days	Wed 7/27/16	Thu 7/28/16
1057	Receive Shipment at Site	1 hr	Wed 7/27/16	Wed 7/27/16
1058	Verify shipment Content to Pick List	2 hrs	Wed 7/27/16	Wed 7/27/16
1059	Telephone room preparation & wiring	1 day	Wed 7/27/16	Thu 7/28/16
1060	Pre-Install Securus ITS/WAP equipment	1 day	Wed 7/27/16	Thu 7/28/16
1061	Install ITS/WAP Phones	2 days	Thu 7/28/16	Mon 8/1/16
1062	Phone room wiring and installation activity	1 day	Thu 7/28/16	Fri 7/29/16
1063	Facility wiring and cross connections	1 day	Thu 7/28/16	Fri 7/29/16
1064	Telephone replacements/installation in dormitories	1 day	Fri 7/29/16	Mon 8/1/16
1065	Quality Control Checkpoint: Customer Pre-Installation	1 day	Mon 8/1/16	Tue 8/2/16
1066	Verify equipment inventory & installation location	1 day	Mon 8/1/16	Tue 8/2/16
1067	Verify electrical, network/telecom, and telephone installations meet or exceed standa	1 day	Mon 8/1/16	Tue 8/2/16

ID	Task Name	Duration	Start	Finish
1068	Complete Field Technician Checklist & return to Project Manager	1 day	Mon 8/1/16	Tue 8/2/16
1069	Internal Quality Control Checkpoint: Equipment Testing / Functional Validation	1 day	Tue 8/2/16	Wed 8/3/16
1070	Verify all Features working properly	1 day	Tue 8/2/16	Wed 8/3/16
1071	Verify phones work, port assignments/call groups set	1 day	Tue 8/2/16	Wed 8/3/16
1072	Complete Test & Validation Checklist and return to Project Manager	1 day	Tue 8/2/16	Wed 8/3/16
1073	ORLEANS CORRECTIONAL FACILITY	5.38 days	Wed 8/3/16	Wed 8/10/16
1074	Pre-Installation	4.38 days	Wed 8/3/16	Tue 8/9/16
1075	Receipt & Pre-Install ITS/WAP Tasks	1.38 days	Wed 8/3/16	Thu 8/4/16
1076	Receive Shipment at Site	1 hr	Wed 8/3/16	Wed 8/3/16
1077	Verify shipment Content to Pick List	2 hrs	Wed 8/3/16	Wed 8/3/16
1078	Telephone room preparation & wiring	1 day	Thu 8/4/16	Thu 8/4/16
1079	Pre-Install Securus ITS/WAP equipment	1 day	Thu 8/4/16	Thu 8/4/16
1080	Install ITS/WAP Phones	2 days	Fri 8/5/16	Mon 8/8/16
1081	Phone room wiring and installation activity	1 day	Fri 8/5/16	Fri 8/5/16
1082	Facility wiring and cross connections	1 day	Fri 8/5/16	Fri 8/5/16
1083	Telephone replacements/installation in dormitories	1 day	Mon 8/8/16	Mon 8/8/16
1084	Quality Control Checkpoint: Customer Pre-Installation	1 day	Tue 8/9/16	Tue 8/9/16
1085	Verify equipment inventory & installation location	1 day	Tue 8/9/16	Tue 8/9/16
1086	Verify electrical network/telecom, and telephone installations meet or exceed standa	1 day	Tue 8/9/16	Tue 8/9/16
1087	Complete Field Technician Checklist & return to Project Manager	1 day	Tue 8/9/16	Tue 8/9/16
1088	Internal Quality Control Checkpoint: Equipment Testing / Functional Validation	1 day	Wed 8/10/16	Wed 8/10/16
1089	Verify all Features working properly	1 day	Wed 8/10/16	Wed 8/10/16
1090	Verify phones work, port assignments/call groups set	1 day	Wed 8/10/16	Wed 8/10/16
1091	Complete Test & Validation Checklist and return to Project Manager	1 day	Wed 8/10/16	Wed 8/10/16
1092	ALBION CORRECTIONAL FACILITY	5.38 days	Wed 8/3/16	Wed 8/10/16
1093	Pre-Installation	4.38 days	Wed 8/3/16	Tue 8/9/16
1094	Receipt & Pre-Install ITS/WAP Tasks	1.38 days	Wed 8/3/16	Thu 8/4/16
1095	Receive Shipment at Site	1 hr	Wed 8/3/16	Wed 8/3/16
1096	Verify shipment Content to Pick List	2 hrs	Wed 8/3/16	Wed 8/3/16
1097	Telephone room preparation & wiring	1 day	Thu 8/4/16	Thu 8/4/16
1098	Pre-Install Securus ITS/WAP equipment	1 day	Thu 8/4/16	Thu 8/4/16
1099	Install ITS/WAP Phones	2 days	Fri 8/5/16	Mon 8/8/16
1100	Phone room wiring and installation activity	1 day	Fri 8/5/16	Fri 8/5/16
1101	Facility wiring and cross connections	1 day	Fri 8/5/16	Fri 8/5/16
1102	Telephone replacements/installation in dormitories	1 day	Mon 8/8/16	Mon 8/8/16
1103	Quality Control Checkpoint: Customer Pre-Installation	1 day	Tue 8/9/16	Tue 8/9/16
1104	Verify equipment inventory & installation location	1 day	Tue 8/9/16	Tue 8/9/16

ID	Task Name	Duration	Start	Finish
1105	Verify electrical, network/telecom, and telephone installations meet or exceed standa	1 day	Tue 8/9/16	Tue 8/9/16
1106	Complete Field Technician Checklist & return to Project Manager	1 day	Tue 8/9/16	Tue 8/9/16
1107	Internal Quality Control Checkpoint: Equipment Testing / Functional Validation	1 day	Wed 8/10/16	Wed 8/10/16
1108	Verify all Features working properly	1 day	Wed 8/10/16	Wed 8/10/16
1109	Verify phones work, port assignments/call groups set	1 day	Wed 8/10/16	Wed 8/10/16
1110	Complete Test & Validation Checklist and return to Project Manager	1 day	Wed 8/10/16	Wed 8/10/16
1111	ROCHESTER CORRECTIONAL FACILITY	5.38 days	Wed 8/3/16	Wed 8/10/16
1112	Pre-Installation	4.38 days	Wed 8/3/16	Tue 8/9/16
1113	Receipt & Pre-Install ITS/WAP Tasks	1.38 days	Wed 8/3/16	Thu 8/4/16
1114	Receive Shipment at Site	1 hr	Wed 8/3/16	Wed 8/3/16
1115	Verify shipment Content to Pick List	2 hrs	Wed 8/3/16	Wed 8/3/16
1116	Telephone room preparation & wiring	1 day	Thu 8/4/16	Thu 8/4/16
1117	Pre-Install Securus ITS/WAP equipment	1 day	Thu 8/4/16	Thu 8/4/16
1118	Install ITS/WAP Phones	2 days	Fri 8/5/16	Mon 8/8/16
1119	Phone room wiring and installation activity	1 day	Fri 8/5/16	Fri 8/5/16
1120	Facility wiring and cross connections	1 day	Fri 8/5/16	Fri 8/5/16
1121	Telephone replacements/installation in dormitories	1 day	Mon 8/8/16	Mon 8/8/16
1122	Quality Control Checkpoint: Customer Pre-Installation	1 day	Tue 8/9/16	Tue 8/9/16
1123	Verify equipment inventory & installation location	1 day	Tue 8/9/16	Tue 8/9/16
1124	Verify electrical, network/telecom, and telephone installations meet or exceed standa	1 day	Tue 8/9/16	Tue 8/9/16
1125	Complete Field Technician Checklist & return to Project Manager	1 day	Tue 8/9/16	Tue 8/9/16
1126	Internal Quality Control Checkpoint: Equipment Testing / Functional Validation	1 day	Wed 8/10/16	Wed 8/10/16
1127	Verify all Features working properly	1 day	Wed 8/10/16	Wed 8/10/16
1128	Verify phones work, port assignments/call groups set	1 day	Wed 8/10/16	Wed 8/10/16
1129	Complete Test & Validation Checklist and return to Project Manager	1 day	Wed 8/10/16	Wed 8/10/16
1130	LIVINGSTON CORRECTIONAL FACILITY	5.38 days	Thu 8/11/16	Thu 8/18/16
1131	Pre-Installation	4.38 days	Thu 8/11/16	Wed 8/17/16
1132	Receipt & Pre-Install ITS/WAP Tasks	1.38 days	Thu 8/11/16	Fri 8/12/16
1133	Receive Shipment at Site	1 hr	Thu 8/11/16	Thu 8/11/16
1134	Verify shipment Content to Pick List	2 hrs	Thu 8/11/16	Thu 8/11/16
1135	Telephone room preparation & wiring	1 day	Thu 8/11/16	Thu 8/12/16
1136	Pre-Install Securus ITS/WAP equipment	1 day	Thu 8/11/16	Fri 8/12/16
1137	Install ITS/WAP Phones	2 days	Fri 8/12/16	Tue 8/16/16
1138	Phone room wiring and installation activity	1 day	Fri 8/12/16	Mon 8/15/16
1139	Facility wiring and cross connections	1 day	Fri 8/12/16	Mon 8/15/16
1140	Telephone replacements/installation in dormitories	1 day	Mon 8/15/16	Tue 8/16/16
1141	Quality Control Checkpoint: Customer Pre-Installation	1 day	Tue 8/16/16	Wed 8/17/16

ID	Task Name	Duration	Start	Finish
1142	Verify equipment inventory & installation location	1 day	Tue 8/16/16	Wed 8/17/16
1143	Verify electrical, network/telecom, and telephone installations meet or exceed standa	1 day	Tue 8/16/16	Wed 8/17/16
1144	Complete Field Technician Checklist & return to Project Manager	1 day	Tue 8/16/16	Wed 8/17/16
1145	Internal Quality Control Checkpoint: Equipment Testing / Functional Validation	1 day	Wed 8/17/16	Thu 8/18/16
1146	Verify all Features working properly	1 day	Wed 8/17/16	Thu 8/18/16
1147	Verify phones work, port assignments/call groups set	1 day	Wed 8/17/16	Thu 8/18/16
1148	Complete Test & Validation Checklist and return to Project Manager	1 day	Wed 8/17/16	Thu 8/18/16
1149	GROVELAND CORRECTIONAL FACILITY	5.38 days	Thu 8/11/16	Thu 8/18/16
1150	Pre-Installation	4.38 days	Thu 8/11/16	Wed 8/17/16
1151	Receipt & Pre-Install ITS/WAP Tasks	1.38 days	Thu 8/11/16	Fri 8/12/16
1152	Receive Shipment at Site	1 hr	Thu 8/11/16	Thu 8/11/16
1153	Verify shipment Content to Pick List	2 hrs	Thu 8/11/16	Thu 8/11/16
1154	Telephone room preparation & wiring	1 day	Thu 8/11/16	Fri 8/12/16
1155	Pre-Install Securus ITSWAP equipment	1 day	Thu 8/11/16	Fri 8/12/16
1156	Install ITS/WAP Phones	2 days	Fri 8/12/16	Tue 8/16/16
1157	Phone room wiring and installation activity	1 day	Fri 8/12/16	Mon 8/15/16
1158	Facility wiring and cross connections	1 day	Fri 8/12/16	Mon 8/15/16
1159	Telephone replacements/installation in dormitories	1 day	Mon 8/15/16	Tue 8/16/16
1160	Quality Control Checkpoint: Customer Pre-Installation	1 day	Tue 8/16/16	Wed 8/17/16
1161	Verify equipment inventory & installation location	1 day	Tue 8/16/16	Wed 8/17/16
1162	Verify electrical, network/telecom, and telephone installations meet or exceed standa	1 day	Tue 8/16/16	Wed 8/17/16
1163	Complete Field Technician Checklist & return to Project Manager	1 day	Tue 8/16/16	Wed 8/17/16
1164	Internal Quality Control Checkpoint: Equipment Testing / Functional Validation	1 day	Wed 8/17/16	Thu 8/18/16
1165	Verify all Features working properly	1 day	Wed 8/17/16	Thu 8/18/16
1166	Verify phones work, port assignments/call groups set	1 day	Wed 8/17/16	Thu 8/18/16
1167	Complete Test & Validation Checklist and return to Project Manager	1 day	Wed 8/17/16	Thu 8/18/16
1168	FIVE POINTS CORRECTIONAL FACILITY	5.38 days	Thu 8/11/16	Thu 8/18/16
1169	Pre-Installation	4.38 days	Thu 8/11/16	Wed 8/17/16
1170	Receipt & Pre-Install ITS/WAP Tasks	1.38 days	Thu 8/11/16	Fri 8/12/16
1171	Receive Shipment at Site	1 hr	Thu 8/11/16	Thu 8/11/16
1172	Verify shipment Content to Pick List	2 hrs	Thu 8/11/16	Thu 8/11/16
1173	Telephone room preparation & wiring	1 day	Thu 8/11/16	Fri 8/12/16
1174	Pre-Install Securus ITSWAP equipment	1 day	Thu 8/11/16	Fri 8/12/16
1175	Install ITS/WAP Phones	2 days	Fri 8/12/16	Tue 8/16/16
1176	Phone room wiring and installation activity	1 day	Fri 8/12/16	Mon 8/15/16
1177	Facility wiring and cross connections	1 day	Fri 8/12/16	Mon 8/15/16
1178	Telephone replacements/installation in dormitories	1 day	Mon 8/15/16	Tue 8/16/16

ID	Task Name	Duration	Start	Finish
1179	Quality Control Checkpoint: Customer Pre-Installation	1 day	Tue 8/16/16	Wed 8/17/16
1180	Verify equipment inventory & installation location	1 day	Tue 8/16/16	Wed 8/17/16
1181	Verify electrical, network/telecom, and telephone installations meet or exceed standards	1 day	Tue 8/16/16	Wed 8/17/16
1182	Complete Field Technician Checklist & return to Project Manager	1 day	Tue 8/16/16	Wed 8/17/16
1183	Internal Quality Control Checkpoint: Equipment Testing / Functional Validation	1 day	Wed 8/17/16	Thu 8/18/16
1184	Verify all Features working properly	1 day	Wed 8/17/16	Thu 8/18/16
1185	Verify phones work, port assignments/call groups set	1 day	Wed 8/17/16	Thu 8/18/16
1186	Complete Test & Validation Checklist and return to Project Manager	1 day	Wed 8/17/16	Thu 8/18/16
1187	WILLARD DRUG TREATMENT CAMPUS	5.38 days	Thu 8/18/16	Thu 8/25/16
1188	Pre-Installation	4.38 days	Thu 8/18/16	Wed 8/24/16
1189	Receipt & Pre-Install ITS/WAP Tasks	1.38 days	Thu 8/18/16	Fri 8/19/16
1190	Receive Shipment at Site	1 hr	Thu 8/18/16	Thu 8/18/16
1191	Verify shipment Content to Pick List	2 hrs	Thu 8/18/16	Thu 8/18/16
1192	Telephone room preparation & wiring	1 day	Thu 8/18/16	Fri 8/19/16
1193	Pre-Install Securus ITS/WAP equipment	1 day	Thu 8/18/16	Fri 8/19/16
1194	Install ITS/WAP Phones	2 days	Fri 8/19/16	Tue 8/23/16
1195	Phone room wiring and installation activity	1 day	Fri 8/19/16	Mon 8/22/16
1196	Facility wiring and cross connections	1 day	Fri 8/19/16	Mon 8/22/16
1197	Telephone replacements/installation in dormitories	1 day	Mon 8/22/16	Tue 8/23/16
1198	Quality Control Checkpoint: Customer Pre-Installation	1 day	Tue 8/23/16	Wed 8/24/16
1199	Verify equipment inventory & installation location	1 day	Tue 8/23/16	Wed 8/24/16
1200	Verify electrical, network/telecom, and telephone installations meet or exceed standards	1 day	Tue 8/23/16	Wed 8/24/16
1201	Complete Field Technician Checklist & return to Project Manager	1 day	Tue 8/23/16	Wed 8/24/16
1202	Internal Quality Control Checkpoint: Equipment Testing / Functional Validation	1 day	Wed 8/24/16	Thu 8/25/16
1203	Verify all Features working properly	1 day	Wed 8/24/16	Thu 8/25/16
1204	Verify phones work, port assignments/call groups set	1 day	Wed 8/24/16	Thu 8/25/16
1205	Complete Test & Validation Checklist and return to Project Manager	1 day	Wed 8/24/16	Thu 8/25/16
1206	MONTEREY SHOCK INCARCERATION CORRECTIONAL FACILITY	5.38 days	Thu 8/18/16	Thu 8/25/16
1207	Pre-Installation	4.38 days	Thu 8/18/16	Wed 8/24/16
1208	Receipt & Pre-Install ITS/WAP Tasks	1.38 days	Thu 8/18/16	Fri 8/19/16
1209	Receive Shipment at Site	1 hr	Thu 8/18/16	Thu 8/18/16
1210	Verify shipment Content to Pick List	2 hrs	Thu 8/18/16	Thu 8/18/16
1211	Telephone room preparation & wiring	1 day	Thu 8/18/16	Fri 8/19/16
1212	Pre-Install Securus ITS/WAP equipment	1 day	Thu 8/18/16	Fri 8/19/16
1213	Install ITS/WAP Phones	2 days	Fri 8/19/16	Tue 8/23/16
1214	Phone room wiring and installation activity	1 day	Fri 8/19/16	Mon 8/22/16
1215	Facility wiring and cross connections	1 day	Fri 8/19/16	Mon 8/22/16

ID	Task Name	Duration	Start	Finish
1216	Telephone replacements/installation in dormitories	1 day	Mon 8/22/16	Tue 8/23/16
1217	Quality Control Checkpoint: Customer Pre-Installation	1 day	Tue 8/23/16	Wed 8/24/16
1218	Verify equipment inventory & installation location	1 day	Tue 8/23/16	Wed 8/24/16
1219	Verify electrical, network/telecom, and telephone installations meet or exceed standards	1 day	Tue 8/23/16	Wed 8/24/16
1220	Complete Field Technician Checklist & return to Project Manager	1 day	Tue 8/23/16	Wed 8/24/16
1221	Internal Quality Control Checkpoint: Equipment Testing / Functional Validation	1 day	Wed 8/24/16	Thu 8/25/16
1222	Verify all Features working properly	1 day	Wed 8/24/16	Thu 8/25/16
1223	Verify phones work, port assignments/call groups set	1 day	Wed 8/24/16	Thu 8/25/16
1224	Complete Test & Validation Checklist and return to Project Manager	1 day	Wed 8/24/16	Thu 8/25/16
1225	SOUTHPORT CORRECTIONAL FACILITY	5.38 days	Thu 8/18/16	Thu 8/25/16
1226	Pre-Installation	4.38 days	Thu 8/18/16	Wed 8/24/16
1227	Receipt & Pre-Install IT'S/WAP Tasks	1.38 days	Thu 8/18/16	Fri 8/19/16
1228	Receive Shipment at Site	1 hr	Thu 8/18/16	Thu 8/18/16
1229	Verify shipment Content to Pick List	2 hrs	Thu 8/18/16	Thu 8/18/16
1230	Telephone room preparation & wiring	1 day	Thu 8/18/16	Fri 8/19/16
1231	Pre-Install Securus IT'S/WAP equipment	1 day	Thu 8/18/16	Fri 8/19/16
1232	Install IT'S/WAP Phones	2 days	Fri 8/19/16	Tue 8/23/16
1233	Phone room wiring and installation activity	1 day	Fri 8/19/16	Mon 8/22/16
1234	Facility wiring and cross connections	1 day	Fri 8/19/16	Mon 8/22/16
1235	Telephone replacements/installation in dormitories	1 day	Mon 8/22/16	Tue 8/23/16
1236	Quality Control Checkpoint: Customer Pre-Installation	1 day	Tue 8/23/16	Wed 8/24/16
1237	Verify equipment inventory & installation location	1 day	Tue 8/23/16	Wed 8/24/16
1238	Verify electrical, network/telecom, and telephone installations meet or exceed standards	1 day	Tue 8/23/16	Wed 8/24/16
1239	Complete Field Technician Checklist & return to Project Manager	1 day	Tue 8/23/16	Wed 8/24/16
1240	Internal Quality Control Checkpoint: Equipment Testing / Functional Validation	1 day	Wed 8/24/16	Thu 8/25/16
1241	Verify all Features working properly	1 day	Wed 8/24/16	Thu 8/25/16
1242	Verify phones work, port assignments/call groups set	1 day	Wed 8/24/16	Thu 8/25/16
1243	Complete Test & Validation Checklist and return to Project Manager	1 day	Wed 8/24/16	Thu 8/25/16
1244	ELMIRA CORRECTIONAL FACILITY AND RECEPTION CENTER	5.38 days	Thu 8/25/16	Fri 9/2/16
1245	Pre-Installation	4.38 days	Thu 8/25/16	Thu 9/1/16
1246	Receipt & Pre-Install IT'S/WAP Tasks	1.38 days	Thu 8/25/16	Mon 8/29/16
1247	Receive Shipment at Site	1 hr	Thu 8/25/16	Thu 8/25/16
1248	Verify shipment Content to Pick List	2 hrs	Thu 8/25/16	Fri 8/26/16
1249	Telephone room preparation & wiring	1 day	Fri 8/26/16	Mon 8/29/16
1250	Pre-Install Securus IT'S/WAP equipment	1 day	Fri 8/26/16	Mon 8/29/16
1251	Install IT'S/WAP Phones	2 days	Mon 8/29/16	Wed 8/31/16
1252	Phone room wiring and installation activity	1 day	Mon 8/29/16	Tue 8/30/16

ID	Task Name	Duration	Start	Finish
1253	Facility wiring and cross connections	1 day	Mon 8/29/16	Tue 8/30/16
1254	Telephone replacements/installation in dormitories	1 day	Tue 8/30/16	Wed 8/31/16
1255	Quality Control Checkpoint: Customer Pre-Installation	1 day	Wed 8/31/16	Thu 9/1/16
1256	Verify equipment inventory & installation location	1 day	Wed 8/31/16	Thu 9/1/16
1257	Verify electrical, network/telecom, and telephone installations meet or exceed standards	1 day	Wed 8/31/16	Thu 9/1/16
1258	Complete Field Technician Checklist & return to Project Manager	1 day	Wed 8/31/16	Thu 9/1/16
1259	Internal Quality Control Checkpoint: Equipment Testing / Functional Validation	1 day	Thu 9/1/16	Fri 9/2/16
1260	Verify all Features working properly	1 day	Thu 9/1/16	Fri 9/2/16
1261	Verify phones work, port assignments/call groups set	1 day	Thu 9/1/16	Fri 9/2/16
1262	Complete Test & Validation Checklist and return to Project Manager	1 day	Thu 9/1/16	Fri 9/2/16
1263	Installation Region 4 Facilities	26.88 days	Tue 7/19/16	Thu 8/25/16
1264	SHAWANGUNK CORRECTIONAL FACILITY	5.38 days	Tue 7/19/16	Wed 7/27/16
1265	Pre-Installation	4.38 days	Tue 7/19/16	Tue 7/26/16
1266	Receipt & Pre-Install ITSWAP Tasks	1.38 days	Tue 7/19/16	Thu 7/21/16
1267	Receive Shipment at Site	1 hr	Tue 7/19/16	Tue 7/19/16
1268	Verify shipment Content to Pick List	2 hrs	Wed 7/20/16	Wed 7/20/16
1269	Telephone room preparation & wiring	1 day	Wed 7/20/16	Thu 7/21/16
1270	Pre-Install Securus ITSWAP equipment	1 day	Wed 7/20/16	Thu 7/21/16
1271	Install ITSWAP Phones	2 days	Thu 7/21/16	Mon 7/25/16
1272	Phone room wiring and installation activity	1 day	Thu 7/21/16	Fri 7/22/16
1273	Facility wiring and cross connections	1 day	Thu 7/21/16	Fri 7/22/16
1274	Telephone replacements/installation in dormitories	1 day	Fri 7/22/16	Mon 7/25/16
1275	Quality Control Checkpoint: Customer Pre-Installation	1 day	Mon 7/25/16	Tue 7/26/16
1276	Verify equipment inventory & installation location	1 day	Mon 7/25/16	Tue 7/26/16
1277	Verify electrical, network/telecom, and telephone installations meet or exceed standards	1 day	Mon 7/25/16	Tue 7/26/16
1278	Complete Field Technician Checklist & return to Project Manager	1 day	Mon 7/25/16	Tue 7/26/16
1279	Internal Quality Control Checkpoint: Equipment Testing / Functional Validation	1 day	Tue 7/26/16	Wed 7/27/16
1280	Verify all Features working properly	1 day	Tue 7/26/16	Wed 7/27/16
1281	Verify phones work, port assignments/call groups set	1 day	Tue 7/26/16	Wed 7/27/16
1282	Complete Test & Validation Checklist and return to Project Manager	1 day	Tue 7/26/16	Wed 7/27/16
1283	WALLKILL CORRECTIONAL FACILITY	5.38 days	Tue 7/19/16	Wed 7/27/16
1284	Pre-Installation	4.38 days	Tue 7/19/16	Wed 7/26/16
1285	Receipt & Pre-Install ITSWAP Tasks	1.38 days	Tue 7/19/16	Thu 7/21/16
1286	Receive Shipment at Site	1 hr	Tue 7/19/16	Tue 7/19/16
1287	Verify shipment Content to Pick List	2 hrs	Wed 7/20/16	Wed 7/20/16
1288	Telephone room preparation & wiring	1 day	Wed 7/20/16	Thu 7/21/16
1289	Pre-Install Securus ITSWAP equipment	1 day	Wed 7/20/16	Thu 7/21/16

ID	Task Name	Duration	Start	Finish
1290	Install ITS/WAP Phones	2 days	Thu 7/21/16	Mon 7/25/16
1291	Phone room wiring and installation activity	1 day	Thu 7/21/16	Fri 7/22/16
1292	Facility wiring and cross connections	1 day	Thu 7/21/16	Fri 7/22/16
1293	Telephone replacements/installation in dormitories	1 day	Fri 7/22/16	Mon 7/25/16
1294	Quality Control Checkpoint: Customer Pre-Installation	1 day	Mon 7/25/16	Tue 7/26/16
1295	Verify equipment inventory & installation location	1 day	Mon 7/25/16	Tue 7/26/16
1296	Verify electrical, network/telecom, and telephone installations meet or exceed standa	1 day	Mon 7/25/16	Tue 7/26/16
1297	Complete Field Technician Checklist & return to Project Manager	1 day	Mon 7/25/16	Tue 7/26/16
1298	Internal Quality Control Checkpoint: Equipment Testing / Functional Validation	1 day	Tue 7/26/16	Wed 7/27/16
1299	Verify all Features working properly	1 day	Tue 7/26/16	Wed 7/27/16
1300	Verify phones work, port assignments/call groups set	1 day	Tue 7/26/16	Wed 7/27/16
1301	Complete Test & Validation Checklist and return to Project Manager	1 day	Tue 7/26/16	Wed 7/27/16
1302	OTISVILLE CORRECTIONAL FACILITY	5.38 days	Tue 7/19/16	Wed 7/27/16
1303	Pre-Installation	4.38 days	Tue 7/19/16	Tue 7/26/16
1304	Receipt & Pre-Install ITS/WAP Tasks	1.38 days	Tue 7/19/16	Thu 7/21/16
1305	Receive Shipment at Site	1 hr	Tue 7/19/16	Tue 7/19/16
1306	Verify shipment Content to Pick List	2 hrs	Wed 7/20/16	Wed 7/20/16
1307	Telephone room preparation & wiring	1 day	Wed 7/20/16	Thu 7/21/16
1308	Pre-Install Securus ITS/WAP equipment	1 day	Wed 7/20/16	Thu 7/21/16
1309	Install ITS/WAP Phones	2 days	Thu 7/21/16	Mon 7/25/16
1310	Phone room wiring and installation activity	1 day	Thu 7/21/16	Fri 7/22/16
1311	Facility wiring and cross connections	1 day	Thu 7/21/16	Fri 7/22/16
1312	Telephone replacements/installation in dormitories	1 day	Fri 7/22/16	Mon 7/25/16
1313	Quality Control Checkpoint: Customer Pre-Installation	1 day	Mon 7/25/16	Tue 7/26/16
1314	Verify equipment inventory & installation location	1 day	Mon 7/25/16	Tue 7/26/16
1315	Verify electrical, network/telecom, and telephone installations meet or exceed standa	1 day	Mon 7/25/16	Tue 7/26/16
1316	Complete Field Technician Checklist & return to Project Manager	1 day	Mon 7/25/16	Tue 7/26/16
1317	Internal Quality Control Checkpoint: Equipment Testing / Functional Validation	1 day	Tue 7/26/16	Wed 7/27/16
1318	Verify all Features working properly	1 day	Tue 7/26/16	Wed 7/27/16
1319	Verify phones work, port assignments/call groups set	1 day	Tue 7/26/16	Wed 7/27/16
1320	Complete Test & Validation Checklist and return to Project Manager	1 day	Tue 7/26/16	Wed 7/27/16
1321	FISHKILL CORRECTIONAL FACILITY	5.38 days	Wed 7/27/16	Wed 8/3/16
1322	Pre-Installation	4.38 days	Wed 7/27/16	Tue 8/2/16
1323	Receipt & Pre-Install ITS/WAP Tasks	1.38 days	Wed 7/27/16	Thu 7/28/16
1324	Receive Shipment at Site	1 hr	Wed 7/27/16	Wed 7/27/16
1325	Verify shipment Content to Pick List	2 hrs	Wed 7/27/16	Wed 7/27/16
1326	Telephone room preparation & wiring	1 day	Wed 7/27/16	Thu 7/28/16

ID	Task Name	Duration	Start	Finish
1327	Pre-Install Securus ITS/WAP equipment	1 day	Wed 7/27/16	Thu 7/28/16
1328	Install ITS/WAP Phones	2 days	Thu 7/28/16	Mon 8/1/16
1329	Phone room wiring and installation activity	1 day	Thu 7/28/16	Fri 7/29/16
1330	Facility wiring and cross connections	1 day	Thu 7/28/16	Fri 7/29/16
1331	Telephone replacements/installation in dormitories	1 day	Fri 7/29/16	Mon 8/1/16
1332	Quality Control Checkpoint: Customer Pre-Installation	1 day	Mon 8/1/16	Tue 8/2/16
1333	Verify equipment inventory & installation location	1 day	Mon 8/1/16	Tue 8/2/16
1334	Verify electrical, network/telecom, and telephone installations meet or exceed standa	1 day	Mon 8/1/16	Tue 8/2/16
1335	Complete Field Technician Checklist & return to Project Manager	1 day	Mon 8/1/16	Tue 8/2/16
1336	Internal Quality Control Checkpoint: Equipment Testing / Functional Validation	1 day	Tue 8/2/16	Wed 8/3/16
1337	Verify all Features working properly	1 day	Tue 8/2/16	Wed 8/3/16
1338	Verify phones work, port assignments/call groups set	1 day	Tue 8/2/16	Wed 8/3/16
1339	Complete Test & Validation Checklist and return to Project Manager	1 day	Tue 8/2/16	Wed 8/3/16
1340	BEACON CORRECTONAL FACILITY	5.38 days	Wed 7/27/16	Wed 8/3/16
1341	Pre-Installation	4.38 days	Wed 7/27/16	Tue 8/2/16
1342	Receipt & Pre-Install ITS/WAP Tasks	1.38 days	Wed 7/27/16	Thu 7/28/16
1343	Receive Shipment at Site	1 hr	Wed 7/27/16	Wed 7/27/16
1344	Verify shipment Content to Pick List	2 hrs	Wed 7/27/16	Wed 7/27/16
1345	Telephone room preparation & wiring	1 day	Wed 7/27/16	Thu 7/28/16
1346	Pre-Install Securus ITS/WAP equipment	1 day	Wed 7/27/16	Thu 7/28/16
1347	Install ITS/WAP Phones	2 days	Thu 7/28/16	Mon 8/1/16
1348	Phone room wiring and installation activity	1 day	Thu 7/28/16	Fri 7/29/16
1349	Facility wiring and cross connections	1 day	Thu 7/28/16	Fri 7/29/16
1350	Telephone replacements/installation in dormitories	1 day	Fri 7/29/16	Mon 8/1/16
1351	Quality Control Checkpoint: Customer Pre-Installation	1 day	Mon 8/1/16	Tue 8/2/16
1352	Verify equipment inventory & installation location	1 day	Mon 8/1/16	Tue 8/2/16
1353	Verify electrical, network/telecom, and telephone installations meet or exceed standa	1 day	Mon 8/1/16	Tue 8/2/16
1354	Complete Field Technician Checklist & return to Project Manager	1 day	Mon 8/1/16	Tue 8/2/16
1355	Internal Quality Control Checkpoint: Equipment Testing / Functional Validation	1 day	Tue 8/2/16	Wed 8/3/16
1356	Verify all Features working properly	1 day	Tue 8/2/16	Wed 8/3/16
1357	Verify phones work, port assignments/call groups set	1 day	Tue 8/2/16	Wed 8/3/16
1358	Complete Test & Validation Checklist and return to Project Manager	1 day	Tue 8/2/16	Wed 8/3/16
1359	DOWNSTATE CORRECTONAL FACILITY	5.38 days	Wed 7/27/16	Wed 8/3/16
1360	Pre-Installation	4.38 days	Wed 7/27/16	Tue 8/2/16
1361	Receipt & Pre-Install ITS/WAP Tasks	1.38 days	Wed 7/27/16	Thu 7/28/16
1362	Receive Shipment at Site	1 hr	Wed 7/27/16	Wed 7/27/16
1363	Verify shipment Content to Pick List	2 hrs	Wed 7/27/16	Wed 7/27/16

ID	Task Name	Duration	Start	Finish
1364	Telephone room preparation & wiring	1 day	Wed 7/27/16	Thu 7/28/16
1365	Pre-Install Securus ITSWAP equipment	1 day	Wed 7/27/16	Thu 7/28/16
1366	Install ITSWAP Phones	2 days	Thu 7/28/16	Mon 8/1/16
1367	Phone room wiring and installation activity	1 day	Thu 7/28/16	Fri 7/29/16
1368	Facility wiring and cross connections	1 day	Thu 7/28/16	Fri 7/29/16
1369	Telephone replacements/installation in dormitories	1 day	Fri 7/29/16	Mon 8/1/16
1370	Quality Control Checkpoint: Customer Pre-Installation	1 day	Mon 8/1/16	Tue 8/2/16
1371	Verify equipment inventory & installation location	1 day	Mon 8/1/16	Tue 8/2/16
1372	Verify electrical, network/telecom, and telephone installations meet or exceed standa	1 day	Mon 8/1/16	Tue 8/2/16
1373	Complete Field Technician Checklist & return to Project Manager	1 day	Mon 8/1/16	Tue 8/2/16
1374	Internal Quality Control Checkpoint: Equipment Testing / Functional Validation	1 day	Tue 8/2/16	Wed 8/3/16
1375	Verify all Features working properly	1 day	Tue 8/2/16	Wed 8/3/16
1376	Verify phones work, port assignments/call groups set	1 day	Tue 8/2/16	Wed 8/3/16
1377	Complete Test & Validation Checklist and return to Project Manager	1 day	Tue 8/2/16	Wed 8/3/16
1378	GREEN HAVEN CORRECTIONAL FACILITY	5.38 days	Wed 8/3/16	Wed 8/10/16
1379	Pre-Installation	4.38 days	Wed 8/3/16	Tue 8/9/16
1380	Receipt & Pre-Install ITSWAP Tasks	1.38 days	Wed 8/3/16	Thu 8/4/16
1381	Receive Shipment at Site	1 hr	Wed 8/3/16	Wed 8/3/16
1382	Verify shipment Content to Pick List	2 hrs	Wed 8/3/16	Wed 8/3/16
1383	Telephone room preparation & wiring	1 day	Thu 8/4/16	Thu 8/4/16
1384	Pre-Install Securus ITSWAP equipment	1 day	Thu 8/4/16	Thu 8/4/16
1385	Install ITSWAP Phones	2 days	Fri 8/5/16	Mon 8/8/16
1386	Phone room wiring and installation activity	1 day	Fri 8/5/16	Fri 8/5/16
1387	Facility wiring and cross connections	1 day	Fri 8/5/16	Fri 8/5/16
1388	Telephone replacements/installation in dormitories	1 day	Mon 8/8/16	Mon 8/8/16
1389	Quality Control Checkpoint: Customer Pre-Installation	1 day	Tue 8/9/16	Tue 8/9/16
1390	Verify equipment inventory & installation location	1 day	Tue 8/9/16	Tue 8/9/16
1391	Verify electrical, network/telecom, and telephone installations meet or exceed standa	1 day	Tue 8/9/16	Tue 8/9/16
1392	Complete Field Technician Checklist & return to Project Manager	1 day	Tue 8/9/16	Tue 8/9/16
1393	Internal Quality Control Checkpoint: Equipment Testing / Functional Validation	1 day	Wed 8/10/16	Wed 8/10/16
1394	Verify all Features working properly	1 day	Wed 8/10/16	Wed 8/10/16
1395	Verify phones work, port assignments/call groups set	1 day	Wed 8/10/16	Wed 8/10/16
1396	Complete Test & Validation Checklist and return to Project Manager	1 day	Wed 8/10/16	Wed 8/10/16
1397	TACONIC CORRECTIONAL FACILITY	5.38 days	Wed 8/3/16	Wed 8/10/16
1398	Pre-Installation	4.38 days	Wed 8/3/16	Tue 8/9/16
1399	Receipt & Pre-Install ITSWAP Tasks	1.38 days	Wed 8/3/16	Thu 8/4/16
1400	Receive Shipment at Site	1 hr	Wed 8/3/16	Wed 8/3/16

ID	Task Name	Duration	Start	Finish
1401	Verify shipment Content to Pick List	2 hrs	Wed 8/3/16	Wed 8/3/16
1402	Telephone room preparation & wiring	1 day	Thu 8/4/16	Thu 8/4/16
1403	Pre-Install Securus ITSWAP equipment	1 day	Thu 8/4/16	Thu 8/4/16
1404	Install ITSWAP Phones	2 days	Fri 8/5/16	Mon 8/8/16
1405	Phone room wiring and installation activity	1 day	Fri 8/5/16	Fri 8/5/16
1406	Facility wiring and cross connections	1 day	Fri 8/5/16	Fri 8/5/16
1407	Telephone replacements/installation in dormitories	1 day	Mon 8/8/16	Mon 8/8/16
1408	Quality Control Checkpoint: Customer Pre-Installation	1 day	Tue 8/9/16	Tue 8/9/16
1409	Verify equipment inventory & installation location	1 day	Tue 8/9/16	Tue 8/9/16
1410	Verify electrical, network/telecom, and telephone installations meet or exceed standards	1 day	Tue 8/9/16	Tue 8/9/16
1411	Complete Field Technician Checklist & return to Project Manager	1 day	Tue 8/9/16	Tue 8/9/16
1412	Internal Quality Control Checkpoint: Equipment Testing / Functional Validation	1 day	Wed 8/10/16	Wed 8/10/16
1413	Verify all Features working properly	1 day	Wed 8/10/16	Wed 8/10/16
1414	Verify phones work, port assignments/call groups set	1 day	Wed 8/10/16	Wed 8/10/16
1415	Complete Test & Validation Checklist and return to Project Manager	1 day	Wed 8/10/16	Wed 8/10/16
1416	BEDFORD HILLS CORRECTONAL FACILITY	5.38 days	Wed 8/3/16	Wed 8/10/16
1417	Pre-Installation	4.38 days	Wed 8/3/16	Tue 8/9/16
1418	Receipt & Pre-Install ITSWAP Tasks	1.38 days	Wed 8/3/16	Thu 8/4/16
1419	Receive Shipment at Site	1 hr	Wed 8/3/16	Wed 8/3/16
1420	Verify shipment Content to Pick List	2 hrs	Wed 8/3/16	Wed 8/3/16
1421	Telephone room preparation & wiring	1 day	Thu 8/4/16	Thu 8/4/16
1422	Pre-Install Securus ITSWAP equipment	1 day	Thu 8/4/16	Thu 8/4/16
1423	Install ITSWAP Phones	2 days	Fri 8/5/16	Mon 8/8/16
1424	Phone room wiring and installation activity	1 day	Fri 8/5/16	Fri 8/5/16
1425	Facility wiring and cross connections	1 day	Fri 8/5/16	Fri 8/5/16
1426	Telephone replacements/installation in dormitories	1 day	Mon 8/8/16	Mon 8/8/16
1427	Quality Control Checkpoint: Customer Pre-Installation	1 day	Tue 8/9/16	Tue 8/9/16
1428	Verify equipment inventory & installation location	1 day	Tue 8/9/16	Tue 8/9/16
1429	Verify electrical, network/telecom, and telephone installations meet or exceed standards	1 day	Tue 8/9/16	Tue 8/9/16
1430	Complete Field Technician Checklist & return to Project Manager	1 day	Tue 8/9/16	Tue 8/9/16
1431	Internal Quality Control Checkpoint: Equipment Testing / Functional Validation	1 day	Wed 8/10/16	Wed 8/10/16
1432	Verify all Features working properly	1 day	Wed 8/10/16	Wed 8/10/16
1433	Verify phones work, port assignments/call groups set	1 day	Wed 8/10/16	Wed 8/10/16
1434	Complete Test & Validation Checklist and return to Project Manager	1 day	Wed 8/10/16	Wed 8/10/16
1435	SING SING CORRECTONAL FACILITY	5.38 days	Thu 8/11/16	Thu 8/18/16
1436	Pre-Installation	4.38 days	Thu 8/11/16	Wed 8/17/16
1437	Receipt & Pre-Install ITSWAP Tasks	1.38 days	Thu 8/11/16	Fri 8/12/16

ID	Task Name	Duration	Start	Finish
1438	Receive Shipment at Site	1 hr	Thu 8/11/16	Thu 8/11/16
1439	Verify shipment Content to Pick List	2 hrs	Thu 8/11/16	Thu 8/11/16
1440	Telephone room preparation & wiring	1 day	Thu 8/11/16	Fri 8/12/16
1441	Pre-Install Securus ITSWAP equipment	1 day	Thu 8/11/16	Fri 8/12/16
1442	Install ITSWAP Phones	2 days	Fri 8/12/16	Tue 8/16/16
1443	Phone room wiring and installation activity	1 day	Fri 8/12/16	Mon 8/15/16
1444	Facility wiring and cross connections	1 day	Fri 8/12/16	Mon 8/15/16
1445	Telephone replacements/installation in dormitories	1 day	Mon 8/15/16	Tue 8/16/16
1446	Quality Control Checkpoint: Customer Pre-Installation	1 day	Tue 8/16/16	Wed 8/17/16
1447	Verify equipment inventory & installation location	1 day	Tue 8/16/16	Wed 8/17/16
1448	Verify electrical, network/telecom, and telephone installations meet or exceed standa	1 day	Tue 8/16/16	Wed 8/17/16
1449	Complete Field Technician Checklist & return to Project Manager	1 day	Tue 8/16/16	Wed 8/17/16
1450	Internal Quality Control Checkpoint: Equipment Testing / Functional Validation	1 day	Wed 8/17/16	Thu 8/18/16
1451	Verify all Features working properly	1 day	Wed 8/17/16	Thu 8/18/16
1452	Verify phones work, port assignments/call groups set	1 day	Wed 8/17/16	Thu 8/18/16
1453	Complete Test & Validation Checklist and return to Project Manager	1 day	Wed 8/17/16	Thu 8/18/16
1454	EDGEcombe RESIDENTIAL TREATMENT FACILITY			
1455	Pre-Installation	5.38 days	Thu 8/11/16	Thu 8/18/16
1456	Receipt & Pre-Install ITSWAP Tasks	4.38 days	Thu 8/11/16	Wed 8/17/16
1457	Receive Shipment at Site	1.38 days	Thu 8/11/16	Fri 8/12/16
1458	Verify shipment Content to Pick List	1 hr	Thu 8/11/16	Thu 8/11/16
1459	Telephone room preparation & wiring	2 hrs	Thu 8/11/16	Thu 8/11/16
1460	Pre-Install Securus ITSWAP equipment	1 day	Thu 8/11/16	Fri 8/12/16
1461	Install ITSWAP Phones	1 day	Fri 8/12/16	Fri 8/12/16
1462	Phone room wiring and installation activity	1 day	Fri 8/12/16	Mon 8/15/16
1463	Facility wiring and cross connections	1 day	Fri 8/12/16	Mon 8/15/16
1464	Telephone replacements/installation in dormitories	1 day	Mon 8/15/16	Tue 8/16/16
1465	Quality Control Checkpoint: Customer Pre-Installation	1 day	Tue 8/16/16	Wed 8/17/16
1466	Verify equipment inventory & installation location	1 day	Tue 8/16/16	Wed 8/17/16
1467	Verify electrical, network/telecom, and telephone installations meet or exceed standa	1 day	Tue 8/16/16	Wed 8/17/16
1468	Complete Field Technician Checklist & return to Project Manager	1 day	Tue 8/16/16	Wed 8/17/16
1469	Internal Quality Control Checkpoint: Equipment Testing / Functional Validation	1 day	Wed 8/17/16	Thu 8/18/16
1470	Verify all Features working properly	1 day	Wed 8/17/16	Thu 8/18/16
1471	Verify phones work, port assignments/call groups set	1 day	Wed 8/17/16	Thu 8/18/16
1472	Complete Test & Validation Checklist and return to Project Manager	1 day	Wed 8/17/16	Thu 8/18/16
1473	BAYVIEW CORRECTIONAL FACILITY			
1474	Pre-Installation	5.38 days	Thu 8/11/16	Thu 8/18/16
		4.38 days	Thu 8/11/16	Wed 8/17/16

ID	Task Name	Duration	Start	Finish
1475	Receipt & Pre-Install ITS/WAP Tasks	1.38 days	Thu 8/11/16	Fri 8/12/16
1476	Receive Shipment at Site	1 hr	Thu 8/11/16	Thu 8/11/16
1477	Verify shipment Content to Pick List	2 hrs	Thu 8/11/16	Thu 8/11/16
1478	Telephone room preparation & wiring	1 day	Thu 8/11/16	Fri 8/12/16
1479	Pre-Install Securus ITS/WAP equipment	1 day	Thu 8/11/16	Fri 8/12/16
1480	Install ITS/WAP Phones	2 days	Fri 8/12/16	Tue 8/16/16
1481	Phone room wiring and installation activity	1 day	Fri 8/12/16	Mon 8/15/16
1482	Facility wiring and cross connections	1 day	Fri 8/12/16	Mon 8/15/16
1483	Telephone replacements/installation in dormitories	1 day	Mon 8/15/16	Tue 8/16/16
1484	Quality Control Checkpoint: Customer Pre-Installation	1 day	Tue 8/16/16	Wed 8/17/16
1485	Verify equipment inventory & installation location	1 day	Tue 8/16/16	Wed 8/17/16
1486	Verify electrical, network/telecom, and telephone installations meet or exceed standa	1 day	Tue 8/16/16	Wed 8/17/16
1487	Complete Field Technician Checklist & return to Project Manager	1 day	Tue 8/16/16	Wed 8/17/16
1488	Internal Quality Control Checkpoint: Equipment Testing / Functional Validation	1 day	Wed 8/17/16	Thu 8/18/16
1489	Verify all Features working properly	1 day	Wed 8/17/16	Thu 8/18/16
1490	Verify phones work, port assignments/call groups set	1 day	Wed 8/17/16	Thu 8/18/16
1491	Complete Test & Validation Checklist and return to Project Manager	1 day	Wed 8/17/16	Thu 8/18/16
1492	LINCOLN CORRECTIONAL FACILITY			
1493	Pre-Installation			
1494	Receipt & Pre-Install ITS/WAP Tasks	4.38 days	Thu 8/18/16	Wed 8/24/16
1495	Receive Shipment at Site	1.38 days	Thu 8/18/16	Fri 8/19/16
1496	Verify shipment Content to Pick List	1 hr	Thu 8/18/16	Thu 8/18/16
1497	Telephone room preparation & wiring	2 hrs	Thu 8/18/16	Thu 8/18/16
1498	Pre-Install Securus ITS/WAP equipment	1 day	Thu 8/18/16	Fri 8/19/16
1499	Install ITS/WAP Phones	2 days	Fri 8/19/16	Tue 8/23/16
1500	Phone room wiring and installation activity	1 day	Fri 8/19/16	Mon 8/22/16
1501	Facility wiring and cross connections	1 day	Fri 8/19/16	Mon 8/22/16
1502	Telephone replacements/installation in dormitories	1 day	Mon 8/22/16	Tue 8/23/16
1503	Quality Control Checkpoint: Customer Pre-Installation	1 day	Tue 8/23/16	Wed 8/24/16
1504	Verify equipment inventory & installation location	1 day	Tue 8/23/16	Wed 8/24/16
1505	Verify electrical, network/telecom, and telephone installations meet or exceed standa	1 day	Tue 8/23/16	Wed 8/24/16
1506	Complete Field Technician Checklist & return to Project Manager	1 day	Tue 8/23/16	Wed 8/24/16
1507	Internal Quality Control Checkpoint: Equipment Testing / Functional Validation	1 day	Wed 8/24/16	Thu 8/25/16
1508	Verify all Features working properly	1 day	Wed 8/24/16	Thu 8/25/16
1509	Verify phones work, port assignments/call groups set	1 day	Wed 8/24/16	Thu 8/25/16
1510	Complete Test & Validation Checklist and return to Project Manager	1 day	Wed 8/24/16	Thu 8/25/16
1511	QUEENSBORO CORRECTIONAL FACILITY	5.38 days	Thu 8/18/16	Thu 8/25/16

ID	Task Name	Duration	Start	Finish
1512	Pre-Installation	4.38 days	Thu 8/18/16	Wed 8/24/16
1513	Receipt & Pre-Install IT/SWAP Tasks	1.38 days	Thu 8/18/16	Fri 8/19/16
1514	Receive Shipment at Site	1 hr	Thu 8/18/16	Thu 8/18/16
1515	Verify shipment Content to Pick List	2 hrs	Thu 8/18/16	Thu 8/18/16
1516	Telephone room preparation & wiring	1 day	Thu 8/18/16	Fri 8/19/16
1517	Pre-Install Securus IT/SWAP equipment	1 day	Thu 8/18/16	Fri 8/19/16
1518	Install IT/SWAP Phones	2 days	Fri 8/19/16	Tue 8/23/16
1519	Phone room wiring and installation activity	1 day	Fri 8/19/16	Mon 8/22/16
1520	Facility wiring and cross connections	1 day	Fri 8/19/16	Mon 8/22/16
1521	Telephone replacements/installation in dormitories	1 day	Mon 8/22/16	Tue 8/23/16
1522	Quality Control Checkpoint: Customer Pre-Installation	1 day	Tue 8/23/16	Wed 8/24/16
1523	Verify equipment inventory & installation location	1 day	Tue 8/23/16	Wed 8/24/16
1524	Verify electrical, network/telecom, and telephone installations meet or exceed standa	1 day	Tue 8/23/16	Wed 8/24/16
1525	Complete Field Technician Checklist & return to Project Manager	1 day	Tue 8/23/16	Wed 8/24/16
1526	Internal Quality Control Checkpoint: Equipment Testing / Functional Validation	1 day	Wed 8/24/16	Thu 8/25/16
1527	Verify all Features working properly	1 day	Wed 8/24/16	Thu 8/25/16
1528	Verify phones work, port assignments/call groups set	1 day	Wed 8/24/16	Thu 8/25/16
1529	Complete Test & Validation Checklist and return to Project Manager	1 day	Wed 8/24/16	Thu 8/25/16
1530	Securus & NY DOC Team Meeting - Touch Point	0.5 days	Fri 9/2/16	Fri 9/2/16
1531	Review installation progress & quality control documentation for Correctional Facility	4 hrs	Fri 9/2/16	Fri 9/2/16
1532	Discuss other ongoing and upcoming activities for remaining NY DOC installations	4 hrs	Fri 9/2/16	Fri 9/2/16
1533	Project Controlling, Monitoring, and Closing Phase	25.25 days	Wed 7/27/16	Wed 8/31/16
1534	Cut Over Implementations By Site	25.25 days	Wed 7/27/16	Wed 8/31/16
1535	Installation Region 1 Facilities	25.25 days	Wed 7/27/16	Wed 8/31/16
1536	CAPE VINCENT CORRECTIONAL FACILITY	3.75 days	Wed 7/27/16	Mon 8/1/16
1537	Transport Test & Turn-up Activities with Telecom Provider	1 day	Wed 7/27/16	Thu 7/28/16
1538	Transport turned up with Telecom Provider	1 day	Wed 7/27/16	Thu 7/28/16
1539	Circuit connected to Securus equipment	1 day	Wed 7/27/16	Thu 7/28/16
1540	Installation Support confirmation that Securus equipment on-line	1 day	Wed 7/27/16	Thu 7/28/16
1541	Cut-Over to Securus	2.31 days	Wed 7/27/16	Fri 7/29/16
1542	Re-Verify all Features working properly	0.5 hrs	Wed 7/27/16	Wed 7/27/16
1543	Re-Verify phones work, port assignments/call groups set	0.5 hrs	Wed 7/27/16	Wed 7/27/16
1544	Post Cutover QA Checklist & Test Calls Completed	0.5 hrs	Wed 7/27/16	Wed 7/27/16
1545	Notify Facility IT/SWAP is prepared for cutover and functioning correctly	0.5 hrs	Wed 7/27/16	Wed 7/27/16
1546	Cut Sheet distributed to Securus Project Team	0.5 hrs	Wed 7/27/16	Wed 7/27/16
1547	Complete and certify integration with OMS & Commissary Vendor	1 day	Wed 7/27/16	Thu 7/28/16
1548	Cut-over activities by Dorm/Offender Housing Locations	2 days	Wed 7/27/16	Fri 7/29/16

ID	Task Name	Duration	Start	Finish
1549	Quality Control Checkpoint: Customer Acceptance	1.44 days	Fri 7/29/16	Mon 8/1/16
1550	Customer walk through at facility	0.5 hrs	Fri 7/29/16	Fri 7/29/16
1551	Customer review of Quality Control documentation	0.5 hrs	Fri 7/29/16	Fri 7/29/16
1552	Post Cut-over Activities	1.38 days	Fri 7/29/16	Mon 8/1/16
1553	Final installation diagrams (datacom, electrical, and equipment diagrams)	1 hr	Fri 7/29/16	Fri 7/29/16
1554	Site Cutover Preparation Complete - Ready for Training	1 hr	Fri 7/29/16	Fri 7/29/16
1555	Distribute Implementation Customer Satisfaction Survey	1 hr	Fri 7/29/16	Fri 7/29/16
1556	Training	1 day	Mon 8/1/16	Mon 8/1/16
1557	Onsite Customer ITS/WAP Instructor Led Training	1 day	Mon 8/1/16	Mon 8/1/16
1558	Complete and distribute Training Review forms	1 day	Mon 8/1/16	Mon 8/1/16
1559	Customer Acceptance for NY DOC Correctional Facility	1 day	Mon 8/1/16	Mon 8/1/16
1560	WATERTOWN CORRECTIONAL FACILITY	3.75 days	Wed 7/27/16	Mon 8/1/16
1561	Transport Test & Turn-up Activities with Telecom Provider	1 day	Wed 7/27/16	Thu 7/28/16
1562	Transport turned up with Telecom Provider	1 day	Wed 7/27/16	Thu 7/28/16
1563	Circuit connected to Securus equipment	1 day	Wed 7/27/16	Thu 7/28/16
1564	Installation Support confirmation that Securus equipment on-line	1 day	Wed 7/27/16	Thu 7/28/16
1565	Cut-Over to Securus	2.31 days	Wed 7/27/16	Fri 7/29/16
1566	Re-Verify all Features working properly	0.5 hrs	Wed 7/27/16	Wed 7/27/16
1567	Re-Verify phones work, port assignments/call groups set	0.5 hrs	Wed 7/27/16	Wed 7/27/16
1568	Post Cutover QA Checklist & Test Calls Completed	0.5 hrs	Wed 7/27/16	Wed 7/27/16
1569	Notify Facility ITS/WAP is prepared for cutover and functioning correctly	0.5 hrs	Wed 7/27/16	Wed 7/27/16
1570	Cut Sheet distributed to Securus Project Team	0.5 hrs	Wed 7/27/16	Wed 7/27/16
1571	Complete and certify integration with OMS & Commissary Vendor	1 day	Wed 7/27/16	Thu 7/28/16
1572	Cut-over activities by Dorm/Offender Housing Locations	2 days	Wed 7/27/16	Fri 7/29/16
1573	Quality Control Checkpoint: Customer Acceptance	1.44 days	Fri 7/29/16	Mon 8/1/16
1574	Customer walk through at facility	0.5 hrs	Fri 7/29/16	Fri 7/29/16
1575	Customer review of Quality Control documentation	0.5 hrs	Fri 7/29/16	Fri 7/29/16
1576	Post Cut-over Activities	1.38 days	Fri 7/29/16	Mon 8/1/16
1577	Final installation diagrams (datacom, electrical, and equipment diagrams)	1 hr	Fri 7/29/16	Fri 7/29/16
1578	Site Cutover Preparation Complete - Ready for Training	1 hr	Fri 7/29/16	Fri 7/29/16
1579	Distribute Implementation Customer Satisfaction Survey	1 hr	Fri 7/29/16	Fri 7/29/16
1580	Training	1 day	Mon 8/1/16	Mon 8/1/16
1581	Onsite Customer ITS/WAP Instructor Led Training	1 day	Mon 8/1/16	Mon 8/1/16
1582	Complete and distribute Training Review forms	1 day	Mon 8/1/16	Mon 8/1/16
1583	Customer Acceptance for NY DOC Correctional Facility	1 day	Mon 8/1/16	Mon 8/1/16
1584	GOUVERNEUR CORRECTIONAL FACILITY	3.75 days	Wed 7/27/16	Mon 8/1/16
1585	Transport Test & Turn-up Activities with Telecom Provider	1 day	Wed 7/27/16	Thu 7/28/16

ID	Task Name	Duration	Start	Finish
1586	Transport turned up with Telecom Provider	1 day	Wed 7/27/16	Thu 7/28/16
1587	Circuit connected to Securus equipment	1 day	Wed 7/27/16	Thu 7/28/16
1588	Installation Support confirmation that Securus equipment on-line	1 day	Wed 7/27/16	Thu 7/28/16
1589	Cut-Over to Securus	2.31 days	Wed 7/27/16	Fri 7/29/16
1590	Re-Verify all Features working properly	0.5 hrs	Wed 7/27/16	Wed 7/27/16
1591	Re-Verify phones work, port assignments/call groups set	0.5 hrs	Wed 7/27/16	Wed 7/27/16
1592	Post Cutover QA Checklist & Test Calls Completed	0.5 hrs	Wed 7/27/16	Wed 7/27/16
1593	Notify Facility ITS/WAP is prepared for cutover and functioning correctly	0.5 hrs	Wed 7/27/16	Wed 7/27/16
1594	Cut Sheet distributed to Securus Project Team	0.5 hrs	Wed 7/27/16	Wed 7/27/16
1595	Complete and certify integration with OMS & Commissary Vendor	1 day	Wed 7/27/16	Thu 7/28/16
1596	Cut-over activities by Dorm/Offender Housing Locations	2 days	Wed 7/27/16	Fri 7/29/16
1597	Quality Control Checkpoint: Customer Acceptance	1.44 days	Fri 7/29/16	Mon 8/1/16
1598	Customer walk through at facility	0.5 hrs	Fri 7/29/16	Fri 7/29/16
1599	Customer review of Quality Control documentation	0.5 hrs	Fri 7/29/16	Fri 7/29/16
1600	Post Cut-over Activities	1.38 days	Fri 7/29/16	Mon 8/1/16
1601	Final installation diagrams (datacom, electrical, and equipment diagrams)	1 hr	Fri 7/29/16	Fri 7/29/16
1602	Site Cutover Preparation Complete - Ready for Training	1 hr	Fri 7/29/16	Fri 7/29/16
1603	Distribute Implementation Customer Satisfaction Survey	1 hr	Fri 7/29/16	Fri 7/29/16
1604	Training	1 day	Mon 8/1/16	Mon 8/1/16
1605	Onsite Customer ITS/WAP Instructor Led Training	1 day	Mon 8/1/16	Mon 8/1/16
1606	Complete and distribute Training Review forms	1 day	Mon 8/1/16	Mon 8/1/16
1607	Customer Acceptance for NY DOC Correctional Facility	1 day	Mon 8/1/16	Mon 8/1/16
1608	RIVERVIEW CORRECTIONAL FACILITY	3.75 days	Wed 8/3/16	Tue 8/9/16
1609	Transport Test & Turn-up Activities with Telecom Provider	1 day	Wed 8/3/16	Thu 8/4/16
1610	Transport turned up with Telecom Provider	1 day	Wed 8/3/16	Thu 8/4/16
1611	Circuit connected to Securus equipment	1 day	Wed 8/3/16	Thu 8/4/16
1612	Installation Support confirmation that Securus equipment on-line	1 day	Wed 8/3/16	Thu 8/4/16
1613	Cut-Over to Securus	2.31 days	Wed 8/3/16	Fri 8/5/16
1614	Re-Verify all Features working properly	0.5 hrs	Wed 8/3/16	Wed 8/3/16
1615	Re-Verify phones work, port assignments/call groups set	0.5 hrs	Wed 8/3/16	Wed 8/3/16
1616	Post Cutover QA Checklist & Test Calls Completed	0.5 hrs	Wed 8/3/16	Wed 8/3/16
1617	Notify Facility ITS/WAP is prepared for cutover and functioning correctly	0.5 hrs	Wed 8/3/16	Wed 8/3/16
1618	Cut Sheet distributed to Securus Project Team	0.5 hrs	Wed 8/3/16	Wed 8/3/16
1619	Complete and certify integration with OMS & Commissary Vendor	1 day	Wed 8/3/16	Thu 8/4/16
1620	Cut-over activities by Dorm/Offender Housing Locations	2 days	Wed 8/3/16	Fri 8/5/16
1621	Quality Control Checkpoint: Customer Acceptance	1.44 days	Fri 8/5/16	Tue 8/9/16
1622	Customer walk through at facility	0.5 hrs	Fri 8/5/16	Fri 8/5/16

ID	Task Name	Duration	Start	Finish
1623	Customer review of Quality Control documentation	0.5 hrs	Fri 8/5/16	Fri 8/5/16
1624	Post Cut-over Activities	1.38 days	Mon 8/8/16	Tue 8/9/16
1625	Final installation diagrams (datacom, electrical, and equipment diagrams)	1 hr	Mon 8/8/16	Mon 8/8/16
1626	Site Cutover Preparation Complete - Ready for Training	1 hr	Mon 8/8/16	Mon 8/8/16
1627	Distribute Implementation Customer Satisfaction Survey	1 hr	Mon 8/8/16	Mon 8/8/16
1628	Training	1 day	Mon 8/8/16	Tue 8/9/16
1629	Onsite Customer ITS/WAP Instructor Led Training	1 day	Mon 8/8/16	Tue 8/9/16
1630	Complete and distribute Training Review forms	1 day	Mon 8/8/16	Tue 8/9/16
1631	Customer Acceptance for NY DOC Correctional Facility	1 day	Mon 8/8/16	Tue 8/9/16
1632	OGDENSBURG CORRECTIONAL FACILITY	3.75 days	Wed 8/3/16	Tue 8/9/16
1633	Transport Test & Turn-up Activities with Telecom Provider	1 day	Wed 8/3/16	Thu 8/4/16
1634	Transport turned up with Telecom Provider	1 day	Wed 8/3/16	Thu 8/4/16
1635	Circuit connected to Securus equipment	1 day	Wed 8/3/16	Thu 8/4/16
1636	Installation Support confirmation that Securus equipment on-line	1 day	Wed 8/3/16	Thu 8/4/16
1637	Cut-Over to Securus	2.31 days	Wed 8/3/16	Fri 8/5/16
1638	Re-Verify all Features working properly	0.5 hrs	Wed 8/3/16	Wed 8/3/16
1639	Re-Verify phones work, port assignments/call groups set	0.5 hrs	Wed 8/3/16	Wed 8/3/16
1640	Post Cutover QA Checklist & Test Calls Completed	0.5 hrs	Wed 8/3/16	Wed 8/3/16
1641	Notify Facility ITS/WAP is prepared for cutover and functioning correctly	0.5 hrs	Wed 8/3/16	Wed 8/3/16
1642	Cut Sheet distributed to Securus Project Team	0.5 hrs	Wed 8/3/16	Wed 8/3/16
1643	Complete and certify integration with OMS & Commissary Vendor	1 day	Wed 8/3/16	Thu 8/4/16
1644	Cut-over activities by Dorm/Offender Housing Locations	2 days	Wed 8/3/16	Fri 8/5/16
1645	Quality Control Checkpoint: Customer Acceptance	1.44 days	Fri 8/5/16	Tue 8/9/16
1646	Customer walk through at facility	0.5 hrs	Fri 8/5/16	Fri 8/5/16
1647	Customer review of Quality Control documentation	0.5 hrs	Fri 8/5/16	Fri 8/5/16
1648	Post Cut-over Activities	1.38 days	Mon 8/8/16	Tue 8/9/16
1649	Final installation diagrams (datacom, electrical, and equipment diagrams)	1 hr	Mon 8/8/16	Mon 8/8/16
1650	Site Cutover Preparation Complete - Ready for Training	1 hr	Mon 8/8/16	Mon 8/8/16
1651	Distribute Implementation Customer Satisfaction Survey	1 hr	Mon 8/8/16	Mon 8/8/16
1652	Training	1 day	Mon 8/8/16	Tue 8/9/16
1653	Onsite Customer ITS/WAP Instructor Led Training	1 day	Mon 8/8/16	Tue 8/9/16
1654	Complete and distribute Training Review forms	1 day	Mon 8/8/16	Tue 8/9/16
1655	Customer Acceptance for NY DOC Correctional Facility	1 day	Mon 8/8/16	Tue 8/9/16
1656	FRANKLIN CORRECTIONAL FACILITY	3.75 days	Wed 8/3/16	Tue 8/9/16
1657	Transport Test & Turn-up Activities with Telecom Provider	1 day	Wed 8/3/16	Thu 8/4/16
1658	Transport turned up with Telecom Provider	1 day	Wed 8/3/16	Thu 8/4/16
1659	Circuit connected to Securus equipment	1 day	Wed 8/3/16	Thu 8/4/16

ID	Task Name	Duration	Start	Finish
1660	Installation Support confirmation that Securus equipment on-line	1 day	Wed 8/3/16	Thu 8/4/16
1661	Cut-Over to Securus	2.31 days	Wed 8/3/16	Fri 8/5/16
1662	Re-Verify all Features working properly	0.5 hrs	Wed 8/3/16	Wed 8/3/16
1663	Re-Verify phones work, port assignments/call groups set	0.5 hrs	Wed 8/3/16	Wed 8/3/16
1664	Post Cutover QA Checklist & Test Calls Completed	0.5 hrs	Wed 8/3/16	Wed 8/3/16
1665	Notify Facility ITS/WAP is prepared for cutover and functioning correctly	0.5 hrs	Wed 8/3/16	Wed 8/3/16
1666	Cut Sheet distributed to Securus Project Team	0.5 hrs	Wed 8/3/16	Wed 8/3/16
1667	Complete and certify integration with OMS & Commissary Vendor	1 day	Wed 8/3/16	Thu 8/4/16
1668	Cut-over activities by Dorm/Offender Housing Locations	2 days	Wed 8/3/16	Fri 8/5/16
1669	Quality Control Checkpoint: Customer Acceptance	1.44 days	Fri 8/5/16	Tue 8/9/16
1670	Customer walk through at facility	0.5 hrs	Fri 8/5/16	Fri 8/5/16
1671	Customer review of Quality Control documentation	0.5 hrs	Fri 8/5/16	Fri 8/5/16
1672	Post Cut-over Activities	1.38 days	Mon 8/8/16	Tue 8/9/16
1673	Final installation diagrams (datacom, electrical, and equipment diagrams)	1 hr	Mon 8/8/16	Mon 8/8/16
1674	Site Cutover Preparation Complete - Ready for Training	1 hr	Mon 8/8/16	Mon 8/8/16
1675	Distribute Implementation Customer Satisfaction Survey	1 hr	Mon 8/8/16	Mon 8/8/16
1676	Training	1 day	Mon 8/8/16	Tue 8/9/16
1677	Onsite Customer ITS/WAP Instructor Led Training	1 day	Mon 8/8/16	Tue 8/9/16
1678	Complete and distribute Training Review forms	1 day	Mon 8/8/16	Tue 8/9/16
1679	Customer Acceptance for NY DOC Correctional Facility	1 day	Mon 8/8/16	Tue 8/9/16
1680	BARE HILL CORRECTIONAL FACILITY	3.75 days	Thu 8/11/16	Tue 8/16/16
1681	Transport Test & Turn-up Activities with Telecom Provider	1 day	Thu 8/11/16	Thu 8/11/16
1682	Transport turned up with Telecom Provider	1 day	Thu 8/11/16	Thu 8/11/16
1683	Circuit connected to Securus equipment	1 day	Thu 8/11/16	Thu 8/11/16
1684	Installation Support confirmation that Securus equipment on-line	1 day	Thu 8/11/16	Thu 8/11/16
1685	Cut-Over to Securus	2.31 days	Thu 8/11/16	Mon 8/15/16
1686	Re-Verify all Features working properly	0.5 hrs	Thu 8/11/16	Thu 8/11/16
1687	Re-Verify phones work, port assignments/call groups set	0.5 hrs	Thu 8/11/16	Thu 8/11/16
1688	Post Cutover QA Checklist & Test Calls Completed	0.5 hrs	Thu 8/11/16	Thu 8/11/16
1689	Notify Facility ITS/WAP is prepared for cutover and functioning correctly	0.5 hrs	Thu 8/11/16	Thu 8/11/16
1690	Cut Sheet distributed to Securus Project Team	0.5 hrs	Thu 8/11/16	Thu 8/11/16
1691	Complete and certify integration with OMS & Commissary Vendor	1 day	Thu 8/11/16	Fri 8/12/16
1692	Cut-over activities by Dorm/Offender Housing Locations	2 days	Thu 8/11/16	Mon 8/15/16
1693	Quality Control Checkpoint: Customer Acceptance	1.44 days	Mon 8/15/16	Tue 8/16/16
1694	Customer walk through at facility	0.5 hrs	Mon 8/15/16	Mon 8/15/16
1695	Customer review of Quality Control documentation	0.5 hrs	Mon 8/15/16	Mon 8/15/16
1696	Post Cut-over Activities	1.38 days	Mon 8/15/16	Tue 8/16/16

ID	Task Name	Duration	Start	Finish
1697	Final installation diagrams (datacom, electrical, and equipment diagrams)	1 hr	Mon 8/15/16	Mon 8/15/16
1698	Site Cutover Preparation Complete - Ready for Training	1 hr	Mon 8/15/16	Mon 8/15/16
1699	Distribute Implementation Customer Satisfaction Survey	1 hr	Mon 8/15/16	Mon 8/15/16
1700	Training	1 day	Mon 8/15/16	Tue 8/16/16
1701	Onsite Customer ITS/AWAP Instructor Led Training	1 day	Mon 8/15/16	Tue 8/16/16
1702	Complete and distribute Training Review forms	1 day	Mon 8/15/16	Tue 8/16/16
1703	Customer Acceptance for NY DOC Correctional Facility	1 day	Mon 8/15/16	Tue 8/16/16
1704	UPSTATE CORRECTIONAL FACILITY	3.75 days	Thu 8/11/16	Tue 8/16/16
1705	Transport Test & Turn-up Activities with Telecom Provider	1 day	Thu 8/11/16	Thu 8/11/16
1706	Transport turned up with Telecom Provider	1 day	Thu 8/11/16	Thu 8/11/16
1707	Circuit connected to Securus equipment	1 day	Thu 8/11/16	Thu 8/11/16
1708	Installation Support confirmation that Securus equipment on-line	1 day	Thu 8/11/16	Thu 8/11/16
1709	Cut-Over to Securus	2.31 days	Thu 8/11/16	Mon 8/15/16
1710	Re-Verify all Features working properly	0.5 hrs	Thu 8/11/16	Thu 8/11/16
1711	Re-Verify phones work, port assignments/call groups set	0.5 hrs	Thu 8/11/16	Thu 8/11/16
1712	Post Cutover QA Checklist & Test Calls Completed	0.5 hrs	Thu 8/11/16	Thu 8/11/16
1713	Notify Facility ITS/AWAP is prepared for cutover and functioning correctly	0.5 hrs	Thu 8/11/16	Thu 8/11/16
1714	Cut Sheet distributed to Securus Project Team	0.5 hrs	Thu 8/11/16	Thu 8/11/16
1715	Complete and certify integration with OMS & Commissary Vendor	1 day	Thu 8/11/16	Fri 8/12/16
1716	Cut-over activities by Dorm/Offender Housing Locations	2 days	Thu 8/11/16	Mon 8/15/16
1717	Quality Control Checkpoint: Customer Acceptance	1.44 days	Mon 8/15/16	Tue 8/16/16
1718	Customer walk through at facility	0.5 hrs	Mon 8/15/16	Mon 8/15/16
1719	Customer review of Quality Control documentation	0.5 hrs	Mon 8/15/16	Mon 8/15/16
1720	Post Cut-over Activities	1.38 days	Mon 8/15/16	Tue 8/16/16
1721	Final installation diagrams (datacom, electrical, and equipment diagrams)	1 hr	Mon 8/15/16	Mon 8/15/16
1722	Site Cutover Preparation Complete - Ready for Training	1 hr	Mon 8/15/16	Mon 8/15/16
1723	Distribute Implementation Customer Satisfaction Survey	1 hr	Mon 8/15/16	Mon 8/15/16
1724	Training	1 day	Mon 8/15/16	Tue 8/16/16
1725	Onsite Customer ITS/AWAP Instructor Led Training	1 day	Mon 8/15/16	Tue 8/16/16
1726	Complete and distribute Training Review forms	1 day	Mon 8/15/16	Tue 8/16/16
1727	Customer Acceptance for NY DOC Correctional Facility	1 day	Mon 8/15/16	Tue 8/16/16
1728	CHATEAUGAY CORRECTIONAL FACILITY	3.75 days	Thu 8/11/16	Tue 8/16/16
1729	Transport Test & Turn-up Activities with Telecom Provider	1 day	Thu 8/11/16	Thu 8/11/16
1730	Transport turned up with Telecom Provider	1 day	Thu 8/11/16	Thu 8/11/16
1731	Circuit connected to Securus equipment	1 day	Thu 8/11/16	Thu 8/11/16
1732	Installation Support confirmation that Securus equipment on-line	1 day	Thu 8/11/16	Thu 8/11/16
1733	Cut-Over to Securus	2.31 days	Thu 8/11/16	Mon 8/15/16

ID	Task Name	Duration	Start	Finish
1734	Re-Verify all Features working properly	0.5 hrs	Thu 8/11/16	Thu 8/11/16
1735	Re-Verify phones work, port assignments/call groups set	0.5 hrs	Thu 8/11/16	Thu 8/11/16
1736	Post Cutover QA Checklist & Test Calls Completed	0.5 hrs	Thu 8/11/16	Thu 8/11/16
1737	Notify Facility ITS/WAP is prepared for cutover and functioning correctly	0.5 hrs	Thu 8/11/16	Thu 8/11/16
1738	Cut Sheet distributed to Securus Project Team	0.5 hrs	Thu 8/11/16	Thu 8/11/16
1739	Complete and certify integration with OMS & Commissary Vendor	1 day	Thu 8/11/16	Fri 8/12/16
1740	Cut-over activities by Dorm/Offender Housing Locations	2 days	Thu 8/11/16	Mon 8/15/16
1741	Quality Control Checkpoint: Customer Acceptance	1.44 days	Mon 8/15/16	Tue 8/16/16
1742	Customer walk through at facility	0.5 hrs	Mon 8/15/16	Mon 8/15/16
1743	Customer review of Quality Control documentation	0.5 hrs	Mon 8/15/16	Mon 8/15/16
1744	Post Cut-over Activities	1.38 days	Mon 8/15/16	Tue 8/16/16
1745	Final installation diagrams (datacom, electrical, and equipment diagrams)	1 hr	Mon 8/15/16	Mon 8/15/16
1746	Site Cutover Preparation Complete - Ready for Training	1 hr	Mon 8/15/16	Mon 8/15/16
1747	Distribute Implementation Customer Satisfaction Survey	1 hr	Mon 8/15/16	Mon 8/15/16
1748	Training	1 day	Mon 8/15/16	Tue 8/16/16
1749	Onsite Customer ITS/WAP Instructor Led Training	1 day	Mon 8/15/16	Tue 8/16/16
1750	Complete and distribute Training Review forms	1 day	Mon 8/15/16	Tue 8/16/16
1751	Customer Acceptance for NY DOC Correctional Facility	1 day	Mon 8/15/16	Tue 8/16/16
1752	ALTONA CORRECTIONAL FACILITY	3.75 days	Thu 8/18/16	Wed 8/24/16
1753	Transport Test & Turn-up Activities with Telecom Provider	1 day	Thu 8/18/16	Fri 8/19/16
1754	Transport turned up with Telecom Provider	1 day	Thu 8/18/16	Fri 8/19/16
1755	Circuit connected to Securus equipment	1 day	Thu 8/18/16	Fri 8/19/16
1756	Installation Support confirmation that Securus equipment on-line	1 day	Thu 8/18/16	Fri 8/19/16
1757	Cut-Over to Securus	2.31 days	Thu 8/18/16	Mon 8/22/16
1758	Re-Verify all Features working properly	0.5 hrs	Thu 8/18/16	Thu 8/18/16
1759	Re-Verify phones work, port assignments/call groups set	0.5 hrs	Thu 8/18/16	Thu 8/18/16
1760	Post Cutover QA Checklist & Test Calls Completed	0.5 hrs	Thu 8/18/16	Thu 8/18/16
1761	Notify Facility ITS/WAP is prepared for cutover and functioning correctly	0.5 hrs	Thu 8/18/16	Thu 8/18/16
1762	Cut Sheet distributed to Securus Project Team	0.5 hrs	Thu 8/18/16	Thu 8/18/16
1763	Complete and certify integration with OMS & Commissary Vendor	1 day	Thu 8/18/16	Fri 8/19/16
1764	Cut-over activities by Dorm/Offender Housing Locations	2 days	Thu 8/18/16	Mon 8/22/16
1765	Quality Control Checkpoint: Customer Acceptance	1.44 days	Mon 8/22/16	Wed 8/24/16
1766	Customer walk through at facility	0.5 hrs	Mon 8/22/16	Mon 8/22/16
1767	Customer review of Quality Control documentation	0.5 hrs	Mon 8/22/16	Mon 8/22/16
1768	Post Cut-over Activities	1.38 days	Mon 8/22/16	Wed 8/24/16
1769	Final installation diagrams (datacom, electrical, and equipment diagrams)	1 hr	Mon 8/22/16	Mon 8/22/16
1770	Site Cutover Preparation Complete - Ready for Training	1 hr	Mon 8/22/16	Mon 8/22/16

ID	Task Name	Duration	Start	Finish
1771	Distribute Implementation Customer Satisfaction Survey	1 hr	Tue 8/23/16	Tue 8/23/16
1772	Training	1 day	Tue 8/23/16	Wed 8/24/16
1773	Onsite Customer ITS/WAP Instructor Led Training	1 day	Tue 8/23/16	Wed 8/24/16
1774	Complete and distribute Training Review forms	1 day	Tue 8/23/16	Wed 8/24/16
1775	Customer Acceptance for NY DOC Correctional Facility	1 day	Tue 8/23/16	Wed 8/24/16
1776	CLINTON CORRECTIONAL FACILITY	3.75 days	Thu 8/18/16	Wed 8/24/16
1777	Transport Test & Turn-up Activities with Telecom Provider	1 day	Thu 8/18/16	Fri 8/19/16
1778	Transport turned up with Telecom Provider	1 day	Thu 8/18/16	Fri 8/19/16
1779	Circuit connected to Securus equipment	1 day	Thu 8/18/16	Fri 8/19/16
1780	Installation Support confirmation that Securus equipment on-line	1 day	Thu 8/18/16	Fri 8/19/16
1781	Cut-Over to Securus	2.31 days	Thu 8/18/16	Mon 8/22/16
1782	Re-Verify all Features working properly	0.5 hrs	Thu 8/18/16	Thu 8/18/16
1783	Re-Verify phones work, port assignments/call groups set	0.5 hrs	Thu 8/18/16	Thu 8/18/16
1784	Post Cutover QA Checklist & Test Calls Completed	0.5 hrs	Thu 8/18/16	Thu 8/18/16
1785	Notify Facility ITS/WAP is prepared for cutover and functioning correctly	0.5 hrs	Thu 8/18/16	Thu 8/18/16
1786	Cut Sheet distributed to Securus Project Team	0.5 hrs	Thu 8/18/16	Thu 8/18/16
1787	Complete and certify integration with OMS & Commissary Vendor	1 day	Thu 8/18/16	Fri 8/19/16
1788	Cut-over activities by Dorm/Offender Housing Locations	2 days	Thu 8/18/16	Mon 8/22/16
1789	Quality Control Checkpoint: Customer Acceptance	1.44 days	Mon 8/22/16	Wed 8/24/16
1790	Customer walk through at facility	0.5 hrs	Mon 8/22/16	Mon 8/22/16
1791	Customer review of Quality Control documentation	0.5 hrs	Mon 8/22/16	Mon 8/22/16
1792	Post Cut-over Activities	1.38 days	Mon 8/22/16	Wed 8/24/16
1793	Final installation diagrams (datacom, electrical, and equipment diagrams)	1 hr	Mon 8/22/16	Mon 8/22/16
1794	Site Cutover Preparation Complete - Ready for Training	1 hr	Mon 8/22/16	Mon 8/22/16
1795	Distribute Implementation Customer Satisfaction Survey	1 hr	Tue 8/23/16	Tue 8/23/16
1796	Training	1 day	Tue 8/23/16	Wed 8/24/16
1797	Onsite Customer ITS/WAP Instructor Led Training	1 day	Tue 8/23/16	Wed 8/24/16
1798	Complete and distribute Training Review forms	1 day	Tue 8/23/16	Wed 8/24/16
1799	Customer Acceptance for NY DOC Correctional Facility	1 day	Tue 8/23/16	Wed 8/24/16
1800	ADIRONDACK CORRECTIONAL FACILITY	3.75 days	Thu 8/18/16	Wed 8/24/16
1801	Transport Test & Turn-up Activities with Telecom Provider	1 day	Thu 8/18/16	Fri 8/19/16
1802	Transport turned up with Telecom Provider	1 day	Thu 8/18/16	Fri 8/19/16
1803	Circuit connected to Securus equipment	1 day	Thu 8/18/16	Fri 8/19/16
1804	Installation Support confirmation that Securus equipment on-line	1 day	Thu 8/18/16	Fri 8/19/16
1805	Cut-Over to Securus	2.31 days	Thu 8/18/16	Mon 8/22/16
1806	Re-Verify all Features working properly	0.5 hrs	Thu 8/18/16	Thu 8/18/16
1807	Re-Verify phones work, port assignments/call groups set	0.5 hrs	Thu 8/18/16	Thu 8/18/16

ID	Task Name	Duration	Start	Finish
1808	Post Cutover QA Checklist & Test Calls Completed	0.5 hrs	Thu 8/18/16	Thu 8/18/16
1809	Notify Facility ITS/WAP is prepared for cutover and functioning correctly	0.5 hrs	Thu 8/18/16	Thu 8/18/16
1810	Cut Sheet distributed to Securus Project Team	0.5 hrs	Thu 8/18/16	Thu 8/18/16
1811	Complete and certify integration with OMS & Commissary Vendor	1 day	Thu 8/18/16	Fri 8/19/16
1812	Cut-over activities by Dorm/Offender Housing Locations	2 days	Thu 8/18/16	Mon 8/22/16
1813	Quality Control Checkpoint: Customer Acceptance	1.44 days	Mon 8/22/16	Wed 8/24/16
1814	Customer walk through at facility	0.5 hrs	Mon 8/22/16	Mon 8/22/16
1815	Customer review of Quality Control documentation	0.5 hrs	Mon 8/22/16	Mon 8/22/16
1816	Post Cut-over Activities	1.38 days	Mon 8/22/16	Wed 8/24/16
1817	Final installation diagrams (datacom, electrical, and equipment diagrams)	1 hr	Mon 8/22/16	Mon 8/22/16
1818	Site Cutover Preparation Complete - Ready for Training	1 hr	Mon 8/22/16	Mon 8/22/16
1819	Distribute Implementation Customer Satisfaction Survey	1 hr	Tue 8/23/16	Tue 8/23/16
1820	Training	1 day	Tue 8/23/16	Wed 8/24/16
1821	Onsite Customer ITS/WAP Instructor Led Training			
1822	Complete and distribute Training Review forms	1 day	Tue 8/23/16	Wed 8/24/16
1823	Customer Acceptance for NY DOC Correctional Facility	1 day	Tue 8/23/16	Wed 8/24/16
1824	MORIAH SHOCK INCARCERATION CORRECTIONAL FACILITY	3.75 days	Tue 8/23/16	Wed 8/24/16
1825	Transport Test & Turn-up Activities with Telecom Provider	1 day	Thu 8/25/16	Wed 8/31/16
1826	Transport turned up with Telecom Provider	1 day	Thu 8/25/16	Fri 8/26/16
1827	Circuit connected to Securus equipment	1 day	Thu 8/25/16	Fri 8/26/16
1828	Installation Support confirmation that Securus equipment on-line	1 day	Thu 8/25/16	Fri 8/26/16
1829	Cut-Over to Securus	2.31 days	Thu 8/25/16	Tue 8/30/16
1830	Re-Verify all Features working properly	0.5 hrs	Thu 8/25/16	Thu 8/25/16
1831	Re-Verify phones work, port assignments/call groups set	0.5 hrs	Thu 8/25/16	Thu 8/25/16
1832	Post Cutover QA Checklist & Test Calls Completed	0.5 hrs	Thu 8/25/16	Thu 8/25/16
1833	Notify Facility ITS/WAP is prepared for cutover and functioning correctly	0.5 hrs	Thu 8/25/16	Thu 8/25/16
1834	Cut Sheet distributed to Securus Project Team	0.5 hrs	Fri 8/26/16	Fri 8/26/16
1835	Complete and certify integration with OMS & Commissary Vendor	1 day	Fri 8/26/16	Mon 8/29/16
1836	Cut-over activities by Dorm/Offender Housing Locations	2 days	Fri 8/26/16	Tue 8/30/16
1837	Quality Control Checkpoint: Customer Acceptance	1.44 days	Tue 8/30/16	Wed 8/31/16
1838	Customer walk through at facility	0.5 hrs	Tue 8/30/16	Tue 8/30/16
1839	Customer review of Quality Control documentation	0.5 hrs	Tue 8/30/16	Tue 8/30/16
1840	Post Cut-over Activities	1.38 days	Tue 8/30/16	Wed 8/31/16
1841	Final installation diagrams (datacom, electrical, and equipment diagrams)	1 hr	Tue 8/30/16	Tue 8/30/16
1842	Site Cutover Preparation Complete - Ready for Training	1 hr	Tue 8/30/16	Tue 8/30/16
1843	Distribute Implementation Customer Satisfaction Survey	1 hr	Tue 8/30/16	Tue 8/30/16
1844	Training	1 day	Tue 8/30/16	Wed 8/31/16

ID	Task Name	Duration	Start	Finish
1845	Onsite Customer ITS/WAP Instructor Led Training	1 day	Tue 8/30/16	Wed 8/31/16
1846	Complete and distribute Training Review forms	1 day	Tue 8/30/16	Wed 8/31/16
1847	Customer Acceptance for NY DOC Correctional Facility	1 day	Tue 8/30/16	Wed 8/31/16
1848	WASHINGTON CORRECTIONAL FACILITY	3.75 days	Thu 8/25/16	Wed 8/31/16
1849	Transport Test & Turn-up Activities with Telecom Provider	1 day	Thu 8/25/16	Fri 8/26/16
1850	Transport turned up with Telecom Provider	1 day	Thu 8/25/16	Fri 8/26/16
1851	Circuit connected to Securus equipment	1 day	Thu 8/25/16	Fri 8/26/16
1852	Installation Support confirmation that Securus equipment on-line	1 day	Thu 8/25/16	Fri 8/26/16
1853	Cut-Over to Securus	2.31 days	Thu 8/25/16	Tue 8/30/16
1854	Re-Verify all Features working properly	0.5 hrs	Thu 8/25/16	Thu 8/25/16
1855	Re-Verify phones work, port assignments/call groups set	0.5 hrs	Thu 8/25/16	Thu 8/25/16
1856	Post Cutover QA Checklist & Test Calls Completed	0.5 hrs	Thu 8/25/16	Thu 8/25/16
1857	Notify Facility ITS/WAP is prepared for cutover and functioning correctly	0.5 hrs	Thu 8/25/16	Thu 8/25/16
1858	Cut Sheet distributed to Securus Project Team	0.5 hrs	Fri 8/26/16	Fri 8/26/16
1859	Complete and certify integration with OMS & Commissary Vendor	1 day	Fri 8/26/16	Mon 8/29/16
1860	Cut-over activities by Dorm/Offender Housing Locations	2 days	Fri 8/26/16	Tue 8/30/16
1861	Quality Control Checkpoint: Customer Acceptance	1.44 days	Tue 8/30/16	Wed 8/31/16
1862	Customer walk through at facility	0.5 hrs	Tue 8/30/16	Tue 8/30/16
1863	Customer review of Quality Control documentation	0.5 hrs	Tue 8/30/16	Tue 8/30/16
1864	Post Cut-over Activities	1.38 days	Tue 8/30/16	Wed 8/31/16
1865	Final installation diagrams (datacom, electrical, and equipment diagrams)	1 hr	Tue 8/30/16	Tue 8/30/16
1866	Site Cutover Preparation Complete - Ready for Training	1 hr	Tue 8/30/16	Tue 8/30/16
1867	Distribute Implementation Customer Satisfaction Survey	1 hr	Tue 8/30/16	Tue 8/30/16
1868	Training	1 day	Tue 8/30/16	Wed 8/31/16
1869	Onsite Customer ITS/WAP Instructor Led Training	1 day	Tue 8/30/16	Wed 8/31/16
1870	Complete and distribute Training Review forms	1 day	Tue 8/30/16	Wed 8/31/16
1871	Customer Acceptance for NY DOC Correctional Facility	1 day	Tue 8/30/16	Wed 8/31/16
1872	GREAT MEADOW CORRECTIONAL FACILITY	3.75 days	Thu 8/25/16	Wed 8/31/16
1873	Transport Test & Turn-up Activities with Telecom Provider	1 day	Thu 8/25/16	Fri 8/26/16
1874	Transport turned up with Telecom Provider	1 day	Thu 8/25/16	Fri 8/26/16
1875	Circuit connected to Securus equipment	1 day	Thu 8/25/16	Fri 8/26/16
1876	Installation Support confirmation that Securus equipment on-line	1 day	Thu 8/25/16	Fri 8/26/16
1877	Cut-Over to Securus	2.31 days	Thu 8/25/16	Tue 8/30/16
1878	Re-Verify all Features working properly	0.5 hrs	Thu 8/25/16	Thu 8/25/16
1879	Re-Verify phones work, port assignments/call groups set	0.5 hrs	Thu 8/25/16	Thu 8/25/16
1880	Post Cutover QA Checklist & Test Calls Completed	0.5 hrs	Thu 8/25/16	Thu 8/25/16
1881	Notify Facility ITS/WAP is prepared for cutover and functioning correctly	0.5 hrs	Thu 8/25/16	Thu 8/25/16

ID	Task Name	Duration	Start	Finish
1882	Cut Sheet distributed to Securus Project Team	0.5 hrs	Fri 8/26/16	Fri 8/26/16
1883	Complete and certify integration with OMS & Commissary Vendor	1 day	Fri 8/26/16	Mon 8/29/16
1884	Cut-over activities by Dorm/Offender Housing Locations	2 days	Fri 8/26/16	Tue 8/30/16
1885	Quality Control Checkpoint: Customer Acceptance	1.44 days	Tue 8/30/16	Wed 8/31/16
1886	Customer walk through at facility	0.5 hrs	Tue 8/30/16	Tue 8/30/16
1887	Customer review of Quality Control documentation	0.5 hrs	Tue 8/30/16	Tue 8/30/16
1888	Post Cut-over Activities	1.38 days	Tue 8/30/16	Wed 8/31/16
1889	Final installation diagrams (datacom, electrical, and equipment diagrams)	1 hr	Tue 8/30/16	Tue 8/30/16
1890	Site Cutover Preparation Complete - Ready for Training	1 hr	Tue 8/30/16	Tue 8/30/16
1891	Distribute Implementation Customer Satisfaction Survey	1 hr	Tue 8/30/16	Tue 8/30/16
1892	Training	1 day	Tue 8/30/16	Wed 8/31/16
1893	Onsite Customer ITS/WAP Instructor Led Training	1 day	Tue 8/30/16	Wed 8/31/16
1894	Complete and distribute Training Review forms	1 day	Tue 8/30/16	Wed 8/31/16
1895	Customer Acceptance for NY DOC Correctional Facility	1 day	Tue 8/30/16	Wed 8/31/16
1896	Installation Region 2 Facilities	25.25 days	Wed 7/27/16	Wed 8/31/16
1897	WOODBOURNE CORRECTIONAL FACILITY	3.75 days	Wed 7/27/16	Mon 8/1/16
1898	Transport Test & Turn-up Activities with Telecom Provider	1 day	Wed 7/27/16	Thu 7/28/16
1899	Transport tur ned up with Telecom Provider	1 day	Wed 7/27/16	Thu 7/28/16
1900	Circuit connected to Securus equipment	1 day	Wed 7/27/16	Thu 7/28/16
1901	Installation Support confirmation that Securus equipment on-line	1 day	Wed 7/27/16	Thu 7/28/16
1902	Cut-Over to Securus	2.31 days	Wed 7/27/16	Fri 7/29/16
1903	Re-Verify all Features working properly	0.5 hrs	Wed 7/27/16	Wed 7/27/16
1904	Re-Verify phones work, port assignments/call groups set	0.5 hrs	Wed 7/27/16	Wed 7/27/16
1905	Post Cutover QA Checklist & Test Calls Completed	0.5 hrs	Wed 7/27/16	Wed 7/27/16
1906	Notify Facility ITS/WAP is prepared for cutover and functioning correctly	0.5 hrs	Wed 7/27/16	Wed 7/27/16
1907	Cut Sheet distributed to Securus Project Team	0.5 hrs	Wed 7/27/16	Wed 7/27/16
1908	Complete and certify integration with OMS & Commissary Vendor	1 day	Wed 7/27/16	Thu 7/28/16
1909	Cut-over activities by Dorm/Offender Housing Locations	2 days	Wed 7/27/16	Fri 7/29/16
1910	Quality Control Checkpoint: Customer Acceptance	1.44 days	Fri 7/29/16	Mon 8/1/16
1911	Customer walk through at facility	0.5 hrs	Fri 7/29/16	Fri 7/29/16
1912	Customer review of Quality Control documentation	0.5 hrs	Fri 7/29/16	Fri 7/29/16
1913	Post Cut-over Activities	1.38 days	Fri 7/29/16	Mon 8/1/16
1914	Final installation diagrams (datacom, electrical, and equipment diagrams)	1 hr	Fri 7/29/16	Fri 7/29/16
1915	Site Cutover Preparation Complete - Ready for Training	1 hr	Fri 7/29/16	Fri 7/29/16
1916	Distribute Implementation Customer Satisfaction Survey	1 hr	Fri 7/29/16	Fri 7/29/16
1917	Training	1 day	Mon 8/1/16	Mon 8/1/16
1918	Onsite Customer ITS/WAP Instructor Led Training	1 day	Mon 8/1/16	Mon 8/1/16

ID	Task Name	Duration	Start	Finish
1919	Complete and distribute Training Review forms	1 day	Mon 8/1/16	Mon 8/1/16
1920	Customer Acceptance for NY DOC Correctional Facility	1 day	Mon 8/1/16	Mon 8/1/16
1921	SULLIVAN CORRECTIONAL FACILITY	3.75 days	Wed 7/27/16	Mon 8/1/16
1922	Transport Test & Turn-up Activities with Telecom Provider	1 day	Wed 7/27/16	Thu 7/28/16
1923	Transport turned up with Telecom Provider	1 day	Wed 7/27/16	Thu 7/28/16
1924	Circuit connected to Securus equipment	1 day	Wed 7/27/16	Thu 7/28/16
1925	Installation Support confirmation that Securus equipment on-line	1 day	Wed 7/27/16	Thu 7/28/16
1926	Cut-Over to Securus	2.31 days	Wed 7/27/16	Fri 7/29/16
1927	Re-Verify all Features working properly	0.5 hrs	Wed 7/27/16	Wed 7/27/16
1928	Re-Verify phones work, port assignments/call groups set	0.5 hrs	Wed 7/27/16	Wed 7/27/16
1929	Post Cutover QA Checklist & Test Calls Completed	0.5 hrs	Wed 7/27/16	Wed 7/27/16
1930	Notify Facility ITS/WAP is prepared for cutover and functioning correctly	0.5 hrs	Wed 7/27/16	Wed 7/27/16
1931	Cut Sheet distributed to Securus Project Team	0.5 hrs	Wed 7/27/16	Wed 7/27/16
1932	Complete and certify integration with OMS & Commissary Vendor	1 day	Wed 7/27/16	Thu 7/28/16
1933	Cut-over activities by Dorm/Offender Housing Locations	2 days	Wed 7/27/16	Fri 7/29/16
1934	Quality Control Checkpoint: Customer Acceptance	1.44 days	Fri 7/29/16	Mon 8/1/16
1935	Customer walk through at facility	0.5 hrs	Fri 7/29/16	Fri 7/29/16
1936	Customer review of Quality Control documentation	0.5 hrs	Fri 7/29/16	Fri 7/29/16
1937	Post Cut-over Activities	1.38 days	Fri 7/29/16	Mon 8/1/16
1938	Final installation diagrams (datacom, electrical, and equipment diagrams)	1 hr	Fri 7/29/16	Fri 7/29/16
1939	Site Cutover Preparation Complete - Ready for Training	1 hr	Fri 7/29/16	Fri 7/29/16
1940	Distribute Implementation Customer Satisfaction Survey	1 hr	Fri 7/29/16	Fri 7/29/16
1941	Training	1 day	Mon 8/1/16	Mon 8/1/16
1942	Onsite Customer ITS/WAP Instructor Led Training	1 day	Mon 8/1/16	Mon 8/1/16
1943	Complete and distribute Training Review forms	1 day	Mon 8/1/16	Mon 8/1/16
1944	Customer Acceptance for NY DOC Correctional Facility	1 day	Mon 8/1/16	Mon 8/1/16
1945	EASTERN NEW YORK CORRECTIONAL FACILITY	3.75 days	Wed 7/27/16	Mon 8/1/16
1946	Transport Test & Turn-up Activities with Telecom Provider	1 day	Wed 7/27/16	Thu 7/28/16
1947	Transport turned up with Telecom Provider	1 day	Wed 7/27/16	Thu 7/28/16
1948	Circuit connected to Securus equipment	1 day	Wed 7/27/16	Thu 7/28/16
1949	Installation Support confirmation that Securus equipment on-line	1 day	Wed 7/27/16	Thu 7/28/16
1950	Cut-Over to Securus	2.31 days	Wed 7/27/16	Fri 7/29/16
1951	Re-Verify all Features working properly	0.5 hrs	Wed 7/27/16	Wed 7/27/16
1952	Re-Verify phones work, port assignments/call groups set	0.5 hrs	Wed 7/27/16	Wed 7/27/16
1953	Post Cutover QA Checklist & Test Calls Completed	0.5 hrs	Wed 7/27/16	Wed 7/27/16
1954	Notify Facility ITS/WAP is prepared for cutover and functioning correctly	0.5 hrs	Wed 7/27/16	Wed 7/27/16
1955	Cut Sheet distributed to Securus Project Team	0.5 hrs	Wed 7/27/16	Wed 7/27/16

ID	Task Name	Duration	Start	Finish
1956	Complete and certify integration with OMS & Commissary Vendor	1 day	Wed 7/27/16	Thu 7/28/16
1957	Cutover activities by Dorm/Offender Housing Locations	2 days	Wed 7/27/16	Fri 7/29/16
1958	Quality Control Checkpoint: Customer Acceptance	1.44 days	Fri 7/29/16	Mon 8/1/16
1959	Customer walk through at facility	0.5 hrs	Fri 7/29/16	Fri 7/29/16
1960	Customer review of Quality Control documentation	0.5 hrs	Fri 7/29/16	Fri 7/29/16
1961	Post Cut-over Activities	1.38 days	Fri 7/29/16	Mon 8/1/16
1962	Final installation diagrams (datacom, electrical, and equipment diagrams)	1 hr	Fri 7/29/16	Fri 7/29/16
1963	Site Cutover Preparation Complete - Ready for Training	1 hr	Fri 7/29/16	Fri 7/29/16
1964	Distribute Implementation Customer Satisfaction Survey	1 hr	Fri 7/29/16	Fri 7/29/16
1965	Training	1 day	Mon 8/1/16	Mon 8/1/16
1966	Onsite Customer ITS/WAP Instructor Led Training	1 day	Mon 8/1/16	Mon 8/1/16
1967	Complete and distribute Training Review forms	1 day	Mon 8/1/16	Mon 8/1/16
1968	Customer Acceptance for NY DOC Correctional Facility	1 day	Mon 8/1/16	Mon 8/1/16
1969	ULSTER CORRECTIONAL FACILITY	3.75 days	Wed 8/3/16	Tue 8/9/16
1970	Transport Test & Turn-up Activities with Telecom Provider	1 day	Wed 8/3/16	Thu 8/4/16
1971	Transport turned up with Telecom Provider	1 day	Wed 8/3/16	Thu 8/4/16
1972	Circuit connected to Securus equipment	1 day	Wed 8/3/16	Thu 8/4/16
1973	Installation Support confirmation that Securus equipment on-line	1 day	Wed 8/3/16	Thu 8/4/16
1974	Cut-Over to Securus	2.31 days	Wed 8/3/16	Fri 8/5/16
1975	Re-Verify all Features working properly	0.5 hrs	Wed 8/3/16	Wed 8/3/16
1976	Re-Verify phones work, port assignments/call groups set	0.5 hrs	Wed 8/3/16	Wed 8/3/16
1977	Post Cutover QA Checklist & Test Calls Completed	0.5 hrs	Wed 8/3/16	Wed 8/3/16
1978	Notify Facility ITS/WAP is prepared for cutover and functioning correctly	0.5 hrs	Wed 8/3/16	Wed 8/3/16
1979	Cut Sheet distributed to Securus Project Team	0.5 hrs	Wed 8/3/16	Wed 8/3/16
1980	Complete and certify integration with OMS & Commissary Vendor	1 day	Wed 8/3/16	Thu 8/4/16
1981	Cutover activities by Dorm/Offender Housing Locations	2 days	Wed 8/3/16	Fri 8/5/16
1982	Quality Control Checkpoint: Customer Acceptance	1.44 days	Fri 8/5/16	Tue 8/9/16
1983	Customer walk through at facility	0.5 hrs	Fri 8/5/16	Fri 8/5/16
1984	Customer review of Quality Control documentation	0.5 hrs	Fri 8/5/16	Fri 8/5/16
1985	Post Cut-over Activities	1.38 days	Mon 8/8/16	Tue 8/9/16
1986	Final installation diagrams (datacom, electrical, and equipment diagrams)	1 hr	Mon 8/8/16	Mon 8/8/16
1987	Site Cutover Preparation Complete - Ready for Training	1 hr	Mon 8/8/16	Mon 8/8/16
1988	Distribute Implementation Customer Satisfaction Survey	1 hr	Mon 8/8/16	Mon 8/8/16
1989	Training	1 day	Mon 8/8/16	Tue 8/9/16
1990	Onsite Customer ITS/WAP Instructor Led Training	1 day	Mon 8/8/16	Tue 8/9/16
1991	Complete and distribute Training Review forms	1 day	Mon 8/8/16	Tue 8/9/16
1992	Customer Acceptance for NY DOC Correctional Facility	1 day	Mon 8/8/16	Tue 8/9/16

ID	Task Name	Duration	Start	Finish
1993	HUDSON CORRECTIONAL FACILITY	3.75 days	Wed 8/3/16	Tue 8/9/16
1994	Transport Test & Turn-up Activities with Telecom Provider	1 day	Wed 8/3/16	Thu 8/4/16
1995	Transport turned up with Telecom Provider	1 day	Wed 8/3/16	Thu 8/4/16
1996	Circuit connected to Securus equipment	1 day	Wed 8/3/16	Thu 8/4/16
1997	Installation Support confirmation that Securus equipment on-line	1 day	Wed 8/3/16	Thu 8/4/16
1998	Cut-Over to Securus	2.31 days	Wed 8/3/16	Fri 8/5/16
1999	Re-Verify all Features working properly	0.5 hrs	Wed 8/3/16	Wed 8/3/16
2000	Re-Verify phones work, port assignments/call groups set	0.5 hrs	Wed 8/3/16	Wed 8/3/16
2001	Post Cutover QA Checklist & Test Calls Completed	0.5 hrs	Wed 8/3/16	Wed 8/3/16
2002	Notify Facility ITS/WAP is prepared for cutover and functioning correctly	0.5 hrs	Wed 8/3/16	Wed 8/3/16
2003	Cut Sheet distributed to Securus Project Team	0.5 hrs	Wed 8/3/16	Wed 8/3/16
2004	Complete and certify integration with OMS & Commissary Vendor	1 day	Wed 8/3/16	Thu 8/4/16
2005	Cut-over activities by Dorm/Offender Housing Locations	2 days	Wed 8/3/16	Fri 8/5/16
2006	Quality Control Checkpoint: Customer Acceptance	1.44 days	Fri 8/5/16	Tue 8/9/16
2007	Customer walk through at facility	0.5 hrs	Fri 8/5/16	Fri 8/5/16
2008	Customer review of Quality Control documentation	0.5 hrs	Fri 8/5/16	Fri 8/5/16
2009	Post Cut-over Activities	1.38 days	Mon 8/8/16	Tue 8/9/16
2010	Final installation diagrams (datacom, electrical, and equipment diagrams)	1 hr	Mon 8/8/16	Mon 8/8/16
2011	Site Cutover Preparation Complete - Ready for Training	1 hr	Mon 8/8/16	Mon 8/8/16
2012	Distribute Implementation Customer Satisfaction Survey	1 hr	Mon 8/8/16	Mon 8/8/16
2013	Training	1 day	Mon 8/8/16	Tue 8/9/16
2014	Onsite Customer ITS/WAP Instructor Led Training	1 day	Mon 8/8/16	Tue 8/9/16
2015	Complete and distribute Training Review forms	1 day	Mon 8/8/16	Tue 8/9/16
2016	Customer Acceptance for NY DOC Correctional Facility	1 day	Mon 8/8/16	Tue 8/9/16
2017	COXSACKIE CORRECTIONAL FACILITY	3.75 days	Wed 8/3/16	Tue 8/9/16
2018	Transport Test & Turn-up Activities with Telecom Provider	1 day	Wed 8/3/16	Thu 8/4/16
2019	Transport turned up with Telecom Provider	1 day	Wed 8/3/16	Thu 8/4/16
2020	Circuit connected to Securus equipment	1 day	Wed 8/3/16	Thu 8/4/16
2021	Installation Support confirmation that Securus equipment on-line	1 day	Wed 8/3/16	Thu 8/4/16
2022	Cut-Over to Securus	2.31 days	Wed 8/3/16	Fri 8/5/16
2023	Re-Verify all Features working properly	0.5 hrs	Wed 8/3/16	Wed 8/3/16
2024	Re-Verify phones work, port assignments/call groups set	0.5 hrs	Wed 8/3/16	Wed 8/3/16
2025	Post Cutover QA Checklist & Test Calls Completed	0.5 hrs	Wed 8/3/16	Wed 8/3/16
2026	Notify Facility ITS/WAP is prepared for cutover and functioning correctly	0.5 hrs	Wed 8/3/16	Wed 8/3/16
2027	Cut Sheet distributed to Securus Project Team	0.5 hrs	Wed 8/3/16	Wed 8/3/16
2028	Complete and certify integration with OMS & Commissary Vendor	1 day	Wed 8/3/16	Thu 8/4/16
2029	Cut-over activities by Dorm/Offender Housing Locations	2 days	Wed 8/3/16	Fri 8/5/16

ID	Task Name	Duration	Start	Finish
2030	Quality Control Checklist: Customer Acceptance	1.44 days	Fri 8/5/16	Tue 8/9/16
2031	Customer walk through at facility	0.5 hrs	Fri 8/5/16	Fri 8/5/16
2032	Customer review of Quality Control documentation	0.5 hrs	Fri 8/5/16	Fri 8/5/16
2033	Post Cut-over Activities	1.38 days	Mon 8/8/16	Tue 8/9/16
2034	Final installation diagrams (datacom, electrical, and equipment diagrams)	1 hr	Mon 8/8/16	Mon 8/8/16
2035	Site Cutover Preparation Complete - Ready for Training	1 hr	Mon 8/8/16	Mon 8/8/16
2036	Distribute Implementation Customer Satisfaction Survey	1 hr	Mon 8/8/16	Mon 8/8/16
2037	Training	1 day	Mon 8/8/16	Tue 8/9/16
2038	Onsite Customer ITS/WAP Instructor Led Training	1 day	Mon 8/8/16	Tue 8/9/16
2039	Complete and distribute Training Review forms	1 day	Mon 8/8/16	Tue 8/9/16
2040	Customer Acceptance for NY DOC Correctional Facility	1 day	Mon 8/8/16	Tue 8/9/16
2041	GREENE CORRECTIONAL FACILITY	3.75 days	Thu 8/11/16	Tue 8/16/16
2042	Transport Test & Turn-up Activities with Telecom Provider	1 day	Thu 8/11/16	Thu 8/11/16
2043	Transport turned up with Telecom Provider	1 day	Thu 8/11/16	Thu 8/11/16
2044	Circuit connected to Securus equipment	1 day	Thu 8/11/16	Thu 8/11/16
2045	Installation Support confirmation that Securus equipment on-line	1 day	Thu 8/11/16	Thu 8/11/16
2046	Cut-Over to Securus	2.31 days	Thu 8/11/16	Mon 8/15/16
2047	Re-Verify all Features working properly	0.5 hrs	Thu 8/11/16	Thu 8/11/16
2048	Re-Verify phones work, port assignments/call groups set	0.5 hrs	Thu 8/11/16	Thu 8/11/16
2049	Post Cutover QA Checklist & Test Calls Completed	0.5 hrs	Thu 8/11/16	Thu 8/11/16
2050	Notify Facility ITS/WAP is prepared for cutover and functioning correctly	0.5 hrs	Thu 8/11/16	Thu 8/11/16
2051	Cut Sheet distributed to Securus Project Team	0.5 hrs	Thu 8/11/16	Thu 8/11/16
2052	Complete and certify integration with OMS & Commissary Vendor	1 day	Thu 8/11/16	Fri 8/12/16
2053	Cut-over activities by Dorm/Offender Housing Locations	2 days	Thu 8/11/16	Mon 8/15/16
2054	Quality Control Checklist: Customer Acceptance	1.44 days	Mon 8/15/16	Tue 8/16/16
2055	Customer walk through at facility	0.5 hrs	Mon 8/15/16	Mon 8/15/16
2056	Customer review of Quality Control documentation	0.5 hrs	Mon 8/15/16	Mon 8/15/16
2057	Post Cut-over Activities	1.38 days	Mon 8/15/16	Tue 8/16/16
2058	Final installation diagrams (datacom, electrical, and equipment diagrams)	1 hr	Mon 8/15/16	Mon 8/15/16
2059	Site Cutover Preparation Complete - Ready for Training	1 hr	Mon 8/15/16	Mon 8/15/16
2060	Distribute Implementation Customer Satisfaction Survey	1 hr	Mon 8/15/16	Mon 8/15/16
2061	Training	1 day	Mon 8/15/16	Tue 8/16/16
2062	Onsite Customer ITS/WAP Instructor Led Training	1 day	Mon 8/15/16	Tue 8/16/16
2063	Complete and distribute Training Review forms	1 day	Mon 8/15/16	Tue 8/16/16
2064	Customer Acceptance for NY DOC Correctional Facility	1 day	Mon 8/15/16	Tue 8/16/16
2065	MT MCGREGOR CORRECTIONAL FACILITY	3.75 days	Thu 8/11/16	Tue 8/16/16
2066	Transport Test & Turn-up Activities with Telecom Provider	1 day	Thu 8/11/16	Thu 8/11/16

ID	Task Name	Duration	Start	Finish
2067	Transport turned up with Telecom Provider	1 day	Thu 8/11/16	Thu 8/11/16
2068	Circuit connected to Securus equipment	1 day	Thu 8/11/16	Thu 8/11/16
2069	Installation Support confirmation that Securus equipment on-line	1 day	Thu 8/11/16	Thu 8/11/16
2070	Cut-Over to Securus	2.31 days	Thu 8/11/16	Mon 8/15/16
2071	Re-Verify all Features working properly	0.5 hrs	Thu 8/11/16	Thu 8/11/16
2072	Re-Verify phones work, port assignments/call groups set	0.5 hrs	Thu 8/11/16	Thu 8/11/16
2073	Post Cutover QA Checklist & Test Calls Completed	0.5 hrs	Thu 8/11/16	Thu 8/11/16
2074	Notify Facility ITS/WAP is prepared for cutover and functioning correctly	0.5 hrs	Thu 8/11/16	Thu 8/11/16
2075	Cut Sheet distributed to Securus Project Team	0.5 hrs	Thu 8/11/16	Thu 8/11/16
2076	Complete and certify integration with OMS & Commissary Vendor	1 day	Thu 8/11/16	Fri 8/12/16
2077	Cut-over activities by Dorm/Offender Housing Locations	2 days	Thu 8/11/16	Mon 8/15/16
2078	Quality Control Checkpoint: Customer Acceptance	1.44 days	Mon 8/15/16	Tue 8/16/16
2079	Customer walk through at facility	0.5 hrs	Mon 8/15/16	Mon 8/15/16
2080	Customer review of Quality Control documentation	0.5 hrs	Mon 8/15/16	Mon 8/15/16
2081	Post Cut-over Activities	1.38 days	Mon 8/15/16	Tue 8/16/16
2082	Final installation diagrams (datcom, electrical, and equipment diagrams)	1 hr	Mon 8/15/16	Mon 8/15/16
2083	Site Cutover Preparation Complete - Ready for Training	1 hr	Mon 8/15/16	Mon 8/15/16
2084	Distribute Implementation Customer Satisfaction Survey	1 hr	Mon 8/15/16	Mon 8/15/16
2085	Training	1 day	Mon 8/15/16	Tue 8/16/16
2086	Onsite Customer ITS/WAP Instructor Led Training	1 day	Mon 8/15/16	Tue 8/16/16
2087	Complete and distribute Training Review forms	1 day	Mon 8/15/16	Tue 8/16/16
2088	Customer Acceptance for NY DOC Correctional Facility	1 day	Mon 8/15/16	Tue 8/16/16
2089	HALE CREEK CORRECTIONAL FACILITY	3.75 days	Thu 8/11/16	Tue 8/16/16
2090	Transport Test & Turn-up Activities with Telecom Provider	1 day	Thu 8/11/16	Thu 8/11/16
2091	Transport turned up with Telecom Provider	1 day	Thu 8/11/16	Thu 8/11/16
2092	Circuit connected to Securus equipment	1 day	Thu 8/11/16	Thu 8/11/16
2093	Installation Support confirmation that Securus equipment on-line	1 day	Thu 8/11/16	Thu 8/11/16
2094	Cut-Over to Securus	2.31 days	Thu 8/11/16	Mon 8/15/16
2095	Re-Verify all Features working properly	0.5 hrs	Thu 8/11/16	Thu 8/11/16
2096	Re-Verify phones work, port assignments/call groups set	0.5 hrs	Thu 8/11/16	Thu 8/11/16
2097	Post Cutover QA Checklist & Test Calls Completed	0.5 hrs	Thu 8/11/16	Thu 8/11/16
2098	Notify Facility ITS/WAP is prepared for cutover and functioning correctly	0.5 hrs	Thu 8/11/16	Thu 8/11/16
2099	Cut Sheet distributed to Securus Project Team	0.5 hrs	Thu 8/11/16	Thu 8/11/16
2100	Complete and certify integration with OMS & Commissary Vendor	1 day	Thu 8/11/16	Fri 8/12/16
2101	Cut-over activities by Dorm/Offender Housing Locations	2 days	Thu 8/11/16	Mon 8/15/16
2102	Quality Control Checkpoint: Customer Acceptance	1.44 days	Mon 8/15/16	Tue 8/16/16
2103	Customer walk through at facility	0.5 hrs	Mon 8/15/16	Mon 8/15/16

ID	Task Name	Duration	Start	Finish
2104	Customer review of Quality Control documentation	0.5 hrs	Mon 8/15/16	Mon 8/15/16
2105	Post Cut-over Activities	1.38 days	Mon 8/15/16	Tue 8/16/16
2106	Final installation diagrams (datacom, electrical, and equipment diagrams)	1 hr	Mon 8/15/16	Mon 8/15/16
2107	Site Cutover Preparation Complete - Ready for Training	1 hr	Mon 8/15/16	Mon 8/15/16
2108	Distribute Implementation Customer Satisfaction Survey	1 hr	Mon 8/15/16	Mon 8/15/16
2109	Training	1 day	Mon 8/15/16	Tue 8/16/16
2110	Onsite Customer ITS/WAP Instructor Led Training	1 day	Mon 8/15/16	Tue 8/16/16
2111	Complete and distribute Training Review forms	1 day	Mon 8/15/16	Tue 8/16/16
2112	Customer Acceptance for NY DOC Correctional Facility	1 day	Mon 8/15/16	Tue 8/16/16
2113	MID STATE CORRECTIONAL FACILITY	3.75 days	Thu 8/18/16	Wed 8/24/16
2114	Transport Test & Turn-up Activities with Telecom Provider	1 day	Thu 8/18/16	Fri 8/19/16
2115	Transport turned up with Telecom Provider	1 day	Thu 8/18/16	Fri 8/19/16
2116	Circuit connected to Securus equipment	1 day	Thu 8/18/16	Fri 8/19/16
2117	Installation Support confirmation that Securus equipment on-line	1 day	Thu 8/18/16	Fri 8/19/16
2118	Cut-Over to Securus	2.31 days	Thu 8/18/16	Mon 8/22/16
2119	Re-Verify all Features working properly	0.5 hrs	Thu 8/18/16	Thu 8/18/16
2120	Re-Verify phones work, port assignments/call groups set	0.5 hrs	Thu 8/18/16	Thu 8/18/16
2121	Post Cutover QA Checklist & Test Calls Completed	0.5 hrs	Thu 8/18/16	Thu 8/18/16
2122	Notify Facility ITS/WAP is prepared for cutover and functioning correctly	0.5 hrs	Thu 8/18/16	Thu 8/18/16
2123	Cut Sheet distributed to Securus Project Team	0.5 hrs	Thu 8/18/16	Thu 8/18/16
2124	Complete and certify integration with OMS & Commissary Vendor	1 day	Thu 8/18/16	Fri 8/19/16
2125	Cut-over activities by Dorm/Offender Housing Locations	2 days	Thu 8/18/16	Mon 8/22/16
2126	Quality Control Checkpoint: Customer Acceptance	1.44 days	Mon 8/22/16	Wed 8/24/16
2127	Customer walk through at facility	0.5 hrs	Mon 8/22/16	Mon 8/22/16
2128	Customer review of Quality Control documentation	0.5 hrs	Mon 8/22/16	Mon 8/22/16
2129	Post Cut-over Activities	1.38 days	Mon 8/22/16	Wed 8/24/16
2130	Final installation diagrams (datacom, electrical, and equipment diagrams)	1 hr	Mon 8/22/16	Mon 8/22/16
2131	Site Cutover Preparation Complete - Ready for Training	1 hr	Mon 8/22/16	Mon 8/22/16
2132	Distribute Implementation Customer Satisfaction Survey	1 hr	Tue 8/23/16	Tue 8/23/16
2133	Training	1 day	Tue 8/23/16	Wed 8/24/16
2134	Onsite Customer ITS/WAP Instructor Led Training	1 day	Tue 8/23/16	Wed 8/24/16
2135	Complete and distribute Training Review forms	1 day	Tue 8/23/16	Wed 8/24/16
2136	Customer Acceptance for NY DOC Correctional Facility	1 day	Tue 8/23/16	Wed 8/24/16
2137	MARCY CORRECTIONAL FACILITY	3.75 days	Thu 8/18/16	Wed 8/24/16
2138	Transport Test & Turn-up Activities with Telecom Provider	1 day	Thu 8/18/16	Fri 8/19/16
2139	Transport turned up with Telecom Provider	1 day	Thu 8/18/16	Fri 8/19/16
2140	Circuit connected to Securus equipment	1 day	Thu 8/18/16	Fri 8/19/16

ID	Task Name	Duration	Start	Finish
2141	Installation Support confirmation that Securus equipment on-line	1 day	Thu 8/18/16	Fri 8/19/16
2142	Cut-Over to Securus	2.31 days	Thu 8/18/16	Mon 8/22/16
2143	Re-Verify all Features working properly	0.5 hrs	Thu 8/18/16	Thu 8/18/16
2144	Re-Verify phones work, port assignments/call groups set	0.5 hrs	Thu 8/18/16	Thu 8/18/16
2145	Post Cutover QA Checklist & Test Calls Completed	0.5 hrs	Thu 8/18/16	Thu 8/18/16
2146	Notify Facility ITS/WAP is prepared for cutover and functioning correctly	0.5 hrs	Thu 8/18/16	Thu 8/18/16
2147	Cut Sheet distributed to Securus Project Team	0.5 hrs	Thu 8/18/16	Thu 8/18/16
2148	Complete and certify integration with OMS & Commissary Vendor	1 day	Thu 8/18/16	Fri 8/19/16
2149	Cut-over activities by Dorm/Offender Housing Locations	2 days	Thu 8/18/16	Mon 8/22/16
2150	Quality Control Checkpoint: Customer Acceptance	1.44 days	Mon 8/22/16	Wed 8/24/16
2151	Customer walk through at facility	0.5 hrs	Mon 8/22/16	Mon 8/22/16
2152	Customer review of Quality Control documentation	0.5 hrs	Mon 8/22/16	Mon 8/22/16
2153	Post Cut-over Activities	1.38 days	Mon 8/22/16	Wed 8/24/16
2154	Final installation diagrams (datacom, electrical, and equipment diagrams)	1 hr	Mon 8/22/16	Mon 8/22/16
2155	Site Cutover Preparation Complete - Ready for Training	1 hr	Mon 8/22/16	Mon 8/22/16
2156	Distribute Implementation Customer Satisfaction Survey	1 hr	Tue 8/23/16	Tue 8/23/16
2157	Training	1 day	Tue 8/23/16	Wed 8/24/16
2158	Onsite Customer ITS/WAP Instructor Led Training	1 day	Tue 8/23/16	Wed 8/24/16
2159	Complete and distribute Training Review forms	1 day	Tue 8/23/16	Wed 8/24/16
2160	Customer Acceptance for NY DOC Correctional Facility	1 day	Tue 8/23/16	Wed 8/24/16
2161	MOHAWK CORRECTIONAL FACILITY	3.75 days	Thu 8/18/16	Wed 8/24/16
2162	Transport Test & Turn-up Activities with Telecom Provider	1 day	Thu 8/18/16	Fri 8/19/16
2163	Transport turned up with Telecom Provider	1 day	Thu 8/18/16	Fri 8/19/16
2164	Circuit connected to Securus equipment	1 day	Thu 8/18/16	Fri 8/19/16
2165	Installation Support confirmation that Securus equipment on-line	1 day	Thu 8/18/16	Fri 8/19/16
2166	Cut-Over to Securus	2.31 days	Thu 8/18/16	Mon 8/22/16
2167	Re-Verify all Features working properly	0.5 hrs	Thu 8/18/16	Thu 8/18/16
2168	Re-Verify phones work, port assignments/call groups set	0.5 hrs	Thu 8/18/16	Thu 8/18/16
2169	Post Cutover QA Checklist & Test Calls Completed	0.5 hrs	Thu 8/18/16	Thu 8/18/16
2170	Notify Facility ITS/WAP is prepared for cutover and functioning correctly	0.5 hrs	Thu 8/18/16	Thu 8/18/16
2171	Cut Sheet distributed to Securus Project Team	0.5 hrs	Thu 8/18/16	Thu 8/18/16
2172	Complete and certify integration with OMS & Commissary Vendor	1 day	Thu 8/18/16	Fri 8/19/16
2173	Cut-over activities by Dorm/Offender Housing Locations	2 days	Thu 8/18/16	Mon 8/22/16
2174	Quality Control Checkpoint: Customer Acceptance	1.44 days	Mon 8/22/16	Wed 8/24/16
2175	Customer walk through at facility	0.5 hrs	Mon 8/22/16	Mon 8/22/16
2176	Customer review of Quality Control documentation	0.5 hrs	Mon 8/22/16	Mon 8/22/16
2177	Post Cut-over Activities	1.38 days	Mon 8/22/16	Wed 8/24/16

ID	Task Name	Duration	Start	Finish
2178	Final installation diagrams (datacom, electrical, and equipment diagrams)	1 hr	Mon 8/22/16	Mon 8/22/16
2179	Site Cutover Preparation Complete - Ready for Training	1 hr	Mon 8/22/16	Mon 8/22/16
2180	Distribute Implementation Customer Satisfaction Survey	1 hr	Tue 8/23/16	Tue 8/23/16
2181	Training	1 day	Tue 8/23/16	Wed 8/24/16
2182	Onsite Customer ITS/AWAP Instructor Led Training	1 day	Tue 8/23/16	Wed 8/24/16
2183	Complete and distribute Training Review forms	1 day	Tue 8/23/16	Wed 8/24/16
2184	Customer Acceptance for NY DOC Correctional Facility	1 day	Tue 8/23/16	Wed 8/24/16
2185	BUTLER CORRECTIONAL FACILITY	3.75 days	Thu 8/25/16	Wed 8/31/16
2186	Transport Test & Turn-up Activities with Telecom Provider	1 day	Thu 8/25/16	Fri 8/26/16
2187	Transport turned up with Telecom Provider	1 day	Thu 8/25/16	Fri 8/26/16
2188	Circuit connected to Securus equipment	1 day	Thu 8/25/16	Fri 8/26/16
2189	Installation Support confirmation that Securus equipment on-line	1 day	Thu 8/25/16	Fri 8/26/16
2190	Cut-Over to Securus	2.31 days	Thu 8/25/16	Tue 8/30/16
2191	Re-Verify all Features working properly	0.5 hrs	Thu 8/25/16	Thu 8/25/16
2192	Re-Verify phones work, port assignments/call groups set	0.5 hrs	Thu 8/25/16	Thu 8/25/16
2193	Post Cutover QA Checklist & Test Calls Completed	0.5 hrs	Thu 8/25/16	Thu 8/25/16
2194	Notify Facility ITS/AWAP is prepared for cutover and functioning correctly	0.5 hrs	Thu 8/25/16	Thu 8/25/16
2195	Cut Sheet distributed to Securus Project Team	0.5 hrs	Fri 8/26/16	Fri 8/26/16
2196	Complete and certify integration with OMS & Commissary Vendor	1 day	Fri 8/26/16	Mon 8/29/16
2197	Cut-over activities by Dorm/Offender Housing Locations	2 days	Fri 8/26/16	Tue 8/30/16
2198	Quality Control Checkpoint: Customer Acceptance	1.44 days	Tue 8/30/16	Wed 8/31/16
2199	Customer walk through at facility	0.5 hrs	Tue 8/30/16	Tue 8/30/16
2200	Customer review of Quality Control documentation	0.5 hrs	Tue 8/30/16	Tue 8/30/16
2201	Post Cut-over Activities	1.38 days	Tue 8/30/16	Wed 8/31/16
2202	Final installation diagrams (datacom, electrical, and equipment diagrams)	1 hr	Tue 8/30/16	Tue 8/30/16
2203	Site Cutover Preparation Complete - Ready for Training	1 hr	Tue 8/30/16	Tue 8/30/16
2204	Distribute Implementation Customer Satisfaction Survey	1 hr	Tue 8/30/16	Tue 8/30/16
2205	Training	1 day	Tue 8/30/16	Wed 8/31/16
2206	Onsite Customer ITS/AWAP Instructor Led Training	1 day	Tue 8/30/16	Wed 8/31/16
2207	Complete and distribute Training Review forms	1 day	Tue 8/30/16	Wed 8/31/16
2208	Customer Acceptance for NY DOC Correctional Facility	1 day	Tue 8/30/16	Wed 8/31/16
2209	AUBURN CORRECTIONAL FACILITY	3.75 days	Thu 8/25/16	Wed 8/31/16
2210	Transport Test & Turn-up Activities with Telecom Provider	1 day	Thu 8/25/16	Fri 8/26/16
2211	Transport turned up with Telecom Provider	1 day	Thu 8/25/16	Fri 8/26/16
2212	Circuit connected to Securus equipment	1 day	Thu 8/25/16	Fri 8/26/16
2213	Installation Support confirmation that Securus equipment on-line	1 day	Thu 8/25/16	Fri 8/26/16
2214	Cut-Over to Securus	2.31 days	Thu 8/25/16	Tue 8/30/16

ID	Task Name	Duration	Start	Finish
2215	Re-Verify all Features working properly	0.5 hrs	Thu 8/25/16	Thu 8/25/16
2216	Re-Verify phones work, port assignments/call groups set	0.5 hrs	Thu 8/25/16	Thu 8/25/16
2217	Post Cutover QA Checklist & Test Calls Completed	0.5 hrs	Thu 8/25/16	Thu 8/25/16
2218	Notify Facility ITS/WAP is prepared for cutover and functioning correctly	0.5 hrs	Thu 8/25/16	Thu 8/25/16
2219	Cut Sheet distributed to Securus Project Team	0.5 hrs	Fri 8/26/16	Fri 8/26/16
2220	Complete and certify integration with OMS & Commissary Vendor	1 day	Fri 8/26/16	Mon 8/29/16
2221	Cut-over activities by Dorm/Offender Housing Locations	2 days	Fri 8/26/16	Tue 8/30/16
2222	Quality Control Checkpoint: Customer Acceptance	1.44 days	Tue 8/30/16	Wed 8/31/16
2223	Customer walk through at facility	0.5 hrs	Tue 8/30/16	Tue 8/30/16
2224	Customer review of Quality Control documentation	0.5 hrs	Tue 8/30/16	Tue 8/30/16
2225	Post Cut-over Activities	1.38 days	Tue 8/30/16	Wed 8/31/16
2226	Final installation diagrams (datacom, electrical, and equipment diagrams)	1 hr	Tue 8/30/16	Tue 8/30/16
2227	Site Cutover Preparation Complete - Ready for Training	1 hr	Tue 8/30/16	Tue 8/30/16
2228	Distribute Implementation Customer Satisfaction Survey	1 hr	Tue 8/30/16	Tue 8/30/16
2229	Training	1 day	Tue 8/30/16	Wed 8/31/16
2230	Onsite Customer ITS/WAP Instructor Led Training	1 day	Tue 8/30/16	Wed 8/31/16
2231	Complete and distribute Training Review forms	1 day	Tue 8/30/16	Wed 8/31/16
2232	Customer Acceptance for NY DOC Correctional Facility	1 day	Tue 8/30/16	Wed 8/31/16
2233	CAYUGA CORRECTIONAL FACILITY	3.75 days	Thu 8/25/16	Wed 8/31/16
2234	Transport Test & Turn-up Activities with Telecom Provider	1 day	Thu 8/25/16	Fri 8/26/16
2235	Transport turned up with Telecom Provider	1 day	Thu 8/25/16	Fri 8/26/16
2236	Circuit connected to Securus equipment	1 day	Thu 8/25/16	Fri 8/26/16
2237	Installation Support confirmation that Securus equipment on-line	1 day	Thu 8/25/16	Fri 8/26/16
2238	Cut-Over to Securus	2.31 days	Thu 8/25/16	Tue 8/30/16
2239	Re-Verify all Features working properly	0.5 hrs	Thu 8/25/16	Thu 8/25/16
2240	Re-Verify phones work, port assignments/call groups set	0.5 hrs	Thu 8/25/16	Thu 8/25/16
2241	Post Cutover QA Checklist & Test Calls Completed	0.5 hrs	Thu 8/25/16	Thu 8/25/16
2242	Notify Facility ITS/WAP is prepared for cutover and functioning correctly	0.5 hrs	Thu 8/25/16	Thu 8/25/16
2243	Cut Sheet distributed to Securus Project Team	0.5 hrs	Fri 8/26/16	Fri 8/26/16
2244	Complete and certify integration with OMS & Commissary Vendor	1 day	Fri 8/26/16	Mon 8/29/16
2245	Cut-over activities by Dorm/Offender Housing Locations	2 days	Fri 8/26/16	Tue 8/30/16
2246	Quality Control Checkpoint: Customer Acceptance	1.44 days	Tue 8/30/16	Wed 8/31/16
2247	Customer walk through at facility	0.5 hrs	Tue 8/30/16	Tue 8/30/16
2248	Customer review of Quality Control documentation	0.5 hrs	Tue 8/30/16	Tue 8/30/16
2249	Post Cut-over Activities	1.38 days	Tue 8/30/16	Wed 8/31/16
2250	Final installation diagrams (datacom, electrical, and equipment diagrams)	1 hr	Tue 8/30/16	Tue 8/30/16
2251	Site Cutover Preparation Complete - Ready for Training	1 hr	Tue 8/30/16	Tue 8/30/16

ID	Task Name	Duration	Start	Finish
2252	Distribute Implementation Customer Satisfaction Survey	1 hr	Tue 8/30/16	Tue 8/30/16
2253	Training	1 day	Tue 8/30/16	Wed 8/31/16
2254	Onsite Customer ITS/WAP Instructor Led Training	1 day	Tue 8/30/16	Wed 8/31/16
2255	Complete and distribute Training Review forms	1 day	Tue 8/30/16	Wed 8/31/16
2256	Customer Acceptance for NY DOC Correctional Facility	1 day	Tue 8/30/16	Wed 8/31/16
2257	Installation Region 3 Facilities	25.25 days	Wed 7/27/16	Wed 8/31/16
2258	LAKEVIEW SHOCK INCARCERATION CORRECTIONAL FACILITY	3.75 days	Wed 7/27/16	Mon 8/1/16
2259	Transport Test & Turn-up Activities with Telecom Provider	1 day	Wed 7/27/16	Thu 7/28/16
2260	Transport turned up with Telecom Provider	1 day	Wed 7/27/16	Thu 7/28/16
2261	Circuit connected to Securus equipment	1 day	Wed 7/27/16	Thu 7/28/16
2262	Installation Support confirmation that Securus equipment on-line	1 day	Wed 7/27/16	Thu 7/28/16
2263	Cut-Over to Securus	2.31 days	Wed 7/27/16	Fri 7/29/16
2264	Re-Verify all Features working properly	0.5 hrs	Wed 7/27/16	Wed 7/27/16
2265	Re-Verify phones work, port assignments/call groups set	0.5 hrs	Wed 7/27/16	Wed 7/27/16
2266	Post Cutover QA Checklist & Test Calls Completed	0.5 hrs	Wed 7/27/16	Wed 7/27/16
2267	Notify Facility ITS/WAP is prepared for cutover and functioning correctly	0.5 hrs	Wed 7/27/16	Wed 7/27/16
2268	Cut Sheet distributed to Securus Project Team	0.5 hrs	Wed 7/27/16	Wed 7/27/16
2269	Complete and certify integration with OMS & Commissary Vendor	1 day	Wed 7/27/16	Thu 7/28/16
2270	Cut-over activities by Dorm/Offender Housing Locations	2 days	Wed 7/27/16	Fri 7/29/16
2271	Quality Control Checkpoint: Customer Acceptance	1.44 days	Fri 7/29/16	Mon 8/1/16
2272	Customer walk through at facility	0.5 hrs	Fri 7/29/16	Fri 7/29/16
2273	Customer review of Quality Control documentation	0.5 hrs	Fri 7/29/16	Fri 7/29/16
2274	Post Cut-over Activities	1.38 days	Fri 7/29/16	Mon 8/1/16
2275	Final installation diagrams (datacom, electrical, and equipment diagrams)	1 hr	Fri 7/29/16	Fri 7/29/16
2276	Site Cutover Preparation Complete - Ready for Training	1 hr	Fri 7/29/16	Fri 7/29/16
2277	Distribute Implementation Customer Satisfaction Survey	1 hr	Fri 7/29/16	Fri 7/29/16
2278	Training	1 day	Mon 8/1/16	Mon 8/1/16
2279	Onsite Customer ITS/WAP Instructor Led Training	1 day	Mon 8/1/16	Mon 8/1/16
2280	Complete and distribute Training Review forms	1 day	Mon 8/1/16	Mon 8/1/16
2281	Customer Acceptance for NY DOC Correctional Facility	1 day	Mon 8/1/16	Mon 8/1/16
2282	GOWANDA CORRECTIONAL FACILITY	3.75 days	Wed 7/27/16	Mon 8/1/16
2283	Transport Test & Turn-up Activities with Telecom Provider	1 day	Wed 7/27/16	Thu 7/28/16
2284	Transport turned up with Telecom Provider	1 day	Wed 7/27/16	Thu 7/28/16
2285	Circuit connected to Securus equipment	1 day	Wed 7/27/16	Thu 7/28/16
2286	Installation Support confirmation that Securus equipment on-line	1 day	Wed 7/27/16	Thu 7/28/16
2287	Cut-Over to Securus	2.31 days	Wed 7/27/16	Fri 7/29/16
2288	Re-Verify all Features working properly	0.5 hrs	Wed 7/27/16	Wed 7/27/16

ID	Task Name	Duration	Start	Finish
2289	Re-Verify phones work, port assignments/call groups set	0.5 hrs	Wed 7/27/16	Wed 7/27/16
2290	Post Cutover QA Checklist & Test Calls Completed	0.5 hrs	Wed 7/27/16	Wed 7/27/16
2291	Notify Facility ITS/WAP is prepared for cutover and functioning correctly	0.5 hrs	Wed 7/27/16	Wed 7/27/16
2292	Cut Sheet distributed to Securus Project Team	0.5 hrs	Wed 7/27/16	Wed 7/27/16
2293	Complete and certify integration with OMS & Commissary Vendor	1 day	Wed 7/27/16	Thu 7/28/16
2294	Cut-over activities by Dorm/Offender Housing Locations	2 days	Wed 7/27/16	Fri 7/29/16
2295	Quality Control Checkpoint: Customer Acceptance	1.44 days	Fri 7/29/16	Mon 8/1/16
2296	Customer walk through at facility	0.5 hrs	Fri 7/29/16	Fri 7/29/16
2297	Customer review of Quality Control documentation	0.5 hrs	Fri 7/29/16	Fri 7/29/16
2298	Post Cut-over Activities	1.38 days	Fri 7/29/16	Mon 8/1/16
2299	Final installation diagrams (datacom, electrical, and equipment diagrams)	1 hr	Fri 7/29/16	Fri 7/29/16
2300	Site Cutover Preparation Complete - Ready for Training	1 hr	Fri 7/29/16	Fri 7/29/16
2301	Distribute Implementation Customer Satisfaction Survey	1 hr	Fri 7/29/16	Fri 7/29/16
2302	Training	1 day	Mon 8/1/16	Mon 8/1/16
2303	Onsite Customer ITS/WAP Instructor Led Training	1 day	Mon 8/1/16	Mon 8/1/16
2304	Complete and distribute Training Review forms	1 day	Mon 8/1/16	Mon 8/1/16
2305	Customer Acceptance for NY DOC Correctional Facility	1 day	Mon 8/1/16	Mon 8/1/16
2306	COLLINS CORRECTIONAL FACILITY	3.75 days	Wed 7/27/16	Mon 8/1/16
2307	Transport Test & Turn-up Activities with Telecom Provider	1 day	Wed 7/27/16	Thu 7/28/16
2308	Transport turned up with Telecom Provider	1 day	Wed 7/27/16	Thu 7/28/16
2309	Circuit connected to Securus equipment	1 day	Wed 7/27/16	Thu 7/28/16
2310	Installation Support confirmation that Securus equipment on-line	1 day	Wed 7/27/16	Thu 7/28/16
2311	Cut-Over to Securus	2.31 days	Wed 7/27/16	Fri 7/29/16
2312	Re-Verify all Features working properly	0.5 hrs	Wed 7/27/16	Wed 7/27/16
2313	Re-Verify phones work, port assignments/call groups set	0.5 hrs	Wed 7/27/16	Wed 7/27/16
2314	Post Cutover QA Checklist & Test Calls Completed	0.5 hrs	Wed 7/27/16	Wed 7/27/16
2315	Notify Facility ITS/WAP is prepared for cutover and functioning correctly	0.5 hrs	Wed 7/27/16	Wed 7/27/16
2316	Cut Sheet distributed to Securus Project Team	0.5 hrs	Wed 7/27/16	Wed 7/27/16
2317	Complete and certify integration with OMS & Commissary Vendor	1 day	Wed 7/27/16	Thu 7/28/16
2318	Cut-over activities by Dorm/Offender Housing Locations	2 days	Wed 7/27/16	Fri 7/29/16
2319	Quality Control Checkpoint: Customer Acceptance	1.44 days	Fri 7/29/16	Mon 8/1/16
2320	Customer walk through at facility	0.5 hrs	Fri 7/29/16	Fri 7/29/16
2321	Customer review of Quality Control documentation	0.5 hrs	Fri 7/29/16	Fri 7/29/16
2322	Post Cut-over Activities	1.38 days	Fri 7/29/16	Mon 8/1/16
2323	Final installation diagrams (datacom, electrical, and equipment diagrams)	1 hr	Fri 7/29/16	Fri 7/29/16
2324	Site Cutover Preparation Complete - Ready for Training	1 hr	Fri 7/29/16	Fri 7/29/16
2325	Distribute Implementation Customer Satisfaction Survey	1 hr	Fri 7/29/16	Fri 7/29/16

ID	Task Name	Duration	Start	Finish
2326	Training	1 day	Mon 8/1/16	Mon 8/1/16
2327	Onsite Customer ITS/WAP Instructor Led Training	1 day	Mon 8/1/16	Mon 8/1/16
2328	Complete and distribute Training Review forms	1 day	Mon 8/1/16	Mon 8/1/16
2329	Customer Acceptance for NY DOC Correctional Facility	1 day	Mon 8/1/16	Mon 8/1/16
2330	WENDE CORRECTIONAL FACILITY	3.75 days	Wed 8/3/16	Tue 8/9/16
2331	Transport Test & Turn-up Activities with Telecom Provider	1 day	Wed 8/3/16	Thu 8/4/16
2332	Transport turned up with Telecom Provider	1 day	Wed 8/3/16	Thu 8/4/16
2333	Circuit connected to Securus equipment	1 day	Wed 8/3/16	Thu 8/4/16
2334	Installation Support confirmation that Securus equipment on-line	1 day	Wed 8/3/16	Thu 8/4/16
2335	Cut-Over to Securus	2.31 days	Wed 8/3/16	Fri 8/5/16
2336	Re-Verify all Features working properly	0.5 hrs	Wed 8/3/16	Wed 8/3/16
2337	Re-Verify phones work, port assignments/call groups set	0.5 hrs	Wed 8/3/16	Wed 8/3/16
2338	Post Cutover QA Checklist & Test Calls Completed	0.5 hrs	Wed 8/3/16	Wed 8/3/16
2339	Notify Facility ITS/WAP is prepared for cutover and functioning correctly	0.5 hrs	Wed 8/3/16	Wed 8/3/16
2340	Cut Sheet distributed to Securus Project Team	0.5 hrs	Wed 8/3/16	Wed 8/3/16
2341	Complete and certify integration with OMS & Commissary Vendor	1 day	Wed 8/3/16	Thu 8/4/16
2342	Cut-over activities by Dorm/Offender Housing Locations	2 days	Wed 8/3/16	Fri 8/5/16
2343	Quality Control Checkpoint: Customer Acceptance	1.44 days	Fri 8/5/16	Tue 8/9/16
2344	Customer walk through at facility	0.5 hrs	Fri 8/5/16	Fri 8/5/16
2345	Customer review of Quality Control documentation	0.5 hrs	Fri 8/5/16	Fri 8/5/16
2346	Post Cut-over Activities	1.38 days	Mon 8/8/16	Tue 8/9/16
2347	Final installation diagrams (datacom, electrical, and equipment diagrams)	1 hr	Mon 8/8/16	Mon 8/8/16
2348	Site Cutover Preparation Complete - Ready for Training	1 hr	Mon 8/8/16	Mon 8/8/16
2349	Distribute Implementation Customer Satisfaction Survey	1 hr	Mon 8/8/16	Mon 8/8/16
2350	Training	1 day	Mon 8/8/16	Tue 8/9/16
2351	Onsite Customer ITS/WAP Instructor Led Training	1 day	Mon 8/8/16	Tue 8/9/16
2352	Complete and distribute Training Review forms	1 day	Mon 8/8/16	Tue 8/9/16
2353	Customer Acceptance for NY DOC Correctional Facility	1 day	Mon 8/8/16	Tue 8/9/16
2354	ATTICA CORRECTIONAL FACILITY	3.75 days	Wed 8/3/16	Tue 8/9/16
2355	Transport Test & Turn-up Activities with Telecom Provider	1 day	Wed 8/3/16	Thu 8/4/16
2356	Transport turned up with Telecom Provider	1 day	Wed 8/3/16	Thu 8/4/16
2357	Circuit connected to Securus equipment	1 day	Wed 8/3/16	Thu 8/4/16
2358	Installation Support confirmation that Securus equipment on-line	1 day	Wed 8/3/16	Thu 8/4/16
2359	Cut-Over to Securus	2.31 days	Wed 8/3/16	Fri 8/5/16
2360	Re-Verify all Features working properly	0.5 hrs	Wed 8/3/16	Wed 8/3/16
2361	Re-Verify phones work, port assignments/call groups set	0.5 hrs	Wed 8/3/16	Wed 8/3/16
2362	Post Cutover QA Checklist & Test Calls Completed	0.5 hrs	Wed 8/3/16	Wed 8/3/16

ID	Task Name	Duration	Start	Finish
2363	Notify Facility ITS/WAP is prepared for cutover and functioning correctly	0.5 hrs	Wed 8/3/16	Wed 8/3/16
2364	Cut Sheet distributed to Securus Project Team	0.5 hrs	Wed 8/3/16	Wed 8/3/16
2365	Complete and certify integration with OMS & Commissary Vendor	1 day	Wed 8/3/16	Thu 8/4/16
2366	Cut-over activities by Dorm/Offender Housing Locations	2 days	Wed 8/3/16	Fri 8/5/16
2367	Quality Control Checkpoint: Customer Acceptance	1.44 days	Fri 8/5/16	Tue 8/9/16
2368	Customer walk through at facility	0.5 hrs	Fri 8/5/16	Fri 8/5/16
2369	Customer review of Quality Control documentation	0.5 hrs	Fri 8/5/16	Fri 8/5/16
2370	Post Cut-over Activities	1.38 days	Mon 8/8/16	Tue 8/9/16
2371	Final installation diagrams (datacom, electrical, and equipment diagrams)	1 hr	Mon 8/8/16	Mon 8/8/16
2372	Site Cutover Preparation Complete - Ready for Training	1 hr	Mon 8/8/16	Mon 8/8/16
2373	Distribute Implementation Customer Satisfaction Survey	1 hr	Mon 8/8/16	Mon 8/8/16
2374	Training	1 day	Mon 8/8/16	Tue 8/9/16
2375	Onsite Customer ITS/WAP Instructor Led Training	1 day	Mon 8/8/16	Tue 8/9/16
2376	Complete and distribute Training Review forms	1 day	Mon 8/8/16	Tue 8/9/16
2377	Customer Acceptance for NY DOC Correctional Facility	1 day	Mon 8/8/16	Tue 8/9/16
2378	WYOMING CORRECTIONAL FACILITY	3.75 days	Wed 8/3/16	Tue 8/9/16
2379	Transport Test & Turn-up Activities with Telecom Provider	1 day	Wed 8/3/16	Thu 8/4/16
2380	Transport turned up with Telecom Provider	1 day	Wed 8/3/16	Thu 8/4/16
2381	Circuit connected to Securus equipment	1 day	Wed 8/3/16	Thu 8/4/16
2382	Installation Support confirmation that Securus equipment on-line	1 day	Wed 8/3/16	Thu 8/4/16
2383	Cut-Over to Securus	2.31 days	Wed 8/3/16	Fri 8/5/16
2384	Re-Verify all Features working properly	0.5 hrs	Wed 8/3/16	Wed 8/3/16
2385	Re-Verify phones work, port assignments/call groups set	0.5 hrs	Wed 8/3/16	Wed 8/3/16
2386	Post Cutover QA Checklist & Test Calls Completed	0.5 hrs	Wed 8/3/16	Wed 8/3/16
2387	Notify Facility ITS/WAP is prepared for cutover and functioning correctly	0.5 hrs	Wed 8/3/16	Wed 8/3/16
2388	Cut Sheet distributed to Securus Project Team	0.5 hrs	Wed 8/3/16	Wed 8/3/16
2389	Complete and certify integration with OMS & Commissary Vendor	1 day	Wed 8/3/16	Thu 8/4/16
2390	Cut-over activities by Dorm/Offender Housing Locations	2 days	Wed 8/3/16	Fri 8/5/16
2391	Quality Control Checkpoint: Customer Acceptance	1.44 days	Fri 8/5/16	Tue 8/9/16
2392	Customer walk through at facility	0.5 hrs	Fri 8/5/16	Fri 8/5/16
2393	Customer review of Quality Control documentation	0.5 hrs	Fri 8/5/16	Fri 8/5/16
2394	Post Cut-over Activities	1.38 days	Mon 8/8/16	Tue 8/9/16
2395	Final installation diagrams (datacom, electrical, and equipment diagrams)	1 hr	Mon 8/8/16	Mon 8/8/16
2396	Site Cutover Preparation Complete - Ready for Training	1 hr	Mon 8/8/16	Mon 8/8/16
2397	Distribute Implementation Customer Satisfaction Survey	1 hr	Mon 8/8/16	Mon 8/8/16
2398	Training	1 day	Mon 8/8/16	Tue 8/9/16
2399	Onsite Customer ITS/WAP Instructor Led Training	1 day	Mon 8/8/16	Tue 8/9/16

ID	Task Name	Duration	Start	Finish
2400	Complete and distribute Training Review forms	1 day	Mon 8/8/16	Tue 8/9/16
2401	Customer Acceptance for NY DOC Correctional Facility	1 day	Mon 8/8/16	Tue 8/9/16
2402	ORLEAN'S CORRECTIONAL FACILITY	3.75 days	Thu 8/11/16	Tue 8/16/16
2403	Transport Test & Turn-up Activities with Telecom Provider	1 day	Thu 8/11/16	Thu 8/11/16
2404	Transport turned up with Telecom Provider	1 day	Thu 8/11/16	Thu 8/11/16
2405	Circuit connected to Securus equipment	1 day	Thu 8/11/16	Thu 8/11/16
2406	Installation Support confirmation that Securus equipment on-line	1 day	Thu 8/11/16	Thu 8/11/16
2407	Cut-Over to Securus	2.31 days	Thu 8/11/16	Mon 8/15/16
2408	Re-Verify all Features working properly	0.5 hrs	Thu 8/11/16	Thu 8/11/16
2409	Re-Verify phones work, port assignments/call groups set	0.5 hrs	Thu 8/11/16	Thu 8/11/16
2410	Post Cutover QA Checklist & Test Calls Completed	0.5 hrs	Thu 8/11/16	Thu 8/11/16
2411	Notify Facility ITS/WAP is prepared for cutover and functioning correctly	0.5 hrs	Thu 8/11/16	Thu 8/11/16
2412	Cut Sheet distributed to Securus Project Team	0.5 hrs	Thu 8/11/16	Thu 8/11/16
2413	Complete and certify integration with OMS & Commissary Vendor	1 day	Thu 8/11/16	Fri 8/12/16
2414	Cut-over activities by Dorm/Offender Housing Locations	2 days	Thu 8/11/16	Mon 8/15/16
2415	Quality Control Checkpoint: Customer Acceptance	1.44 days	Mon 8/15/16	Tue 8/16/16
2416	Customer walk through at facility	0.5 hrs	Mon 8/15/16	Mon 8/15/16
2417	Customer review of Quality Control documentation	0.5 hrs	Mon 8/15/16	Mon 8/15/16
2418	Post Cut-over Activities	1.38 days	Mon 8/15/16	Tue 8/16/16
2419	Final installation diagrams (datacom, electrical, and equipment diagrams)	1 hr	Mon 8/15/16	Mon 8/15/16
2420	Site Cutover Preparation Complete - Ready for Training	1 hr	Mon 8/15/16	Mon 8/15/16
2421	Distribute Implementation Customer Satisfaction Survey	1 hr	Mon 8/15/16	Mon 8/15/16
2422	Training	1 day	Mon 8/15/16	Tue 8/16/16
2423	Onsite Customer ITS/WAP Instructor Led Training	1 day	Mon 8/15/16	Tue 8/16/16
2424	Complete and distribute Training Review forms	1 day	Mon 8/15/16	Tue 8/16/16
2425	Customer Acceptance for NY DOC Correctional Facility	1 day	Mon 8/15/16	Tue 8/16/16
2426	ALBION CORRECTIONAL FACILITY	3.75 days	Thu 8/11/16	Tue 8/16/16
2427	Transport Test & Turn-up Activities with Telecom Provider	1 day	Thu 8/11/16	Thu 8/11/16
2428	Transport turned up with Telecom Provider	1 day	Thu 8/11/16	Thu 8/11/16
2429	Circuit connected to Securus equipment	1 day	Thu 8/11/16	Thu 8/11/16
2430	Installation Support confirmation that Securus equipment on-line	1 day	Thu 8/11/16	Thu 8/11/16
2431	Cut-Over to Securus	2.31 days	Thu 8/11/16	Mon 8/15/16
2432	Re-Verify all Features working properly	0.5 hrs	Thu 8/11/16	Thu 8/11/16
2433	Re-Verify phones work, port assignments/call groups set	0.5 hrs	Thu 8/11/16	Thu 8/11/16
2434	Post Cutover QA Checklist & Test Calls Completed	0.5 hrs	Thu 8/11/16	Thu 8/11/16
2435	Notify Facility ITS/WAP is prepared for cutover and functioning correctly	0.5 hrs	Thu 8/11/16	Thu 8/11/16
2436	Cut Sheet distributed to Securus Project Team	0.5 hrs	Thu 8/11/16	Thu 8/11/16

ID	Task Name	Duration	Start	Finish
2437	Complete and certify integration with OMS & Commissary Vendor	1 day	Thu 8/11/16	Fri 8/12/16
2438	Cutover activities by Dorm/Offender Housing Locations	2 days	Thu 8/11/16	Mon 8/15/16
2439	Quality Control Checkpoint: Customer Acceptance	1.44 days	Mon 8/15/16	Tue 8/16/16
2440	Customer walk through at facility	0.5 hrs	Mon 8/15/16	Mon 8/15/16
2441	Customer review of Quality Control documentation	0.5 hrs	Mon 8/15/16	Mon 8/15/16
2442	Post Cut-over Activities	1.38 days	Mon 8/15/16	Tue 8/16/16
2443	Final installation diagrams (datacom, electrical, and equipment diagrams)	1 hr	Mon 8/15/16	Mon 8/15/16
2444	Site Cutover Preparation Complete - Ready for Training	1 hr	Mon 8/15/16	Mon 8/15/16
2445	Distribute Implementation Customer Satisfaction Survey	1 hr	Mon 8/15/16	Mon 8/15/16
2446	Training	1 day	Mon 8/15/16	Tue 8/16/16
2447	Onsite Customer ITS/WAP Instructor Led Training	1 day	Mon 8/15/16	Tue 8/16/16
2448	Complete and distribute Training Review forms	1 day	Mon 8/15/16	Tue 8/16/16
2449	Customer Acceptance for NY DOC Correctional Facility	1 day	Mon 8/15/16	Tue 8/16/16
2450	ROCHESTER CORRECTIONAL FACILITY	3.75 days	Thu 8/11/16	Tue 8/16/16
2451	Transport Test & Turn-up Activities with Telecom Provider	1 day	Thu 8/11/16	Thu 8/11/16
2452	Transport turned up with Telecom Provider	1 day	Thu 8/11/16	Thu 8/11/16
2453	Circuit connected to Securus equipment	1 day	Thu 8/11/16	Thu 8/11/16
2454	Installation Support confirmation that Securus equipment on-line	1 day	Thu 8/11/16	Thu 8/11/16
2455	Cut-Over to Securus	2.31 days	Thu 8/11/16	Mon 8/15/16
2456	Re-Verify all Features working properly	0.5 hrs	Thu 8/11/16	Thu 8/11/16
2457	Re-Verify phones work, port assignments/call groups set	0.5 hrs	Thu 8/11/16	Thu 8/11/16
2458	Post Cutover QA Checklist & Test Calls Completed	0.5 hrs	Thu 8/11/16	Thu 8/11/16
2459	Notify Facility ITS/WAP is prepared for cutover and functioning correctly	0.5 hrs	Thu 8/11/16	Thu 8/11/16
2460	Cut Sheet distributed to Securus Project Team	0.5 hrs	Thu 8/11/16	Thu 8/11/16
2461	Complete and certify integration with OMS & Commissary Vendor	1 day	Thu 8/11/16	Fri 8/12/16
2462	Cutover activities by Dorm/Offender Housing Locations	2 days	Thu 8/11/16	Mon 8/15/16
2463	Quality Control Checkpoint: Customer Acceptance	1.44 days	Mon 8/15/16	Tue 8/16/16
2464	Customer walk through at facility	0.5 hrs	Mon 8/15/16	Mon 8/15/16
2465	Customer review of Quality Control documentation	0.5 hrs	Mon 8/15/16	Mon 8/15/16
2466	Post Cut-over Activities	1.38 days	Mon 8/15/16	Tue 8/16/16
2467	Final installation diagrams (datacom, electrical, and equipment diagrams)	1 hr	Mon 8/15/16	Mon 8/15/16
2468	Site Cutover Preparation Complete - Ready for Training	1 hr	Mon 8/15/16	Mon 8/15/16
2469	Distribute Implementation Customer Satisfaction Survey	1 hr	Mon 8/15/16	Mon 8/15/16
2470	Training	1 day	Mon 8/15/16	Tue 8/16/16
2471	Onsite Customer ITS/WAP Instructor Led Training	1 day	Mon 8/15/16	Tue 8/16/16
2472	Complete and distribute Training Review forms	1 day	Mon 8/15/16	Tue 8/16/16
2473	Customer Acceptance for NY DOC Correctional Facility	1 day	Mon 8/15/16	Tue 8/16/16

ID	Task Name	Duration	Start	Finish
2474	LIVINGSTON CORRECTIONAL FACILITY	3.75 days	Thu 8/18/16	Wed 8/24/16
2475	Transport Test & Turn-up Activities with Telecom Provider	1 day	Thu 8/18/16	Fri 8/19/16
2476	Transport turned up with Telecom Provider	1 day	Thu 8/18/16	Fri 8/19/16
2477	Circuit connected to Securus equipment	1 day	Thu 8/18/16	Fri 8/19/16
2478	Installation Support confirmation that Securus equipment on-line	1 day	Thu 8/18/16	Fri 8/19/16
2479	Cut-Over to Securus	2.31 days	Thu 8/18/16	Mon 8/22/16
2480	Re-Verify all Features working properly	0.5 hrs	Thu 8/18/16	Thu 8/18/16
2481	Re-Verify phones work, port assignments/call groups set	0.5 hrs	Thu 8/18/16	Thu 8/18/16
2482	Post Cutover QA Checklist & Test Calls Completed	0.5 hrs	Thu 8/18/16	Thu 8/18/16
2483	Notify Facility ITS/WAP is prepared for cutover and functioning correctly	0.5 hrs	Thu 8/18/16	Thu 8/18/16
2484	Cut Sheet distributed to Securus Project Team	0.5 hrs	Thu 8/18/16	Thu 8/18/16
2485	Complete and certify integration with OMS & Commissary Vendor	1 day	Thu 8/18/16	Fri 8/19/16
2486	Cut-over activities by Dorm/Offender Housing Locations	2 days	Thu 8/18/16	Fri 8/19/16
2487	Quality Control Checkpoint: Customer Acceptance	1.44 days	Mon 8/22/16	Wed 8/24/16
2488	Customer walk through at facility	0.5 hrs	Mon 8/22/16	Mon 8/22/16
2489	Customer review of Quality Control documentation	0.5 hrs	Mon 8/22/16	Mon 8/22/16
2490	Post Cut-over Activities	1.38 days	Mon 8/22/16	Wed 8/24/16
2491	Final installation diagrams (datacom, electrical, and equipment diagrams)	1 hr	Mon 8/22/16	Mon 8/22/16
2492	Site Cutover Preparation Complete - Ready for Training	1 hr	Mon 8/22/16	Mon 8/22/16
2493	Distribute Implementation Customer Satisfaction Survey	1 hr	Tue 8/23/16	Tue 8/23/16
2494	Training	1 day	Tue 8/23/16	Wed 8/24/16
2495	Onsite Customer ITS/WAP Instructor Led Training	1 day	Tue 8/23/16	Wed 8/24/16
2496	Complete and distribute Training Review forms	1 day	Tue 8/23/16	Wed 8/24/16
2497	Customer Acceptance for NY DOC Correctional Facility	1 day	Tue 8/23/16	Wed 8/24/16
2498	GROVELAND CORRECTIONAL FACILITY	3.75 days	Thu 8/18/16	Wed 8/24/16
2499	Transport Test & Turn-up Activities with Telecom Provider	1 day	Thu 8/18/16	Fri 8/19/16
2500	Transport turned up with Telecom Provider	1 day	Thu 8/18/16	Fri 8/19/16
2501	Circuit connected to Securus equipment	1 day	Thu 8/18/16	Fri 8/19/16
2502	Installation Support confirmation that Securus equipment on-line	1 day	Thu 8/18/16	Fri 8/19/16
2503	Cut-Over to Securus	2.31 days	Thu 8/18/16	Mon 8/22/16
2504	Re-Verify all Features working properly	0.5 hrs	Thu 8/18/16	Thu 8/18/16
2505	Re-Verify phones work, port assignments/call groups set	0.5 hrs	Thu 8/18/16	Thu 8/18/16
2506	Post Cutover QA Checklist & Test Calls Completed	0.5 hrs	Thu 8/18/16	Thu 8/18/16
2507	Notify Facility ITS/WAP is prepared for cutover and functioning correctly	0.5 hrs	Thu 8/18/16	Thu 8/18/16
2508	Cut Sheet distributed to Securus Project Team	0.5 hrs	Thu 8/18/16	Thu 8/18/16
2509	Complete and certify integration with OMS & Commissary Vendor	1 day	Thu 8/18/16	Fri 8/19/16
2510	Cut-over activities by Dorm/Offender Housing Locations	2 days	Thu 8/18/16	Mon 8/22/16

ID	Task Name	Duration	Start	Finish
2511	Quality Control Checkpoint: Customer Acceptance	1.44 days	Mon 8/22/16	Wed 8/24/16
2512	Customer walk through at facility	0.5 hrs	Mon 8/22/16	Mon 8/22/16
2513	Customer review of Quality Control documentation	0.5 hrs	Mon 8/22/16	Mon 8/22/16
2514	Post Cut-over Activities	1.38 days	Mon 8/22/16	Wed 8/24/16
2515	Final installation diagrams (datacom, electrical, and equipment diagrams)	1 hr	Mon 8/22/16	Mon 8/22/16
2516	Site Cutover Preparation Complete - Ready for Training	1 hr	Mon 8/22/16	Mon 8/22/16
2517	Distribute Implementation Customer Satisfaction Survey	1 hr	Tue 8/23/16	Tue 8/23/16
2518	Training	1 day	Tue 8/23/16	Wed 8/24/16
2519	Onsite Customer ITS/WAP Instructor Led Training	1 day	Tue 8/23/16	Wed 8/24/16
2520	Complete and distribute Training Review forms	1 day	Tue 8/23/16	Wed 8/24/16
2521	Customer Acceptance for NY DOC Correctional Facility	1 day	Tue 8/23/16	Wed 8/24/16
2522	FIVE POINTS CORRECTIONAL FACILITY	3.75 days	Tue 8/23/16	Wed 8/24/16
2523	Transport Test & Turn-up Activities with Telecom Provider	1 day	Thu 8/18/16	Wed 8/24/16
2524	Transport turned up with Telecom Provider	1 day	Thu 8/18/16	Fri 8/19/16
2525	Circuit connected to Securus equipment	1 day	Thu 8/18/16	Fri 8/19/16
2526	Installation Support confirmation that Securus equipment on-line	1 day	Thu 8/18/16	Fri 8/19/16
2527	Cut-Over to Securus	2.31 days	Thu 8/18/16	Mon 8/22/16
2528	Re-Verify all Features working properly	0.5 hrs	Thu 8/18/16	Thu 8/18/16
2529	Re-Verify phones work, port assignments/call groups set	0.5 hrs	Thu 8/18/16	Thu 8/18/16
2530	Post Cutover QA Checklist & Test Calls Completed	0.5 hrs	Thu 8/18/16	Thu 8/18/16
2531	Notify Facility ITS/WAP is prepared for cutover and functioning correctly	0.5 hrs	Thu 8/18/16	Thu 8/18/16
2532	Cut Sheet distributed to Securus Project Team	0.5 hrs	Thu 8/18/16	Thu 8/18/16
2533	Complete and certify integration with OMS & Commissary Vendor	1 day	Thu 8/18/16	Fri 8/19/16
2534	Cut-over activities by Dorm/Offender Housing Locations	2 days	Thu 8/18/16	Mon 8/22/16
2535	Quality Control Checkpoint: Customer Acceptance	1.44 days	Mon 8/22/16	Wed 8/24/16
2536	Customer walk through at facility	0.5 hrs	Mon 8/22/16	Mon 8/22/16
2537	Customer review of Quality Control documentation	0.5 hrs	Mon 8/22/16	Mon 8/22/16
2538	Post Cut-over Activities	1.38 days	Mon 8/22/16	Wed 8/24/16
2539	Final installation diagrams (datacom, electrical, and equipment diagrams)	1 hr	Mon 8/22/16	Mon 8/22/16
2540	Site Cutover Preparation Complete - Ready for Training	1 hr	Mon 8/22/16	Mon 8/22/16
2541	Distribute Implementation Customer Satisfaction Survey	1 hr	Tue 8/23/16	Tue 8/23/16
2542	Training	1 day	Tue 8/23/16	Wed 8/24/16
2543	Onsite Customer ITS/WAP Instructor Led Training	1 day	Tue 8/23/16	Wed 8/24/16
2544	Complete and distribute Training Review forms	1 day	Tue 8/23/16	Wed 8/24/16
2545	Customer Acceptance for NY DOC Correctional Facility	1 day	Tue 8/23/16	Wed 8/24/16
2546	WILLARD DRUG TREATMENT CAMPUS	3.75 days	Thu 8/25/16	Wed 8/31/16
2547	Transport Test & Turn-up Activities with Telecom Provider	1 day	Thu 8/25/16	Fri 8/26/16

ID	Task Name	Duration	Start	Finish
2548	Transport turned up with Telecom Provider	1 day	Thu 8/25/16	Fri 8/26/16
2549	Circuit connected to Securus equipment	1 day	Thu 8/25/16	Fri 8/26/16
2550	Installation Support confirmation that Securus equipment on-line	1 day	Thu 8/25/16	Fri 8/26/16
2551	Cut-Over to Securus	2.31 days	Thu 8/25/16	Tue 8/30/16
2552	Re-Verify all Features working properly	0.5 hrs	Thu 8/25/16	Thu 8/25/16
2553	Re-Verify phones work, port assignments/call groups set	0.5 hrs	Thu 8/25/16	Thu 8/25/16
2554	Post Cutover QA Checklist & Test Calls Completed	0.5 hrs	Thu 8/25/16	Thu 8/25/16
2555	Notify Facility ITS/WAP is prepared for cutover and functioning correctly	0.5 hrs	Thu 8/25/16	Thu 8/25/16
2556	Cut Sheet distributed to Securus Project Team	0.5 hrs	Fri 8/26/16	Fri 8/26/16
2557	Complete and certify integration with OMS & Commissary Vendor	1 day	Fri 8/26/16	Mon 8/29/16
2558	Cut-over activities by Dorm/Offender Housing Locations	2 days	Fri 8/26/16	Tue 8/30/16
2559	Quality Control Checkpoint: Customer Acceptance	1.44 days	Tue 8/30/16	Wed 8/31/16
2560	Customer walk through at facility	0.5 hrs	Tue 8/30/16	Tue 8/30/16
2561	Customer review of Quality Control documentation	0.5 hrs	Tue 8/30/16	Tue 8/30/16
2562	Post Cut-over Activities	1.38 days	Tue 8/30/16	Wed 8/31/16
2563	Final installation diagrams (datacom, electrical, and equipment diagrams)	1 hr	Tue 8/30/16	Tue 8/30/16
2564	Site Cutover Preparation Complete - Ready for Training	1 hr	Tue 8/30/16	Tue 8/30/16
2565	Distribute Implementation Customer Satisfaction Survey	1 hr	Tue 8/30/16	Tue 8/30/16
2566	Training	1 day	Tue 8/30/16	Wed 8/31/16
2567	Onsite Customer ITS/WAP Instructor Led Training	1 day	Tue 8/30/16	Wed 8/31/16
2568	Complete and distribute Training Review forms	1 day	Tue 8/30/16	Wed 8/31/16
2569	Customer Acceptance for NY DOC Correctional Facility	1 day	Tue 8/30/16	Wed 8/31/16
2570	MONTEREY SHOCK INCARCERATION CORRECTIONAL FACILITY	3.75 days	Thu 8/25/16	Wed 8/31/16
2571	Transport Test & Turn-up Activities with Telecom Provider	1 day	Thu 8/25/16	Fri 8/26/16
2572	Transport turned up with Telecom Provider	1 day	Thu 8/25/16	Fri 8/26/16
2573	Circuit connected to Securus equipment	1 day	Thu 8/25/16	Fri 8/26/16
2574	Installation Support confirmation that Securus equipment on-line	1 day	Thu 8/25/16	Fri 8/26/16
2575	Cut-Over to Securus	2.31 days	Thu 8/25/16	Tue 8/30/16
2576	Re-Verify all Features working properly	0.5 hrs	Thu 8/25/16	Thu 8/25/16
2577	Re-Verify phones work, port assignments/call groups set	0.5 hrs	Thu 8/25/16	Thu 8/25/16
2578	Post Cutover QA Checklist & Test Calls Completed	0.5 hrs	Thu 8/25/16	Thu 8/25/16
2579	Notify Facility ITS/WAP is prepared for cutover and functioning correctly	0.5 hrs	Thu 8/25/16	Thu 8/25/16
2580	Cut Sheet distributed to Securus Project Team	0.5 hrs	Fri 8/26/16	Fri 8/26/16
2581	Complete and certify integration with OMS & Commissary Vendor	1 day	Fri 8/26/16	Mon 8/29/16
2582	Cut-over activities by Dorm/Offender Housing Locations	2 days	Fri 8/26/16	Tue 8/30/16
2583	Quality Control Checkpoint: Customer Acceptance	1.44 days	Tue 8/30/16	Wed 8/31/16
2584	Customer walk through at facility	0.5 hrs	Tue 8/30/16	Tue 8/30/16

ID	Task Name	Duration	Start	Finish
2585	Customer review of Quality Control documentation	0.5 hrs	Tue 8/30/16	Tue 8/30/16
2586	Post Cut-over Activities	1.38 days	Tue 8/30/16	Wed 8/31/16
2587	Final installation diagrams (datacom, electrical, and equipment diagrams)	1 hr	Tue 8/30/16	Tue 8/30/16
2588	Site Cutover Preparation Complete - Ready for Training	1 hr	Tue 8/30/16	Tue 8/30/16
2589	Distribute Implementation Customer Satisfaction Survey	1 hr	Tue 8/30/16	Tue 8/30/16
2590	Training	1 day	Tue 8/30/16	Wed 8/31/16
2591	Onsite Customer ITS/WAP Instructor Led Training	1 day	Tue 8/30/16	Wed 8/31/16
2592	Complete and distribute Training Review forms	1 day	Tue 8/30/16	Wed 8/31/16
2593	Customer Acceptance for NY DOC Correctional Facility	1 day	Tue 8/30/16	Wed 8/31/16
2594	SOUTHPORT CORRECTIONAL FACILITY	3.75 days	Thu 8/25/16	Wed 8/31/16
2595	Transport Test & Turn-up Activities with Telecom Provider	1 day	Thu 8/25/16	Fri 8/26/16
2596	Transport turned up with Telecom Provider	1 day	Thu 8/25/16	Fri 8/26/16
2597	Circuit connected to Securus equipment	1 day	Thu 8/25/16	Fri 8/26/16
2598	Installation Support confirmation that Securus equipment on-line	1 day	Thu 8/25/16	Fri 8/26/16
2599	Cut-Over to Securus	2.31 days	Thu 8/25/16	Tue 8/30/16
2600	Re-Verify all Features working properly	0.5 hrs	Thu 8/25/16	Thu 8/25/16
2601	Re-Verify phones work, port assignments/call groups set	0.5 hrs	Thu 8/25/16	Thu 8/25/16
2602	Post Cutover QA Checklist & Test Calls Completed	0.5 hrs	Thu 8/25/16	Thu 8/25/16
2603	Notify Facility ITS/WAP is prepared for cutover and functioning correctly	0.5 hrs	Thu 8/25/16	Thu 8/25/16
2604	Cut Sheet distributed to Securus Project Team	0.5 hrs	Fri 8/26/16	Fri 8/26/16
2605	Complete and certify integration with OMS & Commissary Vendor	1 day	Fri 8/26/16	Mon 8/29/16
2606	Cut-over activities by Dorm/Offender Housing Locations	2 days	Fri 8/26/16	Tue 8/30/16
2607	Quality Control Checkpoint: Customer Acceptance	1.44 days	Tue 8/30/16	Wed 8/31/16
2608	Customer walk through at facility	0.5 hrs	Tue 8/30/16	Tue 8/30/16
2609	Customer review of Quality Control documentation	0.5 hrs	Tue 8/30/16	Tue 8/30/16
2610	Post Cut-over Activities	1.38 days	Tue 8/30/16	Wed 8/31/16
2611	Final installation diagrams (datacom, electrical, and equipment diagrams)	1 hr	Tue 8/30/16	Tue 8/30/16
2612	Site Cutover Preparation Complete - Ready for Training	1 hr	Tue 8/30/16	Tue 8/30/16
2613	Distribute Implementation Customer Satisfaction Survey	1 hr	Tue 8/30/16	Tue 8/30/16
2614	Training	1 day	Tue 8/30/16	Wed 8/31/16
2615	Onsite Customer ITS/WAP Instructor Led Training	1 day	Tue 8/30/16	Wed 8/31/16
2616	Complete and distribute Training Review forms	1 day	Tue 8/30/16	Wed 8/31/16
2617	Customer Acceptance for NY DOC Correctional Facility	1 day	Tue 8/30/16	Wed 8/31/16
2618	ELMIRA CORRECTIONAL FACILITY AND RECEPTION CENTER	3.75 days	Thu 8/25/16	Wed 8/31/16
2619	Transport Test & Turn-up Activities with Telecom Provider	1 day	Thu 8/25/16	Fri 8/26/16
2620	Transport turned up with Telecom Provider	1 day	Thu 8/25/16	Fri 8/26/16
2621	Circuit connected to Securus equipment	1 day	Thu 8/25/16	Fri 8/26/16

ID	Task Name	Duration	Start	Finish
2622	Installation Support confirmation that Securus equipment on-line	1 day	Thu 8/25/16	Fri 8/26/16
2623	Cut-Over to Securus	2.31 days	Thu 8/25/16	Tue 8/30/16
2624	Re-Verify all Features working properly	0.5 hrs	Thu 8/25/16	Thu 8/25/16
2625	Re-Verify phones work, port assignments/call groups set	0.5 hrs	Thu 8/25/16	Thu 8/25/16
2626	Post Cutover QA Checklist & Test Calls Completed	0.5 hrs	Thu 8/25/16	Thu 8/25/16
2627	Notify Facility ITS/WAP is prepared for cutover and functioning correctly	0.5 hrs	Thu 8/25/16	Thu 8/25/16
2628	Cut Sheet distributed to Securus Project Team	0.5 hrs	Fri 8/26/16	Fri 8/26/16
2629	Complete and certify integration with OMS & Commissary Vendor	1 day	Fri 8/26/16	Mon 8/29/16
2630	Cut-over activities by Dorm/Offender Housing Locations	2 days	Fri 8/26/16	Tue 8/30/16
2631	Quality Control Checkpoint: Customer Acceptance	1.44 days	Tue 8/30/16	Wed 8/31/16
2632	Customer walk through at facility	0.5 hrs	Tue 8/30/16	Tue 8/30/16
2633	Customer review of Quality Control documentation	0.5 hrs	Tue 8/30/16	Tue 8/30/16
2634	Post Cut-over Activities	1.38 days	Tue 8/30/16	Wed 8/31/16
2635	Final installation diagrams (datacom, electrical, and equipment diagrams)	1 hr	Tue 8/30/16	Tue 8/30/16
2636	Site Cutover Preparation Complete - Ready for Training	1 hr	Tue 8/30/16	Tue 8/30/16
2637	Distribute Implementation Customer Satisfaction Survey	1 hr	Tue 8/30/16	Tue 8/30/16
2638	Training	1 day	Tue 8/30/16	Wed 8/31/16
2639	Onsite Customer ITS/WAP Instructor Led Training	1 day	Tue 8/30/16	Wed 8/31/16
2640	Complete and distribute Training Review forms	1 day	Tue 8/30/16	Wed 8/31/16
2641	Customer Acceptance for NY DOC Correctional Facility	1 day	Tue 8/30/16	Wed 8/31/16
2642	Installation Region 4 Facilities	25.25 days	Wed 7/27/16	Wed 8/31/16
2643	SHAWANGUNK CORRECTIONAL FACILITY	3.75 days	Wed 7/27/16	Mon 8/1/16
2644	Transport Test & Turn-up Activities with Telecom Provider	1 day	Wed 7/27/16	Thu 7/28/16
2645	Transport tur ned up with Telecom Provider	1 day	Wed 7/27/16	Thu 7/28/16
2646	Circuit connected to Securus equipment	1 day	Wed 7/27/16	Thu 7/28/16
2647	Installation Support confirmation that Securus equipment on-line	1 day	Wed 7/27/16	Thu 7/28/16
2648	Cut-Over to Securus	2.31 days	Wed 7/27/16	Fri 7/29/16
2649	Re-Verify all Features working properly	0.5 hrs	Wed 7/27/16	Wed 7/27/16
2650	Re-Verify phones work, port assignments/call groups set	0.5 hrs	Wed 7/27/16	Wed 7/27/16
2651	Post Cutover QA Checklist & Test Calls Completed	0.5 hrs	Wed 7/27/16	Wed 7/27/16
2652	Notify Facility ITS/WAP is prepared for cutover and functioning correctly	0.5 hrs	Wed 7/27/16	Wed 7/27/16
2653	Cut Sheet distributed to Securus Project Team	0.5 hrs	Wed 7/27/16	Wed 7/27/16
2654	Complete and certify integration with OMS & Commissary Vendor	1 day	Wed 7/27/16	Thu 7/28/16
2655	Cut-over activities by Dorm/Offender Housing Locations	2 days	Wed 7/27/16	Fri 7/29/16
2656	Quality Control Checkpoint: Customer Acceptance	1.44 days	Fri 7/29/16	Mon 8/1/16
2657	Customer walk through at facility	0.5 hrs	Fri 7/29/16	Fri 7/29/16
2658	Customer review of Quality Control documentation	0.5 hrs	Fri 7/29/16	Fri 7/29/16

ID	Task Name	Duration	Start	Finish
2659	Post Cut-over Activities	1.38 days	Fri 7/29/16	Mon 8/1/16
2660	Final installation diagrams (datacom, electrical, and equipment diagrams)	1 hr	Fri 7/29/16	Fri 7/29/16
2661	Site Cutover Preparation Complete - Ready for Training	1 hr	Fri 7/29/16	Fri 7/29/16
2662	Distribute Implementation Customer Satisfaction Survey	1 hr	Fri 7/29/16	Fri 7/29/16
2663	Training	1 day	Mon 8/1/16	Mon 8/1/16
2664	Onsite Customer ITS/WAP Instructor Led Training	1 day	Mon 8/1/16	Mon 8/1/16
2665	Complete and distribute Training Review forms	1 day	Mon 8/1/16	Mon 8/1/16
2666	Customer Acceptance for NY DOC Correctional Facility	1 day	Mon 8/1/16	Mon 8/1/16
2667	WALLKILL CORRECTIONAL FACILITY	3.75 days	Wed 7/27/16	Mon 8/1/16
2668	Transport Test & Turn-up Activities with Telecom Provider	1 day	Wed 7/27/16	Thu 7/28/16
2669	Transport turned up with Telecom Provider	1 day	Wed 7/27/16	Thu 7/28/16
2670	Circuit connected to Securus equipment	1 day	Wed 7/27/16	Thu 7/28/16
2671	Installation Support confirmation that Securus equipment on-line	1 day	Wed 7/27/16	Thu 7/28/16
2672	Cut-Over to Securus	2.31 days	Wed 7/27/16	Fri 7/29/16
2673	Re-Verify all Features working properly	0.5 hrs	Wed 7/27/16	Wed 7/27/16
2674	Re-Verify phones work, port assignments/call groups set	0.5 hrs	Wed 7/27/16	Wed 7/27/16
2675	Post Cutover QA Checklist & Test Calls Completed	0.5 hrs	Wed 7/27/16	Wed 7/27/16
2676	Notify Facility ITS/WAP is prepared for cutover and functioning correctly	0.5 hrs	Wed 7/27/16	Wed 7/27/16
2677	Cut Sheet distributed to Securus Project Team	0.5 hrs	Wed 7/27/16	Wed 7/27/16
2678	Complete and certify integration with OMS & Commissary Vendor	1 day	Wed 7/27/16	Thu 7/28/16
2679	Cut-over activities by Dorm/Offender Housing Locations	2 days	Wed 7/27/16	Fri 7/29/16
2680	Quality Control Checkpoint: Customer Acceptance	1.44 days	Fri 7/29/16	Mon 8/1/16
2681	Customer walk through at facility	0.5 hrs	Fri 7/29/16	Fri 7/29/16
2682	Customer review of Quality Control documentation	0.5 hrs	Fri 7/29/16	Fri 7/29/16
2683	Post Cut-over Activities	1.38 days	Fri 7/29/16	Mon 8/1/16
2684	Final installation diagrams (datacom, electrical, and equipment diagrams)	1 hr	Fri 7/29/16	Fri 7/29/16
2685	Site Cutover Preparation Complete - Ready for Training	1 hr	Fri 7/29/16	Fri 7/29/16
2686	Distribute Implementation Customer Satisfaction Survey	1 hr	Fri 7/29/16	Fri 7/29/16
2687	Training	1 day	Mon 8/1/16	Mon 8/1/16
2688	Onsite Customer ITS/WAP Instructor Led Training	1 day	Mon 8/1/16	Mon 8/1/16
2689	Complete and distribute Training Review forms	1 day	Mon 8/1/16	Mon 8/1/16
2690	Customer Acceptance for NY DOC Correctional Facility	1 day	Mon 8/1/16	Mon 8/1/16
2691	OTISVILLE CORRECTIONAL FACILITY	3.75 days	Wed 7/27/16	Mon 8/1/16
2692	Transport Test & Turn-up Activities with Telecom Provider	1 day	Wed 7/27/16	Thu 7/28/16
2693	Transport turned up with Telecom Provider	1 day	Wed 7/27/16	Thu 7/28/16
2694	Circuit connected to Securus equipment	1 day	Wed 7/27/16	Thu 7/28/16
2695	Installation Support confirmation that Securus equipment on-line	1 day	Wed 7/27/16	Thu 7/28/16

ID	Task Name	Duration	Start	Finish
2696	Cut-Over to Securus	2.31 days	Wed 7/27/16	Fri 7/29/16
2697	Re-Verify all Features working properly	0.5 hrs	Wed 7/27/16	Wed 7/27/16
2698	Re-Verify phones work, port assignments/call groups set	0.5 hrs	Wed 7/27/16	Wed 7/27/16
2699	Post Cutover QA Checklist & Test Calls Completed	0.5 hrs	Wed 7/27/16	Wed 7/27/16
2700	Notify Facility ITS/WAP is prepared for cutover and functioning correctly	0.5 hrs	Wed 7/27/16	Wed 7/27/16
2701	Cut Sheet distributed to Securus Project Team	0.5 hrs	Wed 7/27/16	Wed 7/27/16
2702	Complete and certify integration with OMS & Commissary Vendor	1 day	Wed 7/27/16	Thu 7/28/16
2703	Cut-over activities by Dorm/Offender Housing Locations	2 days	Wed 7/27/16	Fri 7/29/16
2704	Quality Control Checkpoint: Customer Acceptance	1.44 days	Fri 7/29/16	Mon 8/1/16
2705	Customer walk through at facility	0.5 hrs	Fri 7/29/16	Fri 7/29/16
2706	Customer review of Quality Control documentation	0.5 hrs	Fri 7/29/16	Fri 7/29/16
2707	Post Cut-over Activities	1.38 days	Fri 7/29/16	Mon 8/1/16
2708	Final installation diagrams (datacom, electrical, and equipment diagrams)	1 hr	Fri 7/29/16	Fri 7/29/16
2709	Site Cutover Preparation Complete - Ready for Training	1 hr	Fri 7/29/16	Fri 7/29/16
2710	Distribute Implementation Customer Satisfaction Survey	1 hr	Fri 7/29/16	Fri 7/29/16
2711	Training	1 day	Mon 8/1/16	Mon 8/1/16
2712	Onsite Customer ITS/WAP Instructor Led Training	1 day	Mon 8/1/16	Mon 8/1/16
2713	Complete and distribute Training Review forms	1 day	Mon 8/1/16	Mon 8/1/16
2714	Customer Acceptance for NY DOC Correctional Facility	1 day	Mon 8/1/16	Mon 8/1/16
2715	FISHKILL CORRECTIONAL FACILITY	3.75 days	Wed 8/3/16	Tue 8/9/16
2716	Transport Test & Turn-up Activities with Telecom Provider	1 day	Wed 8/3/16	Thu 8/4/16
2717	Transport turned up with Telecom Provider	1 day	Wed 8/3/16	Thu 8/4/16
2718	Circuit connected to Securus equipment	1 day	Wed 8/3/16	Thu 8/4/16
2719	Installation Support confirmation that Securus equipment on-line	1 day	Wed 8/3/16	Thu 8/4/16
2720	Cut-Over to Securus	2.31 days	Wed 8/3/16	Fri 8/5/16
2721	Re-Verify all Features working properly	0.5 hrs	Wed 8/3/16	Wed 8/3/16
2722	Re-Verify phones work, port assignments/call groups set	0.5 hrs	Wed 8/3/16	Wed 8/3/16
2723	Post Cutover QA Checklist & Test Calls Completed	0.5 hrs	Wed 8/3/16	Wed 8/3/16
2724	Notify Facility ITS/WAP is prepared for cutover and functioning correctly	0.5 hrs	Wed 8/3/16	Wed 8/3/16
2725	Cut Sheet distributed to Securus Project Team	0.5 hrs	Wed 8/3/16	Wed 8/3/16
2726	Complete and certify integration with OMS & Commissary Vendor	1 day	Wed 8/3/16	Thu 8/4/16
2727	Cut-over activities by Dorm/Offender Housing Locations	2 days	Wed 8/3/16	Fri 8/5/16
2728	Quality Control Checkpoint: Customer Acceptance	1.44 days	Fri 8/5/16	Tue 8/9/16
2729	Customer walk through at facility	0.5 hrs	Fri 8/5/16	Fri 8/5/16
2730	Customer review of Quality Control documentation	0.5 hrs	Fri 8/5/16	Fri 8/5/16
2731	Post Cut-over Activities	1.38 days	Mon 8/8/16	Tue 8/9/16
2732	Final installation diagrams (datacom, electrical, and equipment diagrams)	1 hr	Mon 8/8/16	Mon 8/8/16

ID	Task Name	Duration	Start	Finish
2733	Site Cutover Preparation Complete - Ready for Training	1 hr	Mon 8/8/16	Mon 8/8/16
2734	Distribute Implementation Customer Satisfaction Survey	1 hr	Mon 8/8/16	Mon 8/8/16
2735	Training	1 day	Mon 8/8/16	Tue 8/9/16
2736	Onsite Customer ITS/WAP Instructor Led Training	1 day	Mon 8/8/16	Tue 8/9/16
2737	Complete and distribute Training Review forms	1 day	Mon 8/8/16	Tue 8/9/16
2738	Customer Acceptance for NY DOC Correctional Facility	1 day	Mon 8/8/16	Tue 8/9/16
2739	BEACON CORRECTIONAL FACILITY	3.75 days	Wed 8/3/16	Tue 8/9/16
2740	Transport Test & Turn-up Activities with Telecom Provider	1 day	Wed 8/3/16	Thu 8/4/16
2741	Transport turned up with Telecom Provider	1 day	Wed 8/3/16	Thu 8/4/16
2742	Circuit connected to Securus equipment	1 day	Wed 8/3/16	Thu 8/4/16
2743	Installation Support confirmation that Securus equipment on-line	1 day	Wed 8/3/16	Thu 8/4/16
2744	Cut-Over to Securus	2.31 days	Wed 8/3/16	Fri 8/5/16
2745	Re-Verify all Features working properly	0.5 hrs	Wed 8/3/16	Wed 8/3/16
2746	Re-Verify phones work, port assignments/call groups set	0.5 hrs	Wed 8/3/16	Wed 8/3/16
2747	Post Cutover QA Checklist & Test Calls Completed	0.5 hrs	Wed 8/3/16	Wed 8/3/16
2748	Notify Facility ITS/WAP is prepared for cutover and functioning correctly	0.5 hrs	Wed 8/3/16	Wed 8/3/16
2749	Cut Sheet distributed to Securus Project Team	0.5 hrs	Wed 8/3/16	Wed 8/3/16
2750	Complete and certify integration with OMS & Commissary Vendor	1 day	Wed 8/3/16	Thu 8/4/16
2751	Cut-over activities by Dorm/Offender Housing Locations	2 days	Wed 8/3/16	Fri 8/5/16
2752	Quality Control Checkpoint: Customer Acceptance	1.44 days	Fri 8/5/16	Tue 8/9/16
2753	Customer walk through at facility	0.5 hrs	Fri 8/5/16	Fri 8/5/16
2754	Customer review of Quality Control documentation	0.5 hrs	Fri 8/5/16	Fri 8/5/16
2755	Post Cut-over Activities	1.38 days	Mon 8/8/16	Tue 8/9/16
2756	Final installation diagrams (datacom, electrical, and equipment diagrams)	1 hr	Mon 8/8/16	Mon 8/8/16
2757	Site Cutover Preparation Complete - Ready for Training	1 hr	Mon 8/8/16	Mon 8/8/16
2758	Distribute Implementation Customer Satisfaction Survey	1 hr	Mon 8/8/16	Mon 8/8/16
2759	Training	1 day	Mon 8/8/16	Tue 8/9/16
2760	Onsite Customer ITS/WAP Instructor Led Training	1 day	Mon 8/8/16	Tue 8/9/16
2761	Complete and distribute Training Review forms	1 day	Mon 8/8/16	Tue 8/9/16
2762	Customer Acceptance for NY DOC Correctional Facility	1 day	Mon 8/8/16	Tue 8/9/16
2763	DOWNSTATE CORRECTIONAL FACILITY	3.75 days	Wed 8/3/16	Tue 8/9/16
2764	Transport Test & Turn-up Activities with Telecom Provider	1 day	Wed 8/3/16	Thu 8/4/16
2765	Transport turned up with Telecom Provider	1 day	Wed 8/3/16	Thu 8/4/16
2766	Circuit connected to Securus equipment	1 day	Wed 8/3/16	Thu 8/4/16
2767	Installation Support confirmation that Securus equipment on-line	1 day	Wed 8/3/16	Thu 8/4/16
2768	Cut-Over to Securus	2.31 days	Wed 8/3/16	Fri 8/5/16
2769	Re-Verify all Features working properly	0.5 hrs	Wed 8/3/16	Wed 8/3/16

ID	Task Name	Duration	Start	Finish
2770	Re-Verify phones work, port assignments/call groups set	0.5 hrs	Wed 8/3/16	Wed 8/3/16
2771	Post Cutover QA Checklist & Test Calls Completed	0.5 hrs	Wed 8/3/16	Wed 8/3/16
2772	Notify Facility ITS/WAP is prepared for cutover and functioning correctly	0.5 hrs	Wed 8/3/16	Wed 8/3/16
2773	Cut Sheet distributed to Securus Project Team	0.5 hrs	Wed 8/3/16	Wed 8/3/16
2774	Complete and certify integration with OMS & Commissary Vendor	1 day	Wed 8/3/16	Thu 8/4/16
2775	Cut-over activities by Dorm/Offender Housing Locations	2 days	Wed 8/3/16	Fri 8/5/16
2776	Quality Control Checkpoint: Customer Acceptance	1.44 days	Fri 8/5/16	Tue 8/9/16
2777	Customer walk through at facility	0.5 hrs	Fri 8/5/16	Fri 8/5/16
2778	Customer review of Quality Control documentation	0.5 hrs	Fri 8/5/16	Fri 8/5/16
2779	Post Cut-over Activities	1.38 days	Mon 8/8/16	Tue 8/9/16
2780	Final installation diagrams (datacom, electrical, and equipment diagrams)	1 hr	Mon 8/8/16	Mon 8/8/16
2781	Site Cutover Preparation Complete - Ready for Training	1 hr	Mon 8/8/16	Mon 8/8/16
2782	Distribute Implementation Customer Satisfaction Survey	1 hr	Mon 8/8/16	Mon 8/8/16
2783	Training	1 day	Mon 8/8/16	Tue 8/9/16
2784	Onsite Customer ITS/WAP Instructor Led Training	1 day	Mon 8/8/16	Tue 8/9/16
2785	Complete and distribute Training Review forms	1 day	Mon 8/8/16	Tue 8/9/16
2786	Customer Acceptance for NY DOC Correctional Facility	1 day	Mon 8/8/16	Tue 8/9/16
2787	GREEN HAVEN CORRECTIONAL FACILITY	3.75 days	Thu 8/11/16	Tue 8/16/16
2788	Transport Test & Turn-up Activities with Telecom Provider	1 day	Thu 8/11/16	Thu 8/11/16
2789	Transport turned up with Telecom Provider	1 day	Thu 8/11/16	Thu 8/11/16
2790	Circuit connected to Securus equipment	1 day	Thu 8/11/16	Thu 8/11/16
2791	Installation Support confirmation that Securus equipment on-line	1 day	Thu 8/11/16	Thu 8/11/16
2792	Cut-Over to Securus	2.31 days	Thu 8/11/16	Mon 8/15/16
2793	Re-Verify all Features working properly	0.5 hrs	Thu 8/11/16	Thu 8/11/16
2794	Re-Verify phones work, port assignments/call groups set	0.5 hrs	Thu 8/11/16	Thu 8/11/16
2795	Post Cutover QA Checklist & Test Calls Completed	0.5 hrs	Thu 8/11/16	Thu 8/11/16
2796	Notify Facility ITS/WAP is prepared for cutover and functioning correctly	0.5 hrs	Thu 8/11/16	Thu 8/11/16
2797	Cut Sheet distributed to Securus Project Team	0.5 hrs	Thu 8/11/16	Thu 8/11/16
2798	Complete and certify integration with OMS & Commissary Vendor	1 day	Thu 8/11/16	Fri 8/12/16
2799	Cut-over activities by Dorm/Offender Housing Locations	2 days	Thu 8/11/16	Mon 8/15/16
2800	Quality Control Checkpoint: Customer Acceptance	1.44 days	Mon 8/15/16	Tue 8/16/16
2801	Customer walk through at facility	0.5 hrs	Mon 8/15/16	Mon 8/15/16
2802	Customer review of Quality Control documentation	0.5 hrs	Mon 8/15/16	Mon 8/15/16
2803	Post Cut-over Activities	1.38 days	Mon 8/15/16	Tue 8/16/16
2804	Final installation diagrams (datacom, electrical, and equipment diagrams)	1 hr	Mon 8/15/16	Mon 8/15/16
2805	Site Cutover Preparation Complete - Ready for Training	1 hr	Mon 8/15/16	Mon 8/15/16
2806	Distribute Implementation Customer Satisfaction Survey	1 hr	Mon 8/15/16	Mon 8/15/16

ID	Task Name	Duration	Start	Finish
2807	Training	1 day	Mon 8/15/16	Tue 8/16/16
2808	Onsite Customer ITS/WAP Instructor Led Training	1 day	Mon 8/15/16	Tue 8/16/16
2809	Complete and distribute Training Review forms	1 day	Mon 8/15/16	Tue 8/16/16
2810	Customer Acceptance for NY DOC Correctional Facility	1 day	Mon 8/15/16	Tue 8/16/16
2811	TACONIC CORRECTIONAL FACILITY	3.75 days	Thu 8/11/16	Tue 8/16/16
2812	Transport Test & Turn-up Activities with Telecom Provider	1 day	Thu 8/11/16	Thu 8/11/16
2813	Transport turned up with Telecom Provider	1 day	Thu 8/11/16	Thu 8/11/16
2814	Circuit connected to Securus equipment	1 day	Thu 8/11/16	Thu 8/11/16
2815	Installation Support confirmation that Securus equipment on-line	1 day	Thu 8/11/16	Thu 8/11/16
2816	Cut-Over to Securus	2.31 days	Thu 8/11/16	Mon 8/15/16
2817	Re-Verify all Features working properly	0.5 hrs	Thu 8/11/16	Thu 8/11/16
2818	Re-Verify phones work, port assignments/call groups set	0.5 hrs	Thu 8/11/16	Thu 8/11/16
2819	Post Cutover QA Checklist & Test Calls Completed	0.5 hrs	Thu 8/11/16	Thu 8/11/16
2820	Notify Facility ITS/WAP is prepared for cutover and functioning correctly	0.5 hrs	Thu 8/11/16	Thu 8/11/16
2821	Cut Sheet distributed to Securus Project Team	0.5 hrs	Thu 8/11/16	Thu 8/11/16
2822	Complete and certify integration with OMS & Commissary Vendor	1 day	Thu 8/11/16	Fri 8/12/16
2823	Cut-over activities by Dorm/Offender Housing Locations	2 days	Thu 8/11/16	Mon 8/15/16
2824	Quality Control Checkpoint: Customer Acceptance	1.44 days	Mon 8/15/16	Tue 8/16/16
2825	Customer walk through at facility	0.5 hrs	Mon 8/15/16	Mon 8/15/16
2826	Customer review of Quality Control documentation	0.5 hrs	Mon 8/15/16	Mon 8/15/16
2827	Post Cut-over Activities	1.38 days	Mon 8/15/16	Tue 8/16/16
2828	Final installation diagrams (datacom, electrical, and equipment diagrams)	1 hr	Mon 8/15/16	Mon 8/15/16
2829	Site Cutover Preparation Complete - Ready for Training	1 hr	Mon 8/15/16	Mon 8/15/16
2830	Distribute Implementation Customer Satisfaction Survey	1 hr	Mon 8/15/16	Mon 8/15/16
2831	Training	1 day	Mon 8/15/16	Tue 8/16/16
2832	Onsite Customer ITS/WAP Instructor Led Training	1 day	Mon 8/15/16	Tue 8/16/16
2833	Complete and distribute Training Review forms	1 day	Mon 8/15/16	Tue 8/16/16
2834	Customer Acceptance for NY DOC Correctional Facility	1 day	Mon 8/15/16	Tue 8/16/16
2835	BEDFORD HILLS CORRECTIONAL FACILITY	3.75 days	Thu 8/11/16	Tue 8/16/16
2836	Transport Test & Turn-up Activities with Telecom Provider	1 day	Thu 8/11/16	Thu 8/11/16
2837	Transport turned up with Telecom Provider	1 day	Thu 8/11/16	Thu 8/11/16
2838	Circuit connected to Securus equipment	1 day	Thu 8/11/16	Thu 8/11/16
2839	Installation Support confirmation that Securus equipment on-line	1 day	Thu 8/11/16	Thu 8/11/16
2840	Cut-Over to Securus	2.31 days	Thu 8/11/16	Mon 8/15/16
2841	Re-Verify all Features working properly	0.5 hrs	Thu 8/11/16	Thu 8/11/16
2842	Re-Verify phones work, port assignments/call groups set	0.5 hrs	Thu 8/11/16	Thu 8/11/16
2843	Post Cutover QA Checklist & Test Calls Completed	0.5 hrs	Thu 8/11/16	Thu 8/11/16

ID	Task Name	Duration	Start	Finish
2844	Notify Facility ITS/WAP is prepared for cutover and functioning correctly	0.5 hrs	Thu 8/11/16	Thu 8/11/16
2845	Cut Sheet distributed to Securus Project Team	0.5 hrs	Thu 8/11/16	Thu 8/11/16
2846	Complete and certify integration with OMS & Commissary Vendor	1 day	Thu 8/11/16	Fri 8/12/16
2847	Cutover activities by Dorm/Offender Housing Locations	2 days	Thu 8/11/16	Mon 8/15/16
2848	Quality Control Checkpoint: Customer Acceptance	1.44 days	Mon 8/15/16	Tue 8/16/16
2849	Customer walk through at facility	0.5 hrs	Mon 8/15/16	Mon 8/15/16
2850	Customer review of Quality Control documentation	0.5 hrs	Mon 8/15/16	Mon 8/15/16
2851	Post Cut-over Activities	1.38 days	Mon 8/15/16	Tue 8/16/16
2852	Final installation diagrams (datacom, electrical, and equipment diagrams)	1 hr	Mon 8/15/16	Mon 8/15/16
2853	Site Cutover Preparation Complete - Ready for Training	1 hr	Mon 8/15/16	Mon 8/15/16
2854	Distribute Implementation Customer Satisfaction Survey	1 hr	Mon 8/15/16	Mon 8/15/16
2855	Training	1 day	Mon 8/15/16	Tue 8/16/16
2856	Onsite Customer ITS/WAP Instructor Led Training	1 day	Mon 8/15/16	Tue 8/16/16
2857	Complete and distribute Training Review forms	1 day	Mon 8/15/16	Tue 8/16/16
2858	Customer Acceptance for NY DOC Correctional Facility	1 day	Mon 8/15/16	Tue 8/16/16
2859	SING SING CORRECTIONAL FACILITY	3.75 days	Thu 8/18/16	Wed 8/24/16
2860	Transport Test & Turn-up Activities with Telecom Provider	1 day	Thu 8/18/16	Fri 8/19/16
2861	Transport turned up with Telecom Provider	1 day	Thu 8/18/16	Fri 8/19/16
2862	Circuit connected to Securus equipment	1 day	Thu 8/18/16	Fri 8/19/16
2863	Installation Support confirmation that Securus equipment on-line	1 day	Thu 8/18/16	Fri 8/19/16
2864	Cut-Over to Securus	2.31 days	Thu 8/18/16	Mon 8/22/16
2865	Re-Verify all Features working properly	0.5 hrs	Thu 8/18/16	Thu 8/18/16
2866	Re-Verify phones work, port assignments/call groups set	0.5 hrs	Thu 8/18/16	Thu 8/18/16
2867	Post Cutover QA Checklist & Test Calls Completed	0.5 hrs	Thu 8/18/16	Thu 8/18/16
2868	Notify Facility ITS/WAP is prepared for cutover and functioning correctly	0.5 hrs	Thu 8/18/16	Thu 8/18/16
2869	Cut Sheet distributed to Securus Project Team	0.5 hrs	Thu 8/18/16	Thu 8/18/16
2870	Complete and certify integration with OMS & Commissary Vendor	1 day	Thu 8/18/16	Fri 8/19/16
2871	Cutover activities by Dorm/Offender Housing Locations	2 days	Thu 8/18/16	Mon 8/22/16
2872	Quality Control Checkpoint: Customer Acceptance	1.44 days	Mon 8/22/16	Wed 8/24/16
2873	Customer walk through at facility	0.5 hrs	Mon 8/22/16	Mon 8/22/16
2874	Customer review of Quality Control documentation	0.5 hrs	Mon 8/22/16	Mon 8/22/16
2875	Post Cut-over Activities	1.38 days	Mon 8/22/16	Wed 8/24/16
2876	Final installation diagrams (datacom, electrical, and equipment diagrams)	1 hr	Mon 8/22/16	Mon 8/22/16
2877	Site Cutover Preparation Complete - Ready for Training	1 hr	Mon 8/22/16	Mon 8/22/16
2878	Distribute Implementation Customer Satisfaction Survey	1 hr	Tue 8/23/16	Tue 8/23/16
2879	Training	1 day	Tue 8/23/16	Wed 8/24/16
2880	Onsite Customer ITS/WAP Instructor Led Training	1 day	Tue 8/23/16	Wed 8/24/16

ID	Task Name	Duration	Start	Finish
2881	Complete and distribute Training Review forms	1 day	Tue 8/23/16	Wed 8/24/16
2882	Customer Acceptance for NY DOC Correctional Facility	1 day	Tue 8/23/16	Wed 8/24/16
2883	EDGEcombe RESIDENTIAL TREATMENT FACILITY	3.75 days	Thu 8/18/16	Wed 8/24/16
2884	Transport Test & Turn-up Activities with Telecom Provider	1 day	Thu 8/18/16	Fri 8/19/16
2885	Transport turned up with Telecom Provider	1 day	Thu 8/18/16	Fri 8/19/16
2886	Circuit connected to Securus equipment	1 day	Thu 8/18/16	Fri 8/19/16
2887	Installation Support confirmation that Securus equipment on-line	1 day	Thu 8/18/16	Fri 8/19/16
2888	Cut-Over to Securus	2.31 days	Thu 8/18/16	Mon 8/22/16
2889	Re-Verify all Features working properly	0.5 hrs	Thu 8/18/16	Thu 8/18/16
2890	Re-Verify phones work, port assignments/call groups set	0.5 hrs	Thu 8/18/16	Thu 8/18/16
2891	Post Cutover QA Checklist & Test Calls Completed	0.5 hrs	Thu 8/18/16	Thu 8/18/16
2892	Notify Facility ITS/WAP is prepared for cutover and functioning correctly	0.5 hrs	Thu 8/18/16	Thu 8/18/16
2893	Cut Sheet distributed to Securus Project Team	0.5 hrs	Thu 8/18/16	Thu 8/18/16
2894	Complete and certify integration with OMS & Commissary Vendor	1 day	Thu 8/18/16	Fri 8/19/16
2895	Cut-over activities by Dorm/Offender Housing Locations	2 days	Thu 8/18/16	Mon 8/22/16
2896	Quality Control Checkpoint: Customer Acceptance	1.44 days	Mon 8/22/16	Wed 8/24/16
2897	Customer walk through at facility	0.5 hrs	Mon 8/22/16	Mon 8/22/16
2898	Customer review of Quality Control documentation	0.5 hrs	Mon 8/22/16	Mon 8/22/16
2899	Post Cut-over Activities	1.38 days	Mon 8/22/16	Wed 8/24/16
2900	Final installation diagrams (datacom, electrical, and equipment diagrams)	1 hr	Mon 8/22/16	Mon 8/22/16
2901	Site Cutover Preparation Complete - Ready for Training	1 hr	Mon 8/22/16	Mon 8/22/16
2902	Distribute Implementation Customer Satisfaction Survey	1 hr	Tue 8/23/16	Tue 8/23/16
2903	Training	1 day	Tue 8/23/16	Wed 8/24/16
2904	Onsite Customer ITS/WAP Instructor Led Training	1 day	Tue 8/23/16	Wed 8/24/16
2905	Complete and distribute Training Review forms	1 day	Tue 8/23/16	Wed 8/24/16
2906	Customer Acceptance for NY DOC Correctional Facility	1 day	Tue 8/23/16	Wed 8/24/16
2907	BAYVIEW CORRECTIONAL FACILITY	3.75 days	Tue 8/23/16	Wed 8/24/16
2908	Transport Test & Turn-up Activities with Telecom Provider	1 day	Thu 8/18/16	Fri 8/19/16
2909	Transport turned up with Telecom Provider	1 day	Thu 8/18/16	Fri 8/19/16
2910	Circuit connected to Securus equipment	1 day	Thu 8/18/16	Fri 8/19/16
2911	Installation Support confirmation that Securus equipment on-line	1 day	Thu 8/18/16	Fri 8/19/16
2912	Cut-Over to Securus	2.31 days	Thu 8/18/16	Mon 8/22/16
2913	Re-Verify all Features working properly	0.5 hrs	Thu 8/18/16	Thu 8/18/16
2914	Re-Verify phones work, port assignments/call groups set	0.5 hrs	Thu 8/18/16	Thu 8/18/16
2915	Post Cutover QA Checklist & Test Calls Completed	0.5 hrs	Thu 8/18/16	Thu 8/18/16
2916	Notify Facility ITS/WAP is prepared for cutover and functioning correctly	0.5 hrs	Thu 8/18/16	Thu 8/18/16
2917	Cut Sheet distributed to Securus Project Team	0.5 hrs	Thu 8/18/16	Thu 8/18/16

ID	Task Name	Duration	Start	Finish
2918	Complete and certify integration with OMS & Commissary Vendor	1 day	Thu 8/18/16	Fri 8/19/16
2919	Cut-over activities by Dorm/Offender Housing Locations	2 days	Thu 8/18/16	Mon 8/22/16
2920	Quality Control Checkpoint: Customer Acceptance	1.44 days	Mon 8/22/16	Wed 8/24/16
2921	Customer walk through at facility	0.5 hrs	Mon 8/22/16	Mon 8/22/16
2922	Customer review of Quality Control documentation	0.5 hrs	Mon 8/22/16	Mon 8/22/16
2923	Post Cut-over Activities	1.38 days	Mon 8/22/16	Wed 8/24/16
2924	Final installation diagrams (datacom, electrical, and equipment diagrams)	1 hr	Mon 8/22/16	Mon 8/22/16
2925	Site Cutover Preparation Complete - Ready for Training	1 hr	Mon 8/22/16	Mon 8/22/16
2926	Distribute Implementation Customer Satisfaction Survey	1 hr	Tue 8/23/16	Tue 8/23/16
2927	Training	1 day	Tue 8/23/16	Wed 8/24/16
2928	Onsite Customer ITS/WAP Instructor Led Training	1 day	Tue 8/23/16	Wed 8/24/16
2929	Complete and distribute Training Review forms	1 day	Tue 8/23/16	Wed 8/24/16
2930	Customer Acceptance for NY DOC Correctional Facility	1 day	Tue 8/23/16	Wed 8/24/16
2931	LINCOLN CORRECTIONAL FACILITY	3.75 days	Thu 8/25/16	Wed 8/31/16
2932	Transport Test & Turn-up Activities with Telecom Provider	1 day	Thu 8/25/16	Fri 8/26/16
2933	Transport turned up with Telecom Provider	1 day	Thu 8/25/16	Fri 8/26/16
2934	Circuit connected to Securus equipment	1 day	Thu 8/25/16	Fri 8/26/16
2935	Installation Support confirmation that Securus equipment on-line	1 day	Thu 8/25/16	Fri 8/26/16
2936	Cut-Over to Securus	2.31 days	Thu 8/25/16	Tue 8/30/16
2937	Re-Verify all Features working properly	0.5 hrs	Thu 8/25/16	Thu 8/25/16
2938	Re-Verify phones work, port assignments/call groups set	0.5 hrs	Thu 8/25/16	Thu 8/25/16
2939	Post Cutover QA Checklist & Test Calls Completed	0.5 hrs	Thu 8/25/16	Thu 8/25/16
2940	Notify Facility ITS/WAP is prepared for cutover and functioning correctly	0.5 hrs	Thu 8/25/16	Thu 8/25/16
2941	Cut Sheet distributed to Securus Project Team	0.5 hrs	Fri 8/26/16	Fri 8/26/16
2942	Complete and certify integration with OMS & Commissary Vendor	1 day	Fri 8/26/16	Mon 8/29/16
2943	Cut-over activities by Dorm/Offender Housing Locations	2 days	Fri 8/26/16	Tue 8/30/16
2944	Quality Control Checkpoint: Customer Acceptance	1.44 days	Tue 8/30/16	Wed 8/31/16
2945	Customer walk through at facility	0.5 hrs	Tue 8/30/16	Tue 8/30/16
2946	Customer review of Quality Control documentation	0.5 hrs	Tue 8/30/16	Tue 8/30/16
2947	Post Cut-over Activities	1.38 days	Tue 8/30/16	Wed 8/31/16
2948	Final installation diagrams (datacom, electrical, and equipment diagrams)	1 hr	Tue 8/30/16	Tue 8/30/16
2949	Site Cutover Preparation Complete - Ready for Training	1 hr	Tue 8/30/16	Tue 8/30/16
2950	Distribute Implementation Customer Satisfaction Survey	1 hr	Tue 8/30/16	Tue 8/30/16
2951	Training	1 day	Tue 8/30/16	Wed 8/31/16
2952	Onsite Customer ITS/WAP Instructor Led Training	1 day	Tue 8/30/16	Wed 8/31/16
2953	Complete and distribute Training Review forms	1 day	Tue 8/30/16	Wed 8/31/16
2954	Customer Acceptance for NY DOC Correctional Facility	1 day	Tue 8/30/16	Wed 8/31/16

ID	Task Name	Duration	Start	Finish
2955	QUEENSBORO CORRECTIONAL FACILITY	3.75 days	Thu 8/25/16	Wed 8/31/16
2956	Transport Test & Turn-up Activities with Telecom Provider	1 day	Thu 8/25/16	Fri 8/26/16
2957	Transport tur ned up with Telecom Provider	1 day	Thu 8/25/16	Fri 8/26/16
2958	Circuit connected to Securus equipment	1 day	Thu 8/25/16	Fri 8/26/16
2959	Installation Support confirmation that Securus equipment on-line	1 day	Thu 8/25/16	Fri 8/26/16
2960	Cut-Over to Securus	2.31 days	Thu 8/25/16	Tue 8/30/16
2961	Re-Verify all Features working properly	0.5 hrs	Thu 8/25/16	Thu 8/25/16
2962	Re-Verify phones work, port assignments/call groups set	0.5 hrs	Thu 8/25/16	Thu 8/25/16
2963	Post Cutover QA Checklist & Test Calls Completed	0.5 hrs	Thu 8/25/16	Thu 8/25/16
2964	Notify Facility ITS/WAP is prepared for cutover and functioning correctly	0.5 hrs	Thu 8/25/16	Thu 8/25/16
2965	Cut Sheet distributed to Securus Project Team	0.5 hrs	Thu 8/26/16	Fri 8/26/16
2966	Complete and certify integration with OMS & Commissary Vendor	1 day	Fri 8/26/16	Mon 8/29/16
2967	Cut-over activities by Dorm/Offender Housing Locations	2 days	Fri 8/26/16	Tue 8/30/16
2968	Quality Control Checkpoint: Customer Acceptance	1.44 days	Tue 8/30/16	Wed 8/31/16
2969	Customer walk through at facility	0.5 hrs	Tue 8/30/16	Tue 8/30/16
2970	Customer review of Quality Control documentation	0.5 hrs	Tue 8/30/16	Tue 8/30/16
2971	Post Cut-over Activities	1.38 days	Tue 8/30/16	Wed 8/31/16
2972	Final installation diagrams (datacom, electrical, and equipment diagrams)	1 hr	Tue 8/30/16	Tue 8/30/16
2973	Site Cutover Preparation Complete - Ready for Training	1 hr	Tue 8/30/16	Tue 8/30/16
2974	Distribute Implementation Customer Satisfaction Survey	1 hr	Tue 8/30/16	Tue 8/30/16
2975	Training	1 day	Tue 8/30/16	Wed 8/31/16
2976	Onsite Customer ITS/WAP Instructor Led Training	1 day	Tue 8/30/16	Wed 8/31/16
2977	Complete and distribute Training Review forms	1 day	Tue 8/30/16	Wed 8/31/16
2978	Customer Acceptance for NY DOC Correctional Facility	1 day	Tue 8/30/16	Wed 8/31/16

Migration Plan

ID	Task Name	Duration	Start	Finish
1	Securus Data Integration and Migration plan for New York Department of Corrections project plan	42 days	Mon 4/3/17	Tue 5/30/17
2	Planning Phase	15 days	Mon 4/3/17	Fri 4/21/17
3	IC/INT - Validate requirements/gather current integration details and products (see procedure)	4 days	Mon 4/3/17	Thu 4/6/17
4	Attend PM Internal Call - have notes prepared	2 days	Fri 4/7/17	Mon 4/10/17
5	Attend Customer Call or Integration Call - have notes prepared	2 days	Tue 4/11/17	Wed 4/12/17
6	INT - VPN if required - begin process - send form to POC/IT, assign ticket to NOC, request IP's	1 day	Thu 4/13/17	Thu 4/13/17
7	IC/INT - Request WebService Credentials and/or create E-imports credentials and send credentials to vendor/county	1 day	Fri 4/14/17	Fri 4/14/17
8	IC - Create a Message in the Integration Tab called "config specs" detailing configuration requirements the tech will need for the project. See desk procedure for configuration options to	2 days	Thu 4/20/17	Fri 4/21/17
9	Execution Phase	10 days	Mon 4/24/17	Fri 5/5/17
10	IC - Create dialing instructions and Integration Document and send to PM	4 days	Mon 4/24/17	Thu 4/27/17
11	INT - SW - Code Integration Solution	10 days	Mon 4/24/17	Fri 5/5/17
12	INT - Code Debit requirements in Account Prefix Configuration Utility (see Message in Integration portal for site specifics)	10 days	Mon 4/24/17	Fri 5/5/17
13	INT - COBP - create requested speed dial, make test call to confirm you can reach the vendor IVR	2 days	Mon 4/24/17	Tue 4/25/17
14	IC - confirm go live date with vendor and PM, update Target Date in portal	1 day	Wed 4/26/17	Wed 4/26/17
15	Controlling & Monitoring Phase	20 days	Thu 4/27/17	Wed 5/24/17
16	IPRO projects - 1 week prior to enrollments, confirm data in SCP includes housing (when available) and confirm active inmate count matches the current population or JMS count	12 days	Thu 4/27/17	Fri 5/12/17
17	VPN - Securus and Customer successful connection	12 days	Thu 4/27/17	Fri 5/12/17
18	IC - confirm debit rates are loaded	5 days	Mon 5/15/17	Fri 5/19/17
19	PINs - for E-imports, obtain data 1-2 weeks prior to go live, confirm correct PIN format & inmate count is accurate and if vendor change, confirm duplicate accounts were not created	7 days	Mon 5/15/17	Tue 5/23/17
20	All - communicate completion of your pre-install tasks to the PM, IST, and Vendors 2-3 days prior to the scheduled go live date	1 day	Wed 5/24/17	Wed 5/24/17
21	Closing Phase	4 days	Thu 5/25/17	Tue 5/30/17
22	INT - WebService PINS - disable any SVV or other feeds as needed until all accounts are loaded, confirm no duplicate, confirm pin format, validate accounts in SCP	2 days	Thu 5/25/17	Fri 5/26/17
23	INT - Adding or Changing PINS - Validate the correct PIN min/max on all MPGs	2 days	Thu 5/25/17	Fri 5/26/17
24	IC - send new PIN list to PM	2 days	Mon 5/29/17	Tue 5/30/17
25	INT - Provision Debit Calling/move TPS calling if applicable	2 days	Mon 5/29/17	Tue 5/30/17
26	INT - Debit - Confirm a successful TEST payment and refund via integration method (if obtainable from vendor)	1 day	Mon 5/29/17	Mon 5/29/17

ID	Task Name	Duration	Start	Finish
27	IC/INT - Confirm successful inmate debit payments in SCP	1 day	Mon 5/29/17	Mon 5/29/17
28	IC/INT - Confirm successful I/m debit refund(s) are processing as intended (see procedures)	1 day	Mon 5/29/17	Mon 5/29/17
29	IC - Confirm inmates are able to make successful COBP and debit calls (and prepaid card calls if applk)	1 day	Mon 5/29/17	Mon 5/29/17
30	INT - SCP Prompts for Inmate Debit (1) Enable 30 day marketing prompts (2) enable or disable Western Union prompts as required based on refund method	1 day	Mon 5/29/17	Mon 5/29/17
31	INT - confirm E-imports refunding is Unchecked in provisioning if Automated Check refunds is enable	1 day	Mon 5/29/17	Mon 5/29/17
32	INT - SW - confirm housing is accurate in data file, confirm inmate matches JMS; move/confirm inmates are in unspecified, make sure housing changes are being received/processed	1 day	Mon 5/29/17	Mon 5/29/17
33	INT - VG - code solution to match phone groups, confirm data/all inmates have an assigned group/all groups are coded	1 day	Mon 5/29/17	Mon 5/29/17
34	Resolve your Heat assignment after integration completed	1 day	Tue 5/30/17	Tue 5/30/17

Fallback Plan

Acceptance Test of Integration	
W e b S e r v i c e s	"Create Account" on SCN/or "NewAcct Trans" on Unisys
	"Apply Payment" SCN/DLT /or "Prepaid Funding Trans" on Unisys /or "Credit"
	If "Automated Check" - Release Account on SCN/DLT / or "Credit On Release on Unisys" transactions processing, ALL: confirm at least one has a balance over 0.00
	Acct Auth, Order item, Apply Payment (DLT)
	NO Backouts on Trust / if found, validate reason w/ Vendor
	Location Update (SCN/ Unisys) - continued updated after go-live
	pin updates successful
S C P U I	# of Active Custody Accounts in SCP is equal to vendor count or complete file - validate SCP is not growing at go-live and at 7 days
	Check Custody Account Change logs - confirm no manual pin changes being entered unless retain pin enabled, if found, notify PM
	If retain SCP pin was requested, confirm pins don't change in SCP UI when FTP files are processed
	Recycle Pin (recommend w/debit) confirm "no pin" on inactive accounts
	1st Call Free (FCF) calls processing (for new and rebooked inmates)
	COBP - inmate calls are successful (not just completed)
	Debit Call Type 2 - successful
	If using Trust, Call Type 3 is successful
	If still using PPCC, Prepaid Card calls are attempted (do not have to complete, just attempted to show it is still enabled)
F T P	Eimports/ PETL - confirm complete file is 10% larger than min. set (or set a min record count if needed)
	If Instant Refunds - confirm we are not processing complete or release files
S V V	SVV - confirm complete file is 10% larger than min. set
	Movements are successful
V G	No errors, groups are being populated
P r o v i s i o n i n g	For Automated Check refunds - confirm E-imports Debit Refund box is unchecked - ALSO CONFIRM THAT REFUNDS ARE PROCESSING IN WEBSERVICE**
	Confirm Western Union prompts do NOT play if the sites does not use Western Union

SW 7 Day Install Monitoring	
Site Info	
Site ID	
Site Name	
Installer	
Cut Date	
Cable	
Bonded	
Adtran Count	
Adtran Type	
Station Count	
Business Day 1	<i>Within Parameters</i>
1st 24hr Recordings	
Packet Loss	
Onsite Visits (Qty)	
Remote Visits (Qty)	
Business Day 2	<i>Within Parameters</i>
Recordings Complete	
Recording Quality	
Packet Loss	
Onsite Visits (Qty)	
Remote Visits (Qty)	
Business Day 3	<i>Within Parameters</i>
Recordings Complete	
Recording Quality	
Packet Loss	
Onsite Visits (Qty)	
Remote Visits (Qty)	
Business Day 4	<i>Within Parameters</i>
Recordings Complete	
Recording Quality	
Packet Loss	
Onsite Visits (Qty)	
Remote Visits (Qty)	
Business Day 5	<i>Within Parameters</i>
Recordings Complete	
Recording Quality	
Packet Loss	
Onsite Visits (Qty)	
Remote Visits (Qty)	
Business Day 6	<i>Within Parameters</i>
Recordings Complete	
Recording Quality	
Packet Loss	
Onsite Visits (Qty)	
Remote Visits (Qty)	
Business Day 7	<i>Within Parameters</i>
Recordings Complete	
Recording Quality	
Packet Loss	
Onsite Visits (Qty)	
Remote Visits (Qty)	
MPLS parameters	less than 5% packet loss
Packet Loss	

Securus Transport 3 Day Validation Plan				
Site Info				
Site ID	Site Name, ST			
Site Name	Tech			
Installer	42481			
Cut Date	Cable			
Circuit Count (version)	1	Version =	Cable	DSL
Adtran Count	1			EoF
Adtran Type	924			MPLS
Phone Count	24	Circuit Speed Up	xxxx	Speed in kbps (from Speed Test if not MPLS)
Firmware Ver.		Circuit Speed Down	xxxx	Note a T1 = 1544 kbps (= 1.544 mbps)
Firmware #1	R11-2-0-E.biz			
Firmware #2				
Firmware #3				
Firmware #4				
Post Install Ticket				
Heat Ticket Number	15433331			
Day 1				
Installer	42481			
Day to be Checked	#VALUE!	Data Source : Orion - interface (ie eth 0/1) Custom Chart - Average Transmit bps		
		: Average Receive bps : Min/Max Transmit bps : Min/Max Receive bps		
Circuit Speed Used in kbps	<i>Transmit</i>	<i>Receive</i>	<i>Transmit Ratio</i>	<i>Receive Ratio</i>
Average kbps Circuit#1	-	-	0	0
Average kbps Circuit#2	-	-	0	0
Average kbps Circuit#3	-	-	0	0
Average kbps Circuit#4	-	-	0	0
Circuit Speed Peak in kbps				
Peak kbps Circuit#1	-	-	0	0
Peak kbps Circuit#2	-	-	0	0
Peak kbps Circuit#3	-	-	0	0
Peak kbps Circuit#4	-	-	0	0
Circuit Bandwidth	<i>Average</i>	<i>Peak</i>		
Circuit#1	0.00%	0.00%		
Circuit#2	0.00%	0.00%		
Circuit#3	0.00%	0.00%		
Circuit#4	0.00%	0.00%		
Circuit Packet Loss (Avg)				
Packet Loss (Avg) Circuit#1				
Packet Loss (Avg) Circuit#2				
Packet Loss (Avg) Circuit#3				
Packet Loss (Avg) Circuit#4				
Circuit Packet Loss (Peak)				
Packet Loss (Peak) Circuit#1				
Packet Loss (Peak) Circuit#2				
Packet Loss (Peak) Circuit#3				
Packet Loss (Peak) Circuit#4				
Day 2				
Installer	4/21/2016			
Day to be Checked	#VALUE!			
Circuit Speed Used in kbps	<i>Transmit</i>	<i>Receive</i>	<i>Transmit Ratio</i>	<i>Receive Ratio</i>
Speed Used Circuit#1	-	-	0	0
Speed Used Circuit#2	-	-	0	0
Speed Used Circuit#3	-	-	0	0
Speed Used Circuit#4	-	-	0	0
Circuit Speed Peak in kbps				

Speed Peak Circuit#1	-	-	0	0
Speed Peak Circuit#2	-	-	0	0
Speed Peak Circuit#3	-	-	0	0
Speed Peak Circuit#4	-	-	0	0
Circuit Avg Bandwidth	<i>Average</i>	<i>Peak</i>		
Bandwidth Avg Circuit#1	0.00%	0.00%		
Bandwidth Avg Circuit#2	0.00%	0.00%		
Bandwidth Avg Circuit#3	0.00%	0.00%		
Bandwidth Avg Circuit#4	0.00%	0.00%		
Circuit Packet Loss (Avg)				
Packet Loss (Avg) Circuit#1				
Packet Loss (Avg) Circuit#2				
Packet Loss (Avg) Circuit#3				
Packet Loss (Avg) Circuit#4				
Circuit Packet Loss (Peak)				
Packet Loss (Peak) Circuit#1				
Packet Loss (Peak) Circuit#2				
Packet Loss (Peak) Circuit#3				
Packet Loss (Peak) Circuit#4				
Day 3				
Installer	4/21/2016			
Day to be Checked	#VALUE!			
Circuit Speed Used in kbps	<i>Transmit</i>	<i>Receive</i>	<i>Transmit Ratio</i>	<i>Receive Ratio</i>
Speed Used Circuit#1	-	-	0	0
Speed Used Circuit#2	-	-	0	0
Speed Used Circuit#3	-	-	0	0
Speed Used Circuit#4	-	-	0	0
Circuit Speed Peak in kbps				
Speed Peak Circuit#1	-	-	0	0
Speed Peak Circuit#2	-	-	0	0
Speed Peak Circuit#3	-	-	0	0
Speed Peak Circuit#4	-	-	0	0
Circuit Avg Bandwidth	<i>Average</i>	<i>Peak</i>		
Bandwidth Avg Circuit#1	0.00%	0.00%		
Bandwidth Avg Circuit#2	0.00%	0.00%		
Bandwidth Avg Circuit#3	0.00%	0.00%		
Bandwidth Avg Circuit#4	0.00%	0.00%		
Circuit Packet Loss (Avg)				
Packet Loss (Avg) Circuit#1				
Packet Loss (Avg) Circuit#2				
Packet Loss (Avg) Circuit#3				
Packet Loss (Avg) Circuit#4				
Circuit Packet Loss (Peak)				
Packet Loss (Peak) Circuit#1				
Packet Loss (Peak) Circuit#2				
Packet Loss (Peak) Circuit#3				
Packet Loss (Peak) Circuit#4				

Securus Call Metric Acceptance						
Site ID	45001					
Site Name	Site Name, ST					
Installer	Tech					
Cut Date	4/21/2016					
Transport Type	Cable					
Week Total	Summary					
Call Volume Total	164,521					
Call Volume Comp	81,585					
Call Volume Incomp	82,936					
Call type	Incomplete Calls	Complete Calls	Total Calls	Threshold	Actual Call Rate	Threshold Met
Advanced Connect	5,740	45,969	51,709	40%	88.90%	Yes
Debit	67,795	26,089	93,884	25%	27.79%	Yes
Direct Bill	560	532	1,092	30%	48.72%	Yes
Free Call	8,638	8,400	17,038	35%	49.30%	Yes
Prepaid Calling Card	203	595	798	60%	74.56%	Yes
Instant Pay	19,691	1,939	21,630	5%	8.96%	Yes
Text2Connect	84	105	189	10%	55.56%	Yes
Pay Now	105	84	189	5%	44.44%	Yes
Account Activator	16,828	1,645	18,473	5%	8.90%	Yes

Securus Product and Feature Acceptance and Fallback Execution			
Product/Feature	Monitoring Definition	Pass/Fail	Fallback Action
Call Recording			
First Calls Free			
Instant Pay - Account Activator			
Instant Pay - Pay Now			
Instant Pay - Text2Connect			
International Calls			
Investigator Pro / CVV			
Investigator Pro Pin Check			
Language Prompts			
Location Based Services (LBS)			
Max Call Duration			
PAN - Automated (Auto PAN)			
Prepaid Calling Cards			
Pre-Recorded Name			
Remote Call Forwarding Detection and Prevention (RCF)			
Securus Voicemail			
System Logging			
TDD/TTY			
THREADS			
Voice Biometrics			
VPM			
3 Way Call Detection			
Allow Calls to Cell Phones			
Alternate Inmate ID, Info & Grouping			
Ask DTN First			
BNA Lookup			
Call Party Block			
Call Tracker			
Caller Name Recording			
Calling Restriction Remaining Announcement			
Calling Restrictions			
Covert Alert			
Crime Tip			
Customer Caller ID			
DTMF Detection			
DTN Limits			
Emergency Calls			
Generate Random PIN			
Global List at Port Group			
ICER			
Informant Line			
Check In SCN UI - Tools / Reports / Officer Check-In			
PAN - Manual			
Passive Acceptance			
Random Announcements			
Random Marketing Announcement			
Recording Indicator			
Recycle PIN			
Scan Patrol Logging			
Site Caller ID			

Virtual Groups			
Wireless Indication			
Secure Instant Mail			
Managed Access (WCS)			
Tablets			
ConnectUs Platform			
ConnectUs - Emergency Call			
ConnectUs - Inmate Handbook			
ConnectUs - Inmate Videos			
ConnectUs - Job Search			
ConnectUs - Module: Commissary Ordering			
ConnectUs - Module: Grievance			
ConnectUs - Module: Law Library			
ConnectUs - Phone Call			
ConnectUs - Website Education			
ConnectUs - Module: Sick Call			
Video Visitation - At Home			
Video Visitation - On Site			
Video Visitation - Storage Retention			

Training Plan

New York State Department of Corrections and Community Supervision
(DOCCS)

January 29, 2016

Purpose

The Purpose of this Training Plan is to analyze and outline training efforts for the *New York State Department of Corrections and Community Supervision (DOCCS)*.

This plan includes a course outline of training topics and exercises and potential training rollout options.

Scope

The scope of this Training Plan is to provide members of the *New York State Department of Corrections and Community Supervision (DOCCS)* on the Securus Call Platform (SCP).

All training courses will include:

- Course Introductions
- Functionality of SCP
- Hands-on exercises
- Certification testing if desired

The course descriptions and allotted times are discussed later in this document.

Stakeholders

Client Project Team:

Name	Role	Phone	Email

Securus Training and Project Team:

Name	Role	Phone	Email

Audience

The identified audience includes:

- Command Staff
- Administrators
- Supervisors (Capt, LT, SGT)
- Investigators
- Correctional Officers
- Inmates

Course Registration

Each student attending must register for training to attend. Each attendee must have an accessible email address in order to register and attend the training and complete a feedback evaluation.

Securus' Training Team will provide a registration link for each training event.

Presenters

The Presenters will be the Securus Customer Training Team.

Training Deck

All training material will be provided to training attendees via Securus University Learning Management System. Each attendee will need to log into Securus University to download.

1. Training PPTX Presentation for each product
2. Job Aids and Reference Material
3. Examination
4. Feedback Evaluation

Needs Analysis

A needs analysis needs to be completed to determine the final scope of the training requirements. This can be accomplished using a MS Excel template and fill-in-the-blank responses to specific questions for each identified role.

This process should take no more than a week, depending on the amount of time to receive the responses for each role.

Methodology

Training

Based on past experiences with technical training classes, if possible, each student should have an available computer to follow along and practice the procedures being trained. Whenever possible, classes should be full to maximize training time, resources, and dollars. However, the training schedule must accommodate the fact that all members of some departments cannot be gone at the same time.

A combination of webinar and onsite training will be implemented.

Webinar

Webinar training is one of the best methods to train large numbers of personnel at multiple locations in the shortest amount of time. Due to potential scheduling conflicts, content, and roles being trained, online webinars can be scheduled for all topics, as needed or in agreement with, the customer.

Customer roles/students such as Read Only, Maintenance, and perhaps some Monitors or Administrators, that may not be actively using the system on a daily basis and who need mainly an overview of feature functionality, can easily learn the content via a webinar.

Student content will be uploaded to the webinar and accessible by each registered student.

Maximum Recommended Students per class: Up to 150/webinar

Onsite

Onsite training provides students with the opportunity to fully interact with the instructor in a classroom setting. In the onsite training, students should each have a functional computer and be able to practice all procedures as they are being taught. Student-Instructor interaction is increased.

Maximum Recommended Students per class: 20

Role-based Training

The training will be Role Based and each role identified by NY DOC could have a separate training schedule. Pending the completion of the Needs Analysis, each role can be assigned to attend specific classes/webinars. The following is a **potential listing** of topics that could be covered based on the roles and customer requirements.

Each role would be trained in all of the primary functions of SCP in order to have a good understanding of SCP's functionality and abilities. Specifics of each training aspect would be dependent on the procedures associated with that role.

Role	Content	Focus	Note
Command Staff	All	<ul style="list-style-type: none">• General overview of SCP and it's functionality• Reports	Command Staff rights and roles are in some areas view and search only depending on client needs and analysis
Administrators	All	<ul style="list-style-type: none">• Reports• Admin Module	Administrators typically focus in the areas of User Management but need a firm understanding of the system and it's capabilities.
Supervisors	All except Admin Module	<ul style="list-style-type: none">• Super-user in areas not relating to User Management• Investigative strategies• Reports	Supervisors are responsible for the daily operations in SCP and in assisting users in performing their tasks. They also, in some cases are responsible for 1:1 support and training.
Investigators	All except Admin Module	<ul style="list-style-type: none">• Investigative and Internal Affairs	Full focus on the investigative functionality and

		techniques and strategies <ul style="list-style-type: none"> • Reports 	aspects of SCP.
Correctional Officers	All except Admin Module	<ul style="list-style-type: none"> • Search Techniques • Monitoring and listening to live and previously recorded calls 	Would not be trained in any aspect of investigative strategies or functionality.

Inmates

- SCP: Dialing instructions can be mounted on each phone, and added to ConnectUs as a document.
- SVV: ConnectUs provides a 2-minute instructional video. Various instructions can be posted as documents on ConnectUs.
- If NY DOC has educational broadcast capability via TVs, we can create a short video to run frequently over internal channels.

Training Schedule

The estimated training times listed below is based on typical times for each topic. Based on the training schedule and roles for each event, some of the times may vary.

Content	Estimated Training Time
Introduction to SCP	40 min
System Module	60 min
Monitor Module	20 min
Tools Module	60 min
Admin Module	60 min
Course Exam and Feedback	30 min

Training Dates and Locations

Training Dates for NY DOC will tentatively begin _____. Training will be scheduled based on requirements TBD from NY DOC Stakeholders.

OPTION 1:

Provide Regional Onsite training for all roles.

OPTION 2:

Provide Regional Onsite training for all roles *except* Correctional Officers who would be trained via webinars.

OPTION 3:

Provide Regional Onsite training for Supervisor and Investigator roles. All other roles would be trained via webinar.

OPTION 4:

Provide Webinar training for all roles.

Objectives

The learning objectives of training are as follows:

Secure Call Platform (SCP)

Upon completion of the training, students will be able to:

- Access and Navigate SCP
- Access and navigate SCP Help
- Demonstrate the Management Level functionality
- Enable/disable phones and control specific calling features
- Create a Call Schedule
- Add a Global List Number
- Add and manage an Inmate Phone Account
- Create Covert Alerts
- Listen to, scan, and forward live calls
- Listen to previously recorded calls
- Burn calls to a CD
- Perform basic and advance searches
- Generate desired reports

- Manage personal passwords

Command Staff and Administrators

- Create a new user
- Explain the creation and modification of a Security Template
- Deactivate/delete a user
- Reset a User Password
- Generate User Management Reports

Course Content

Below is a list of the training courses offered for DOCCS.

Bi-annual Investigative Technology Workshops

Securus recognizes the importance of keeping up with changes in technology. This proposal includes transportation, lodging and food for up to five (5) DOCCS staff to attend bi-annual Investigative Technology Workshops at our state-of-the-art Technology Center, located in Dallas, Texas. These workshops will not only enhance the skills and capabilities of staff; they can function as training and certification opportunities, as well. This is in addition to the on-going training and support provided throughout the contract term

Secure Call Platform (SCP) (Estimated Training Time: 4 hours)

- Course Objective: The course is designed to provide Securus' Associates with an Introduction to Securus Call Platform and provide an understanding of the value and benefits SCP brings to Securus' customers and investigators
- SCP Training Topics - including but not limited to:
 - Introduction to SCP
 - Navigation
 - Management Level
 - Main Menus
 - Help and Technical Support
 - SCP Menus and Functions
 - Systems Menu - including but not limited to:
 - Controlling Phones
 - Global Lists
 - Custody Accounts
 - Investigative Strategies
 - Monitor Menu
 - Listen to live calls

- Scanning Calls
 - Forward Calls
 - Investigative Strategies
- Tools Menu
 - Search for calls
 - Listen to previously recorded calls
 - Basic Search
 - Advanced Search
 - Reports
 - Investigative Strategies
- Admin Menu
 - Password Management
 - User Management
 - Security Templates
 - Job Title Management
- SCP Training Exercises

System Access

Once all attending officers have registered for the training, their names and email addresses will be provided to the Client Manager to ensure that appropriate access is granted. Securus cannot install any application software on non-customer computer systems.

All registered students attending training must have authorized access to the products being presented. It is the responsibility of the *New York State Department of Corrections and Community Supervision (DOCCS)* representative to work with the Securus Client Manager to validate/obtain the required access for each authorized user prior to training.

FACILITIES

Onsite Training Setup

The following includes the *minimum* requirements for each training room:

1. Appropriate desks and chairs for each student
2. If course is not demonstration only, there should be a computer workstation for each student with network connection
3. **ALL computer systems** must be on Windows 10 with the update option for Windows 11 disengaged
4. Securus' applications installed and tested on all computers
5. Overhead Projector and screen connected to Instructor PC

6. Speakers available for instructor PC or already connected to site PC
7. Instructor podium and computer if required
 - a. Instructors will probably bring their own laptop so will need appropriate internet connection and access information
 - b. Instructors will also need access beyond local firewalls if possible
 - c. If instructors will be required to utilize local computer systems, will only need appropriate access and ability to upload content to the PC
8. Whiteboard and markers or flipcharts and markers
9. The instructors will be able to gain access to the training room at least 24 hours in advance to ensure all systems are functional and tested

Information Technology

10. Securus will provide the steps needed to install all of the required software to the Client IT representative. This will include how to test the software for full functionality.
11. Local IT personnel will install and test all Securus' applications on all computers that will be utilized during training including:
 - a. Attending officers' computers
 - b. Training Room Computers
12. Local IT and a Securus Field Service Technician will work together to ensure the software is properly installed and tested on all authorized user's computers.
13. Local IT and a Securus Field Service Technician will work together to ensure the software is properly installed and tested on the Training Room computer.
14. The local IT Department will ensure that there is adequate wireless internet available for all students.
15. Instructors will probably bring their own laptop so will need appropriate internet connection and access information.

SCP Course Modules

Course Module	Objective	Length
Getting Started	<ul style="list-style-type: none"> — What is SCP? — Logging in — Navigating through the features — Managing your password — Contacting Technical Support for service calls 	25
User Administration Activities	<ul style="list-style-type: none"> — Creating and changing user accounts — Defining a user's role and granting access permission — Resetting a user's password — Deactivating and/or deleting users — Running user management reports 	60
Inmate Administration Activities	<ul style="list-style-type: none"> — Adding and changing inmate phone accounts — Deactivating inmate phone accounts — Setting up the phones to meet your requirements — Using administrative reports 	30
Monitoring Activities	<ul style="list-style-type: none"> — Reviewing Call Detail Records (CDRs) — Monitoring live calls — Listening to recorded calls — Using monitoring reports — Saving calls and burning to CD 	60
Investigation Activities	<ul style="list-style-type: none"> — Using CDRs for investigations — Recognizing trends in inmate activity — Using other investigative tools to collect evidence — "Digging" into the details 	40
Super User Activities	<ul style="list-style-type: none"> — Learning time-saving tips and tricks — Discussing actual facility situations and turning evidence into intelligence — Troubleshooting for operational and maintenance staff to minimize unnecessary service calls 	25

SCP Online Help Features

Course Module	Objective	Length
Welcome Page	Provides high-level descriptions for selected features describing their purpose and functions.	15
What is New in SCP	Describes new features in the current release and includes links to receive additional details or task-based instructions.	
Getting Started	Offers task-based procedures to assist officers in efficiently using SCP to get their job done. Each topic includes a link that enables an e-mail to be sent for Technical Support or to Training for online help feedback.	
Related Topics	Links to SCP feature elements such as phones, inmates, investigations, reports, workforce, and administration.	
Pop-up Definitions	Defines glossary terms and word index at the click of a mouse without leaving a topic. This assists the trainee to quickly absorb new concepts and technology.	
Tips and Tricks	Provides shortcuts, helpful hints, and advanced topics for highly-skilled officers looking to improve their performance.	
Frequently Asked Questions (FAQ)	Offers common questions and their answers.	
Troubleshooting	Presents self-help instructions for common functions such as the following:	
Reference	An inmate was released, but I cannot release his PIN.	
Advanced Management Functions	"You must deactivate the Custody Account before you can release the PIN. If you still cannot release the PIN, contact Technical Support."	

SCP Course Training Schedule

Item	Content	Key Points	Time
1	Introduction to SCP	What is SCP? Accessing SCP Basic Navigation Management Level Help and Technical Support	40
2	System Module	Introduction Controlling Phones <ul style="list-style-type: none"> o Disabling Phones o Controlling Specific Phone Features o Call Duration o Call Schedules o Call Restrictions o Investigative Strategies Global Lists - Controlling Phone Numbers <ul style="list-style-type: none"> o Adding a Global List number o Controlling how numbers are handled o Investigative Strategies Custody Accounts <ul style="list-style-type: none"> o Adding Inmate Phone Accounts o Controlling Inmate Phone Accounts o Investigative Strategies 	60
3	Monitor Module	Listening to Live Calls Call Forwarding Scanning Calls Investigative Strategies	20
4	Tools Module	Call Detail Records Listening to Previously Recorded Calls Basic and Advanced Search Call Controls Call Tracker Burning Calls to a CD Investigative Strategies Reports <ul style="list-style-type: none"> o Inmate Reports o Investigative Reports o User Management Reports o Administrative Reports 	60

SCP Course Training Schedule

Item	Content	Key Points	Time
5	Admin Module	Introduction Password Management User Management <ul style="list-style-type: none"> o Search o Creating a New User Account o Changing a User Account o Deactivate/Delete a User o Password Reset Security Templates <ul style="list-style-type: none"> o Create a New Security Template o Modify a Template/User Access User Management Reports Job Title Management <ul style="list-style-type: none"> o Add a Job Title 	60
TOTAL TRAINING TIME			4.00

Communications Plan

Change Management Process

Risk Management and Mitigation Plan

Configuration Management Plan

Provided in this document are the following:

- Method of Communication
- Communications Schedule
- Communication Documents
- Contact Information
- Risk management Process
- Change Management Process

Method of Communication

DOCCS and Securus Technologies will have continuous weekly meetings to review and discuss the progress of the implementation of Inmate Telephone services. The meetings will occasionally have additional associates invited to attend from both companies to discuss current progress and risks associated to the installation.

The discussions will be a collaborative communication using 3 main tools:

- Face to Face meetings to review installation processes onsite at DOCCS
- Conference Calls through the following described bridge numbers
- Email distribution of documentation and updates

Communication Schedule

-  Conduct weekly Tuesday Summary conference call with DOCCS, Project Managers, and other associated parties to review current milestones completions and/or delays and next steps.
 - Dial-in Number: 1-877-710-1114 (subject to change)
 - Access Code: XXXX (subject to change)
 - Date: Each Tuesday
 - Time: 10:30 am CST

Communications Plan Revisions

Revision Date	Initiator	Description of Revision	Approved By	Revision Approval Date

--	--	--	--	--

Communication Documents

Document	Recipients	Purpose	Update Frequency
Project Charter	Project Management Team	Define scope, risk, constraints	As required
Risk Management Document	Project Management Team	Capture risks and process outline for managing issues	As required
Contractual Requirements Tracker	Project Management Team	Capture Contract requirements	As required
Change Control Document	Change Control Board (See below)	Manage Changes	Weekly or as required
Project Plan	Project Management Team	Track progress of project tasks	As required
Status Report	Project Stakeholders, Project Management Team	Provide status and updates	Weekly

TEAM GOALS

- Coordinate all of the appropriate vendors and resources
- Understand the risks and issues which can arise during install
- Document efficiently to monitor progress to completion
- Improve communication with all parties throughout the implementation process

Contact Information

DOCCS and Securus Technologies Project Team				
Communications Roster				
Name/Title/Role	Email/Phone	Method by Priority		
		High	Med	Low
- Executive Sponsor DOCCS – (Title)	Email and Phone number			
NAME – Project Stakeholder DOCCS – (Title)				
NAME – Project Stakeholder DOCCS – (Title)				
NAME – Project Stakeholder DOCCS – (Title)				
NAME – Project Stakeholder DOCCS – (Title)				
NAME – Project Stakeholder DOCCS – (Title)				
NAME – Project Stakeholder DOCCS – (Title)				
NAME – Project Stakeholder DOCCS – (Title)				
Mr. Russell Roberts – Executive Sponsor Securus Technologies – Vice President				
NAME – Project Stakeholder Securus Technologies - Sales Vice President				
NAME – Project Stakeholder Securus Technologies – National Sales				

Name/Title/Role	Email/Phone	Method by Priority		
		High	Med	Low
Manager				
NAME - Project Stakeholder Securus Technologies - Senior Territory Manager				
Debbie Cates - Project Stakeholder Securus Technologies - Director, Technical Support				
John Mannewitz - Project Stakeholder Securus Technologies - Manager, Service Operations Support				
Monica Garcia - Project Stakeholder Securus Technologies - Supervisor, Implementation - Project Management				
NAME - Project Stakeholder Securus Technologies - Implementation, Project Manager				
Terry Bessent - Project Stakeholder Implementation Consultant				
NAME - Project Stakeholder Securus Technologies - Senior Regional Manager, Field Service				
NAME - Project Stakeholder Securus Technologies - Regional Manager, Field Service				
NAME - Project Stakeholder Securus Technologies - Manager, Field Services				

Name/Title/Role	Email/Phone	Method by Priority		
		High	Med	Low

Risks Management Process

APPROPRIATE CORRECTIVE MEASURES

- Identify issue or risk and perform probability assessment
- Notify Project Manager
- Project Manager will document, resolve and close
- Project Manager will escalate and notify Project Sponsor(s) of risks that cannot be resolved

TRACKING RISKS AND ISSUES

Tracking and monitoring of risks and issues will be documented on the Risk Management Document and the Issues Management Document. Keeping track of these items will assist in driving directives to complete or submit for a change control of the scheduled operations.

Change Management Process

CHANGE MANAGEMENT PROCESS STEPS

Any and all project changes will be discussed with and approved by (list all those who are the key stakeholders of making a process change)

CHANGE MANAGEMENT PROCESS FLOW

Changes that are out of scope (not defined in the original Project Charter or RFP Response) will be presented to the CCB for approval before consideration for implementation.

CHANGE CONTROL BOARD (CCB) MEMBERS

NAME – DOCCS

NAME – DOCCS

NAME – DOCCS

NAME – DOCCS

AM – Securus

SVP – Securus

PM – Securus

PM Supervisor – Securus

Performance and Service Level Plan

Securus and NY DOC - Performance and Testing action register									
Test	Test Name	Securus Procedure to validate	NY Procedure to validate	Securus Test Results	NY Test Results	Date	Hours	COMPLETE	
1									
2									
3									
4									
5									
6									
7									
8									
9									

Securus and NY - Data Integration Performance

S.No	Data Name	File name	Transmission method	Transmission Schedule	Data Elements	Process Output	Expected Output	Verification Information	Passed/Failed Test Results
1									
2									
3									
4									
5									
6									
7									
8									
9									
10									

Securus and NY DOC - Reporting and call processing Mechanism results						
Test Sequence	Test Name	Required Setup	Test Script	Confirmation Script	Expected Results	PASS/FAILED
						Test Results Tracking
1						
2						
3						
4						
5						
6						
7						
8						
9						
10						
11						
12						



Securus Inmate Telephone Service and Tablet Solution

PROJECT CHARTER

For

***New York State Department of Corrections and
Community Supervision (DOCCS)***

***Department: Inmate Services-
Implementation***

***Project: Inmate Telephone Service
and Tablet Solution***

***Sponsor: (Site/State Main Decision
Maker)***

Project Manager: (Securus Project Manager)

Date: July 5th , 2017

CHARTER REVISIONS

Revision Date	Initiator	Description of Revision	Approved By	Revision Approval Date

Document Information

This document represents the Project Charter, an official document that authorizes the Project Manager to commit resources to work on the project. The Project Charter is completed during the *Initiation Phase* of the *LEAN* Project Management Methodology.

Project Charter Approvers (Key Stakeholders):

Project Sponsor: The person, who champions, secures financial resources and provides strategic direction for the project. There could be more than one project sponsor.

Business Owner: The individual responsible for the final project product or desired outcome. (Note: The project sponsor and the business owner may be the same person for the project.)

Project Manager: The person assigned to the project to achieve project objectives and to manage day-to-day activities including the development of the project plan, conducting project reviews and disposing of issues and change requests.

Other Key Executive Stakeholders: A Senior Cabinet member (or designated representative) of any other department (e.g., Finance, Facilities, or Legal) who commits to provide resources to assist with the project. There could be more than one additional departmental representative. If applicable, list separately a representative for each Department involved in the project.

Project Stakeholders and Participants

The project team will consist of members from DOCCS and Securus Technologies. The following table identifies the project participant's title and contact information:

Name/Title/Role	Email/Phone
NAME - Executive Sponsor DOCCS - Title	Phone Number Email Address
Mr. Robert Pickens – Executive Sponsor Securus Technologies - Chief Operating Officer	972-277-0300 bpickens@securustech.net
NAME - Project Stakeholder DOCCS - Commander; Custody Command	Phone Number Email Address
NAME - Project Stakeholder DOCCS - Director Commander; Intelligence Division	Phone Number Email Address
NAME - Project Stakeholder DOCCS - Telecommunications Commander	Phone Number Email Address
NAME - Project Stakeholder DOCCS - Deputy Chief, Technology Management Bureau	Phone Number Email Address
NAME - Project Stakeholder DOCCS - Chief of Administration	Phone Number Email Address
NAME - Project Stakeholder DOCCS - Chief of Detention	Phone Number Email Address
NAME - Project Stakeholder DOCCS - Lieutenant; Custody Business Ops/Special Projects	Phone Number Email Address

Name/Title/Role	Email/Phone
NAME - Project Stakeholder DOCCS - Procurement Officer	Phone Number Email Address
Debbie Cates - Project Stakeholder Securus Technologies - Director, Technical Support	972-277-0314 dcates@securustech.net
John Mannewitz - Project Stakeholder Securus Technologies - Manager, Service Operations Support	972-277-0577 jmannewitz@securustech.net
NAME - Project Stakeholder Securus Technologies - Sales Vice President	Phone Number Email Address
NAME - Project Stakeholder Securus Technologies - Major Account Manager	Phone Number Email Address

Project Stakeholders and Participants – continued:

The project team will consist of members from DOCCS and Securus Technologies. The following table identifies the project participant’s title and contact information:

Name/Title/Role	Email/Phone
NAME - Project Manager DOCCS - Senior Capital Project Manager	Phone Number Email Address
NAME - Project Manager DOCCS- Officer; Custody Business Ops/Special Projects	Phone Number Email Address
NAME - Project Manager DOCCS - Telecommunications Analyst	Phone Number Email Address

Name/Title/Role	Email/Phone
NAME - Project Manager Securus Technologies - Implementation Project Manager	Phone Number Email Address
NAME - Project Team DOCCS - Office of Enterprise Technology; Senior Project Manager	Phone Number Email Address
NAME - Project Team DOCCS - Network Administrator	Phone Number Email Address
NAME - Project Team DOCCS - Commander of Mainframe Operations & Tech. Support	Phone Number Email Address
NAME - Project Team Securus Technologies - Client Manager	Phone Number Email Address
NAME - Project Team Securus Technologies - Field Marketing Analyst	Phone Number Email Address

Project Stakeholders and Participants Responsibilities

The project team will consist of members from DOCCS and Securus Technologies. The following identifies the project participant's role and associated responsibilities:

DOCCS Executive Project Sponsor – (Main Site/State Contact)

- Provides executive direction to the project team
- Provides funding and financial approval for the project
- Participates in formal project status review process
- Reviews and approves date changes to project's master schedule
- Makes all final critical decisions when necessary

DOCCS Project Owner – (Site/State Contact)

- Participates in formal project status review process
- Reviews all project deliverables
- Provides interface and communications into other areas of DOCCS organization as needed
- Coordinates access to and scheduling for DOCCS Facilities staff
- Sign-off and acceptance of deliverables
- Reviews and approves date changes to project's master schedule
- Reviews and approves project change requests
- Makes all final critical decisions when necessary

DOCCS IT – (Site/State Contact)

- Provides interface and communications into other DOCCS IT organization
- Coordinates access to DOCCS and systems as needed at the main office and remote locations, if necessary
- Participates in design review and approval
- Facilitates design review and approval by DOCCS

Securus Executive Project Sponsor – Mr. Robert Pickens

- Provides executive direction to the Securus project team
- Provides guidance to the project team's leadership regarding project activities, scheduling, resource allocation, etc.
- Provides guidance to the project team with regard to project scope, tools, and processes
- Reviews all project deliverables (documents)

- Responsible for all deliverables

Securus Project Owner – (Securus SVP, Account Manager)

- Responsible for successful completion of the project
- Support Project Manager and directs Securus project team
- Participates in formal project status review process
- Reviews all project deliverables
- Sign-off and acceptance of deliverables
- Reviews and approves date changes to project's master schedule
- Reviews and approves project change requests
- Makes all final critical decisions when necessary

Project Managers – (Securus PM/management, DOCCS PM and staff)

- Serves as the central point of communication between DOCCS and Securus
- Facilitates all formal project communications
- Develops and maintains a detailed project plan and schedule
- Manages project logistics for scheduling project activities and resources
- Owns all project documentation including contracts, project change requests, official meeting minutes, and customer signoffs
- Handles miscellaneous information requests from project team members
- Provides both hard copy and electronic documentation
- Supports all phases of the project

1. Project Mission

1.1. *Mission Statement*

Provide an innovative hosted solution for inmate telephone services and tablets across DOCCS facilities on time and within budget.

1.2. *Business Need*

DOCCS desires a highly reliable and affordable service solution that will give DOCCS the support and capabilities to perform oversight and monitoring of inmate telephone calls and tablet utilization while maximizing contributions to the inmate general welfare fund.

1.3. *Project Product*

A complete and secure turn-key integrated inmate communications system with the benefit of value added features as future opportunities.

2. Project Duration (Approximate)

July 5, 2017 - October 2, 2017

3. In Scope and Responsible Parties

(Sample of installation Scope of work details. Need to replace all information for what is in the RFP and/or Contract)

Item	Responsible
1. Inmate Telephone System/ Tablets <ul style="list-style-type: none"> a. Installation HW/SW b. Transport Installation c. Integration with JMS d. Acceptance Testing Plan e. Reference Materials f. Training Plan g. Marketing and Media Relations Assistance h. Software Updates (as they become available) 	Securus *** (Item: 1d) - Shared responsibility with DOCCS (Item: 2)
2. Interfaces –2 Complete Integrations Total <ul style="list-style-type: none"> a. From: DOCCS JMS to Securus for inmate information (Tablets) b. From: DOCCS IFCS to Securus for commissary information as applicable (Tablets) 	DOCCS (JMS/IFCS), Securus *** DOCCS will review and approve data provided to vendors from their JMS system, to ensure authenticity. DOCCS will ensure compliance with CJIS dissemination policies. DOCCS will assist in resolving any roadblocks related to their JMS during all integration phases, as needed.

4. Out of Scope Items

Securus Technologies:

Lists all items which are identified during planning meetings which are discussed which have not been approved for the current installation.

2.

DOCCS:

Business rules - which have not been identified in the RFP and translated to the contract as items which are required for installation.

5. Constraints

Constraints are those "restrictions" that affect when an activity can be scheduled. Those "restrictions" are SCOPE, TIME, & COST.

1. Integration testing matrix and validation points
2. Additional development items which are outside the Securus products and features
3. Transport configurations

4. Transport installation timelines
5. Contractor requirements
6. Contractor costs associated to hardware deployment
7. Facility related duties outside of Securus control and SLA
8. Facility Escort availability during circuit and hardware installations
9. Hardware delivery timelines based on project volume

6. Risks

A risk is something that may happen and if it does, will have an adverse impact on the project.

1. Integration Development items – Non Securus standard data transfer rules
2. Telecom delivery time lines
3. Transport delivery within SLA
4. Scope changes outside of contract
5. Change in Scope of work of hardware requirements
6. Security Templates identified

Site/State Stakeholder Name	Signature	Date
------------------------------------	------------------	-------------

Site/State Stakeholder Name	Signature	Date
------------------------------------	------------------	-------------

Site/State Stakeholder Name	Signature	Date
------------------------------------	------------------	-------------

Securus Stakeholder Name	Signature	Date
---------------------------------	------------------	-------------

Securus Stakeholder Name	Signature	Date
---------------------------------	------------------	-------------

Securus Stakeholder Name	Signature	Date
---------------------------------	------------------	-------------

2. Project Lessons-Learned Document / Signatures

Project Manager(s): Name – Location, Title
 Name – Securus Technologies, Implementation Project Manager

I have reviewed the information contained in this Project Lessons-Learned Document and agree:

Name	Title	Signature	Date (MM/DD/YYYY)
NAME	Stakeholder for Site/State	✕ _____	
NAME	Stakeholder for Site/State	✕ _____	
NAME	Implementation Project Manager – Securus Technologies	✕ _____	
NAME	Supervisor, Project Management – Securus Technologies	✕ _____	
NAME	Major Account Manager – Securus Technologies	✕ _____	
NAME	Field Service Manager – Securus Technologies	✕ _____	

The signatures above indicate an understanding of the purpose and content of this document by those signing it. By signing this document, they agree to this as the formal Project Lessons-Learned Document.

3.8.1.1 Project Manager

The vendor shall provide a fulltime project manager for the duration of the implementation until DOCCS has accepted all system components and services. The project manager shall be responsible for the development and implementation of the project plan, all transition and migration requirements and acceptance testing. Within 14 days of the notification of tentative contract award, the selected bidder must provide a résumé for its proposed Project Manager for DOCCS' approval. The State reserves the right to require additional information, including the use of direct interviews and demonstrations, to make a determination of the proposed Project Manager's qualifications. DOCCS reserves the right to accept or reject any proposed candidates for this position.

SECURUS HAS READ, AGREES AND WILL COMPLY WITH THIS REQUIREMENT.

3.8.1.2 DOCCS' Resources

In the Proposal, provide a breakdown of DOCCS' staff resources required for implementation, migration, and operation of their proposed solution.

SECURUS HAS READ, AGREES AND WILL COMPLY WITH THIS REQUIREMENT.

See 3.8.1 – Project Plan (page 226)

3.8.1.3 Site Survey

After notice of tentative away, the selected vendor shall be responsible for performing a site survey at all of DOCCS' facilities and identifying all installation and facility issues that could impact implementation.

SECURUS HAS READ, AGREES AND WILL COMPLY WITH THIS REQUIREMENT.

3.8.2 Call Recording Migration

DOCCS currently stores one year of recordings within the existing ITS platform. The vendor must transfer existing recordings from the current vendor system to the proposed system without loss of information, chain of custody and playback ability.

Describe the plan for this migration.

SECURUS HAS READ, AGREES AND WILL COMPLY WITH THIS REQUIREMENT.

Per the Official Responses to Questions, Answer to Question 31, DOCCS agrees to amend 3.12 of the RFP to include the ability for a phase-out plan to allow the option of a "leave behind" system to maintain access to existing recordings upon expiration of the contract resulting from the RFP at the sole discretion of DOCCS.

Securus has significant experience transitioning to SCP from your current platform. We will work with the existing vendor to provide leave-behind access to the existing recordings and call detail records.

The plan for doing so will have to be worked out between Securus and the current vendor after contract award. The details and timing of the plan will be dependent on the cooperation of the current vendor and the technical characteristics of its data storage system. Securus will keep DOCCS apprised of the status of the plan and its progress as it is implemented.

3.8.3 Fallback Plan

As part of the proposal, **provide details and procedures for the fallback plan to restore all services to the prior system in the event of failure upon cutover.**

SECURUS HAS READ, AGREES AND WILL COMPLY WITH THIS REQUIREMENT.

See 3.8.1 – Fallback Plan (page 226)

3.8.4 Acceptance Testing

The project plan must include a draft Acceptance Test developed by the vendor. DOCCS will evaluate this plan for comprehensiveness **and reserves the right to make modifications to the plan to meet DOCCS' needs.** Failure to successfully complete the Acceptance Test may result in termination of vendor services and cancellation of the contract. DOCCS shall be the sole determinant of the success of the Acceptance Test. Billing for services under the contract will be contingent on the satisfactory completion of the Acceptance Test. If the initial acceptance test is not successfully accomplished, DOCCS, at its sole discretion, may require a retest of one or more of the acceptance test criterion.

SECURUS HAS READ, AGREES AND WILL COMPLY WITH THIS REQUIREMENT.

Acceptance Test Plan

PROJECT ACCEPTANCE

INMATE TELEPHONE AND TABLET IMPLEMENTATION

NEW YORK STATE DEPARTMENT OF CORRECTIONS AND COMMUNITY SUPERVISION

1220 WASHINGTON AVE BLDG 2

ALBANY, NY 12226

PROJECT ACCEPTANCE OF THE INMATE TELEPHONE SYSTEM

This document establishes formal acceptance of all the deliverables for Inmate Telephone System Project. The Inmate Telephone System Project has met all the acceptance criteria as defined in the requirements document and project scope statement. A project audit has been performed to verify that all deliverables meet performance and product requirements. Additionally a product evaluation has been performed and determined that all products meet the quality and functional requirements defined within this project.

Transition to Operations has been completed. The live system has been handed over to Operations and the transfer of knowledge from the Project Team to Operations has also been completed. All training has concluded and the System Operations Guide has been handed over to Operations.

The Project Manager is authorized to continue with the formal close out of this project phase. The closeout process will include a post-project review, documentation of lessons learned, and release of the Project Team, close out all procurements and archive all relevant project documents. Once the closing process is completed the Project Sponsor will be notified and the Project Manager will then be released from this project phase.

SPONSOR ACCEPTANCE

Approved by the Project Sponsor:

Date: _____

Project Sponsor Name

Project Sponsor Title

Acceptance Test of Integration

W e b S e r v i c e s	"Create Account" on SCN/or "NewAcct Trans" on Unisys
	"Apply Payment" SCN/DLT /or "Prepaid Funding Trans" on Unisys /or "Credit"
	If "Automated Check" - Release Account on SCN/DLT / or "Credit On Release on Unisys" transactions processing, ALL: confirm at least one has a balance over 0.00
	Acct Auth, Order item, Apply Payment (DLT)
	NO Backouts on Trust / if found, validate reason w/ Vendor
	Location Update (SCN/ Unisys) - continued updated after go-live pin updates successful
S C P U I	# of Active Custody Accounts in SCP is equal to vendor count or complete file - validate SCP is not growing at go-live and at 7 days
	Check Custody Account Change logs - confirm no manual pin changes being entered unless retain pin enabled, if found, notify PM
	If retain SCP pin was requested, confirm pins don't change in SCP UI when FTP files are processed
	Recycle Pin (recommend w/debit) confirm "no pin" on inactive accounts
	1st Call Free (FCF) calls processing (for new and rebooked inmates)
	COBP - inmate calls are successful (not just completed)
	Debit Call Type 2 - successful
	If using Trust, Call Type 3 is successful
F T P	Eimports/ PETL - confirm complete file is 10% larger than min. set (or set a min record count if needed)
	If Instant Refunds - confirm we are not processing complete or release files
S V V	SVV - confirm complete file is 10% larger than min. set
	Movements are successful
V G	No errors, groups are being populated
P r o v i s i o n i n g	For Automated Check refunds - confirm E-imports Debit Refund box is unchecked - ALSO CONFIRM THAT REFUNDS ARE PROCESSING IN WEBSERVICE**
	Confirm Western Union prompts do NOT play if the sites does not use Western Union

SW 7 Day Install Monitoring	
Site Info	
Site ID	
Site Name	
Installer	
Cut Date	
Cable	
Bonded	
Adtran Count	
Adtran Type	
Station Count	
Business Day 1	<i>Within Parameters</i>
1st 24hr Recordings	
Packet Loss	
Onsite Visits (Qty)	
Remote Visits (Qty)	
Business Day 2	<i>Within Parameters</i>
Recordings Complete	
Recording Quality	
Packet Loss	
Onsite Visits (Qty)	
Remote Visits (Qty)	
Business Day 3	<i>Within Parameters</i>
Recordings Complete	
Recording Quality	
Packet Loss	
Onsite Visits (Qty)	
Remote Visits (Qty)	
Business Day 4	<i>Within Parameters</i>
Recordings Complete	
Recording Quality	
Packet Loss	
Onsite Visits (Qty)	
Remote Visits (Qty)	
Business Day 5	<i>Within Parameters</i>
Recordings Complete	
Recording Quality	
Packet Loss	
Onsite Visits (Qty)	
Remote Visits (Qty)	
Business Day 6	<i>Within Parameters</i>
Recordings Complete	
Recording Quality	
Packet Loss	
Onsite Visits (Qty)	
Remote Visits (Qty)	
Business Day 7	<i>Within Parameters</i>
Recordings Complete	
Recording Quality	
Packet Loss	
Onsite Visits (Qty)	
Remote Visits (Qty)	
MPLS parameters	less than 5% packet loss
Packet Loss	

Securus Transport 3 Day Validation Plan				
Site Info				
Site ID	Site Name, ST			
Site Name	Tech			
Installer	42481			
Cut Date	Cable			
Circuit Count (version)	1	Version =	Cable	DSL
Adtran Count	1			EoF
Adtran Type	924			MPLS
Phone Count	24	Circuit Speed Up	xxxx	Speed in kbps (from Speed Test if not MPLS)
Firmware Ver.		Circuit Speed Down	xxxx	Note a T1 = 1544 kbps (= 1.544 mbps)
Firmware #1	R11-2-0-E.biz			
Firmware #2				
Firmware #3				
Firmware #4				
Post Install Ticket				
Heat Ticket Number	15433331			
Day 1				
Installer	42481			
Day to be Checked	#VALUE!	Data Source : Orion - interface (ie eth 0/1) Custom Chart - Average Transmit bps		
		: Average Receive bps : Min/Max Transmit bps : Min/Max Receive bps		
Circuit Speed Used in kbps	<i>Transmit</i>	<i>Receive</i>	<i>Transmit Ratio</i>	<i>Receive Ratio</i>
Average kbps Circuit#1	-	-	0	0
Average kbps Circuit#2	-	-	0	0
Average kbps Circuit#3	-	-	0	0
Average kbps Circuit#4	-	-	0	0
Circuit Speed Peak in kbps				
Peak kbps Circuit#1	-	-	0	0
Peak kbps Circuit#2	-	-	0	0
Peak kbps Circuit#3	-	-	0	0
Peak kbps Circuit#4	-	-	0	0
Circuit Bandwidth	<i>Average</i>	<i>Peak</i>		
Circuit#1	0.00%	0.00%		
Circuit#2	0.00%	0.00%		
Circuit#3	0.00%	0.00%		
Circuit#4	0.00%	0.00%		
Circuit Packet Loss (Avg)				
Packet Loss (Avg) Circuit#1				
Packet Loss (Avg) Circuit#2				
Packet Loss (Avg) Circuit#3				
Packet Loss (Avg) Circuit#4				
Circuit Packet Loss (Peak)				
Packet Loss (Peak) Circuit#1				
Packet Loss (Peak) Circuit#2				
Packet Loss (Peak) Circuit#3				
Packet Loss (Peak) Circuit#4				
Day 2				
Installer	4/21/2016			
Day to be Checked	#VALUE!			
Circuit Speed Used in kbps	<i>Transmit</i>	<i>Receive</i>	<i>Transmit Ratio</i>	<i>Receive Ratio</i>
Speed Used Circuit#1	-	-	0	0
Speed Used Circuit#2	-	-	0	0
Speed Used Circuit#3	-	-	0	0
Speed Used Circuit#4	-	-	0	0
Circuit Speed Peak in kbps				

Speed Peak Circuit#1	-	-	0	0
Speed Peak Circuit#2	-	-	0	0
Speed Peak Circuit#3	-	-	0	0
Speed Peak Circuit#4	-	-	0	0
Circuit Avg Bandwidth	<i>Average</i>	<i>Peak</i>		
Bandwidth Avg Circuit#1	0.00%	0.00%		
Bandwidth Avg Circuit#2	0.00%	0.00%		
Bandwidth Avg Circuit#3	0.00%	0.00%		
Bandwidth Avg Circuit#4	0.00%	0.00%		
Circuit Packet Loss (Avg)				
Packet Loss (Avg) Circuit#1				
Packet Loss (Avg) Circuit#2				
Packet Loss (Avg) Circuit#3				
Packet Loss (Avg) Circuit#4				
Circuit Packet Loss (Peak)				
Packet Loss (Peak) Circuit#1				
Packet Loss (Peak) Circuit#2				
Packet Loss (Peak) Circuit#3				
Packet Loss (Peak) Circuit#4				
Day 3				
Installer	4/21/2016			
Day to be Checked	#VALUE!			
Circuit Speed Used in kbps	<i>Transmit</i>	<i>Receive</i>	<i>Transmit Ratio</i>	<i>Receive Ratio</i>
Speed Used Circuit#1	-	-	0	0
Speed Used Circuit#2	-	-	0	0
Speed Used Circuit#3	-	-	0	0
Speed Used Circuit#4	-	-	0	0
Circuit Speed Peak in kbps				
Speed Peak Circuit#1	-	-	0	0
Speed Peak Circuit#2	-	-	0	0
Speed Peak Circuit#3	-	-	0	0
Speed Peak Circuit#4	-	-	0	0
Circuit Avg Bandwidth	<i>Average</i>	<i>Peak</i>		
Bandwidth Avg Circuit#1	0.00%	0.00%		
Bandwidth Avg Circuit#2	0.00%	0.00%		
Bandwidth Avg Circuit#3	0.00%	0.00%		
Bandwidth Avg Circuit#4	0.00%	0.00%		
Circuit Packet Loss (Avg)				
Packet Loss (Avg) Circuit#1				
Packet Loss (Avg) Circuit#2				
Packet Loss (Avg) Circuit#3				
Packet Loss (Avg) Circuit#4				
Circuit Packet Loss (Peak)				
Packet Loss (Peak) Circuit#1				
Packet Loss (Peak) Circuit#2				
Packet Loss (Peak) Circuit#3				
Packet Loss (Peak) Circuit#4				

Securus Call Metric Acceptance						
Site ID	45001					
Site Name	Site Name, ST					
Installer	Tech					
Cut Date	4/21/2016					
Transport Type	Cable					
Week Total	Summary					
Call Volume Total	164,521					
Call Volume Comp	81,585					
Call Volume Incomp	82,936					
Call type	Incomplete Calls	Complete Calls	Total Calls	Threshold	Actual Call Rate	Threshold Met
Advanced Connect	5,740	45,969	51,709	40%	88.90%	Yes
Debit	67,795	26,089	93,884	25%	27.79%	Yes
Direct Bill	560	532	1,092	30%	48.72%	Yes
Free Call	8,638	8,400	17,038	35%	49.30%	Yes
Prepaid Calling Card	203	595	798	60%	74.56%	Yes
Instant Pay	19,691	1,939	21,630	5%	8.96%	Yes
Text2Connect	84	105	189	10%	55.56%	Yes
Pay Now	105	84	189	5%	44.44%	Yes
Account Activator	16,828	1,645	18,473	5%	8.90%	Yes

Securus Product and Feature Acceptance and Fallback Execution			
Product/Feature	Monitoring Definition	Pass/Fail	Fallback Action
Call Recording			
First Calls Free			
Instant Pay - Account Activator			
Instant Pay - Pay Now			
Instant Pay - Text2Connect			
International Calls			
Investigator Pro / CVV			
Investigator Pro Pin Check			
Language Prompts			
Location Based Services (LBS)			
Max Call Duration			
PAN - Automated (Auto PAN)			
Prepaid Calling Cards			
Pre-Recorded Name			
Remote Call Forwarding Detection and Prevention (RCF)			
Securus Voicemail			
System Logging			
TDD/TTY			
THREADS			
Voice Biometrics			
VPM			
3 Way Call Detection			
Allow Calls to Cell Phones			
Alternate Inmate ID, Info & Grouping			
Ask DTN First			
BNA Lookup			
Call Party Block			
Call Tracker			
Caller Name Recording			
Calling Restriction Remaining Announcement			
Calling Restrictions			
Covert Alert			
Crime Tip			
Customer Caller ID			
DTMF Detection			
DTN Limits			
Emergency Calls			
Generate Random PIN			
Global List at Port Group			
ICER			
Informant Line			
Check In SCN UI - Tools / Reports / Officer Check-In			
PAN - Manual			
Passive Acceptance			
Random Announcements			
Random Marketing Announcement			
Recording Indicator			
Recycle PIN			
Scan Patrol Logging			
Site Caller ID			

Virtual Groups			
Wireless Indication			
Secure Instant Mail			
Managed Access (WCS)			
Tablets			
ConnectUs Platform			
ConnectUs - Emergency Call			
ConnectUs - Inmate Handbook			
ConnectUs - Inmate Videos			
ConnectUs - Job Search			
ConnectUs - Module: Commissary Ordering			
ConnectUs - Module: Grievance			
ConnectUs - Module: Law Library			
ConnectUs - Phone Call			
ConnectUs - Website Education			
ConnectUs - Module: Sick Call			
Video Visitation - At Home			
Video Visitation - On Site			
Video Visitation - Storage Retention			

3.8.5 Equipment Disposal

The contractor shall be responsible for the removal and environmentally certified disposal of all existing unused ITS equipment no later than 120 days after the successful completion of the acceptance test.

The contractor will be responsible for removal of all equipment replaced during the term of the contract at no cost to DOCCS. All data and software must be completely removed and destroyed in compliance with DOCCS security policies and procedures and certification of the completed decimation process provided.

SECURUS HAS READ, AGREES AND WILL COMPLY WITH THIS REQUIREMENT.

3.9 Data Exchange

The ITS contractor and DOCCS' computing systems routinely exchange data to provide timely updates to the ITS that allow proper validation of an attempted call prior to processing. The contractor must comply with the frequency and data exchange format as specified in Attachment D, *Data Exchange Elements*, and provide communication access for the data exchange 24 hours per day. Where appropriate, DOCCS will make a reasonable attempt to add or modify formats or schemas to accommodate the vendor for new services implemented resulting from a contract award. Data Exchange Specifications are subject to change during the resulting contract term.

SECURUS HAS READ, AGREES AND WILL COMPLY WITH THIS REQUIREMENT.

3.9.1 National Information Exchange Model (NIEM) Standards

The contractor agrees to migrate the existing data exchange requirements to data standards consistent with the NIEM as they become operational for ITS data elements at no cost to DOCCS. The bidder may find additional information regarding NIEM standards at <http://www.niem.gov>.

SECURUS HAS READ, AGREES AND WILL COMPLY WITH THIS REQUIREMENT.

3.9.2 Data Reconciliation

The vendor shall provide on a weekly basis all data to DOCCS in a format specified by DOCCS in Attachment D for the purposes of data reconciliation. DOCCS will reconcile the vendor's data and transmit exceptions in the same format as the daily modifications as specified in Attachment D. The vendor shall accept the modifications as the master record.

SECURUS HAS READ, AGREES AND WILL COMPLY WITH THIS REQUIREMENT.

3.10 Information Ownership

~~DOCCS shall own all inmate data, call recordings, and customer account records (collect call, pre paid, and credit), and DOCCS' information developed, stored or used in the ITS. The vendor shall act as custodian of that information in accordance with applicable statutes,~~

~~policies, regulations and procedures and shall provide the information to DOCCS upon request in a form and manner specified by DOCCS. The vendor agrees not to sell, use, share or display any data or to use data for any other purpose unless agreed upon, in writing, by DOCCS.~~

DOCCS shall own all inmate data and call recordings and DOCCS' information developed, stored or used in the ITS. Vendor shall provide DOCCS access to customer account records excluding private financial data. (replaced by Addendum II)

SECURUS HAS READ, AGREES AND WILL COMPLY WITH THIS REQUIREMENT.

3.11 Security

Due to the sensitive, public safety nature of the services under the resulting contract, the vendor must describe, in detail, the security measures that will be taken for personnel, data, communications, systems and facilities in a Security Plan.

The security plan must address the steps the vendor will take with regard to protecting all information and services that result from this RFP.

Describe the security plan, including specific processes and procedures that your company will take to ensure the confidentiality of all information and data.

SECURUS HAS READ, AGREES AND WILL COMPLY WITH THIS REQUIREMENT.

Securus Technologies has a dedicated staff of IT Security Professionals with multiple security certifications such as CISSP, CISA and Infosec Evaluation Methodology from the National Security Agency. The Information Security Framework used at Securus is based on the NIST 800 series of standards which provides a solid basis for assuring the confidentiality, integrity and availability of information is adequately secured based on risk and value.

Securus Technologies is compliant with multiple regulations and standards such as CPNI, and state PII notification laws. These controls have been confirmed through external SAS-70 and SOX audits. As stated earlier in this response, Securus is the only inmate telephone manufacturer and service provider to be certified as compliant within the Sarbanes-Oxley Act and also is the only provider to be able to obtain a SAS-70, Type II audit certification.

Information Security

December 2016

Table of Contents

Securus Technologies - Confidential Page

Securus Technologies - Confidential Page

3.11.1 ITS System Security

The vendor shall describe the ITS system security for all data stored locally or in a central database.

Describe the proposed security system. All information must be encrypted.

SECURUS HAS READ, AGREES AND WILL COMPLY WITH THIS REQUIREMENT.

Securus Technologies utilizes a “least access privilege” methodology in which information is restricted to a “need to know” basis. Confidential information is encrypted during transmission based on data risk assessments. Access to systems is restricted using unique login credentials to assure non-repudiation which is tied to password policy controls that include length, complexity and expiration requirements. A formal change control process is utilized for access to the production systems that incorporate a privileged account checkout process to assure that access is granted to only the systems being affected and only for the duration of the authorized change control.

The Securus Secure Call Platform (SCP) provides an advanced, multi-level password scheme specifically designed to provide facility administrators the ability to assign unique levels of access to anyone using the different features of the SCP. There are view and change options for each module depending on the need of the user.

Manage, Create, Edit, Predefine User Levels in SCP

Administrators can manage, review, edit, and delete all security "templates", predefine templates, and add new templates as required - all from one location in SCP.

NAME	DESCRIPTION	PREDEFINED
3rd Shift - blocking only	Night jailers can block number but no changes otherwise	
5.0 Huong test	Huong test	
5.0.1 Add Template	Huong Test	
5.1Huong Test	Huong test	
ADC-test1	This is for the demonstration	
ALL BUT NO 3 way	ALL permissions but no 3 way	
ALL BUT NO FREE	All but free	
Admin - Crime Tip Modify	Crime Tip Modify Access Admin	✓
Admin - Crime Tip Read	Crime Tip Read Access Admin	✓
Admin - Informant Line Modify	Informant Line Modify Access Admin	✓
Admin - Informant Line Read	Informant Line Read Access Admin	✓
Admin - No Monitor	Administrator w/o Live Monitoring Rights	✓

The administrator may modify the initial access levels or create additional levels based on facility clearance objectives for each tool. SCP generates a user log with the user name, time of access, and modules accessed.

Create New Security Templates

Administrators can create new security templates based on unique requirements.

Name: Sheriff Access

Description: (200)

CONTROLLED AREA	CAN VIEW	CAN CHANGE
Admin - Security Templates	<input type="checkbox"/>	<input type="checkbox"/>
Admin - User Management	<input type="checkbox"/>	<input type="checkbox"/>

Create Cancel

Additional Password Policy Options

SCP provides flexible Password Policy options, enabling administrators to customize login security to meet their needs. Passwords can be configured by location, length, days to expire, and even the number of password cycles before password reuse. Additional

configuration options include reminders for password expiration and minutes of allowable inactivity before session timeout.

If a user does not change their password before expiration, the user must contact the site administrator for password reset. This administrator assigns a random password and requires the user to create a new password when they log in.

Password Configuration Options in SCP

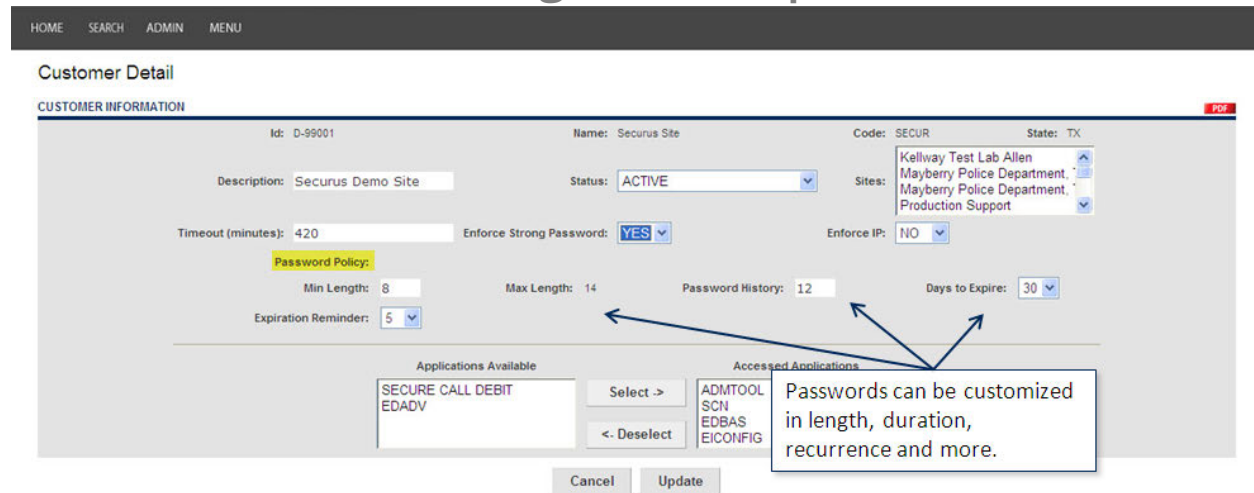

The screenshot displays the 'Customer Detail' page for 'Securus Site' (Id: D-99001). The 'Password Policy' section is highlighted in yellow and includes the following settings: Min Length: 8, Max Length: 14, Password History: 12, Days to Expire: 30, and Expiration Reminder: 5. The 'Enforce Strong Password' is set to 'YES' and 'Enforce IP' is set to 'NO'. A callout box with arrows pointing to the 'Min Length', 'Max Length', 'Password History', and 'Days to Expire' fields contains the text: 'Passwords can be customized in length, duration, recurrence and more.'

The "Forgot Your Password" feature available from the login screen offers online support for users who have forgotten their password. System security requires users to provide the correct answers to preset questions before their password can be reset. Once a new password is created, SCP emails confirmation to the address linked to the user ID.



Data Security

The Securus SCP is in a carrier-class data center that has some of the most comprehensive security measures in the telecommunications industry. Multiple layers of security control physical access to the Securus network facilities.

Security personnel maintain the following procedures for allowing entry into the data centers:

- Security personnel are on premise 24x7x365
- Cardkey reader (electronic badge) access for entry
- All persons having a business need to access company premises must carry identification badges at all times

- Man traps at each entry and exit point in the data center. Man traps use two sets of doors that both require electronic badge entry. The first set of doors must close before the second can open.

Access Procedures

All visitors, customers, contractors, and repair personnel must gain access from the security officer on duty.

Customers, contractors, repair personnel, maintenance personnel, and non-local employees can access buildings and critical areas only with an escort. Vendors may access buildings and critical areas only during working hours and also require an escort.

Certain ICS providers would like you to believe that Securus was “hacked” based on an article that appeared last November in *The Intercept*. After this article was published, Securus retained outside counsel to conduct an independent investigation of the allegations appearing in the article. Counsel’s investigation team included world renowned forensic experts.

After an exhaustive investigation, the team concluded that no system or database of Securus was “hacked” or otherwise unlawfully accessed, much less that inmate recordings or other data in a Securus system or database was unlawfully listened to, copied, read, or otherwise “stolen.” Rather, the investigators determined that the data/database at issue was on a third party platform over which Securus had absolutely no ownership or operational control.

Further, although this third party system was unlawfully accessed (by someone unlawfully obtaining an id and password to access the system), there is no evidence that inmate call recordings or other data were actually listened to, copied, read, or otherwise “stolen.” So it is manifestly false to claim that a Securus database or system was “hacked” and our data was “stolen.” No Securus system or database has ever been “hacked” or otherwise unlawfully accessed.

Securus takes the security and access to our software/application very seriously and hence have implemented one of the strongest controls in the industry. Securus access controls for all systems are audited for compliancy with the following accreditations/certification:

- SSAE16; (SOC1, SAS70): Statement on Standards for Attestation Engagements (SSAE) No. 16, Reporting on Controls at a Service Organization

- SOX: The Sarbanes–Oxley Act of 2002, is a United States federal law that set new or enhanced standards for all U.S. public company boards, management and public accounting firms.

The applicability and adherence to access policies are applied across all systems with regular frequency control (Daily, Weekly, Quarterly, Semi-annual, and Annual) and overall Security protocol process flow is audited on a yearly basis.

Our customer facing applications use a combination of Microsoft Active Directory and Databases for authorization and authentication controls. This combination of technologies helps us implement the above mentioned access controls seamlessly in our environment for customer peace of mind.

3.11.2 Jurisdiction

The vendor must guarantee DOCCS that it will not transport or make available physically, electronically, verbally or in any other form or manner, any data (either test or production) provided or produced under the contract that is awarded as a result of this RFP outside of the borders of the United States.

SECURUS HAS READ, AGREES AND WILL COMPLY WITH THIS REQUIREMENT.

3.11.3 Compliance

The vendor will comply with all the DOCCS' security policies and procedures and requirements as well as State security policies including, but not limited to, the NYS Enterprise Information Security Office (EISO). Information for this Security Policy is available at www.its.ny.gov/eiso/policies/security.

SECURUS HAS READ, AGREES AND WILL COMPLY WITH THIS REQUIREMENT.

3.11.4 Background Checks

The vendor's personnel must meet DOCCS' requirements for background checks and be subject to ongoing review to assure that staff continues to meet security screening standards.

SECURUS HAS READ, AGREES AND WILL COMPLY WITH THIS REQUIREMENT.

3.11.5 Information Security Breach

The vendor shall notify DOCCS immediately if it experiences any security breach that may cause DOCCS' data and/or customer's data to be corrupted or inappropriately accessed or used. Such notice shall occur within four (4) hours of any incident.

Provide a copy of your data security breach notification and response procedures.

SECURUS HAS READ, AGREES AND WILL COMPLY WITH THIS REQUIREMENT.

On intrusions, every incident is evaluated individually and appropriate action is taken based on severity. The escalation process is commensurate to the event, and each event is documented and communicated for review by senior management. Securus administrators adhere to our “Cyber Security Incident Response Plan” when Network anomalies are escalated. The plan is documented within our corporate Information Security policy. Breaches, should they occur, are handled in accordance with our “Data Breach Policy” which is also defined in the Master Information Security Policy.

3.12 Phase-Out Plan

~~The vendor shall provide DOCCS with a full explanation on how it will handle a transition situation at the end of the contract period. Any DOCCS owned equipment located outside DOCCS' sites, such as recording equipment and software, must be provided to the next contractor or DOCCS at no cost. DOCCS shall own all premised based equipment installed and all data. At DOCCS direction, the contractor must provide any and all data including call recordings to the new vendor or DOCCS.~~

The vendor shall provide DOCCS with a full explanation of how it will handle a transition to a succeeding vendor at the end of the contract period. The plan must describe how the vendor will 1) provide any and all data including call recordings to the succeeding vendor or DOCCS in a manner that will allow DOCCS to access individual recordings using the succeeding vendor's system; or 2) a mechanism that will allow DOCCS to search for and access individual recordings for up to one year after the transition is complete. The plan must also describe how "Flagged" call recordings, which are retained indefinitely, will be provided and/or made accessible to DOCCS following the transition to the succeeding vendor. The plan must also describe how the proposed transition plan will maintain the chain of custody of individual recordings, whether Flagged or not, should they be needed as evidence following the transition to the new system. Any DOCCS-owned equipment located outside DOCCS' sites, such as recording equipment and software, must be provided to the next contractor or DOCCS at no cost. DOCCS shall own all premised-based equipment installed and all data. (replaced by Addendum II)

SECURUS HAS READ, AGREES AND WILL COMPLY WITH THIS REQUIREMENT.

Securus intends to earn DOCCS business and trust, and establish a lasting relationship with DOCCS. If we are not fortunate enough to retain your business, we have a thorough phase-out plan that will make the transition as smooth as possible. A phase-out plan needs to take into consideration more than continuing to provide DOCCS with access to inmate call recordings. From an operational perspective, the plan needs to incorporate the migration of database information. Today's inmate calling platforms store a tremendous amount of

inmate information that is built over several years. If this information is not provided to the incoming provider, DOCCS will bear the burden of trying to gather the information.

Securus will provide all of the following information to the incoming vendor in an electronic format, such as Excel, PDF, CSV file, that will allow them to import the information to the respective platform.

Existing PIN list (active)

Existing PAN list

Global allowed list

Global blocked call list

Call restrictions by PIN, facility, housing unit, time of day, and day of week

Other inmate telephone system data as requested and directed by DOCCS

Securus' Secure Call Platform Command Center will continue to provide the DOCCS authorized staff access to the inmate recorded calls for a period of one year, and will work with the awarded vendor to facilitate access to "flagged" calls. Since the recordings will still reside in the Securus SCP system, the same chain of custody guarantee that Securus maintains during this contract will still be in place. There will no longer be a need to download tapes to removable media and hope that the chain of evidence is still valid.

3.13 Training

The vendor shall specify the training requirements and expected roles and responsibilities for all of DOCCS' ITS staff required for the planning, implementation and on-going operation of the ITS. The vendor shall provide all training at no cost to DOCCS.

The vendor will deliver the needed training in a manner, at a location and according to a schedule approved by DOCCS. All training will include proficiency testing and additional training will be provided at no additional cost until all participants achieve proficiency. The vendor will provide refresher training or training for new staff as needed at no cost.

List and describe all training, including the title, length, general content, and the proposed schedule for the training.

SECURUS HAS READ, AGREES AND WILL COMPLY WITH THIS REQUIREMENT.

Securus provides product training for all SCP features in the agreement with DOCCS. Experienced Securus employees conduct all training through online instructor-led classes or on-site, one-on-one and classroom training sessions at no cost. We deliver standard training using both hands-on experiences with your data and using instructor demonstrations to ensure each trainee understands all SCP functions.

Securus training programs enable facility staff to use all features the first day of installation. Since our products are web-based, after a two or three-hour training session, most facility staff can easily maneuver through the system's features.

In addition to standard training, Securus will develop an online training experience to meet the unique needs of your staff and facility. We offer separate classes focused on different agency functions such as investigations, live call monitoring, and system administration. Securus offers online instructor-led courses available twice a month throughout the year for product upgrades, new facility staff, or general refreshers. *Securus ongoing training ensures your staff always "stays on top" current and newly released SCP features.*

Continued Training Opportunities Through Bi-annual Investigative Technology Workshops

Securus recognizes the importance of keeping up with changes in technology. This proposal includes transportation, lodging and food for up to five (5) DOCCS staff to attend bi-annual Investigative Technology Workshops at our state-of-the-art Technology Center, located in Dallas, Texas. These workshops will not only enhance the skills and capabilities of staff; they can function as training and certification opportunities, as well. This is in addition to the on-going training and support provided throughout the contract term.

SCP Training Course Modules

Securus is committed to providing your staff with training that will maximize the potential of the features implemented at your facility. Training courses are offered in a user-friendly, task-oriented format to teach your staff what they need to know to do their job. We present courses in separate modules based on the types of duties officers tend to perform using the SCP inmate telephone system while focusing on the unique features of our applications.

The following table presents the standard SCP training course modules and associated learning objectives.

SCP Course Modules

Course Module	Objective
Getting Started	Logging in Navigating through the features Managing your password Contacting Technical Support for service calls
User Administration Activities	Creating and changing user accounts

	<ul style="list-style-type: none"> Defining a user's role and granting access permission Resetting a user's password Deactivating and/or deleting users Running user management reports
Inmate Administration Activities	<ul style="list-style-type: none"> Adding and changing inmate phone accounts Deactivating inmate phone accounts Setting up the phones to meet your requirements Using administrative reports
Monitoring Activities	<ul style="list-style-type: none"> Reviewing Call Detail Records (CDRs) Monitoring live calls Listening to recorded calls Using monitoring reports Saving calls and burning to CD
Investigation Activities	<ul style="list-style-type: none"> Using CDRs for investigations Recognizing trends in inmate activity Using other investigative tools to collect evidence "Digging" into the details
Super User Activities	<ul style="list-style-type: none"> Learning time-saving tips and tricks Discussing actual facility situations and turning evidence into intelligence Troubleshooting for operational and maintenance staff to minimize unnecessary service calls

SCP Online Help

Securus also provides online self-help available at all times from a convenient Help menu accessible through SCP. Trainees use this online application to find quick answers to their questions about SCP. Keyword searching offers immediate access to the information or users can follow the table of contents for a full learning experience. Step-by-step instructions are designed to help the user complete tasks.

Officers can print one topic or the entire help system if a full User Manual is preferred. Securus continuously upgrades and enhances SCP, so we recommend only printing the section needed to ensure all printed material is current.

The following figure illustrates the SCP Online help screen

- Account number (Of the officer)
- PIN (PIN number associated with an officer)
- Officer ID
- User Name (SCP user ID of the officer if he/she has one)
- First and Last Name
- Call Status
- Date and Time Range
- Results per page

Officer Check-In Report

Secure Call Platform Facility Routing Number: 99001

HOME SYSTEM MONITOR TOOLS ADMIN FACILITY PORTAL

MANAGEMENT LEVEL

Facility: Securus Demo Site Site: All Sites Phone Group: All Phone Groups Phone: All Phones

Officer Check In Messages Results

FILL IN SEARCH CRITERIA (* Indicate Required Fields)

(Use * for wild card / partial searches)

Account#: [] PIN: [] Officer ID: [] User Name: []

First Name: [] Last Name: [] Call Status: Complete

Results per page: 10

Start: 01/19/2010 00:00:00 End: 04/19/2011 23:59:59

Search Reset

12 Results PAGE 1 OF 2

SITE	PHONE LOC	NAME	USERNAME	ACCOUNT # / PIN	OFFICER ID	DUR	CALL STATUS	MESSAGE
Securus Demo Site	LP 7	Ken Burns	kburns	POC1123 5555	3838383	23 (s) 0.38(m)	complete	03-03-2010 10:11:43
Securus Demo Site	LP 7	Ken Burns	kburns	POC1123 5555	3838383	20 (s) 0.33(m)	complete	03-03-2010 17:03:58
Securus Demo Site	LP 7	Abe Smith		12346 12346	12346	18 (s) 0.32(m)	complete	03-03-2010 17:04:00
Securus Demo Site	LP 7	Lira User		12347 12347	12347	25 (s) 0.42(m)	complete	03-05-2010 10:35:11
Securus Demo Site	LP 7	Ken Burns	kburns	POC1123 5555	3838383	20 (s) 0.33(m)	complete	03-05-2010 10:35:57
Securus Demo Site	LP 7	Ken Burns	kburns	POC1123 5555	3838383	91 (s) 1.52(m)	complete	03-05-2010 10:49:22

Personal Allowed Number Frequency Report

The Personal Allowed Number (PAN) Frequency Report shows phone numbers that appear in multiple PAN lists. Users enter threshold numbers to define search criteria. For example, a threshold of "four" will show phone numbers that appear on more than four PAN lists.

Personal Allowed Number Frequency Detail Report

The PAN Frequency Detail Report allows users to search PAN lists to see phone numbers that appear more than once.

Personal Allowed Number Frequency Report

The screenshot displays the 'Secure Call Platform' interface. At the top, there are navigation tabs: HOME, SYSTEM, MONITOR, TOOLS, ADMIN, and FACILITY PORTAL. Below this is a 'Modify Facility' section with 'MANAGEMENT LEVEL' and 'Facility' dropdowns. The main section is 'PAN Frequency Search', which includes a 'FILL IN SEARCH CRITERIA' form with a 'Threshold' set to 4 and buttons for Search, EXCEL, PDF, CSV, and Reset. Below the search form, there are 70 results in a table with columns for SITE, DIAL ID #, and FREQUENCY. Two results are highlighted with arrows pointing to empty boxes. Below this is a 'PAN Frequency Detail Search' section with a 'FILL IN SEARCH CRITERIA' form for Country Code (1) and State Number (9722770596), and buttons for Search, EXCEL, PDF, CSV, and Reset. Below the detail search form, there are 16 results in a table with columns for SITE, DIAL ID #, NAME, and PIN. Arrows point from the highlighted results in the first table to the corresponding rows in the second table.

SITE	DIAL ID #	FREQUENCY
Securus Demo Site	(1) 9722770596	16
Securus Demo Site	(1) 9722770556	14

SITE	DIAL ID #	NAME	PIN
Securus Demo Site	(1) 9722770596	Pblact08 Pmldia08 Hinet08	99110008
Securus Demo Site	(1) 9722770596	TLAST02 THldie02 Trinet02	1110002
Securus Demo Site	(1) 9722770596	Test QA	992009
Securus Demo Site	(1) 9722770596	Test Gerald	0343 0343

CrimeTIP Report

The CrimeTIP report allows users to search for and listen to any anonymous crime tip messages left by inmates, outside parties, or officer replies. Search criteria include:

- Mail Box ID
- Call Type
- Date / Time Range
- Results per page

CrimeTIP Report

The screenshot displays the 'Secure Call Platform' interface. At the top, there is a navigation menu with options: HOME, SYSTEM, MONITOR, TOOLS, ADMIN, FACILITY PORTAL. The 'Facility Routing Number' is 99001. Below the navigation, there is a 'MANAGEMENT LEVEL' section with 'Facility' and 'Site' dropdowns. The 'TIPS Search' section includes a 'FILL IN SEARCH CRITERIA' section with a note: '(Use * for wild card / partial approach)'. Search filters include 'Mail Box ID', 'Call Type' (set to ALL), 'Date Criteria' (set to Date/Time Range), 'Results Per Page' (set to 10), 'Start Date/Time' (01/29/2011 00:00:00), and 'End Date/Time' (04/26/2011 23:59:59). There are 'Search' and 'Reset' buttons. Below the search filters, it shows '35 Results' and 'PAGE 4 OF 4'. A table of results is displayed with columns: SITE, PORT LOG, REPLY MAILBOXID, CALL TYPE, START, END, and DUR (S). The table contains five rows of data, all from 'Securus Demo Site' and 'je test 4', with 'Offender' as the call type. The start and end times vary, and the duration is listed in seconds.

SITE	PORT LOG	REPLY MAILBOXID	CALL TYPE	START	END	DUR (S)
Securus Demo Site	je test 4		Offender	04-19-2011 16:46:36	04-19-2011 16:47:01	0
Securus Demo Site	je test 4		Offender	04-19-2011 16:49:39	04-19-2011 16:50:23	24
Securus Demo Site	je test 4		Offender	04-21-2011 01:45:50	04-21-2011 01:46:42	32
Securus Demo Site	je test 4		Offender	04-21-2011 01:51:02	04-21-2011 01:52:00	57
Securus Demo Site	je test 4		Offender	04-21-2011 01:53:34	04-21-2011 01:54:03	29

Informant Line Report

The Informant Line Report allows users to search for calls placed to the informant line and distinguish these calls from regular inmate calls. Search criteria include:

- Site name from which the call originated
- Phone location as labeled in the system
- Facility code
- Dialed number
- Start date/time
- End date/time
- Duration of call
- Offender Account Number
- Offender PIN
- Prepaid card number if used
- Offender first, middle, and last name
- Type of call (voice mail, person call, prepaid call, debit call)
- Status of call (complete/incomplete)
- Reason for call termination

- Reason for block
- Call properties (watched number, RCF detected, three-way attempt, private number)
- Destination zone (local, intrastate, interstate, international)
- Desired results per page

Informant Line Report

Secure Call Platform Facility Routing Number: 99001

HOME SYSTEM MONITOR TOOLS ADMIN FACILITY PORTAL

MANAGEMENT LEVEL
 Facility: Securus Demo Site
 Phone Group: All Sites
 Phone: All Phones

Informant Line Call Records Search

FILL IN SEARCH CRITERIA (* indicates required fields)
 (Use * for wild card / partial searches)

Country Code: [] Dislod Number: [] Destination Zone: --ALL-- International:
 Custody Account #: [] FBI #: [] Prepaid Account #: [] Watched:
 First Name: [] Last Name: [] Private:
 Termination Category: --ALL-- Call Status: Complete Search: Three:
 Date Criteria: Date/Time Range Results Per Page: 100 Voice Biometrics:
 Start Date/Time: 04/21/2011 00:00:00 End Date/Time: 04/29/2011 23:59:59 RCF:

Search Reset

2 Results PAGE 1 OF 1

MP	MPID	MPID LOC	CALLER #	EVENT	DIR	DIR	CALL	CALL # FBI	PREPAID ACCT#	NAME	CALL STATUS	TIME CAT	CALL PROPERTIES
		Securus Demo Site	LP 17 (1) UNLISTED Local	04-21-2011 02:04:40	04-21-2011 02:04:59	19 (s) 0.30 (m)					complete	Called party hangup	
		Securus Demo Site	LP 17 (1) 9732770529 Local	04-21-2011 02:17:30	04-21-2011 02:18:02	12 (s) 0.2 (m)	00343				complete	Called party hangup	

Secure Call Platform Debit Report

The SCP Debit Report allows users to:

- Query Offender Debit/Prepaid call detail records (CDRs) by user-specified criteria
- View all debits and credits that occurred during a specific period for an individual inmate, for all inmates in a facility, or for all facilities

Secure Call Platform Debit Report

Secure Call Platform

HOME SYSTEM MONITOR TOOLS ADMIN FACILITY PORTAL

MANAGEMENT LEVEL
Facility: Security Demo Site Phone Group: All Phone Groups Phone: All Phones

SCP Debit Report Search
(Negative numbers will be displayed in parenthesis)

FILL IN SEARCH CRITERIA (*Inmate Required Fields)

(Use * for wild card / partial searches)

Inmate First Name: Last Name: Custody Account #: PIN:
User Name: User Comments: Description:
Type: --ALL-- Amount: --ALL-- Exclude Automated Process:

Note: Please limit search range to no more than 31 days
Start: 10/19/2010 00:00:00 End: 11/18/2010 23:59:59

Search Reset

Site	Account # / PIN	Inmate First/Last	Type	Amount	Date/Time (in Central Time)	User	Reference #	Description	Comment
Security Demo Site	0343 0343	Sec99 Test	Credit	\$100.00	11/18/2010 00:00:00	GAJIN@SCC0707L	2010201002034-0343	Site Issued Credit	
Security Demo Site	10280101R-10280101-3850	TR LOCALS	Credit	\$100.01	10/20/2010 11:12:28	41301@SCC0707L	20101020111024-1028010	Site Issued Credit	
TOTALS									
172.16.32.40									
				Action Type	Quantity	Amount			
				Payment	0	\$0.00			
				Credit	2	\$200.01			
				Debit	0	\$0.00			
					2	\$200.01			

Export capabilities for reports

Authorized users have fast and convenient access to SCP reports. They can save, retrieve, and share reports in the following file formats:

- Adobe® PDF
- Microsoft® Excel
- Comma Separated (CSV)

Users can also save reports to multiple destinations or upload data from the report into their other databases for further analysis.

Custom Reports

The Securus Secure Calling Platform (SCP) is very flexible and easy to use and allows the user to create almost limitless reporting. Should customized reports be needed, Securus

will provide them to DOCCS at no charge except in those cases where the customized report would require a significant allocation of resources or material changes to Securus systems and procedures.

In the small number of instances where development is needed (e.g. capturing additional information from other systems), Securus will provide the development free of charge unless the request involves significant cost to Securus. In such cases DOCCS will be given the option to pay for the additional services without markup by Securus.

Please see section/tab – REQUESTED DOCUMENTATION for a complete list of reports. (page 531)

Please see 4.2.8 for a sample bill reflecting monthly billing for individual lines, groups of lines and the master account. (page 419)

END OF SECTION 3: TECHNICAL REQUIREMENTS

4 Customer Service

4.1 Support Services for DOCCS

4.1.1 Principal Technical Support Representatives

The vendor shall assign primary and secondary representatives who will be knowledgeable of DOCCS' operational and support requirements and service levels and who will act as the DOCCS' principal liaisons for both Technical and Customer Support and be available 24 hours per day. When the primary liaison is unavailable, the secondary shall assume those duties. DOCCS prefers that the primary contact be resident in New York State. Within 14 days of notification of the tentative contract award, the selected bidder must provide résumés of the proposed representatives for DOCCS approval. The State reserves the right to require additional information, including direct interviews and demonstrations, to facilitate a determination of the proposed representatives' qualifications. DOCCS reserves the right to accept or reject any proposed candidates for this position.

SECURUS HAS READ, AGREES AND WILL COMPLY WITH THIS REQUIREMENT.

4.1.2 Toll-Free Access

The vendor must provide DOCCS with toll-free access for technical support that is available 24 hours per day, 365 days per year. Customer support access to knowledgeable personnel must be available within ten (10) minutes of the contact initiation by DOCCS.

SECURUS HAS READ, AGREES AND WILL COMPLY WITH THIS REQUIREMENT.

4.1.3 DOCCS' Authorized Representatives

DOCCS will establish an authorized list of individuals or titles who have the authority to open trouble tickets and request maintenance dispatch or support services. The vendor will only act on the request of an authorized individual on the list.

SECURUS HAS READ, AGREES AND WILL COMPLY WITH THIS REQUIREMENT.

4.1.4 Gate Clearance

The vendor shall be responsible for establishing all gate clearances in conformance with DOCCS' policies and procedures for on-site visits.

SECURUS HAS READ, AGREES AND WILL COMPLY WITH THIS REQUIREMENT.

4.1.5 Ticketing System

The vendor shall utilize an automated ticketing system to log, track, manage and assure appropriate response to all calls for support. DOCCS and/or its representatives shall be provided real-time access to this system including the ability to create new tickets and run reports on service tickets related to services provided to DOCCS. Reporting capabilities associated with this system must comply with Section 3.15 above. The

vendor must be prepared to work with DOCCS to integrate the proposed ticketing system with the trouble ticket system utilized by DOCCS.

Describe how this system will provide the required functions and explain the system's capabilities. Include details as to what level of visibility and access DOCCS will have.

SECURUS HAS READ, AGREES AND WILL COMPLY WITH THIS REQUIREMENT.

Event Tracking System

The Securus event tracking system logs, tracks, manages, and assures an appropriate response to all service requests. The service request generates a unique trouble ticket number linked to each facility's service history and provides real-time updates. Each ticket has a priority level assignment, which drives diagnosis and response processes. The support technician performs initial problem diagnosis and isolation procedures, determines the nature of the problem, and resolves the problem or engages the appropriate party for problem resolution.

The TSC maintains ownership of all service requests and responsibility for the escalation and update functions. Every effort is made to resolve problems remotely and within the framework of resolution timeframes. However, if the problem requires on-site service, a technician is dispatched. Securus will contact the facility to arrange for the on-site service at the convenience of the facility.

DOCCS facilities can also open and track trouble tickets through our convenient facility portal.

Facility Portal

Securus provides customer facilities with one of the only anywhere, anytime, single-point-of-access customer portals in the industry. Approved users can access all calling activity, including all call detail reports. The Facility Portal also serves as the user interface to the Securus electronic trouble ticket system. Authorized users can initiate trouble tickets for repairs, track the real-time ticket status, and generate current and historical reports of trouble tickets with the Facility Portal. The facility Portal generates a tracking number for each ticket opened. Users can search for service tickets by ticket number or by date search. All updates are sent electronically in real-time to the originator of the ticket, as well as to DOCCS designee.

Open Service Ticket

FRIENDS & FAMILY **CORRECTIONAL FACILITIES** ABOUT US CAREERS CONTACT US

Facility Portal

Facility Name

Dashboard
Portal Manager
Commissions Reports
General Reports
Order Materials
Downloads & User Guide
Service Center
Your Tickets
Create A Ticket
Date Search

Search Tickets

Create Service Ticket

Site: Facility Name

Problem Category: Please Choose a Category

Suggested Priority: Please Choose a Category

Problem Description: Full Outage
Inmate Can't Place Call
Other
Partial Outage
Password Reset
Phone/Equipment Replacement
PIN Reset
SCP User Interface Question

Submit Ticket

Manage Your Service Tickets

FRIENDS & FAMILY **CORRECTIONAL FACILITIES** ABOUT US CAREERS CONTACT US

Facility Portal

Facility Name

Dashboard
Portal Manager
Commissions Reports
General Reports
Order Materials
Downloads & User Guide
Service Center
Your Tickets
Create A Ticket
Date Search

Search Tickets

Help
Secure Call Platform
Log-Out

Your Service Tickets

SITE NAME	TICKET #	DESCRIPTION	LAST UPDATED	STATUS
Facility Name	13802698	Div 11 VB enrollments	2011-08-16 09:56:04	Closed
Facility Name	13799289	Voice Biometrics - the customer is enrolling/re-enrolling inmates in VB at Division 11...	2011-08-12 11:06:10	Closed
Facility Name	13792501	Report Request: Calls completed in 2008 from Division 1, Tier B-4 Call period is 9/1...	2011-08-05 15:19:43	Closed
Facility Name	13783054	customer reports that he creates an iso image to burn to DVD and when image was downlo...	2011-07-29 10:24:54	Closed
Facility Name	13782536	Voice Biometric - Re-enrollments the customer is doing re-enrollments of inmates at t...	2011-07-28 11:10:58	Closed

1234
Total Tickets

Clicking the ticket number in the service history generates a report with ticket detail. Users can review all the notes and the final resolution of any closed ticket at any time. If the ticket is currently open, users can create a new journal note. Consent to close a ticket can also be performed using the notes section.

Example of ticket detail:

Ticket Detail

The screenshot displays the Facility Portal interface. At the top, there is a navigation bar with links for 'FRIENDS & FAMILY', 'CORRECTIONAL FACILITIES', 'ABOUT US', 'CAREERS', and 'CONTACT US'. Below this is the 'Facility Portal' logo. On the left, a sidebar lists various 'Marketing' options: Dashboard, Portal Manager, Reports, Order Materials, Downloads & User Guide, Service Center, Your Tickets, Create A Ticket, Date Search, and Search Tickets. The main content area is titled 'Ticket Details #13529104'. It features a 'TICKET #13529104' section with the following details: Call Description: female pod 11 block phone not working, Ticket Priority: 3, Ticket Status: Closed, Date Opened: 12/29/2010 8:14:24 AM, Last Update: 12/29/2010 8:51:24 AM, and Solution Description: reset tips. Below this is a 'JOURNAL NOTE (TIME S)' table with two entries:

JOURNAL NOTE (TIME S)		
lgreathouse	12/29/2010 8:40:03 AM	Issue Resolved - Waiting for Customer Approval
lgreathouse	12/29/2010 8:39:53 AM	Authorization Obtained from: Hogan

At the bottom of the ticket details section, there is a button labeled 'Create A New Journal Note'.

Facility Portal Reports

DOCCS users can view or download several reports from the Facility Portal:

- **Ticket Detail** – Clicking the ticket number in the service history generates a report with ticket detail.
- **Calling Activity Report** – This report provides details on the number and type of calls made from a telephone number at the facility.
- **Call Type Summary Report** – This report provides details on the number and type of calls made from a specific telephone number at the facility. Calls will be broken down by local, intraLATA, interLATA and interstate.
- **Daily Call Volume Snapshot** – This report shows a daily snapshot of calls and minutes compared to the daily average
- **Monthly Call Frequency Chart** – This chart details the most frequently called numbers from the facility.
- **Preliminary Monthly Revenue Report** – This report details all calls, minutes and revenue for a specific date range.

- **Preliminary Daily Revenue** – This report details all calls, minutes, and revenue for a specific date.
- **Investigation Tool** – This tool allows for tracking of a specific dialed number from any of the approximately 2,600 facilities serviced by Securus.

4.1.6 DOCCS' Access to Customer Information

The vendor shall provide DOCCS and/or its representatives with secure online, real-time access to all customer information regarding account status and history.

Describe how this function will be provided, and explain its capabilities. Include details as to what level of visibility, access, and reporting DOCCS' ITS staff will have.

SECURUS HAS READ, AGREES AND WILL COMPLY WITH THIS REQUIREMENT.

Securus will provide DOCCS and/or its representatives with secure online, real-time access to all customer information regarding account status and history that is allowed by law.

Securus will provide DOCCS with SCP access to inmate debit account status, call charges, history and call data, online and in real-time. Securus will also provide DOCCS access to the Facility Portal for additional call detail information.

Securus will provide other information to DOCCS as requested and as allowed by law.

Please see 4.2.8 to review a sample bill reflecting monthly billing for individual lines, groups of lines and the master account. (page 419)

Standard Reports Available through SCP User Interface

The Securus Secure Call Platform (SCP) has a dedicated report writer that provides investigative information based on the call detail records. This sophisticated reporting tool provides a reporting interface into all calling activities.

Users can search and analyze call details on all calls placed from each inmate telephone through SCP. These details include date, time, duration, telephone number, origination, destination, inmate ID, termination reason, and more. SCP retains call details on all call attempts. Users can customize the standard reports by varying search criteria, such as date range, facility, or call length.

SCP provides standard reports with parameter fields that allow the user to define the information content of each report based on the following criteria options:

- Per phone, per location, and per offender
- Destination number (partial or full number entry)
- Date and time range
- Call frequency
- Call type (completed, incomplete, blocked)
- Number restriction and/or status assignment
- Personal allowed number cross-referencing
- Graphical display of call fluctuation
- Broad search with no data entry
- Suspected fraudulent call activity
- Offender name
- Offender PIN (if used) and/or account number
- Prepaid calling card number
- Destination zone (local, interLATA, interstate, intraLATA, international)

The Investigative Reports section compiles data and opens the information in a report format, on the workstation monitor. Investigative Reports provides multiple functions for call playback and copying call recordings to remote media. Authorized personnel can use this unique application to generate a report even when only a little information is available.

A full set of reports that administrative users need daily, as well as a full set of investigative reports, makes Securus' Standard Reports generator anything but standard.

Call Detail Report

The Call Detail Report (CDR) provides investigators an intuitive and user-friendly report to view or search virtually anything related to an inmate call, including:

- Site name from which the call originated
- Phone location as labeled in the system
- Facility code
- Dialed number
- Start date/time
- End date/time
- Duration of call
- Inmate Account Number
- Inmate PIN
- Prepaid card number if used

- Inmate first, middle, and last name
- Type of call (voice mail, person call, prepaid call, debit call)
- Status of call (complete/incomplete)
- Reason for call termination
- Reason for block
- Call properties (watched number, RCF detected, three-way attempt, private number)
- Destination zone
- Desired results per page

The Securus Secure Calling Platform (SCP) is very flexible and easy to use and allows the user to create almost limitless reporting. Should customized reports be needed, Securus will provide them to DOCCS at no charge except in those cases where the customized report would require a significant allocation of resources or material changes to Securus systems and procedures.

In the small number of instances where development is needed (e.g. capturing additional information from other systems), Securus will provide the development free of charge unless the request involves significant cost to Securus. In such cases DOCCS will be given the option to pay for the additional services without markup by Securus.

The Securus Secure Call Platform (SCP) retains call detail records on all call attempts. Authorized users can quickly run reports to spot calling trends, assess monitoring efforts, investigate suspicious activities, and manage phone usage.

Users can customize reports by changing search criteria such as date, time, call duration, telephone number, originating telephone, destination, inmate ID, termination reason, and much more.

The following steps show the ease of producing valuable, customized reports:

1. Place the cursor over Tools. A drop down menu will appear.
2. Move the cursor over Reports to see a menu of standard reports.
3. Click on the type of report you want. SCP will display the appropriate fields associated with that report.
4. Verify the correct Management Level is displayed or make changes as necessary. (This setting allows you to select the facilities, sites, phone groups, or phones you want to search.)
5. Enter your search criteria in the appropriate fields and click Search.

The records matching the search criteria will display. With a single click, the data can be instantly exported to Excel, CSV (Comma Separated Values), or Adobe PDF format.

Users will be able to sort on any of the following data elements.

Site	Agency Type	Promotional Call
Phone Location	Call Type	Text Call
Country Code	Call Status	Language
Dialed Number	Termination Category	DTMF Detection
Start Date/Time	Block Reason	DTMF Digits
End Date/Time	Privacy	Text2Connect Call
Duration	Watched	Prepaid
Account #	International	First Name
PIN	3-way Detected	Promotional Call
Continuous Voice Verification	Remote Call Forward Detected	Voice Biometrics
		Amount

The resulting report can easily be saved, printed out, or emailed to others.

Selecting a Report to Run

Secure Call Platform

The screenshot displays the 'Secure Call Platform' interface, specifically the 'Call Detail Records Search' section. The interface is organized into several panels:

- Navigation:** HOME, SYSTEM, MONITOR, TOOLS (selected), ADMIN, FACILITY PORTAL.
- Management Level:** Facility (Securus Demo Site).
- Search Criteria (FILL IN SEARCH CRITERIA):**
 - Country Code: []
 - Custody Account #: []
 - First Name: []
 - Termination Category: -- ALL --
 - Call Type: -- ALL --
 - Text2Connect: -- ALL --
 - Search Notes:
 - Tracker #: []
 - Alternate ID: []
 - Inmate Grouping: []
 - Date Criteria: Date/Time Range
 - Start: 02/16/2016 00:00:00
 - End: 02/16/2016 23:59:59
 - Results Per Page: 100
- Report Selection (THREADS):**
 - Reports - Saved Searches
 - BNA Lookup
 - Call Detail
 - Call Frequency
 - Call Tracker
 - Hourly Usage
 - Informant Line Report
 - Emergency Call Report
 - Covert Alert CDR
 - TIPS
 - Officer Check-In
 - PAN Frequency
 - PAN Frequency Detail
 - SCP Debit
 - CVV Configuration
 - Investigator Pro
 - RCFD Action Configuration
 - PAN Management
 - Word Spotting Report
- Advanced Search Fields:**
 - Dialed Number: []
 - Destination Zone: -- ALL --
 - International:
 - Watched:
 - Private:
 - 3-way:
 - Voice Biometrics:
 - Continuous Voice Verifications:
 - Wireless:
 - RCF:
 - AIS VoiceMail:
 - Live Connect:
 - Include Test Calls? No (selected) / Yes
 - Blocked Reason: -- ALL --
 - Call Status: Complete
 - Prepaid Account #: []
 - Agency Type: -- ALL --
 - Note Type: -- ALL --
- Actions:** Search, Save Criteria, EXCEL, PDF, CSV, Reset

4.1.7 Court Evidence and Expert Witness Testimony

The vendor shall provide verification that its methods and procedures meet accepted legal standards for chain of evidence in legal proceedings. At no cost to DOCCS, the vendor shall provide affidavits as required throughout the term of the contract, support any legal proceedings, and provide expert witness testimony as needed. In the last five (5) years DOCCS has experienced approximately ten (10) incidents requiring expert witness services.

SECURUS HAS READ, AGREES AND WILL COMPLY WITH THIS REQUIREMENT.

The Securus Secure Calling Platform (SCP) provides a patented method for ensuring the authenticity of inmate call recordings made through the platform. This security feature—the Chain of Evidence—is a key component of SCP and is automatically included in all installations. The Chain of Evidence prevents tampering with the call detail record and call recording. SCP encrypts, time-stamps, and verifies the authenticity of each recording.

SCP meets or exceeds the Rules of Evidence used in state and federal courts for the admissibility and authenticity required in a court of law.

In addition to the Chain of Evidence provided through SCP, Securus will provide expert staff to testify, at no cost to DOCCS, to the authenticity of the call recordings made on SCP.

Chain of Evidence

A phone call made on the Securus SCP creates a record, known as a call detail record (CDR), which includes—at a minimum—the following information:

- Customer name
- Facility name
- Originating station
- Destination number
- Start and stop time of the call
- PIN, if used by the facility

This information provides context information about the call. It is this context that differentiates a typical recording from one that can survive an evidentiary challenge to its authenticity. SCP combines this contextual information with the audio data in memory and writes the information to disk as a continuous data stream. It is not possible to modify the recording after recording to disk, and each recording contains the critical information about the authenticity of the data.

Storing this data in one combined unit creates a strong audit trail for identifying and proving the origin of the recorded call.

Creating the Audio Data

The recording process starts as soon as the called party answers the phone. This provides a record of the entire interaction between the SCP and the called party before the called party accepts the call. This interaction includes everything the called party says and all voice-over announcements, including the following information:

- Location of the originating call
- Inmate name
- Call rates
- Call acceptance
- Notification messages, such as the standard announcement that the call is subject to monitoring and recording

The recording is “complete” in real time and does not depend on the inmate and called party ending the call to have a “header” or other information written into the CDR. This feature is significant because the recording package is constructed real-time throughout the call and is un-editable, or locked, with all of the required data to identify the call. This guarantees that any recording produced for legal purposes is the original data (recording and call details) and cannot be modified.

Downloading Calls as Evidence

SCP allows authorized users to copy recorded conversations to any external media device connected to the user’s PC, such as CD, DVD, mp3 player, or USB drive. This feature facilitates easy sharing of recordings for investigative or court purposes. To maintain the accuracy of data and recordings during downloading and copying, SCP stores the files—both audio and CDR information—embedded within an industry-standard read-only format that prevents the possibility of tampering.

“I estimate that I request phone records for eight out of every ten subjects I investigate, and of the 100 subjects that I have helped convict over the past four years, probably half of those were because of telephone recordings provided by the Securus platform. Securus has been so successful in assisting with my cases that the US Attorney’s Office has asked me to get inmate calls for all cases.”

- *Master Police Detective Michael Wachsmuth, a Tactical Field Officer working with the Alcohol, Tobacco, and Firearms division of the Federal Justice Department.*

4.2 Support Services for Customers

DOCCS requires that the vendor provide account holders with responsible, reliable customer service and support as outlined herein. The vendor shall utilize an automated ticketing system to log, track, manage, and assure appropriate response to all calls for support from Customers. Reporting capabilities associated with this system must comply with Section 3.15 above.

Describe how this system will provide the required functions and explain the system's capabilities. Include details as to what level of visibility and access DOCCS' ITS staff will have.

SECURUS HAS READ, AGREES AND WILL COMPLY WITH THIS REQUIREMENT.

Securus' Oracle System, RightNow, maintains all Family & Friend records. Family & Friend records are not managed at the site level but at the Family & Friend Billing Telephone Number or Securus Internal account number. 90% of Family & Friend issues are fixed within a First Call Resolution. The remaining 10% of issues not resolved via First Call typically handled within 3 to 4 business days. Due to PCI compliance Family & Friend account information is not available for sites to access.

The Securus Best-in-Class Service Offering

The Securus product offering is like no other in the industry. Through our robust platforms, we offer more products and investigative applications than any of our competitors. The list below highlights a selection of Securus' comprehensive offering:

- Inmate identification: biometric and/or security code validation
- Calls on a prepaid or collect basis to friends and family members
- Identity authentication of called party
- Call restriction to certain parties (e.g., judges, jurors, witnesses, and victims)
- Detection and restriction of unauthorized call forwarding
- Real-time call monitoring capabilities
- Real-time credit quality assessment of called party
- Interface capabilities to many commissary and/or jail management systems

Over the past 20 years, Securus has spent more than \$100 million and devoted 300,000 man-hours developing an advanced, packet-based network platform that provides many cost and service advantages for our customers. We have transitioned nearly 2,600 facilities to this advanced platform from inferior, legacy, Premise-Based systems that many of our competitors continue to use.

The Securus calling systems include:

<p>SCA Architecture (SCA)</p>	<p>Serves as the backbone of the Securus platform, which results in significantly lower operating and capital costs through its implementation</p> <p>Comprises a robust data repository housing multiple data marts that each hold billions of bytes of stored information gathered from multiple sources</p> <p>Delivers an intelligent retrieval system that retrieves and processes user requests through a cross-application, cross data-mart retrieval process</p>
<p>Secure Call Platform (SCP)</p>	<p>Serves correctional facilities as well as inmates, friends, and family members</p> <p>Offers networking functions, robust system and application stability and redundancy, heightened security features, user auditing, and password-specific utilities</p> <p>Provides a proprietary, packet-based centralized calling platform widely recognized as the best in the industry</p>
<p>Secure Connect Network (SCN)</p>	<p>Provides a packet-based, digital transmission system for all communications transport</p> <p>Allows the Securus calling platform to provide real-time turn-on/turn-off flexibility for most system features, 24x7x365 offsite monitoring, immediate system upgrades, and repairs from one central location</p>
<p>SCP User Interface</p>	<p>Provides a single-point, easy-to-use user interface to all programs, applications, and services</p>
<p>Prepaid Calling Programs</p>	<p>Offers calling services to facilities or their commissaries who then sell directly to the inmates.</p> <ul style="list-style-type: none"> ○ Prepaid calling cards used by inmates ○ Domestic and international ○ Paperless, card-free prepaid calling solution for inmates (debit services)
<p>Securus Correctional Billing Services</p>	<p>Provides nationwide customer care and billing center dedicated to inmates' family members and friends, 24 hours per day, 365 days per year</p> <p>Offers multiple payment options, including prepayment of charges, remittance directly to the local phone company, and credit card payments</p>
<p>Additional Products and Services</p>	<p>Automated Information Services (AIS)</p> <p>Email and voice mail services</p> <p>Covert Alert services</p> <p>Voice biometric products</p>

Sophisticated investigative tools
Jail management software
Video visitation
Contraband cell phone control

Securus retains more than 98% of customers – the best in the industry – because we are committed to providing the best customer service to family members and friends of inmates. Securus spent more than \$2 million to build an in-sourced customer call center staffed by Securus employees rather than the poorly managed and highly inferior foreign call centers that our largest competitors use. Lastly, Securus Field Service Technicians are Securus employees (not contractors) who follow the strict guidelines our correctional facility customers demand. Many of our competitors use third-party contractors who might have other priorities.

Inmate friends and family members can manage all phone services, video visitation services, and email services from www.securusutech.net/friends or www.securustechnologies.com.



The screenshot displays the top portion of the Securus Technologies website. On the left is the Securus Technologies logo. To its right is a login form with fields for 'Email Address' (containing the placeholder 'Type your email address') and 'Password'. Below the email field is a 'Remember Me' checkbox. To the right of the password field are links for 'Login Assistance' and 'Enroll Now'. A green 'LOGIN' button is positioned to the right of the password field. Below the login form is a dark navigation bar with links: Home, Phone Services, Video Services, Jail Voicemail, Money Transfer, Email Services, Facilities We Serve, FCC, Customer Care, and Live Chat. Below the navigation bar is a large banner featuring a photograph of a smiling woman and two children. The banner text reads 'Welcome to SECURUS TECHNOLOGIES connecting what matters™' with a blue 'Get Started Now!' button.

4.2.1 Toll-Free Access

The vendor shall provide toll-free telephone access to knowledgeable customer service staff for at least the normal inmate telephone operating hours, which are currently 7:00 a.m. to 11:00p.m. ET, 365 days per year. All customer service representatives must have access to up-to- date customer account information including at a minimum billing, payment and blocked call status and history.

SECURUS HAS READ, AGREES AND WILL COMPLY WITH THIS REQUIREMENT.

Securus is unique among its national competitors in offering an in-sourced, US-based call center to provide customer service to friends and family members of inmates. Our 200+ seat call center employs customer service representatives who are Securus employees, trained and managed to Securus' standards.

Live agent support is available to friends and family members seven days a week, 24 hours a day, and 365 days a year.

4.2.2 Executive Order Number 26

Bidders should review this executive order prior to submitting proposals. You may access the executive order on the Governor's Web site: [No.26 STATEWIDE LANGUAGE ACCESS POLICY](#) In the event that translation/interpretation services are required for languages other than the Spanish language, the selected Contractor must agree to comply with any requests by DOCCS to provide documents or other assistance to allow for translation or interpretation to be conducted.

SECURUS HAS READ, AGREES AND WILL COMPLY WITH THIS REQUIREMENT.

4.2.3 Customer Account Access

The vendor shall provide customers with secure web-based access to account information including billing, payment and blocked call status and history. Customers should be provided the capability to securely add funds to their pre-paid account online. The vendor must transfer all existing accounts at no cost to the account holders.

Describe how your solution provides this functionality and explain its capabilities.

SECURUS HAS READ, AGREES AND WILL COMPLY WITH THIS REQUIREMENT.

Inmate friends and family members can manage all phone services, and email services from www.secrusutech.net/friends or www.securustechnologies.com. There is no charge for customers to transfer accounts to Securus.



Welcome to
SECURUS TECHNOLOGIES
connecting what matters™

[Get Started Now!](#)

Securus Video Visitation
allows you to visit from
ANYWHERE!!
Download the Securus
Video Visit App Today!

[Download on the Google Play](#) [Download on the App Store](#)

Phone Services

ADVANCE CONNECT

Phone Number: (972) 922-8823
Account Number: 12454515
Available Funds: **\$0.00**

ADD FUNDS

- Manage Account** ▾
- Call Details ▶
- Transaction Details ▶
- Block & Unblock Calls ▶

Account Status:
Account Relation: Owner
Want to ensure you always have funds?
Sign up for AutoPay or TextPay by clicking [here](#).

Manage Account

- Authorized Phone Numbers [Edit](#)
- Securus Alerts [Edit](#)
- Account Statement [Download](#)
- AutoPay/TextPay Enrollment [Enroll](#)
- [Close Account](#)

4.2.4 Customer Outreach

DOCCS meets periodically with inmate advocacy groups to discuss a variety of issues. The vendor's representative(s) will be required to attend such meetings to discuss ITS related issues.

SECURUS HAS READ, AGREES AND WILL COMPLY WITH THIS REQUIREMENT.

4.2.5 Call Blocking

The vendor must notify customers prior to initiating a block on collect calls. If a collect call account is in arrears and the vendor applies a block, the vendor must provide an opportunity for the customer to establish a pre-pay account.

Provide details on how this will occur, at a minimum provide details for the following:

- **The steps initiated to contact the customer and describe how many and what types of attempts will be made**
- **What procedures are followed**
- **The timeframes between each step in the process**
- **The specific reasons why a call is blocked**
- **Any automatic processes that trigger a block**
- **What are the procedures and timeframes for customers to remove a block**

SECURUS HAS READ, AGREES AND WILL COMPLY WITH THIS REQUIREMENT.

Securus sends low balance AdvanceConnect account notifications via text to a mobile device or an email address provided by the user. Securus also sends direct bill invoice due notifications via text or email.

Securus also has outgoing message phone dialers for "low balance" and "invoice due" notifications. When they receive one of these calls, users can either fund an account or pay their bill via our interactive voice response system. If an account has been blocked because funds are low, or a bill is due, users can unblock their account through this convenient payment method. Users can also access Securus Online to pay bills and fund accounts.

Upon payment verification, the blocked status is removed, and calls can begin processing immediately.

Account Activator

Securus completes as many calls as possible, and provides the inmate with descriptive prompts as to why a call might be blocked. One of our initiatives for completing every call is our Account Activator application.

For calls to numbers that can't be billed with traditional collect billing methods, Account Activator allows a brief conversation to occur during the first call to that number and then requires the called party to set up an account to receive future calls.

After the brief conversation, the inmate's friend or family member is connected to Securus' IVR in an attempt to set up a billing arrangement. During this time, the inmate is informed of the blocked status and requested to call at a later time while an account is set up for the called party.

Automated Operator Services

SCP includes an Interactive Voice Response (IVR) system that provides Automated Operator Services (AOS). This automated assistance uses clear and concise, professionally recorded voice prompts to establish call acceptance and to assist inmates and called parties throughout the calling process.

When the called party answers the phone, SCP's advanced answer detection triggers the call acceptance voice prompt. The called party hears, "Hello, you are receiving a collect call from [inmate's name], an inmate at the [DOCCS facility]. This call is subject to monitoring and recording." SCP then gives the called party the following menu options:

- "To accept this call, press 1."
- "To refuse this call press 2."
- "To hear the rates and charges for this call, press 7."
- "To block future calls to your number, press 6."

Additional options provided by AOS include:

Available Options to Called Parties

Request a rate quote
Hear the name of the facility and inmate calling
Accept or reject the call
Request available balance of an AdvanceConnect account or available credit of the Direct Bill account
Hear instructions on how to add more money to their prepaid account or pay their Direct Bill Account
Connect to a live agent to setup a pre-paid account
Choose to hear the prompts on the system in English, or the language selected by the

Available Options to Inmates

Listen to prerecorded announcements
Choose to place a collect or debit call; if debit, PIN entry is requested, the inmate hears the available balance in their account and the cost of the call
Select a specific language at the beginning of the call (if configured)
Acknowledge that the call is going to be monitored and recorded
Hear available call time (prompt will tell the inmate call time limits based on calling schedules or calling restrictions)

inmate (if configured for this option)
Pay for the incoming call with InstantPay (if available)
Hear optional marketing message (by request of DOCCS)
Block their number prior to accepting a call using SCP's patented Perma Block technology*

Identify themselves by PIN or Voice Biometrics (if configured)
Add, remove, and/or listen to the phone numbers on their PAN list (if configured)
Hear optional marketing message (by request of DOCCS)

***SCP's automated operator also provides a patented Perma Block process, which allows a called party to block their number permanently. This feature may be used to block calls from any inmate in the facility. The ability to immediately block calls helps reduce the number of called party complaints. The called party can also choose to end the call by hanging up. A called party can contact the call center to unblock future calls.**

Blocking / Unblocking Calls – Securus Online

Inmate friends and family members can manage all phone services, video visitation services, and email services from www.securusutech.net/friends or www.securustechnologies.com.

Securus Online

The screenshot shows the Securus Technologies website interface. At the top, there is a navigation bar with links for 'My Account', 'Phone Services', 'Video Services', 'Securus Alerts', 'My Settings', 'Customer Care', and 'Securus Home'. Below this is a promotional banner for 'Securus Video Visitation' with the text 'allows you to visit from ANYWHERE!!' and 'Download the Securus Video Visit App Today!'. The banner includes logos for Google Play and the App Store. Below the banner is a 'Phone Services' section. On the left, it displays 'ADVANCE CONNECT' and account details: 'Phone Number: (972) 922-8823', 'Account Number: 12454515', and 'Available Funds: \$0.00'. There is a green 'ADD FUNDS' button and a dropdown menu for 'Manage Account' with options: 'Call Details', 'Transaction Details', and 'Block & Unblock Calls'. A blue arrow points to the 'Block & Unblock Calls' option. Below this is a 'Manage Account' section with links for 'Authorized Phone Numbers', 'Securus Alerts', 'Account Statement', and 'AutoPay/TextPay Enrollment', each with an 'Edit' or 'Enroll' link. A 'Close Account' link is also present.

Global Call Blocking

Securus will establish a global call blocking table during installation that prevents inmates from making calls to specific numbers. Typically, the database includes numbers to local judges, sheriffs, facility personnel, jury members, attorneys and witnesses. SCP offers unlimited blocking so the call blocking table may contain as many entries as needed.

All dial-around area codes and exchanges, such as 800, 900, and 976, are blocked by default. Access to live operator services, such as 0, 411, and 911, are also blocked by default.

Authorized facility personnel can administer blocked numbers using the SCP user interface. All blocked numbers have an associated "Note" field stored in the blocked number database to record specific information for future reference.

Global Lists – Number Blocking

HOME SYSTEM MONITOR TOOLS ADMIN FACILITY PORTAL

MANAGEMENT LEVEL

Facility	Site	Phone Group	Phone
Securus Demo Site	All Sites	All Phone Groups	All Phones

General Global Lists Calling Restrictions

+ Add New

GLOBAL LIST SEARCH CRITERIA

(Use * for wild card / partial searches)

Dialled Number: 999 9999999 <small>City Code / Phone</small>	Blocked: <input checked="" type="checkbox"/>	Reason: Witness number	Private: <input type="checkbox"/>	Watch: <input type="checkbox"/>
Dialing COS: ---	Status: ACTIVE	Record Calls: <input type="checkbox"/>	Passive Acceptance: <input type="checkbox"/>	Word Spotting: <input type="checkbox"/>
Speed Dial:	Description:			

Search Reset

Call Termination Warning

The Securus call termination warning provides the inmate and the called party notifications of call termination, and to notify why a call is blocked or not completed, by voice prompt one minute before the end of the pre-programmed call time limit. All call records contain a reason for termination code indicating why each call ended. Examples of termination reasons are:

- “The person you called has hung up. Goodbye.”
- “Your call was answered but positive acceptance was not received from the called party possibly indicating an answering machine. Goodbye.”
- “The number you called is busy. Please try again later. Goodbye.”
- “The number you dialed was not answered. Goodbye.”
- “No third party calls are allowed. This call is being terminated. ”
- “Your PIN is inactive. Please hang-up and try your call again at a later time. ”
- “Thank you for using [brand name] {Securus}.”
- “No calls are allowed at this time. Goodbye.”
- “Your call was not accepted. Goodbye.
- “You have entered an invalid response, please hang up and try your call again. Goodbye.”
- “Your allowed numbers list is full. Goodbye.”
- “The number you dialed is not on your approved calling list. Goodbye.”
- “This call is being terminated by the facility. Goodbye.”
- “The prepaid account balance is lower than needed to place this call.”

- “You do not have sufficient funds to continue this call. Please hang-up and try your call again at a later time.”
- “Please hang-up and try your call again at a later time.”
- “That is not a valid mail box id. Thank you for using {product name}. [example: the Crime Tip System] .”
- “The number you dialed is blocked from receiving collect calls at this time. Goodbye.”
- “The number you dialed is blocked from receiving calls at this time.”
- “Your account has been suspended. Goodbye.”
- “That number is restricted. Goodbye.”
- “The number you dialed was not answered. Goodbye.”
- “You have entered an invalid telephone number.”
- “Your PIN is not authorized for use at this facility.”
- “That is not a valid PIN number. Your account information cannot be verified at this time. Please hang-up and try your call again at a later time.”
- “You have reached your maximum number of calls allowed.”

Instant Pay™ Program

As an option, DOCCS can implement Securus’ Instant Pay™ Program. When an inmate at your facility attempts to make a call, our validation system will attempt, through multiple means, to connect the call. If the called party does not have a prepaid or post-paid account established with Securus, or we are unable to process the call due to local phone company or other restrictions, the call will route to our Instant Pay™ platform. Called parties will be given the option to receive and pay for a single call immediately using one of our Instant Pay™ options rather than be blocked. With Instant Pay™, called parties hear a promotional messaging offering the following options:

- **Pay Now™** – Provides the called party with a 20-second promotional call every 15 to 30 days at no charge and then offers the option to Pay Now™ using a credit or debit card. The called party also has the option to be transferred to our Customer Service Center to open a prepaid, AdvanceConnect™ account.
- **Text2Connect™** – Connects a promotional call made to a mobile phone through the acceptance of a premium SMS text message. The called party’s mobile provider charges for the message their mobile phone bill. The called party receives a text message receipt for the SMS text message and is given the option to learn how to open a prepaid AdvanceConnect™ Account. Text2Connect™ is available through our third-party processor who maintains relationships with select mobile phone companies around the country and manages the connection.

The Instant Pay™ Program with Pay Now™ and Text2Connect™, from Securus, is unlike any competitive solution because it enables an inmate's critical "first call." The program also creates more prepaid accounts, completes more calls that others cannot, and allows detainees to bond out quicker and more effectively. The Instant Pay™ program's ability to connect almost any call results in increased revenue and reduced administrative burden for our facility customers.

4.2.6 Vendor Account Policies

Identify in the proposal all policies including, but not limited to, call limits, billing amount limits, collect or pre-payment caps, and call-blocking criteria they plan to apply to customer accounts. DOCCS reserves the right to accept or reject any or all proposed policies.

SECURUS HAS READ, AGREES AND WILL COMPLY WITH THIS REQUIREMENT.

Securus will work with DOCCS to establish policies for call limits and call-blocking criteria.

We offer three different methods for receiving calls:

- AdvanceConnect / Prepaid account. There is no imposed threshold set on a prepaid account.
- Direct-billed account. A credit check may be required and a credit limit is established if a customer chooses to have a direct billed account. The customer will receive either a \$300 or \$100 spending limit for a 30 day period. If the credit check results do not qualify for a direct-billed account, the customer needs to establish a prepaid account.
- Local Exchange Carrier (LEC)-billed account. Customers that are LEC-billed are subject to Securus risk management practices that specify the credit and usage limits for each billed telephone number. Our process assigns each number a 90-day PVP (payment verification point) which establishes a spending limit for that period (which can be up to \$900). If usage during that period exceeds the assigned limit, or if a high-velocity threshold (e.g. >\$60 of usage in a 24 hour period), the called party will be required to contact our Customer Service organization to avoid future call blocking. This advanced ability allows Securus to extend the maximum credit to the called party so that they do not have to set-up an account with us to receive calls. It further helps to limit fraud—keeping your constituents safe.

4.2.7 Vendor Policy Changes

The vendor must notify DOCCS and the customers (all account holders) before implementing policy changes including, but not limited to, call limits, billing amount limits, collect or pre-payment caps and call-blocking criteria. All policy changes must be pre-approved by DOCCS and the appropriate regulatory authority.

SECURUS HAS READ, AGREES AND WILL COMPLY WITH THIS REQUIREMENT.

4.2.8 Aggregated Billing Account for DOCCS-Approved Organizations

During the term of the contract, DOCCS may identify individuals or organizations that are approved to receive, at no additional charge, a single monthly bill for multiple accounts with billing detail at the individual account, groups (i.e. location specific) and master account level.

Describe how such billing will be performed, and identify any limitations associated with such aggregate billing. Include a sample bill reflecting monthly billing for individual lines, groups of lines and the master account.

SECURUS HAS READ, AGREES AND WILL COMPLY WITH THIS REQUIREMENT.

Securus has over 30 years of billing experience in the correctional marks and has focused on improving the customer's experience. Securus Omni-commerce is a strategy that delivers a seamless customer experience through all available channels. Securus multichannel approach to sales seeks to provide the customer with a seamless experience whether the customer is online from a desktop or a mobile device, by telephone.

Securus offers Family and Friends two type of billing options AdvanceConnect / Prepay and Direct Bill.

- **AdvanceConnect/Prepaid account:** There is no spending limit set on a prepay account. The customer makes the choice as to how much he or she wants to spend and how much money to put in the account. Prepayment does not require a minimum payment. To control credit card fraud the maximum funding amount per transaction is \$50.00 and can be negotiated at contract award. Additionally; customers (family and friends) can now pay for a single call without prior to establishing and account or when funds are depleted in the AdvanceConnect account.
 - Chargebacks or Credit Card reversals are deducted from the account.
 - Ongoing, the account is restricted to cash only funding. Acceptable payment processors are Western Union, Money Gram, money order or cashier's check
- **Direct-billed accounts by Securus:** Securus offers direct billing as an option to our end user customers. A direct-billed account allows collect calls to be billed monthly

directly from Securus Correctional Billing Services. To set up a direct-billed account, the inmate's family or friends member provide Securus Correctional Billing Services with their billing telephone number, name, and address, and are subject to a credit check (as allowed by state regulations). Securus does not restrict its direct billed option to businesses and attorneys.

Family and friends have 28 days from the invoice date to pay their direct bill. Accounts are past due on day 29 and Securus will block calling to the billed number until the account is paid in full. Securus does not charge a non-refundable deposit or charge for an account that has not been paid within thirty (30) days of bill due date. Securus does not charge a bill processing fee for the monthly statement.

Non-payment Direct Bill (Collect) block –removed immediately upon receipt of payment.

Direct Billed customers exceeding their monthly collect calling credit limit can reduce their balance owe, and drop below their credit limit by making a payment, at any time. When the amount owed is below the credit limit the account is immediately unblocked.

Securus will convert Direct Billed accounts, 7 days past due, to AdvanceConnect / Prepay.

- In addition, should the facility choose to implement an inmate-owned prepaid calling options, such as debit or prepaid calling cards, these calls would connect regardless of any AdvanceConnect or Direct Bill restrictions. Inmates may call individuals that do not have an AdvanceConnect or Direct Bill account improving the inmate experience and increasing the NY DOC's revenue.
- **Maximize calling opportunities for inmates and their families and friends.**

AdvanceConnect AutoPay – When a customer register to use AutoPay with their AdvanceConnect account, their credit card is automatically debited, by a user's selected preset amount, when the account balance drops below the user's preset amount. The Payor will receive a text notification with payment confirmation.

AdvanceConnect TextPay - When a customer register to use TextPay with their AdvanceConnect account, they will receive a text notification that will give them the option to fund their AdvanceConnect account immediately with a preset amount of their choice by responding with the word PAY. The Payor will receive a text notification with payment confirmation.

Text Alerts and Notifications services assist Family and Friends

- a. AdvanceConnect Low Balance Notification
- b. Direct Bill Invoice Due Notification
- c. AdvanceConnect auto Pay Payment Notification
- d. AdvanceConnect TextPay Notification
- e. Direct Bill TextPay Notification.

- **Billing Accuracy: Securus prides itself on Billing Accuracy**

- Securus subscribes to KFR Services, Local Calling Area Data, an industry standard and acknowledged telecommunications professional source. Monthly, Securus updates the local calling tables to ensure the highest level of accuracy and remain compliant with our tariff filings.
- Securus Subscribes to the Terminating Point Master (TPM) produced by iconective / Telcordia Technologies, Inc., the industry recognized source for touting and rating data. This data covers the United States and U.S. Territories, Canada, and Certain countries in the Atlantic and Caribbean.
- To ensure proper rating Securus follows a rigorous auditable change management process. No rate can take place without Vice President and Regulatory approval. Annually a third party auditor, Montgomery Coscia Greulich LLP audits Securus Compliance with all rates and compliance with tariffs.

Securus is unique among its national competitors in offering an in-sourced, US-based call center to provide customer service to friends and family members of inmates. Our 200+ seat call center employs customer service representatives who are Securus employees, trained and managed to Securus' standards.

Live agent support is available to friends and family members seven days a week, 24 hours a day, and 365 days a year.

Customers can use our toll-free number (1-800-844-6591) to either speak to a live agent or use an intuitive, automated interactive voice response system to help them with their needs. For added convenience, we also offer personal account access via our website (www.securustechnologies.com). End-users can also now access Securus customer service via online "chat" 24 hours a day, seven days a week.

Our friendly and knowledgeable agents can help customers with:

- Setting up and funding accounts
- Making payment arrangements

- Obtaining information on credit limits
- Resolving complaints
- Blocking and unblocking numbers
- Reviewing call durations and history
- Learning about MoneyGram® options
- Learning about Western Union® options
- Receiving information on new services
- Confirming originating facility
- Reviewing account balances
- Answering questions and helping customers with refund requests
- Managing account notifications

Customer Satisfaction

Our customer service agents are highly trained on ITS issues and in satisfying the specific needs of called parties. We offer both English speaking and Spanish speaking agents.

We diligently survey our customers and measure satisfaction ratings to find ways to improve our service levels. Our customer satisfaction scores for our call center are 20 percent higher than the industry standard.

Maximize Calling Opportunities

Securus is unique among its national competitors in offering an in-sourced, US-based call center to provide customer service to friends and family members of inmates. Our 200+ seat call center employs customer service representatives who are Securus employees, trained and managed to Securus' standards.

Live agent support is available to friends and family members seven days a week, 24 hours a day, and 365 days a year.

Customers can use our toll-free number (1-800-844-6591) to either speak to a live agent or use an intuitive, automated interactive voice response system to help them with their needs. For added convenience, we also offer personal account access via our website (www.securustechnologies.com). End-users can also now access Securus customer service via online "chat" 24 hours a day, seven days a week.

Our friendly and knowledgeable agents can help customers with:

- Setting up and funding accounts
- Making payment arrangements
- Obtaining information on credit limits
- Resolving complaints

- Blocking and unblocking numbers
- Reviewing call durations and history
- Learning about MoneyGram® options
- Learning about Western Union® options
- Receiving information on new services
- Confirming originating facility
- Reviewing account balances
- Answering questions and helping customers with refund requests
- Managing account notifications

Assurance of Accuracy in Billing and Customer Satisfaction

Our customer service agents are highly trained on ITS issues and in satisfying the specific needs of called parties. We offer both English speaking and Spanish speaking agents.

We diligently survey our customers and measure satisfaction ratings to find ways to improve our service levels. Our customer satisfaction scores for our call center are 20 percent higher than the industry standard.

There are no limitations at this time. Terms are Net 30.

Below is a sample bill reflecting monthly billing for individual lines, groups of lines and the master account. Securus will develop a bill for DOCCS to the example.

Securus Technologies, Inc.
 Call Commission Report - December 2013
 RUNDATE: 1/9/2013 1:33:33 PM Process Date: 1/14/2013 1:55:22 PM
 Site: Contract ID: Site ID:

LEC Billed Collect

Orig ANI	Local Revenue Mins.	Local Calls	Int'l Revenue Mins.	Int'l Calls	Interstate Revenue Mins.	Interstate Calls	Wireless Revenue Mins.	Wireless Calls	Int'l Revenue Mins.	Int'l Calls	Int'l Revenue Mins.	Int'l Calls	Int'l Revenue Mins.	Int'l Calls	Total Revenue	Total Calls	Commission	
111111111	\$1,200.00	500	\$4,402.96	1744	113	50.21	165	0	\$1,310.00	110	0	0	0	0	\$7,146.96	2404	1611	\$3,715.36
Total	\$1,200.00	500	\$4,402.96	1744	113	50.21	165	0	\$1,310.00	110	0	0	0	0	\$7,146.96	2404	1611	\$3,715.36

Parasolid Collect

Orig ANI	Local Revenue Mins.	Local Calls	Int'l Revenue Mins.	Int'l Calls	Interstate Revenue Mins.	Interstate Calls	Wireless Revenue Mins.	Wireless Calls	Int'l Revenue Mins.	Int'l Calls	Int'l Revenue Mins.	Int'l Calls	Int'l Revenue Mins.	Int'l Calls	Total Revenue	Total Calls	Commission	
111111111	\$6,000.00	32516	\$17,783.08	67156	409	3303.64	103	57	\$1,293.50	149	0	0	0	0	\$25,276.22	11600	5974	\$13,921.00
Total	\$6,000.00	32516	\$17,783.08	67156	409	3303.64	103	57	\$1,293.50	149	0	0	0	0	\$25,276.22	11600	5974	\$13,921.00

Direct Billed Collect

Orig ANI	Local Revenue Mins.	Local Calls	Int'l Revenue Mins.	Int'l Calls	Interstate Revenue Mins.	Interstate Calls	Wireless Revenue Mins.	Wireless Calls	Int'l Revenue Mins.	Int'l Calls	Int'l Revenue Mins.	Int'l Calls	Int'l Revenue Mins.	Int'l Calls	Total Revenue	Total Calls	Commission	
111111111	\$50.00	205	\$45.12	69	147	\$0.00	0	0	\$0.00	0	0	0	0	0	\$91.12	107	167	\$37.25
Total	\$50.00	205	\$45.12	69	147	\$0.00	0	0	\$0.00	0	0	0	0	0	\$91.12	107	167	\$37.25

Grand Total: \$7,940.00 38111 2004 \$23,551.16 100297 5462 \$355.86 2000 77 \$3,868.61 2654 189 \$0.00 0 0 \$30,039.65 14006 7752 \$17,175.42

OTHER REVENUE

Revenue Type	Orig ANI	Items	Revenue	Commission
Collected Pay Telephone		0	\$0.00	\$0.00
GTL Callground		0	\$0.00	\$0.00
Inter Pay - Pay Now		0	\$0.00	\$0.00
Inter Pay - TwoConnect		0	\$0.00	\$0.00
Legacy Operator Assistant		0	\$0.00	\$0.00
SM		0	\$0.00	\$0.00
Waf		0	\$0.00	\$0.00
Total:			\$0.00	\$0.00

Total Revenue: \$33,029.65
Commission Due: \$17,175.42

SECURUS Technologies, INC

1212 N. Post Oak Rd., Ste. 100
Houston, Texas 77055
Phone 832.553.9537 Fax 832.553.9530

Bill To:
Company Name
Dennis Rose
250 W Main St 5th Flr
Lexington, KY 40507

Remit To:
Securus Technologies
P.O. BOX 639098
CINCINNATI, OH 45263-9098
Tax ID: 05-0583854

CUSTOMER NUMBER	PERIOD	INVOICE DATE	INVOICE #	TERMS	AMOUNT DUE
	201612	12/31/2016		Net 30	\$78,983.89

	Number of Days	Rate	Total
BluTag Active	23,609	\$2.95	\$69,646.55
BluBand Cellular	47	\$2.00	\$94.00
Shelf Charges BluTag	5,720.50	\$1.48	\$8,466.34
Shelf Charges BluBand	777.00	\$1.00	\$777.00
			\$78,983.89

Shelf Allowance (25 %)	Total Days	Assigned Days	Shelf Days	Allowed Shelf	Billable Shelf Days
Shelf Charges BluTag	35,088	23,494	11,594	5,873.50	5,720.50
Shelf Charges BluBand	777	0	777	0.00	777.00
Shelf Charges BluHome Cellular	47	47	0	11.75	0.00

This invoice has been certified true and accurate by Dennis Rose
Make all checks payable to Satellite Tracking of People LLC
If you have any questions concerning this invoice please contact STOP customer service @ 832.553.9537

PAYMENT STUB

SECURUS Technologies, INC.™

IMPORTANT: PLEASE
DETACH AND RETURN THIS
PORTION TO ENSURE
PROPER CREDIT

Corisoft

Securus Technologies, INC
P.O. BOX 639098
CINCINNATI, OH 45263-9098

PLEASE PAY FROM THIS INVOICE.
REFER TO THIS INVOICE WHEN
CONTACTING US REGARDING THIS
TRANSACTION.

CUSTOMER	
INVOICE NUMBER:	
AMOUNT DUE:	\$78,983.89
AMOUNT REMITTED:	

1 - CORRISOFT	
	Number of Days
BluTag Active	22,834
BluBand Cellular	47
GA - Athens-Clarke County	
	Number of Days
BluTag Active	589
KY - Allen County	
	Number of Days
BluTag Active	16
KY - Grant County	
	Number of Days
BluTag Active	55
NC - Martin County	
	Number of Days
BluTag Active	115

Agency	Agent	Enrollee	Enrole Risk Level	Enrollee Primary Number	Secondary ID	Tracking Device	Tracking Device Mode	Docking Station Device	Docking Station Product	Start Date	Stop Date	Billable Days
Company Name	Device Data API	Device: 12-200193				12-200193	BluTag Active			12/20/2016	12/27/2016	8
Company Name	Device Data API	Device: 12-200193				12-200193	BluTag Active			12/01/2016	12/18/2016	18
Company Name	Device Data API	Device: 12-200275				12-200275	BluTag Active			12/01/2016	12/19/2016	19
Company Name	Device Data API	Device: 12-202011				12-202011	BluTag Active			12/01/2016	12/15/2016	15
Company Name	Device Data API	Device: 12-202049				12-202049	BluTag Active			12/01/2016	12/21/2016	21
Company Name	Device Data API	Device: 12-202049				12-202049	BluTag Active			12/22/2016	12/27/2016	6
Company Name	Device Data API	Device: 12-202872				12-202872	BluTag Active			12/01/2016	12/18/2016	18
Company Name	Device Data API	Device: 12-203849				12-203849	BluTag Active			12/01/2016	12/01/2016	1
Company Name	Device Data API	Device: 12-203849				12-203849	BluTag Active			12/06/2016	12/27/2016	22
Company Name	Device Data API	Device: 12-207423				12-207423	BluTag Active			12/01/2016	12/20/2016	20
Company Name	Device Data API	Device: 12-207423				12-207423	BluTag Active			12/23/2016	12/27/2016	6
Company Name	Device Data API	Device: 12-208518				12-208518	BluTag Active			12/01/2016	12/27/2016	27
Company Name	Device Data API	Device: 12-209037				12-209037	BluTag Active			12/01/2016	12/27/2016	27
Company Name	Device Data API	Device: 12-209510				12-209510	BluTag Active			12/01/2016	12/27/2016	27
Company Name	Device Data API	Device: 12-209885				12-209885	BluTag Active			12/01/2016	12/27/2016	27
Company Name	Device Data API	Device: 12-210386				12-210386	BluTag Active			12/01/2016	12/27/2016	27
Company Name	Device Data API	Device: 12-210752				12-210752	BluTag Active			12/01/2016	12/24/2016	24
Company Name	Device Data API	Device: 12-210952				12-210952	BluTag Active			12/01/2016	12/27/2016	27
Company Name	Device Data API	Device: 12-211994				12-211994	BluTag Active			12/01/2016	12/05/2016	5
Company Name	Device Data API	Device: 12-211994				12-211994	BluTag Active			12/07/2016	12/27/2016	21
Company Name	Device Data API	Device: 12-212148				12-212148	BluTag Active			12/01/2016	12/14/2016	14
Company Name	Device Data API	Device: 12-212419				12-212419	BluTag Active			12/01/2016	12/05/2016	5
Company Name	Device Data API	Device: 12-212524				12-212524	BluTag Active			12/01/2016	12/27/2016	27
Company Name	Device Data API	Device: 12-212821				12-212821	BluTag Active			12/27/2016	12/27/2016	1
Company Name	Device Data API	Device: 12-212821				12-212821	BluTag Active			12/01/2016	12/25/2016	25
Company Name	Device Data API	Device: 12-213294				12-213294	BluTag Active			12/01/2016	12/27/2016	27
Company Name	Device Data API	Device: 12-213426				12-213426	BluTag Active			12/01/2016	12/27/2016	27
Company Name	Device Data API	Device: 12-214033				12-214033	BluTag Active			12/01/2016	12/31/2016	31
Company Name	Device Data API	Device: 12-214679				12-214679	BluTag Active			12/01/2016	12/27/2016	27
Company Name	Device Data API	Device: 12-214899				12-214899	BluTag Active			12/01/2016	12/27/2016	27
Company Name	Device Data API	Device: 12-215419				12-215419	BluTag Active			12/01/2016	12/04/2016	4
Company Name	Device Data API	Device: 12-217565				12-217565	BluTag Active			12/01/2016	12/08/2016	8
Company Name	Device Data API	Device: 12-217565				12-217565	BluTag Active			12/09/2016	12/27/2016	19
Company Name	Device Data API	Device: 12-218324				12-218324	BluTag Active			12/01/2016	12/27/2016	27
Company Name	Device Data API	Device: 12-219025				12-219025	BluTag Active			12/01/2016	12/27/2016	27
Company Name	Device Data API	Device: 12-219401				12-219401	BluTag Active			12/01/2016	12/27/2016	27
Company Name	Device Data API	Device: 12-219779				12-219779	BluTag Active			12/01/2016	12/12/2016	12
Company Name	Device Data API	Device: 12-219779				12-219779	BluTag Active			12/14/2016	12/15/2016	2
Company Name	Device Data API	Device: 12-220902				12-220902	BluTag Active			12/01/2016	12/27/2016	27
Company Name	Device Data API	Device: 12-220987				12-220987	BluTag Active			12/01/2016	12/14/2016	14
Company Name	Device Data API	Device: 12-221076				12-221076	BluTag Active			12/01/2016	12/27/2016	27
Company Name	Device Data API	Device: 12-221334				12-221334	BluTag Active			12/06/2016	12/14/2016	9
Company Name	Device Data API	Device: 12-221356				12-221356	BluTag Active			12/18/2016	12/27/2016	10
Company Name	Device Data API	Device: 12-221356				12-221356	BluTag Active			12/01/2016	12/15/2016	15
Company Name	Device Data API	Device: 12-221376				12-221376	BluTag Active			12/01/2016	12/13/2016	13
Company Name	Device Data API	Device: 12-221376				12-221376	BluTag Active			12/16/2016	12/27/2016	12
Company Name	Device Data API	Device: 12-221413				12-221413	BluTag Active			12/23/2016	12/27/2016	6
Company Name	Device Data API	Device: 12-221413				12-221413	BluTag Active			12/03/2016	12/08/2016	6
Company Name	Device Data API	Device: 12-221413				12-221413	BluTag Active			12/11/2016	12/20/2016	10
Company Name	Device Data API	Device: 12-221434				12-221434	BluTag Active			12/01/2016	12/27/2016	27
Company Name	Device Data API	Device: 12-222088				12-222088	BluTag Active			12/01/2016	12/27/2016	27
Company Name	Device Data API	Device: 12-222669				12-222669	BluTag Active			12/01/2016	12/14/2016	14
Company Name	Device Data API	Device: 12-230575				12-230575	BluTag Active			12/01/2016	12/02/2016	2
Company Name	Device Data API	Device: 12-231041				12-231041	BluTag Active			12/08/2016	12/27/2016	20
Company Name	Device Data API	Device: 12-231041				12-231041	BluTag Active			12/01/2016	12/06/2016	6
Company Name	Device Data API	Device: 12-231687				12-231687	BluTag Active			12/11/2016	12/27/2016	17
Company Name	Device Data API	Device: 12-231687				12-231687	BluTag Active			12/01/2016	12/08/2016	8
Company Name	Device Data API	Device: 12-231976				12-231976	BluTag Active			12/01/2016	12/27/2016	27
Company Name	Device Data API	Device: 12-231982				12-231982	BluTag Active			12/01/2016	12/27/2016	27
Company Name	Device Data API	Device: 12-232157				12-232157	BluTag Active			12/01/2016	12/27/2016	27
Company Name	Device Data API	Device: 12-232303				12-232303	BluTag Active			12/01/2016	12/27/2016	27
Company Name	Device Data API	Device: 12-232577				12-232577	BluTag Active			12/01/2016	12/27/2016	27
Company Name	Device Data API	Device: 12-232757				12-232757	BluTag Active			12/01/2016	12/27/2016	27
Company Name	Device Data API	Device: 12-232820				12-232820	BluTag Active			12/01/2016	12/27/2016	27
Company Name	Device Data API	Device: 12-232880				12-232880	BluTag Active			12/03/2016	12/08/2016	6
Company Name	Device Data API	Device: 12-232880				12-232880	BluTag Active			12/18/2016	12/27/2016	10
Company Name	Device Data API	Device: 12-232940				12-232940	BluTag Active			12/01/2016	12/27/2016	27

Company Name	Device Data API	Device: 12-775101	12-775101	BluTag Active	12/01/2016	12/31/2016	31
Company Name	Device Data API	Device: 12-775104	12-775104	BluTag Active	12/01/2016	12/19/2016	19
Company Name	Device Data API	Device: 12-775165	12-775165	BluTag Active	12/01/2016	12/31/2016	31
Company Name	Device Data API	Device: 12-775509	12-775509	BluTag Active	12/01/2016	12/14/2016	14
Company Name	Device Data API	Device: 12-776646	12-776646	BluTag Active	12/01/2016	12/13/2016	13
Company Name	Device Data API	Device: 12-776647	12-776647	BluTag Active	12/10/2016	12/12/2016	3
Company Name	Device Data API	Device: 12-776647	12-776647	BluTag Active	12/05/2016	12/08/2016	3
Company Name	Device Data API	Device: 12-776650	12-776650	BluTag Active	12/01/2016	12/13/2016	13
Company Name	Device Data API	Device: 12-776674	12-776674	BluTag Active	12/01/2016	12/12/2016	12
Company Name	Device Data API	Device: 12-776790	12-776790	BluTag Active	12/01/2016	12/09/2016	9
Company Name	Device Data API	Device: 12-776811	12-776811	BluTag Active	12/01/2016	12/13/2016	13
Company Name	Device Data API	Device: 12-776930	12-776930	BluTag Active	12/01/2016	12/12/2016	12
Company Name	Device Data API	Device: 12-777071	12-777071	BluTag Active	12/01/2016	12/14/2016	14
Company Name	Device Data API	Device: 12-777139	12-777139	BluTag Active	12/01/2016	12/12/2016	12
Company Name	Device Data API	Device: 12-777272	12-777272	BluTag Active	12/01/2016	12/14/2016	14
Company Name	Device Data API	Device: 12-777412	12-777412	BluTag Active	12/03/2016	12/05/2016	3
Company Name	Device Data API	Device: 12-777412	12-777412	BluTag Active	12/07/2016	12/14/2016	8
Company Name	Device Data API	Device: 12-777512	12-777512	BluTag Active	12/06/2016	12/09/2016	3
Company Name	Device Data API	Device: 12-777512	12-777512	BluTag Active	12/13/2016	12/14/2016	2
Company Name	Device Data API	Device: 12-777518	12-777518	BluTag Active	12/01/2016	12/14/2016	14
Company Name	Device Data API	Device: 12-777601	12-777601	BluTag Active	12/07/2016	12/07/2016	1
Company Name	Device Data API	Device: 12-777601	12-777601	BluTag Active	12/10/2016	12/14/2016	5
Company Name	Device Data API	Device: 12-777601	12-777601	BluTag Active	12/06/2016	12/06/2016	1
Company Name	Device Data API	Device: 12-778041	12-778041	BluTag Active	12/15/2016	12/31/2016	17
Company Name	Device Data API	Device: 12-778051	12-778051	BluTag Active	12/15/2016	12/31/2016	17
Company Name	Device Data API	Device: 12-778158	12-778158	BluTag Active	12/16/2016	12/20/2016	5
Company Name	Device Data API	Device: 12-778233	12-778233	BluTag Active	12/15/2016	12/20/2016	6
Company Name	Device Data API	Device: 12-778235	12-778235	BluTag Active	12/15/2016	12/20/2016	6
Company Name	Device Data API	Device: 13-005478	13-005478	BluBand Cellular	12/18/2016	12/29/2016	12
Company Name	Device Data API	Device: 13-006002	13-006002	BluBand Cellular	12/11/2016	12/29/2016	19
Company Name	Device Data API	Device: 13-006312	13-006312	BluBand Cellular	12/01/2016	12/05/2016	5
Company Name	Device Data API	Device: 13-500834	13-500834	BluBand Cellular	12/01/2016	12/11/2016	11
GA - Athens-Clarke County	Device Data API	Device: 12-534768	12-534768	BluTag Active	12/01/2016	12/31/2016	31
GA - Athens-Clarke County	Device Data API	Device: 12-733307	12-733307	BluTag Active	12/01/2016	12/31/2016	31
GA - Athens-Clarke County	Device Data API	Device: 12-733344	12-733344	BluTag Active	12/01/2016	12/31/2016	31
GA - Athens-Clarke County	Device Data API	Device: 12-733358	12-733358	BluTag Active	12/01/2016	12/31/2016	31
GA - Athens-Clarke County	Device Data API	Device: 12-736083	12-736083	BluTag Active	12/01/2016	12/31/2016	31
GA - Athens-Clarke County	Device Data API	Device: 12-736254	12-736254	BluTag Active	12/01/2016	12/31/2016	31
GA - Athens-Clarke County	Device Data API	Device: 12-736286	12-736286	BluTag Active	12/01/2016	12/31/2016	31
GA - Athens-Clarke County	Device Data API	Device: 12-765819	12-765819	BluTag Active	12/01/2016	12/31/2016	31
GA - Athens-Clarke County	Device Data API	Device: 12-765900	12-765900	BluTag Active	12/01/2016	12/31/2016	31
GA - Athens-Clarke County	Device Data API	Device: 12-765916	12-765916	BluTag Active	12/01/2016	12/31/2016	31
GA - Athens-Clarke County	Device Data API	Device: 12-765936	12-765936	BluTag Active	12/01/2016	12/31/2016	31
GA - Athens-Clarke County	Device Data API	Device: 12-766093	12-766093	BluTag Active	12/01/2016	12/31/2016	31
GA - Athens-Clarke County	Device Data API	Device: 12-766106	12-766106	BluTag Active	12/01/2016	12/31/2016	31
GA - Athens-Clarke County	Device Data API	Device: 12-766129	12-766129	BluTag Active	12/01/2016	12/31/2016	31
GA - Athens-Clarke County	Device Data API	Device: 12-766285	12-766285	BluTag Active	12/01/2016	12/31/2016	31
GA - Athens-Clarke County	Device Data API	Device: 12-766303	12-766303	BluTag Active	12/01/2016	12/31/2016	31
GA - Athens-Clarke County	Device Data API	Device: 12-766311	12-766311	BluTag Active	12/01/2016	12/31/2016	31
GA - Athens-Clarke County	Device Data API	Device: 12-766317	12-766317	BluTag Active	12/01/2016	12/31/2016	31
GA - Athens-Clarke County	Device Data API	Device: 12-766342	12-766342	BluTag Active	12/01/2016	12/31/2016	31
KY - Allen County	Device Data API	Device: 12-760985	12-760985	BluTag Active	12/01/2016	12/16/2016	16
KY - Grant County	Device Data API	Device: 12-763218	12-763218	BluTag Active	12/01/2016	12/31/2016	31
KY - Grant County	Device Data API	Device: 12-766239	12-766239	BluTag Active	12/01/2016	12/12/2016	12
KY - Grant County	Device Data API	Device: 12-767995	12-767995	BluTag Active	12/01/2016	12/12/2016	12
NC - Martin County	Device Data API	Device: 12-732177	12-732177	BluTag Active	12/01/2016	12/06/2016	6
NC - Martin County	Device Data API	Device: 12-734062	12-734062	BluTag Active	12/01/2016	12/16/2016	16
NC - Martin County	Device Data API	Device: 12-736724	12-736724	BluTag Active	12/01/2016	12/31/2016	31
NC - Martin County	Device Data API	Device: 12-737631	12-737631	BluTag Active	12/01/2016	12/31/2016	31
NC - Martin County	Device Data API	Device: 12-737646	12-737646	BluTag Active	12/01/2016	12/31/2016	31

Agency	Tracking Device	Tracking	Start Date	Stop Date	Billable Days
Company Name	12-761327	BluTag	12/01/2016	12/31/2016	17
Company Name	12-761388	BluTag	12/01/2016	12/31/2016	4
Company Name	12-761530	BluTag	12/01/2016	12/31/2016	31
Company Name	12-730072	BluTag	12/01/2016	12/31/2016	31
Company Name	12-730096	BluTag	12/01/2016	12/31/2016	24
Company Name	12-730101	BluTag	12/01/2016	12/31/2016	8
Company Name	12-730113	BluTag	12/01/2016	12/31/2016	27
Company Name	12-761810	BluTag	12/01/2016	12/31/2016	12
Company Name	12-730167	BluTag	12/01/2016	12/31/2016	9
Company Name	12-730189	BluTag	12/01/2016	12/31/2016	20
Company Name	12-730229	BluTag	12/01/2016	12/31/2016	12
Company Name	12-730291	BluTag	12/01/2016	12/31/2016	31
Company Name	12-730307	BluTag	12/01/2016	12/31/2016	3
Company Name	12-762106	BluTag	12/01/2016	12/31/2016	12
Company Name	12-222211	BluTag	12/01/2016	12/31/2016	5
Company Name	12-730444	BluTag	12/01/2016	12/31/2016	27
Company Name	12-730457	BluTag	12/01/2016	12/31/2016	11
Company Name	12-730529	BluTag	12/01/2016	12/31/2016	27
Company Name	12-730539	BluTag	12/01/2016	12/31/2016	24
Company Name	12-730549	BluTag	12/01/2016	12/31/2016	27
Company Name	12-730554	BluTag	12/01/2016	12/31/2016	17
Company Name	12-762204	BluTag	12/01/2016	12/31/2016	27
Company Name	12-762440	BluTag	12/01/2016	12/31/2016	9
Company Name	12-730561	BluTag	12/01/2016	12/31/2016	12
Company Name	12-730572	BluTag	12/01/2016	12/31/2016	12
Company Name	12-730596	BluTag	12/01/2016	12/31/2016	12
Company Name	12-730665	BluTag	12/01/2016	12/31/2016	31
Company Name	12-730687	BluTag	12/01/2016	12/31/2016	10
Company Name	12-730696	BluTag	12/01/2016	12/31/2016	19
Company Name	12-730842	BluTag	12/01/2016	12/31/2016	4
Company Name	12-730859	BluTag	12/01/2016	12/31/2016	12
Company Name	12-730896	BluTag	12/01/2016	12/31/2016	5
Company Name	12-730908	BluTag	12/01/2016	12/31/2016	4
Company Name	12-730909	BluTag	12/01/2016	12/31/2016	2
Company Name	12-730922	BluTag	12/01/2016	12/31/2016	27
Company Name	12-730950	BluTag	12/01/2016	12/31/2016	31
Company Name	12-762585	BluTag	12/01/2016	12/31/2016	5
Company Name	12-762761	BluTag	12/01/2016	12/31/2016	3
Company Name	12-762771	BluTag	12/01/2016	12/31/2016	27
Company Name	12-762916	BluTag	12/01/2016	12/31/2016	11
Company Name	12-762954	BluTag	12/01/2016	12/31/2016	27
Company Name	12-762958	BluTag	12/01/2016	12/31/2016	23
Company Name	12-731055	BluTag	12/01/2016	12/31/2016	12
Company Name	12-731072	BluTag	12/01/2016	12/31/2016	27
Company Name	12-731075	BluTag	12/01/2016	12/31/2016	2
Company Name	12-731092	BluTag	12/01/2016	12/31/2016	22
Company Name	12-731153	BluTag	12/01/2016	12/31/2016	12
Company Name	12-731199	BluTag	12/01/2016	12/31/2016	21
Company Name	12-731208	BluTag	12/01/2016	12/31/2016	5
Company Name	12-731223	BluTag	12/01/2016	12/31/2016	12
Company Name	12-763176	BluTag	12/01/2016	12/31/2016	27
Company Name	12-731303	BluTag	12/01/2016	12/31/2016	27
Company Name	12-731325	BluTag	12/01/2016	12/31/2016	4
Company Name	12-731341	BluTag	12/01/2016	12/31/2016	12
Company Name	12-731345	BluTag	12/01/2016	12/31/2016	2
Company Name	12-731356	BluTag	12/01/2016	12/31/2016	24
Company Name	12-731384	BluTag	12/01/2016	12/31/2016	3
Company Name	12-731411	BluTag	12/01/2016	12/31/2016	1
Company Name	12-731437	BluTag	12/01/2016	12/31/2016	24
Company Name	12-731463	BluTag	12/01/2016	12/31/2016	27

Company Name	12-767979	BluTag	12/01/2016	12/31/2016	14
Company Name	12-734290	BluTag	12/01/2016	12/31/2016	1
Company Name	12-734291	BluTag	12/01/2016	12/31/2016	1
Company Name	12-734382	BluTag	12/01/2016	12/31/2016	31
Company Name	12-734405	BluTag	12/01/2016	12/31/2016	3
Company Name	12-734407	BluTag	12/01/2016	12/31/2016	2
Company Name	07-008008	BluBand	12/01/2016	12/31/2016	31
Company Name	07-008011	BluBand	12/01/2016	12/31/2016	31
Company Name	07-008077	BluBand	12/01/2016	12/31/2016	31
Company Name	07-008084	BluBand	12/01/2016	12/31/2016	31
Company Name	07-008090	BluBand	12/01/2016	12/31/2016	31
Company Name	07-008126	BluBand	12/01/2016	12/31/2016	31
Company Name	07-008162	BluBand	12/01/2016	12/31/2016	31
Company Name	07-008201	BluBand	12/01/2016	12/31/2016	31
Company Name	07-008206	BluBand	12/01/2016	12/31/2016	31
Company Name	07-008211	BluBand	12/01/2016	12/31/2016	31
Company Name	07-008232	BluBand	12/01/2016	12/31/2016	31
Company Name	07-008257	BluBand	12/01/2016	12/31/2016	31
Company Name	07-008260	BluBand	12/01/2016	12/31/2016	31
Company Name	07-008277	BluBand	12/01/2016	12/31/2016	31
Company Name	07-008407	BluBand	12/01/2016	12/31/2016	31
Company Name	07-008417	BluBand	12/01/2016	12/31/2016	31
Company Name	07-008419	BluBand	12/01/2016	12/31/2016	31
Company Name	07-008427	BluBand	12/01/2016	12/31/2016	31
Company Name	07-008440	BluBand	12/01/2016	12/31/2016	31
Company Name	07-008445	BluBand	12/01/2016	12/31/2016	31
Company Name	12-211994	BluTag	12/01/2016	12/31/2016	1
Company Name	12-212821	BluTag	12/01/2016	12/31/2016	1
Company Name	12-213014	BluTag	12/01/2016	12/31/2016	12
Company Name	12-214030	BluTag	12/01/2016	12/31/2016	12
Company Name	12-206712	BluTag	12/01/2016	12/31/2016	27
Company Name	12-207423	BluTag	12/01/2016	12/31/2016	1
Company Name	12-207740	BluTag	12/01/2016	12/31/2016	27
Company Name	12-214146	BluTag	12/01/2016	12/31/2016	5
Company Name	12-214802	BluTag	12/01/2016	12/31/2016	27
Company Name	12-215200	BluTag	12/01/2016	12/31/2016	27
Company Name	12-215419	BluTag	12/01/2016	12/31/2016	23
Company Name	12-215645	BluTag	12/01/2016	12/31/2016	5
Company Name	12-216377	BluTag	12/01/2016	12/31/2016	12
Company Name	12-217443	BluTag	12/01/2016	12/31/2016	27
Company Name	12-218562	BluTag	12/01/2016	12/31/2016	27
Company Name	12-219779	BluTag	12/01/2016	12/31/2016	13
Company Name	12-220794	BluTag	12/01/2016	12/31/2016	12
Company Name	12-221334	BluTag	12/01/2016	12/31/2016	5
Company Name	12-221356	BluTag	12/01/2016	12/31/2016	2
Company Name	12-221376	BluTag	12/01/2016	12/31/2016	2
Company Name	12-221413	BluTag	12/01/2016	12/31/2016	5
Company Name	12-230283	BluTag	12/01/2016	12/31/2016	27
Company Name	12-230575	BluTag	12/01/2016	12/31/2016	25
Company Name	12-231041	BluTag	12/01/2016	12/31/2016	1
Company Name	12-231687	BluTag	12/01/2016	12/31/2016	2
Company Name	12-232318	BluTag	12/01/2016	12/31/2016	27
Company Name	12-232554	BluTag	12/01/2016	12/31/2016	12
Company Name	12-232671	BluTag	12/01/2016	12/31/2016	27
Company Name	12-232880	BluTag	12/01/2016	12/31/2016	11
Company Name	12-233161	BluTag	12/01/2016	12/31/2016	27
Company Name	12-233249	BluTag	12/01/2016	12/31/2016	12
Company Name	12-233413	BluTag	12/01/2016	12/31/2016	1
Company Name	12-233602	BluTag	12/01/2016	12/31/2016	27
Company Name	12-233626	BluTag	12/01/2016	12/31/2016	27
Company Name	12-233996	BluTag	12/01/2016	12/31/2016	12

Company Name	12-778158	BluTag	12/01/2016	12/31/2016	20
Company Name	12-778233	BluTag	12/01/2016	12/31/2016	19
Company Name	12-778235	BluTag	12/01/2016	12/31/2016	19
Company Name	12-235747	BluTag	12/01/2016	12/31/2016	12
Company Name	12-760040	BluTag	12/01/2016	12/31/2016	13
Company Name	12-760105	BluTag	12/01/2016	12/31/2016	20
Company Name	12-760143	BluTag	12/01/2016	12/31/2016	9
Company Name	12-760269	BluTag	12/01/2016	12/31/2016	9
Company Name	12-760409	BluTag	12/01/2016	12/31/2016	5
Company Name	12-760422	BluTag	12/01/2016	12/31/2016	3
Company Name	12-760476	BluTag	12/01/2016	12/31/2016	2
Company Name	12-760499	BluTag	12/01/2016	12/31/2016	5
Company Name	12-760682	BluTag	12/01/2016	12/31/2016	2
Company Name	12-760752	BluTag	12/01/2016	12/31/2016	8
Company Name	07-009779	BluBand	12/01/2016	12/31/2016	31
Company Name	12-533589	BluTag	12/01/2016	12/31/2016	31
Company Name	07-009995	BluBand	12/01/2016	12/31/2016	2
Company Name	12-760869	BluTag	12/01/2016	12/31/2016	12
Company Name	12-760935	BluTag	12/01/2016	12/31/2016	9
Company Name	12-761003	BluTag	12/01/2016	12/31/2016	27
Company Name	12-200193	BluTag	12/01/2016	12/31/2016	1
Company Name	12-200275	BluTag	12/01/2016	12/31/2016	8
Company Name	12-200324	BluTag	12/01/2016	12/31/2016	27
Company Name	12-200809	BluTag	12/01/2016	12/31/2016	20
Company Name	12-200955	BluTag	12/01/2016	12/31/2016	27
Company Name	12-201219	BluTag	12/01/2016	12/31/2016	27
Company Name	12-202011	BluTag	12/01/2016	12/31/2016	12
Company Name	12-202872	BluTag	12/01/2016	12/31/2016	9
Company Name	12-203206	BluTag	12/01/2016	12/31/2016	12
Company Name	12-203849	BluTag	12/01/2016	12/31/2016	4
Company Name	12-203878	BluTag	12/01/2016	12/31/2016	27
Company Name	12-203901	BluTag	12/01/2016	12/31/2016	12
Company Name	12-430578	BluTag	12/01/2016	12/31/2016	27
Company Name	12-431120	BluTag	12/01/2016	12/31/2016	27
Company Name	12-431300	BluTag	12/01/2016	12/31/2016	31
Company Name	12-534231	BluTag	12/01/2016	12/31/2016	31
Company Name	12-534498	BluTag	12/01/2016	12/31/2016	31
Company Name	12-500788	BluTag	12/01/2016	12/31/2016	31
Company Name	12-734462	BluTag	12/01/2016	12/31/2016	27
Company Name	12-734514	BluTag	12/01/2016	12/31/2016	27
Company Name	12-734554	BluTag	12/01/2016	12/31/2016	26
Company Name	12-734568	BluTag	12/01/2016	12/31/2016	12
2 - CORRISOFT (Monitored)	07-009466	BluBand	12/01/2016	12/31/2016	31
2 - CORRISOFT (Monitored)	07-009595	BluBand	12/01/2016	12/31/2016	31
2 - CORRISOFT (Monitored)	07-009809	BluBand	12/01/2016	12/31/2016	31
2 - min - Corisoft	12-431683	BluTag	12/01/2016	12/31/2016	9
GA - Athens-Clarke County	12-501398	BluTag	12/01/2016	12/31/2016	31
GA - Athens-Clarke County	12-761042	BluTag	12/01/2016	12/31/2016	31
GA - Athens-Clarke County	12-765220	BluTag	12/01/2016	12/31/2016	31
KY - Floyd County	12-734553	BluTag	12/01/2016	12/31/2016	31
KY - Shelby County	12-533726	BluTag	12/01/2016	12/31/2016	2
KY - Shelby County	12-533033	BluTag	12/01/2016	12/31/2016	2
NE - CEDARS	12-500183	BluTag	12/01/2016	12/31/2016	31
NE - CEDARS	12-734587	BluTag	12/01/2016	12/31/2016	31
XX - Demo - Client	12-531061	BluTag	12/01/2016	12/31/2016	31
XX - Demo - Client	12-532245	BluTag	12/01/2016	12/31/2016	31
COR - Company Name	12-530556	BluTag	12/01/2016	12/31/2016	31
COR - Company Name	12-733777	BluTag	12/01/2016	12/31/2016	31
COR - XX - Demo - ASA	12-401945	BluTag	12/01/2016	12/31/2016	31
COR - XX - Demo - ASA	07-009245	BluBand	12/01/2016	12/31/2016	31
COR - XX - Demo - ASA	12-204496	BluTag	12/01/2016	12/31/2016	31

END OF SECTION 4: CUSTOMER SERVICE

5 Performance Standards

5.1 Service Objectives

The vendor must provide services that meet the performance levels delineated below.

Describe what steps will be taken to meet or exceed DOCCS' performance and service-level objectives for the Inmate Telephone System:

SECURUS HAS READ, AGREES AND WILL COMPLY WITH THIS REQUIREMENT.

Securus provides highly reliable service from initial system design and installation through ongoing maintenance and support. Our service and maintenance program includes integrated remote programming, diagnostics, downloading, and troubleshooting capabilities. Securus does not charge for maintenance, support, training, and repair of system software and equipment.

The local Securus service and account management team provide support 24 hours per day, seven days per week, and 365 days per year (24x7x365). The local team of Securus employees has demonstrated their dedication to the counties in the state of New York.

The Securus organizational structure has proven to deliver excellent service and technological innovation. Accountability, standards of excellence and leadership begin at the top of the organization with the Securus executive leadership team and filters down to each associate in the company. Each team member has a personal commitment to delivering outstanding customer care, service excellence and the creation of powerful applications and tools to meet our customers' needs. Our goal is to form long-term partnerships with our customers. We develop new applications to help customers run their business through a deep understanding of their needs.

Network Operation Center

The Securus employees continuously monitor our Secure Calling Platform (SCP) from our Network Operations Center (NOC) at our headquarters in Dallas, Texas. The NOC is staffed 24x7x365 by network experts certified in the systems and software used to monitor all SCP functions and equipment, as well as the associated network. The NOC maintains failure reports, service history, and other diagnostic information, which are available to the County when requested.

The SCP platform provides continuous online supervision and diagnostics — as well as offline system access — for advanced programming, diagnostics, troubleshooting, and call traffic analysis. The Securus service center personnel can access the SCP advanced diagnostics and program control for failure reports, service history, and other diagnostic information.

The NOC reports any actions required to prevent or repair any outages to each Securus employee supporting DOCCS. Securus will follow DOCCS protocols for communicating outages or repair actions in the unlikely event they occur.

Securus Network Operations Center in Dallas, TX



Premium Network Monitoring Capabilities

Securus proactively identifies potential system and network abnormalities through SolarWinds® suite of network performance monitors. This software allows Securus personnel to monitor all hardware, software and system metrics continuously.

Through network monitoring Securus can:

- **Proactively repair systems to prevent outages.** Many times corrections are made before a facility is aware of a problem. This means less downtime and increased system reliability for the facility.
- **Alert remote or on-site engineers of system threshold inconsistencies or alarms.** The NOC communicates with engineers through e-mail, short message service (SMS), or directly through a wireless phone to address the issue.
- **Receive real-time alerts when the system detects an error.** Monitoring identifies if network elements exceeded established thresholds and alerts Securus personnel of possible carrier network issues.

- **Ensure sufficient resources are in place.** The Securus capacity engineering team reviews call traffic volume reports and storage requirements throughout all systems to ensure sufficient network capacity.
- **Centrally monitor calling traffic to determine increases or decreases in the number of telephones.** With DOCCS agreement, the service and operations team will install additional telephones when required.

Remote Programming, Diagnostics, and Troubleshooting

The Securus NOC uses monitors the SCP platform and our network. The NOC can contact the Technical Support Center (TSC) if it determines that another level of technical support is needed to address an issue. This action could involve dispatching a Field Services Technician to a DOCCS facility.

Technical Support Center

In 2009, Securus made a strategic decision to centralize management of all technical support. Today, Securus provides superior customer service capabilities from a state-of-the-art technical support center located in Dallas, Texas.

Approximately 50 technical professionals staff the Securus Technical Support Center (TSC) which handles approximately 8,000 inbound queries per month. The TSC provides a single-point-of-contact for Securus customers for issues ranging from minor maintenance issues to service outages. Clients can contact the TSC 24x7x365 by any of the following convenient methods:

- **Telephone** – 866-558-2323
- **E-Mail** – technicalsupport@securustech.net
- **Fax** – 800-368-3168
- **Web portal** - <http://www.securustech.net/facility/Default.asp>

The technical service center offers our clients:

- Technical support and field dispatch 24x7x365
- Fully trained staff of support professionals to answer calls
- Trained professionals to provide quick problem resolution and a higher level of customer service
- Service event tracking to drive resolutions
- Prioritized calls and analyzed reports to ensure achievement of Service Level Agreements
- Certified technicians to provide quick problem resolution
- System and individual site connectivity monitored 24x7x365

24x7x365 Securus Technical Support Center



Securus technicians receive internal Securus certifications, based on our business and the products and services we support.

Service Levels

When a facility calls Securus, an event tracking system assigns a trouble ticket, with one of three initial priority levels—P1, P2, or P3. Each level is designed to address specific system events and has a prescribed resolution timeline and escalation procedure. In all cases, Technical Support will respond to the customer within the required timeframe.

Priority 1 Service Level (DOCCS Levels 1 & 2)

A Priority 1 (P1) assignment—our highest priority assignment—occurs when a system event adversely affects 30 percent or more of system functionality. Examples of P1 service assignments include:

- Voice prompts not operating
- Features are not operating appropriately
- CD-burning abilities disabled
- Live call monitoring is not operating appropriately
- SCP access denied

- All phones out-of-service

The response time for a P1 event is two hours. If a dispatch is not required, Securus notifies the facility upon issue resolution. If a dispatch is required, Securus contacts the facility and provides an estimated time of arrival.

A P1 event escalates to:

- Technical Support Department
- Technical Support Manager
- Technical Support Director
- Regional Field Manager
- Executive Director of Service

If the problem resolution is delayed, escalation procedures within the Securus Management Team are activated to ensure appropriate resources are allocated to resolve the problem.

Priority 2 Service Level (DOCCS Levels 3 & 4)

A Priority 2 (P2) assignment—our mid-level priority assignment—occurs when a system event adversely affects 5 to 29 percent of system functionality. Examples of a P2 service assignment include problems or errors with related to:

- Workstation
- Specific system ports
- Local Exchange Carrier (LEC) circuits
- Unblocks
- Blocked numbers
- Missing call detail records (CDRs)
- Call searching

The response time for a P2 event is 24 hours. If a dispatch is not required, Securus notifies the facility upon issue resolution. If a dispatch is required, Securus contacts the facility and provides an estimated time of arrival.

P2 events escalate to the Technical Support Department.

Priority 3 Service Level (DOCCS Level 5)

A Priority 3 (P3) assignment—our lowest priority assignment—occurs when a system event adversely affects 5 percent or less of system functionality. System events adversely affecting some of available facility phones. Examples of P3 service assignments include:

- Static on the phone

- A party's inability to hear
- An inmate's inability to dial
- A broken phone
- Non-functioning dial pad
- Non-functioning cutoff switches
- An inability to generate reports

The response time for a P3 event is 72 hours. If a dispatch is not required, Securus notifies the facility upon issue resolution. If a dispatch is required, Securus contacts the facility and provides an estimated time of arrival.

P3 events escalate to the Technical Support Department.

Escalations

If a dispatch is not required, Securus notifies the facility upon issue resolution. If a dispatch is required, Securus contacts the facility and provides an estimated time of arrival.

The supervisory escalation chain is:

- Technical Support Department
- Technical Support Manager
- Technical Support Director
- Regional Field Manager
- VP Service and Technical Operations

Centralized Services Operations Model

All Securus services and operations are managed centrally, from our Service and Operations organization in Dallas, Texas. The Operations team's responsibility is supporting external customers, including Customer Service, Field Services, Installation and Engineering, and Technical Support. The Support Services team provides internal support services including Quality, Training and Customer Satisfaction, and Reporting and Analysis.

Call Routing

The TSC manages the flow of inbound calls through a call distribution system that routes calls directly to our support technicians in a skills-based, platform specific manner. Securus establishes response times and service level agreements that accomplish our key objective of providing timely resolution to each request. Service calls are answered 24x7x365 by live technicians to provide timely and quality customer service.

Trouble Ticketing Process

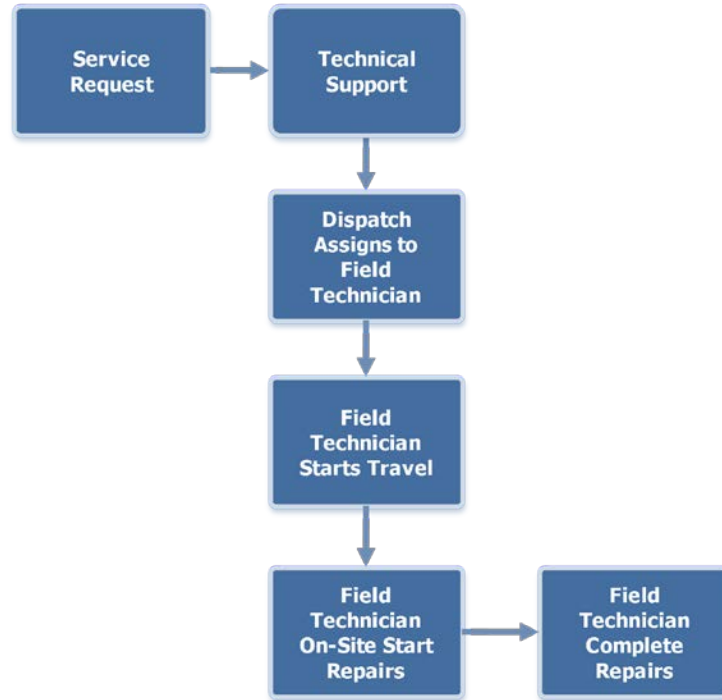

In all instances, service will be requested through the TSC and field service personnel will be dispatched through trouble ticketing system to ensure documentation and timely resolution of all service tickets.

Event Tracking System

The Securus event tracking system logs, tracks, manages, and assures an appropriate response to all service requests. The service request generates a unique trouble ticket number linked to each facility's service history and provides real-time updates. Each ticket has a priority level assignment, which drives diagnosis and response processes. The support technician performs initial problem diagnosis and isolation procedures, determines the nature of the problem, and resolves the problem or engages the appropriate party for problem resolution.

The TSC maintains ownership of all service requests and responsibility for the escalation and update functions. Every effort is made to resolve problems remotely and within the framework of resolution timeframes. However, if the problem requires on-site service, a technician is dispatched. Securus will contact the facility to arrange for the on-site service at the convenience of the facility.

County facilities can also open and track trouble tickets through our convenient facility portal.

Facility Portal

Securus provides customer facilities with one of the only anywhere, anytime, single-point-of-access customer portals in the industry. Approved users can access all calling activity, including all call detail reports. The Facility Portal also serves as the user interface to the Securus electronic trouble ticket system. Authorized users can initiate trouble tickets for repairs, track the real-time ticket status, and generate current and historical reports of trouble tickets with the Facility Portal. The facility Portal generates a tracking number for each ticket opened. Users can search for service tickets by ticket number or by date search. All updates are sent electronically in real-time to the originator of the ticket, as well as to the County designee.

Open Service Ticket

[FRIENDS & FAMILY](#) [CORRECTIONAL FACILITIES](#) [ABOUT US](#) [CAREERS](#) [CONTACT US](#)

Facility Portal

Facility Name

- Dashboard
- Portal Manager
- Commissions Reports
- General Reports
- Order Materials
- Downloads & User Guide
- Service Center
 - Your Tickets
 - Create A Ticket
 - Date Search

Create Service Ticket

Site:

Problem Category:

Suggested Priority:

Problem Description:

- Inmate Can't Place Call
- Other
- Partial Outage
- Password Reset
- Phone/Equipment Replacement
- PIN Reset
- SCP User Interface Question

Manage Your Service Tickets

FRIENDS & FAMILY CORRECTIONAL FACILITIES ABOUT US CAREERS CONTACT US

Facility Portal

Facility Name

- Dashboard
- Portal Manager
- Commissions Reports
- General Reports
- Order Materials
- Downloads & User Guide
- Service Center
 - Your Tickets
 - Create A Ticket
 - Date Search
 -
 -
- Help
 - Secure Call Platform
 - Log-Out

Your Service Tickets

SITE NAME	TICKET #	DESCRIPTION	LAST UPDATED	STATUS
Facility Name	13802698	Div 11 VB enrollments	2011-08-16 09:56:04	Closed
Facility Name	13799269	Voice Biometrics - the customer is enrolling/re-enrolling inmates in VB at Division 11...	2011-08-12 11:06:18	Closed
Facility Name	13792501	Report Request: Calls completed in 2008 from Division 1, Tier D-4 Call period is 9/1...	2011-08-05 15:19:43	Closed
Facility Name	13783054	customer reports that he creates an iso image to burn to DVD and when image was downlo...	2011-07-29 10:24:54	Closed
Facility Name	13782536	Voice Biometric - Re-enrollments the customer is doing re-enrollments of inmates at t...	2011-07-28 11:10:58	Closed

1 2 3 4 Total Tickets

Clicking the ticket number in the service history generates a report with ticket detail. Users can review all the notes and the final resolution of any closed ticket at any time. If the ticket is currently open, users can create a new journal note. Consent to close a ticket can also be performed using the notes section.

Example of ticket detail:

Ticket Detail

The screenshot shows the Facility Portal interface. At the top, there is a navigation bar with links for 'FRIENDS & FAMILY', 'CORRECTIONAL FACILITIES', 'ABOUT US', 'CAREERS', and 'CONTACT US'. Below this is the 'Facility Portal' logo. On the left side, there is a 'Marketing' sidebar with a list of links: Dashboard, Portal Manager, Reports, Order Materials, Downloads & User Guide, Service Center, Your Tickets, Create A Ticket, Date Search, Search Tickets, B-Gate, and Log-Out. The main content area is titled 'Ticket Details #13529104'. It contains a 'TICKET #13529104' section with the following information: Call Description: female pod #1 block phone not working, Ticket Priority: 3, Ticket Status: Closed, Date Opened: 12/20/2010 8:14:24 AM, Last Update: 12/20/2010 8:51:24 AM, and Solution Description: reset tips. Below this is a 'JOURNAL NOTE ENTRIES' section with two entries: 'Igreathouse 12/20/2010 8:40:03 AM Issue Resolved - waiting for Customer Approval' and 'Igreathouse 12/20/2010 8:39:53 AM Authorization Obtained from: Hogan'. At the bottom of the journal notes section is a button labeled 'Create A New Journal Note'.

Facility Portal Reports

County users can view or download several reports from the Facility Portal:

- **Calling Activity Report** – This report provides details on the number and type of calls made from a telephone number at the facility.
- **Call Type Summary Report** – This report provides details on the number and type of calls made from a specific telephone number at the facility. Calls will be broken down by local, intraLATA, interLATA and interstate.
- **Daily Call Volume Snapshot** – This report shows a daily snapshot of calls and minutes compared to the daily average
- **Monthly Call Frequency Chart** – This chart details the most frequently called numbers from the facility.
- **Preliminary Monthly Revenue Report** – This report details all calls, minutes and revenue for a specific date range.
- **Preliminary Daily Revenue** – This report details all calls, minutes, and revenue for a specific date.
- **Investigation Tool** – This tool allows for tracking of a specific dialed number from any of the approximately 2,600 facilities serviced by Securus.

The Securus Field Services Team

The Securus Field Services organization is one of the largest in the inmate phone system industry. Our team consists of approximately 150 Field Service Technicians (FSTs) located throughout the United States, including a team to support the systems in New York. Our teams have expanded based on our growing customer needs.

Our field services team installs and maintains inmate phone systems for approximately 2,600 facilities and a million inmates in 47 states. The Securus Field Operations Director manages three Regional Service Managers who possess more than 60 years of combined field service experience.

Field Service Technicians

Securus requires that all FSTs have an extensive telecommunications background and tests each applicant before employment. Additionally, FSTs receive extensive Securus training and certifications to support our product offerings.

FSTs respond to critical issues within four hours (or less if required by specific County requirements). The technician is required to follow a structured technical and management escalation process if they are unable to isolate the problem within four hours. Our integrated support model keeps our centralized technical support team engaged through problem resolution. FSTs and the technical support team have direct access to product and development engineers, enabling them to expedite repairs and minimize customer downtime.

Securus field service technicians maintain a working level of spare parts for minor repairs consisting of telephone sets, handsets, dials, and replacement circuit boards, either on-site or in their truck. If a technician does not have a required part, Securus will drop-ship the item to the site. Securus will ship counter-to-counter on the same day in critical situations.

Field Service Manager

In addition to FSTs, Securus customers are supported by field service managers who:

- Conduct remote visits via phone bimonthly. Based on information obtained from call, a trouble ticket may be opened
- Work with the account team quarterly to evaluate contract progress with the County
- Provide the facility with applicable site information that assists them based on the account profile
- Monitor ticket traffic
- Resolve escalation issues, as needed.

Each field service manager possesses the skills required to perform the duties of the field service technician and can provide additional or backup support as needed.

Service Parts

Securus field service technicians maintain a working level of spare parts for minor repairs consisting of telephone sets, handsets, dials, and replacement circuit boards, either on-site or in their truck. If a technician does not have required a part, Securus will drop-ship the item to the site. Securus will ship counter-to-counter on the same day in critical situations.

Quality

Securus sends an e-mail customer satisfaction survey to the primary site contact following each service event. Customer concerns are immediately escalated to the Regional Service Manager and the National Service Director. The Regional Service Manager is required to contact the customer within 24 hours to better understand the concern and implement a correct action plan. Securus executives review the summary of each issue along with the corrective actions on a monthly basis. Our current survey results show 94% satisfaction with Field Service with 77% indicating they were “delighted” with the service they received.

Implementation

Our preliminary implementation plan includes transitional meetings that detail the setup of proposed applications and tasks associated with the transition from the current system to Securus’ Secure Call Platform (SCP). Securus has extensive experience preparing locations for system implementation without disrupting the facility’s existing service. All hardware, phone lines, and workstations will be in place before replacing the telephone instruments and cutting over to SCP.



5.1.1 Facility Service Objectives

A. Equipment

1. Installation: Time from vendor receipt of order to working installed equipment.

Performance Standard: 20 calendar days

2. Maintenance: Monthly Meantime to Repair

Performance Standard: 8 hours

SECURUS HAS READ, AGREES AND WILL COMPLY WITH THIS REQUIREMENT.

Securus field service technicians maintain a working level of spare parts for minor repairs consisting of telephone sets, handsets, dials, and replacement circuit boards, either on-site or in their truck. If a technician does not have a required part, Securus will drop-ship the item to the site. Securus will ship counter-to-counter on the same day in critical situations.

For equipment replacement orders we strive to meet the same performance standards as our MTTR SLAs in the table below.

- **Meantime To Repair SLA's:** (Based on severity of issue - from first contact till resolved)

Priority	SVV/ConnectUs Related Issues	All Other Types	Description
1	4 Hours	2 Hours	30% or more system functionality adversely affected
2	12 Hours	24 Hours	5%-29% system functionality adversely affected
3	24 Hours	72 Hours	Less than 5% system functionality adversely affected
4	36 Hours	72 Hours	All other system issues

B. System Software

1. Updates/new releases: Time from availability to system-wide deployment

Performance Standard: 6 months

SECURUS HAS READ, AGREES AND WILL COMPLY WITH THIS REQUIREMENT.

When designed our centralized platform, one of our chief objectives was deploying a system that provided upgrades to all customers at regular intervals with no downtime. We achieved that objective with SCP. Securus provides upgrades to all of our customers three to four times annually through a proven and tested after hours process that allows all sites to immediately realize the benefits each upgrade. Our system delivers proven features driven by input from the most recognized corrections and law enforcement agencies in the nation.

Securus performs three to four software upgrades and releases each year, which easily falls under the prescribed Performance Standard.

C. Network

2. Service: Monthly Availability (entire system)

Performance Standard: 99.99% (7x24x365)

SECURUS HAS READ, AGREES AND WILL COMPLY WITH THIS REQUIREMENT.

The Securus Secure Call Platform (SCP) has been available since February 2006 and has never experienced a total system failure lasting more than 24 hours. SCP is currently installed and operated at more than 2,200 customer sites. Our Network Operations Center (NOC) is dedicated to monitoring and measuring the performance of SCP. When outages occur, our NOC staff handles them quickly to limit customer impact.

The following statistics show the most recent SCP uptime through July 31, 2016:

2012 Performance:

- SCP User Interface Availability 99.929% uptime
- SCP Platform Availability 99.983% uptime
- SCP Network Availability 100% uptime

2013 Performance:

- SCP User Interface Availability 99.986% uptime
- SCP Platform Availability 100.00% uptime
- SCP Network Availability 99.994% uptime

2014 Performance:

- SCP User Interface Availability 100.00% uptime
- SCP Platform Availability 100.00% uptime
- SCP Network Availability 100.00% uptime

2015 Performance:

- SCP User Interface Availability 99.828% uptime
- SCP Platform Availability 99.865% uptime
- SCP Network Availability 99.885% uptime

2016 Performance (as of July 31, 2016):

- SCP User Interface Availability 99.992% uptime
- SCP Platform Availability 100.00% uptime
- SCP Network Availability 100.00% uptime

5.1.2 Customer Service Objectives

A. DOCCS as customer

1. Service

a. Resolution Rates

Performance Standard: >70% of calls resolved on first call

b. Wait times

Performance Standard: Monthly mean wait time < 60 seconds

c. Access to technical support

Performance Standard: Within 10 minutes 100% of the time

2. System Availability per site: Monthly Availability within operational hours.

Performance Standard: 99.9%

3. Data Transfer and availability

a. Timing

Performance Standard: Occurs within scheduled window 98% of the time

b. Accuracy

Performance Standard: 98% of transfers complete and correct on first transfer; 100% on second transfer.

4. Inmate Calls

a. Drops and Disconnects

Performance Standard: Less than 2% per site per month

b. Voice Quality

Performance Standard: Meet quality standard 99% per month

c. Complaints

Performance Standard: Less than 5% of average annual population per month

SECURUS HAS READ, AGREES AND WILL COMPLY WITH THIS REQUIREMENT.

Customer Service	Goal	Jan-16	Feb-16	Mar-16	Apr-16	May-16	Jun-16	Jul-16	Aug-16	Sep-16	Oct-16	Nov-16	Dec-16	2016 YTD
FCR (Resolution Rate)	> 70%	80%	87%	87%	87%	88%	88%	85%	85%	85%	86%	86%	86%	87%
ASA (Wait times)	< 60 secs	14	14	11	13	14	13	8	8	7	11	9	9	11
Abd % (Abandoned calls)	3%	2%	2%	1%	2%	2%	2%	1%	0.6%	0.6%	1%	0.8%	0.8%	1%
% of Complaints	5%	0.0022%	0.0020%	0.0024%	0.0024%	0.0015%	0.0032%	0.0014%	0.0024%	0.0017%	0.0012%	0.0012%	0.0008%	0.0019%
Count of Complaints		43	39	47	47	30	63	28	47	33	23	24	16	

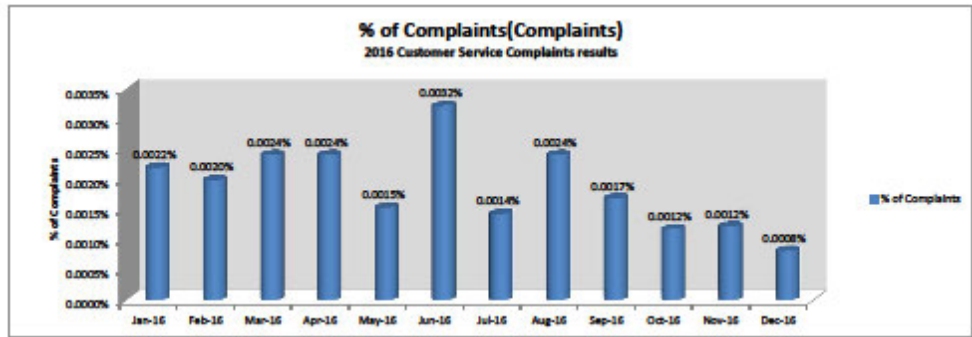
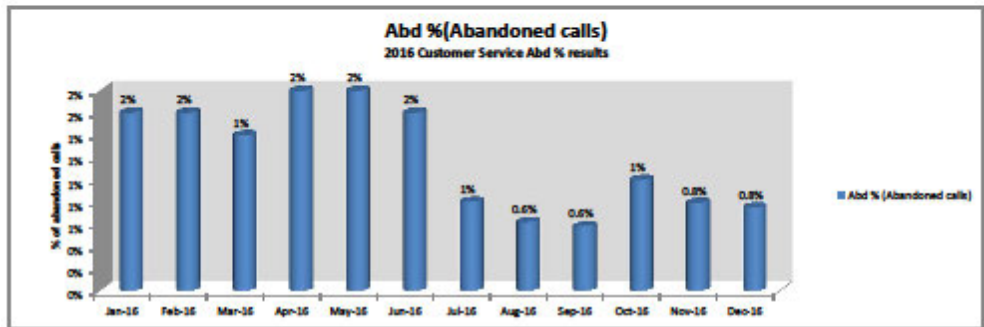
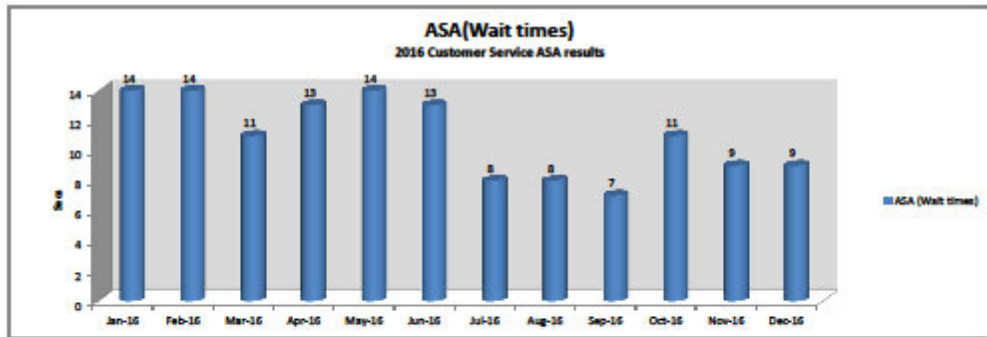
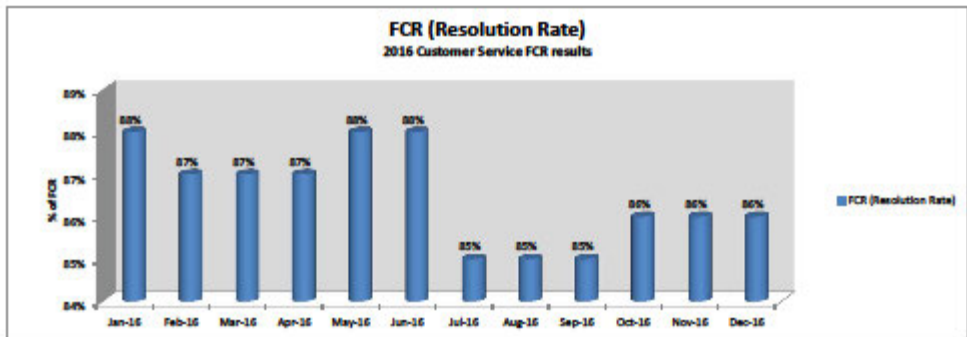

Technical Support	Goal	Jan-16	Feb-16	Mar-16	Apr-16	May-16	Jun-16	Jul-16	Aug-16	Sep-16	Oct-16	Nov-16	Dec-16	2016 YTD
ASA (Wait times)	< 60 secs	64	79	67	91	56	48	53	43	47	54	53	49	59
FCR (Resolution Rate)	> 70%	78%	75%	76%	76%	76%	78%	81%	80%	80%	78%	76%	75%	77%

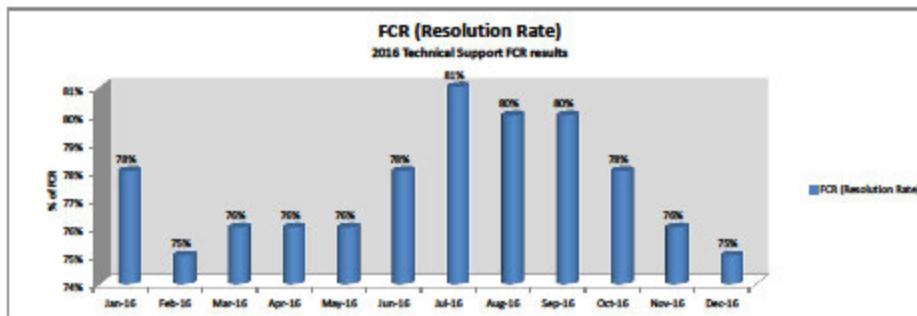
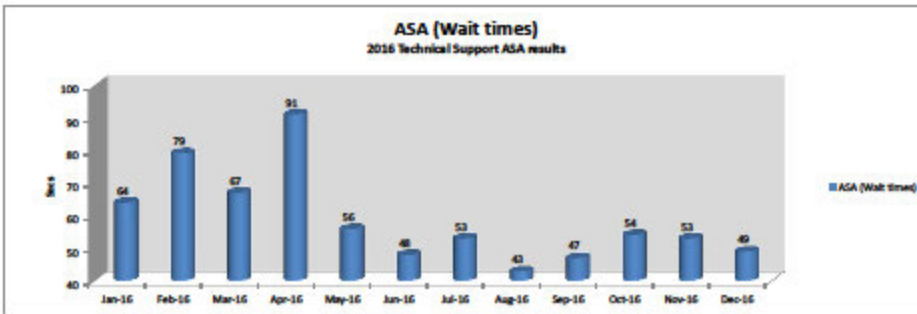

B. Inmates, family & friends as customers

1. Service

a. Resolution rate

Performance Standard: >70% of calls resolved on first call

b. Wait times

Performance Standard: Monthly mean wait time <60 seconds

c. Abandoned calls

Performance Standard: Not to exceed 10% of calls per month

d. Complaints

Performance Standard: Not to exceed 5% of accounts per year

SECURUS HAS READ, AGREES AND WILL COMPLY WITH THIS REQUIREMENT.

Customer Service	Goal	Jan-16	Feb-16	Mar-16	Apr-16	May-16	Jun-16	Jul-16	Aug-16	Sep-16	Oct-16	Nov-16	Dec-16	2016 YTD
FCR (Resolution Rate)	> 70%	88%	87%	87%	87%	88%	88%	85%	85%	85%	86%	86%	86%	87%
ASA (Wait times)	< 60 secs	14	14	11	13	14	13	8	8	7	11	9	9	11
Abd % (Abandoned calls)	30%	2%	2%	1%	2%	2%	2%	1%	0.6%	0.6%	1%	0.8%	0.8%	1%
% of Complaints	5%	0.0022%	0.0020%	0.0024%	0.0024%	0.0015%	0.0032%	0.0014%	0.0024%	0.0017%	0.0012%	0.0012%	0.0008%	0.0019%
Count of Complaints		43	39	47	47	30	63	28	47	33	23	24	16	

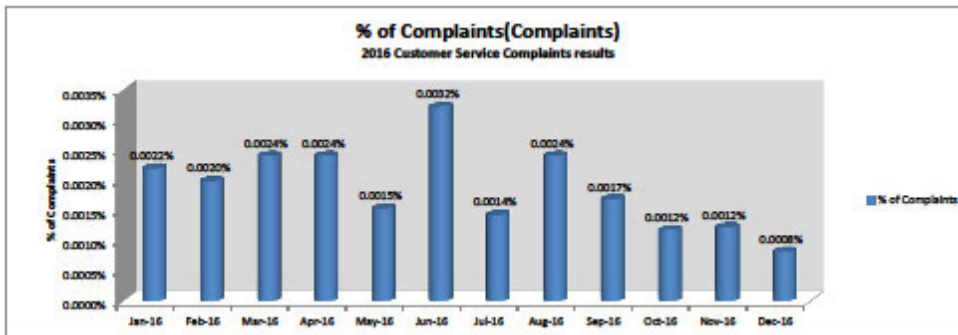
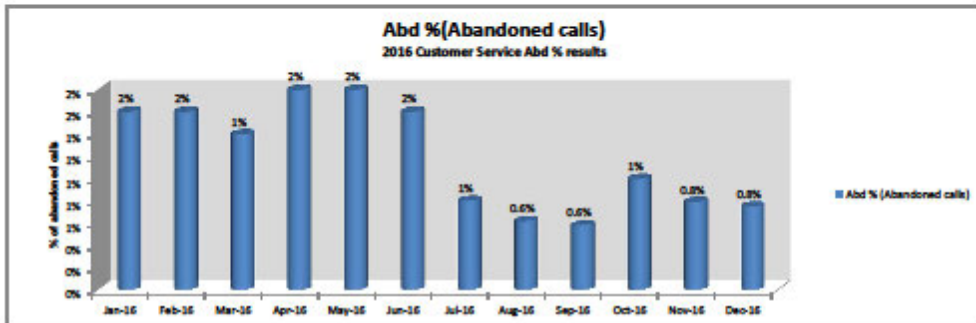
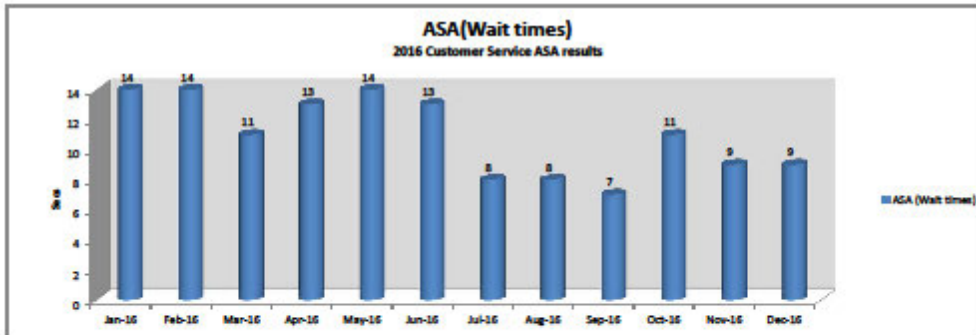
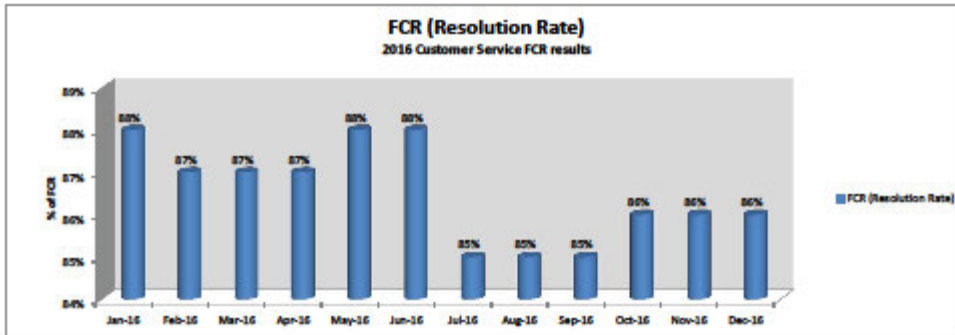

5.2

Resolution of Reported Problems

DOCCS has established priority levels 1-5 for problem reporting. Level 1 problems shall be the highest priority and level 5 the lowest. DOCCS has the sole authority to determine the priority level of each reported problem and to determine if the problem has been resolved and the issue closed. Resolution time is based on a 24-hour-per-day basis, 365-days-per-year service.

Describe what steps will be taken to meet or exceed DOCCS' problem resolution objectives.

SECURUS HAS READ, AGREES AND WILL COMPLY WITH THIS REQUIREMENT.

Securus provides superior customer service from a state-of-the-art operations center located in Carrollton, Texas. More than 50 technicians staff the Securus Technical Support Center (TSC) to ensure prompt problem resolution. The average tenure of our support management is five years and our technicians average four years.

The Securus TSC serves as a single point of contact for facility staff to request service **24 hours a day, seven days a week, 365 days per year**. There are four ways to contact the TSC:

- Telephone: 866-558-2323
- E-Mail: technicalsupport@securustech.net
- Fax: 800-368-3168
- Web portal @ <http://www.securustech.net/facility.asp>

The TSC uses a call distribution system to manage the flow of inbound customer calls automatically routing calls directly to our support technicians in a skills-based, platform specific manner. Securus establishes response times and service level agreements that accomplish our objective of providing timely resolution to each request.

Technicians assign each service request one of three initial priority levels, each with resolution and escalation timelines. Every effort is made to resolve the problem remotely within the designated timeframes, and Securus resolves most service requests during the initial request. If necessary, a field service technician is dispatched to the facility to expedite resolution.

The TSC uses an event tracking system that logs, tracks, manages and assures appropriate response to all service requests. The service request generates a trouble ticket with priority level assignment that drives diagnosis and response processes. The support technician performs initial problem diagnosis and isolation procedures, determines the nature of the problem and either resolves the problem or engages an appropriate party for problem resolution. The TSC retains ownership of all service requests and is responsible for the escalation and update functions.

Service Response Times and Escalations

Priority Level	Service Priority Description	Response Time	Customer Communication Guideline	Escalations
P1 (DOCCS Levels 1 & 2)	A P1 is our highest service level defined as 30% or more of the functionality of the System being adversely affected by the System Event. Examples of P1 service assignments would include items such as no voice prompts, features not operating appropriately, inability to burn CD's, issues with listening to live calls, inability to access S-Gate, all phones down.	2 hours	Securus Technical Support Center notifies the facility when the service issue is resolved If a technician is required, Securus Dispatch or Field Service Technician contacts the customer with an estimated time of arrival	If response is delayed, escalation procedures within Securus' Management Team are activated to ensure appropriate resources are allocated to resolve the service request Technical Support Manager & Field Service Manager Technical Support Director & Field Service Director VP Service & Operations
P2 (DOCCS Levels 3 & 4)	A P2 assignment defined as 5% to 29% of the functionality of the System being adversely affected by the System Event. Examples of a P2 service assignments would include items such as workstation, specific system ports, LEC circuits, unblocks, block numbers, missing CDRs, call searching.	24 hours	Securus Technical Support Center notifies the facility when the service issue is resolved If a technician is required, Securus Dispatch or Field Service Technician contacts the customer with an estimated time of arrival	If response is delayed, escalation procedures within Securus' Management Team are activated to ensure appropriate resources are allocated to resolve the service request Technical Support Manager & Field Service Manager Technical Support Director & Field Service Director VP Service & Operations
P3 (DOCCS Level 5)	A P3 assignment defined as less the 5% of the functionality of the System	72 hours	Securus Technical Support	If response is delayed, escalation procedures within

	<p>being adversely affected by the System Event. Single and multiple phones related issues. Examples of P3 service assignments would include items such as static on the phone, a party not being able to hear, unable to dial, a broken phone, dial pad not working, cutoff switches not working, and inability to generate reports.</p>		<p>Center notifies the facility when the service issue is resolved If a technician is required, Securus Dispatch or Field Service Technician contacts the customer with an estimated time of arrival</p>	<p>Securus' Management Team are activated to ensure appropriate resources are allocated to resolve the service request Technical Support Manager & Field Service Manager Technical Support Director & Field Service Director VP Service & Operations</p>
--	---	--	--	--

Overview

Securus employs approximately 170 field service associates including 9 Regional Managers and a centralized Field Dispatch team to support our national customer base. The Field Service Technicians (FST) are strategically positioned to meet the response time requirements of our customer's and reside near each customer location. FSTs are all required to have extensive telecommunication background and are Securus-certified to service our product offerings. The FSTs have direct access to senior technical support and engineering resources to expedite repairs and minimize customer downtime.

Workflow

Once our centralized Technical support operation determines that an issue requires on-site service, our dispatch team contacts the assigned FST and establishes an estimated time of arrival. The Dispatcher or the FST immediately communicate the time of arrival to the facility. Upon arrival at the facility, the FST will meet with the primary site contact to review the problem and perform the necessary repairs. Repairs typically involve repairing or replacing a defective part or wiring or correcting configuration settings.

Upon resolving the primary issue, the Field Service Technician will perform a system check to detect any unreported issues and conduct preventative maintenance checks while on-site, including:

- Cleaning out the system filters
- Testing system features and functionality
- Testing of individual phones

- Performing workstation(s) inspections.

Problems identified during this check are addressed by the Field Service Technician during the same visit unless additional parts are required to resolve the issue.

Upon completion of the repairs, the FST will validate problem resolution with the primary site contact and obtain sign-off on the repairs performed. After obtaining sign-off, the FST will record the transaction in our problem management system through his or her laptop.

Service Parts

Securus field service technicians maintain a working level of spare parts for minor repairs consisting of telephone sets, handsets, dials, and replacement circuit boards, either on-site or in their truck. If a technician does not have required a part, Securus will drop-ship the item to the site. Securus will ship counter-to-counter on the same day in critical situations.

Quality

Securus sends an e-mail customer satisfaction survey to the primary site contact following each service event. Customer concerns are immediately escalated to the Regional Service Manager and the National Service Director. The Regional Service Manager is required to contact the customer within 24 hours to better understand the concern and implement a correct action plan. Securus executives review the summary of each issue along with the corrective actions on a monthly basis. Our current survey results show 94% satisfaction with Field Service with 77% indicating they were “delighted” with the service they received.



Implementation

Our preliminary implementation plan includes transitional meetings that detail the setup of proposed applications and tasks associated with the transition from the current system to Securus' Secure Call Platform (SCP). Securus has extensive experience preparing locations for system implementation without disrupting the facility's existing service. All hardware, phone lines, and workstations will be in place before replacing the telephone instruments and cutting over to SCP.

A. Priority Level 1 includes, but is not limited to the following:

1. Loss of critical functionality
2. 50% or more phones in a facility out of service
3. Loss of administrative or investigative access or function
4. Loss of monitoring or recording function

Performance Standard: The time requirement for resolution of Level 1 Problems is
4 hours.

SECURUS HAS READ, AGREES AND WILL COMPLY WITH THIS REQUIREMENT.

- **Meantime To Repair SLA's:** (Based on severity of issue - from first contact till resolved)

Priority	SVV/ConnectUs Related Issues	All Other Types	DOCCS Level	Description
1	4 Hours	2 Hours	Level 1 & 2	30% or more system functionality adversely affected
2	12 Hours	24 Hours	Level 3	5%-29% system functionality adversely affected
3	24 Hours	72 Hours	Level 4	Less than 5% system functionality adversely affected
4	36 Hours	72 Hours	Level 5	All other system issues

B. Priority Level 2 includes, but is not limited to the following:

1. Loss of significant functionality
2. Data exchange failure
3. 20%--49% of phones in a facility out of service

Performance Standard: The time requirement for resolution of Level 2 Problems is
8 hours.

SECURUS HAS READ, AGREES AND WILL COMPLY WITH THIS REQUIREMENT.

- **Meantime To Repair SLA's:** (Based on severity of issue - from first contact till resolved)

Priority	SVV/ConnectUs Related Issues	All Other Types	DOCCS Level	Description
1	4 Hours	2 Hours	Level 1 & 2	30% or more system functionality adversely affected

2	12 Hours	24 Hours	Level 3	5%-29% system functionality adversely affected
3	24 Hours	72 Hours	Level 4	Less than 5% system functionality adversely affected
4	36 Hours	72 Hours	Level 5	All other system issues

C. Priority Level 3 includes, but is not limited to the following:

1. Loss of insignificant functionality
2. Software fixes not critical to operations
3. Individual phones representing 10%—20% of phones in a facility
4. Loss of trouble ticket system

Performance Standard: The time requirement for resolution of Level 3 Problems is
24 hours.

SECURUS HAS READ, AGREES AND WILL COMPLY WITH THIS REQUIREMENT.

- **Meantime To Repair SLA's:** (Based on severity of issue - from first contact till resolved)

Priority	SVV/ConnectUs Related Issues	All Other Types	DOCCS Level	Description
1	4 Hours	2 Hours	Level 1 & 2	30% or more system functionality adversely affected
2	12 Hours	24 Hours	Level 3	5%-29% system functionality adversely affected
3	24 Hours	72 Hours	Level 4	Less than 5% system functionality adversely affected
4	36 Hours	72 Hours	Level 5	All other system issues

D. Priority Level 4 includes, but is not limited to the following:

1. Individual phones representing less than 10% of phones in a facility

Performance Standard: The time requirement for resolution of Level 4 Problems is
48 hours.

SECURUS HAS READ, AGREES AND WILL COMPLY WITH THIS REQUIREMENT.

- **Meantime To Repair SLA's:** (Based on severity of issue - from first contact till resolved)

Priority	SVV/ConnectUs Related Issues	All Other Types	DOCCS Level	Description
----------	------------------------------	-----------------	-------------	-------------

1	4 Hours	2 Hours	Level 1 & 2	30% or more system functionality adversely affected
2	12 Hours	24 Hours	Level 3	5%-29% system functionality adversely affected
3	24 Hours	72 Hours	Level 4	Less than 5% system functionality adversely affected
4	36 Hours	72 Hours	Level 5	All other system issues

E. Priority Level 5 includes, but is not limited to the following:

1. Represent scheduled maintenance activities and scheduled installation or removal of equipment

Performance Standard: The time requirement for resolution of Level 5 is **five working days**.

SECURUS HAS READ, AGREES AND WILL COMPLY WITH THIS REQUIREMENT.

- **Meantime To Repair SLA's:** (Based on severity of issue - from first contact till resolved)

Priority	SVV/ConnectUs Related Issues	All Other Types	DOCCS Level	Description
1	4 Hours	2 Hours	Level 1 & 2	30% or more system functionality adversely affected
2	12 Hours	24 Hours	Level 3	5%-29% system functionality adversely affected
3	24 Hours	72 Hours	Level 4	Less than 5% system functionality adversely affected
4	36 Hours	72 Hours	Level 5	All other system issues

5.2.1 Failure to comply

After three occurrences when 50% or more of the phones in a correctional facility are out of service for more than four (4) hours at an affected facility, DOCCS may impose a remedial measure that will include free calling at the facility for the number of hours corresponding with the out-of-service lapse of time. Contractor will provide supporting documentation to demonstrate free calling provided.

SECURUS HAS READ, AGREES AND WILL COMPLY WITH THIS REQUIREMENT.

5.2.2 Escalation Requirements

Time	Escalation Point	DOCCS Contact Point
------	------------------	---------------------

Missed performance standard	Supervisor	TBD
Missed performance standard + two (2) hours	Manager	TBD
Missed performance standard + four (4) hours	Director	TBD
Missed performance standard + six (6) hours	Vice President	TBD

The vendor must establish procedures that provide, at a minimum, escalation to agreed-upon points of contact for the timeframes indicated above.

SECURUS HAS READ, AGREES AND WILL COMPLY WITH THIS REQUIREMENT.

5.3 Performance Reviews

The vendor shall provide monthly, quarterly, and annual performance reports that meet DOCCS' specifications. The reports will include the data elements noted in Section 5 above along with the raw numbers used to achieve the percentages. Additionally, every quarter, the vendor shall provide a face-to-face review of all performance indicators and trends and a summary of service issues. The vendor shall provide an annual review of the operational status, the financial status, the cost and rate analysis as well as an overall contract review. All reports and reviews will be presented to DOCCS' staff.

Provide examples of draft reports.

SECURUS HAS READ, AGREES AND WILL COMPLY WITH THIS REQUIREMENT.

Please see section/tab – REQUESTED DOCUMENTATION - - Sample Performance Review, (page 531)

END OF SECTION 5: PERFORMANCE REQUIREMENTS

6 Vendor Qualifications

6.1 Company Experience

The bidder shall submit satisfactory evidence that, in the sole judgment of DOCCS, it has at least three (3) years current experience providing ITS production systems and services for commercial or government clients. The proposed system must be a commercially available system and have been in full production for at least one (1) year for at least three (3) customers that serve at least a total of 500 inmate telephones each.

The bidder shall **submit three (3) client references** to support their experience claims. Incomplete or incorrect client contact information will be evaluated to the bidder's detriment. Current employees of DOCCS may not be used as references. **Bidders should advise proposed references that DOCCS will be calling them and confirm the references willingness to participate. The information must be provided using Appendix F, Vendor Reference Form.**

New York State will not be a test site for unproven technology. For all technology proposed, your references must include at least two sites where this technology has been in service as an integrated part of the inmate phone system for at least six (6) months. An onsite or real-time demonstration of the technology must be provided prior to finalization of the scoring for this procurement.

The subcontractors that will be used to perform any aspect of the work must complete Appendix F by providing three (3) references in the relative field of services. In addition, subcontractors must have at least three (3) years current experience providing the services in the specific field of service.

Provide the names of any federal, state or local correctional facilities and/or systems where the subcontractors' services have been used in the past three (3) years.

SECURUS HAS READ, AGREES AND WILL COMPLY WITH THIS REQUIREMENT.

Please see three (3) client references using Appendix F in section / tab – COMPLETED FORMS, (page 643)

6.2 Past Performance

6.2.1 Security Incidents

Provide details on all incidents of security breaches, lost or misused data in last three (3) years including, but not limited to, the nature and extent of the incident, remedial actions taken, and current status.

SECURUS HAS READ, AGREES AND WILL COMPLY WITH THIS REQUIREMENT.

Certain ICS providers would like you to believe that Securus was “hacked” based on an article that appeared last November in *The Intercept*. After this article was published, Securus retained outside counsel to conduct an independent investigation of the allegations appearing in the article. Counsel's investigation team included world renowned

forensic experts. After an exhaustive investigation, the team concluded that no system or database of Securus was “hacked” or otherwise unlawfully accessed, much less that inmate recordings or other data in a Securus system or database was unlawfully listened to, copied, read, or otherwise “stolen.” Rather, the investigators determined that the data/database at issue was on a third party platform over which Securus had absolutely no ownership or operational control. Further, although this third party system was unlawfully accessed (by someone unlawfully obtaining an id and password to access the system), there is no evidence that inmate call recordings or other data were actually listened to, copied, read, or otherwise “stolen.” So it is manifestly false to claim that a Securus database or system was “hacked” and our data was “stolen.” No Securus system or database has ever been “hacked” or otherwise unlawfully accessed.

6.2.2 Performance Data

Provide detailed performance information for the three (3) referenced systems identified in Section 6.1. At a minimum the performance information shall include the items identified in Section 5.1,

SECURUS HAS READ, AGREES AND WILL COMPLY WITH THIS REQUIREMENT.

Please see three (3) client references using Appendix F in section / tab – COMPLETED FORMS (page 643)

6.2.3 Legal Validity

Provide documentation of the validity of its chain of evidence methodology and its acceptance in legal proceedings. Include the number of legal cases in last three (3) years where the methodology was successful, and explain any instances where the validity of the chain of evidence was not accepted.

SECURUS HAS READ, AGREES AND WILL COMPLY WITH THIS REQUIREMENT.

Securus has been subpoenaed to testify 706 times in the past three years. Law enforcement officers all over the country are also called to testify, and Securus has no record on how many times this methodology is used in legal proceedings. We are unaware of any instances where the validity of the chain of evidence was not accepted.

Tamper Proof

File type preserves Chain of Custody requirements and thus is suitable for court evidence. This format contains internal codes to playback calls and to prevent tampering. Should tampering occur, the file becomes corrupt and is not playable at the point of the tampering.

Inmate Name Verification

Securus Secure Call Platform (SCP) allows inmates to record their name, associated with their custody account and PIN, once. The recorded name is played on all calls the inmate makes with their PIN. If PINs are not required, the system will ask the inmate to state their name on each call, the recording of which is then played to the called party. All pre-recorded inmate names are to be played to the called party when announcing the call.

For maximum flexibility, this function is configurable to use pre-recorded names, or not per inmate, facility, and customer level. A pre-recorded name may also be reset, forcing the inmate to record their name again.

This feature eliminates inmate's ability to pass messages without paying for the call. The inmate is given a custody account number for identification and is present on each call record and can be found on each call detail record. This chain of evidence verifies the call was made by that inmate.

Prevent Inmate from Passing Messages

Calls placed through the Securus Secure Call Platform (SCP) are processed through an automated attendant. SCP will not establish a two-way talk path until the called party agrees to accept the call by pressing the proper key on their telephone keypad.

Inmates have taken advantage of systems that allow them to record their name each time they place a call. Instead of recording their name, inmates have used this functionality to pass short messages to called parties without paying for the call. Some will even pass threats or harass victims or witnesses before the called party is even aware who is calling.

For these reasons, Securus recommends recording the inmate name one time and associating it to a unique PIN assigned to each inmate. This prerecorded name announcement is usually recorded in the presence of a correctional officer to ensure it is the inmate's real name and will be clearly understood by the called party. Whenever the inmate places a call using their PIN, their approved prerecorded name announcement will be played for the called party. The inmate will have no opportunity to pass any message until the called party accepts the call and billing begins.

The Securus Secure Calling Platform (SCP) provides a patented method for ensuring the authenticity of inmate call recordings made through the platform. This security feature—the Chain of Evidence—is a key component of SCP and is automatically included in all installations. The Chain of Evidence prevents tampering with the call detail record and call recording. SCP encrypts, time-stamps, and verifies the authenticity of each recording.

SCP meets or exceeds the Rules of Evidence used in state and federal courts for the admissibility and authenticity required in a court of law.

In addition to the Chain of Evidence provided through SCP, Securus will provide expert staff to testify, at no cost to DOCCS, to the authenticity of the call recordings made on SCP.

Chain of Evidence

A phone call made on the Securus SCP creates a record, known as a call detail record (CDR), which includes—at a minimum—the following information:

- Customer name
- Facility name
- Originating station
- Destination number
- Start and stop time of the call
- PIN, if used by the facility

This information provides context information about the call. It is this context that differentiates a typical recording from one that can survive an evidentiary challenge to its authenticity. SCP combines this contextual information with the audio data in memory and writes the information to disk as a continuous data stream. It is not possible to modify the recording after recording to disk, and each recording contains the critical information about the authenticity of the data.

Storing this data in one combined unit creates a strong audit trail for identifying and proving the origin of the recorded call.

Creating the Audio Data

The recording process starts as soon as the called party answers the phone. This provides a record of the entire interaction between the SCP and the called party before the called party accepts the call. This interaction includes everything the called party says and all voice-over announcements, including the following information:

- Location of the originating call
- Inmate name
- Call rates
- Call acceptance
- Notification messages, such as the standard announcement that the call is subject to monitoring and recording

The recording is “complete” in real time and does not depend on the inmate and called party ending the call to have a “header” or other information written into the CDR. This feature is significant because the recording package is constructed real-time throughout

the call and is un-editable, or locked, with all of the required data to identify the call. This guarantees that any recording produced for legal purposes is the original data (recording and call details) and cannot be modified.

Downloading Calls as Evidence

SCP allows authorized users to copy recorded conversations to any external media device connected to the user's PC, such as CD, DVD, mp3 player, or USB drive. This feature facilitates easy sharing of recordings for investigative or court purposes. To maintain the accuracy of data and recordings during downloading and copying, SCP stores the files—both audio and CDR information—embedded within an industry-standard read-only format that prevents the possibility of tampering.

"I estimate that I request phone records for eight out of every ten subjects I investigate, and of the 100 subjects that I have helped convict over the past four years, probably half of those were because of telephone recordings provided by the Securus platform. Securus has been so successful in assisting with my cases that the US Attorney's Office has asked me to get inmate calls for all cases."

- Master Police Detective Michael Wachsmuth, a Tactical Field Officer working with the Alcohol, Tobacco, and Firearms division of the Federal Justice Department.

6.3 Staff Qualifications

Provide information regarding the qualifications and experience of the individuals that will be the primary points of contact for both customer and technical services as outlined in [Section 4.1.1](#). Provide résumés and completed (Appendix G) for at least three reference projects/assignments. Include the dates of the relevant experience in the résumés and qualification forms.

6.3.1 Staffing Numbers and Qualifications

Provide the following:

- The number of staff by functional area, work shift, average years of experience and turnover rates for the last three (3) years
- The ratio of customer service staff to the number of active accounts
- The ratio of the number of technical support staff to the number of installed sites

SECURUS HAS READ, AGREES AND WILL COMPLY WITH THIS REQUIREMENT.

Count of Last Name		Total
Aux 2	Home Department	Total
ARCHONIX	000870 - ARCHONIX - TN XJAIL	13
	000875 - ARCHONIX - NJ XGEN	14
	000880 - ARCHONIX - PAMET	4
	000890 - ARCHONIX - MN EMR	11
	000895 - ARCHONIX - EMR Shared Serv	3
ARCHONIX Total		45
CEO	000070 - CEO	2
CEO Total		2
CFO	000040 - CFO - Purchasing	2
	000072 - BUS ANALYSIS - Bus Unit	5
	000073 - CFO - Billing Operations	11
	000076 - CFO - Accounting	28
	000078 - CFO - Business Analysis	9
CFO Total		55
CORP DEVELOP	000030 - CORP DEVELOP	13
CORP DEVELOP Total		13
CUSTOMER CARE	000092 - CUSTOMER CARE - Call Cente	113
	000110 - CUSTOMER CARE - Ops Mgmt	6
	000112 - Client Management East	7
	000114 - CUSTOMER CARE - Reporting	6
	000116 - Client Management West	9
	000151 - CUSTOMER CARE - Temp	24
CUSTOMER CARE Total		165
GUARDED EXCHANGE	000912 - GEX - Investigative Soluti	75
	000913 - GEX - Overhead	4
	000914 - GEX - Digital Forensi	5
GUARDED EXCHANGE Total		84
HR	000074 - HR - Human Resources	11
	000094 - HR - Facilities	2
HR Total		13
IT - CIO	000032 - IT - Enterprise Mgmt Sys	29
	000033 - IT - Enterprise Operations	10
	000036 - IT - Security	8
	000037 - IT - CIO	1
IT - CIO Total		48
IT - NETWORK OPERATIONS	000038 - IT - Network Operations	6
	000059 - OPS - Systems	9
	000060 - OPS - Network	13
	000075 - OPS - Telecom Services	11
	000098 - OPS - Data Center & NOC	19
	000906 - MAS - Vanu	4
	000907 - MAS Cellblox	5
IT - NETWORK OPERATIONS Total		67
IT - VP APPLICATIONS	000031 - IT - SCN	60
	000034 - IT - Architecture & Capcty	18
	000035 - IT - VP Applications	1
	000050 - IT - VP Applications	10

Count of active accounts vs. Customer Service staff: **14483:1**

Count of installed sites vs. Technical Support/Install: **18:1**

Count of installed sites vs. Technical Support/Install/Field: **6:1**

Count details:

- Total sites: 1915
- TS/IS: 107
- FS: 221

Please see résumés and completed Staff Qualification Forms (Appendix G) in section / tab – COMPLETED FORMS (page 643)

6.3.2 Staff Disqualification

DOCCS shall have the right to require the contractor to remove any individual assigned to this project at any time during the term of this contract at DOCCS' sole discretion.

SECURUS HAS READ, AGREES AND WILL COMPLY WITH THIS REQUIREMENT.

6.3.3 Staff Resignation or Discharge

The contractor shall immediately notify DOCCS of the resignation or discharge of the primary points of contact assigned to this project. Transfer of knowledge must occur prior to the departure of any staff members. The contractor shall propose a qualified replacement for DOCCS' review and approval.

SECURUS HAS READ, AGREES AND WILL COMPLY WITH THIS REQUIREMENT.

6.4 Vendor Responsibility

6.4.1 Vendor Responsibility Requirements

DOCCS conducts a review of prospective contractors ("Bidders") to provide reasonable assurances that the Bidder is responsive and responsible. A Vendor Responsibility Questionnaire is used for non-construction contracts and is designed to provide information to assess a Bidder's responsibility to conduct business in New York based upon financial and organizational capacity, legal authority, business integrity, and past performance history. By submitting a bid, Bidder agrees to fully and accurately complete the Vendor Responsibility Questionnaire. The Bidder acknowledges that the State's execution of the Contract will be contingent upon the State's determination that the Bidder is responsible, and that the State will be relying upon the Bidder's responses to the questionnaire when making its responsibility determination. See Appendix E for details.

The bidder agrees that if it is found by the State that the bidder's responses to the questionnaire were intentionally false or intentionally incomplete, on such finding, DOCCS will terminate the Contract. In no case shall such termination of the Contract by the State be deemed a breach thereof, nor shall the State be liable for any damages for lost profits or otherwise, which may be sustained by the Contractor as a result of such termination.

The Contractor shall at all times during the Contract term remain responsible. The Contractor agrees, if requested by the Commissioner of DOCCS or his designee, to present evidence of its continuing legal authority to do business in New York State, integrity, experience, ability, prior performance, and organizational and financial capacity.

The DOCCS' Commissioner or his designee, in his or her sole discretion, reserves the right to suspend any or all activities under this Contract, at any time, when he or she discovers information that calls into question the responsibility of the Contractor. In the event of such suspension, the Contractor will be given written notice outlining the particulars of such suspension. Upon issuance of such notice, the Contractor must comply with the terms of the suspension order. Contract activity may resume at such time as the DOCCS' Commissioner or his designee issues a written notice authorizing a resumption of performance under the Contract.

SECURUS HAS READ, AGREES AND WILL COMPLY WITH THIS REQUIREMENT.

Please see section/tab – COMPLETED FORMS – Vendor Responsibility Questionnaire (page 643)

6.4.2 Complaint History

The vendor shall **provide full disclosure of complaints lodged against it to the Better Business Bureau, the FCC, any state public service commissions or similar agency and any state Attorneys General within the last three (3) years.**

SECURUS HAS READ, AGREES AND WILL COMPLY WITH THIS REQUIREMENT.

BBB Complaints

State	Escalation Type	Customer Name	Phone Number	Complaint	Received	Resolved	Explanation of Resolution
WI	BBB	Cint Sizewski	608-430-XXXX	Billing Dispute	1/3/2014	1/10/2014	Satisfactorily Resolved
TX	BBB	Ron Greenthaler	817-526-XXXX	Instant Pay/NowText2Connect/FCC	1/3/2014	1/10/2014	Satisfactorily Resolved
KY	BBB	Linda Sue Garcia	502-257-XXXX	Refund Not Received; inability to Talk to Rep - IVR	1/8/2014	1/15/2014	Satisfactorily Resolved
NY	BBB	Jasmine Gray	954-536-XXXX	Cut Off Calls (COC); Failure to escalate within CBS	1/9/2014	1/16/2014	Satisfactorily Resolved
WI	BBB	Amy Lynn Swietczak	414-678-XXXX	Payment Not Posted; Failure to escalate within CBS	1/14/2014	1/21/2014	Satisfactorily Resolved
FL	BBB	Jennifer Garke	727-277-XXXX	180-Day Policy; Failure to escalate within CBS	1/14/2014	1/21/2014	Satisfactorily Resolved
TX	BBB	Gina Morgan	936-666-XXXX	Billing Dispute	1/16/2014	1/23/2014	Satisfactorily Resolved
FL	BBB	Xiomara Chevas	770-784-XXXX	Customer Not Getting Calls (CNGC)	1/17/2014	1/24/2014	Satisfactorily Resolved
IA	BBB	Melissa Edwards	712-276-XXXX	180-Day Policy	1/22/2014	1/29/2014	Satisfactorily Resolved
IA	BBB	Brian Huckfeldt	515-447-XXXX	Cut Off Calls (COC)	1/27/2014	2/3/2014	Satisfactorily Resolved
GA	BBB	Laketa Rhodes	515-447-XXXX	Cut Off Calls (COC)	1/28/2014	2/4/2014	Satisfactorily Resolved
IL	F&F	Rose Kovenko	773-774-XXXX	Unwanted calls	1/2/2014	1/9/2014	Satisfactorily Resolved
MO	F&F	Ashley Frazer	816-679-XXXX	Payment Not Posted; inability to Talk to Rep - IVR	1/3/2014	1/10/2014	Satisfactorily Resolved
IL	F&F	Trishawn Hudson	719-929-XXXX	Cut Off Calls (COC); inability to Talk to Rep - IVR	1/10/2014	1/17/2014	Satisfactorily Resolved
IL	F&F	Mr. Whitney	Inmate Complaint #B023940	Payment Not Posted	1/10/2014	1/17/2014	Satisfactorily Resolved
IL	F&F	Rosalind Smith	773-966-XXXX	Cut Off Calls (COC)	1/13/2014	1/20/2014	Satisfactorily Resolved
WI	F&F	Paul Nowak	414-708-XXXX	Unwanted calls; inability to Talk to Rep - IVR	1/13/2014	1/20/2014	Satisfactorily Resolved
CA	F&F	Randall Stephens	209-785-XXXX	Fraud	1/13/2014	1/20/2014	Satisfactorily Resolved
CA	F&F	Robert Fiore	951-385-XXXX	High Rates	1/14/2014	1/21/2014	Satisfactorily Resolved
FL	F&F	Karin Berry	954-507-XXXX	Payment Issue; inability to Talk to Rep - IVR	1/14/2014	1/21/2014	Satisfactorily Resolved
TX	F&F	Janet O Bryant	936-444-XXXX	Bill Copy Request	1/15/2014	1/22/2014	Satisfactorily Resolved
MI	F&F	Donna Ullom	231-218-XXXX	Cut Off Calls (COC)	1/21/2014	1/28/2014	Satisfactorily Resolved
TX	F&F	Audy Tankerby	909-982-XXXX	Payment Issue	1/23/2014	1/30/2014	Satisfactorily Resolved
WA	F&F	Maggie DeLeon	509-910-XXXX	Inmate Debit	1/23/2014	1/30/2014	Satisfactorily Resolved
MO	F&F	Sharon Brown	573-803-XXXX	Credit Card Fraud	1/23/2014	1/30/2014	Satisfactorily Resolved
TX	F&F	Bertie Johnson	979-540-XXXX	Customer Not Getting Calls (CNGC)	1/28/2014	2/4/2014	Satisfactorily Resolved
CT	BBB	Quanel Spearman	Inmate Complaint	Payment Not Posted	2/5/2014	2/12/2014	Satisfactorily Resolved
SC	BBB	Brett Spencer	849-336-XXXX	Billing Dispute	2/10/2014	2/17/2014	Satisfactorily Resolved
IL	BBB	Gift Onyento	773-443-XXXX	Billing Dispute; inability to Talk to Rep	2/11/2014	2/18/2014	Satisfactorily Resolved
IL	BBB	Willie Dodd	Inmate Complaint	Refund Not Received	2/14/2014	2/21/2014	Satisfactorily Resolved
MO	BBB	Jeffrey Klingler	417-581-XXXX	Billing Dispute	2/14/2014	2/21/2014	Satisfactorily Resolved
GA	BBB	Nelia (Antonella) Neely	770-249-XXXX	Rate Dispute	2/14/2014	2/21/2014	Satisfactorily Resolved
IN	BBB	Stacey Slack	812-531-XXXX	Rate Dispute	2/17/2014	2/24/2014	Satisfactorily Resolved
IL	BBB	Joyce McCall	309-526-XXXX	Billing Dispute; inability to Talk to Rep	2/19/2014	2/25/2014	Satisfactorily Resolved
TX	BBB	Ricardo Beer	432-238-XXXX	escalate within CBS	2/20/2014	2/27/2014	Satisfactorily Resolved
CA	BBB	Porsha Matthews	520-413-XXXX	Cut Off Calls	2/24/2014	3/3/2014	Satisfactorily Resolved
OK	BBB	Ashley Abbott	918-557-XXXX	Payment Not Posted	2/25/2014	3/4/2014	Satisfactorily Resolved
NE	BBB	Pamela Cox	402-203-XXXX	Payment Issue	2/27/2014	3/6/2014	Satisfactorily Resolved
FL	BBB	Line St-Amant	954-857-XXXX	Cut Off Calls (COC)	2/27/2014	3/6/2014	Satisfactorily Resolved
TX	F&F	Gertha Johnson	979-540-XXXX	Payment Issue	2/6/2014	2/13/2014	Satisfactorily Resolved
NH	F&F	Fawn Jelonowski	603-947-XXXX	Customer not Getting Calls; Rude Rep; Inquiry	2/10/2014	2/17/2014	Satisfactorily Resolved
WI	F&F	Vicki Mitchell	920-779-XXXX	Payment Not Posted	2/17/2014	2/24/2014	Satisfactorily Resolved
KY	F&F	Wanda West	606-549-XXXX	Payment Not Posted; inability to Talk to Rep	2/19/2014	2/26/2014	Satisfactorily Resolved
FL	F&F	Gary Perkins	772-408-XXXX	Customer not Getting Calls	2/21/2014	2/28/2014	Satisfactorily Resolved
TX	F&F	Brandy Khond	832-744-XXXX	Refund Not Received	2/24/2014	3/3/2014	Satisfactorily Resolved
IL	F&F	Demetrius Whitney	Inmate Complaint	Inquiry	2/25/2014	3/4/2014	Satisfactorily Resolved
SC	F&F	Joseph May	864-980-XXXX	Unwanted calls	2/28/2014	3/7/2014	Satisfactorily Resolved
TN	F&F	Jack Ollahan	423-284-XXXX	SVV: Visit Issues	2/28/2014	3/7/2014	Satisfactorily Resolved

FL	BBB	Carol Ann Stuart	810-623-XXXX	Customer not Getting Calls; High Rates; Cannot reach CSR Hold Time	3/5/2014	3/12/2014	Satisfactorily Resolved
TX	BBB	Felicita Coe	806-894-XXXX	Unwanted calls - CBS giving wrong information; Rude Rep Out Off Calls (COC); Rate Dispute; Failure to escalate within CBS	3/10/2014	3/17/2014	Satisfactorily Resolved
TN	BBB	Shannon Thompson	931-266-XXXX	Customer not Getting Calls	3/10/2014	3/17/2014	Satisfactorily Resolved
MI	BBB	Susan Reed	313-846-XXXX	Cut Off Calls (COC)	3/10/2014	3/17/2014	Satisfactorily Resolved
CA	BBB	Porsha Matthews	818-579-XXXX	Billing Dispute	3/11/2014	3/18/2014	Satisfactorily Resolved
TX	BBB	Zerick Waites	214-388-XXXX	Cut Off Calls (COC);	3/11/2014	3/18/2014	Satisfactorily Resolved
TN	BBB	Teri Rowe	423-320-XXXX	Customer not Getting Calls	3/14/2014	3/21/2014	Satisfactorily Resolved
CO	BBB	Sharalynn Rocha	303-759-XXXX	Payment Issue	3/19/2014	3/26/2014	Satisfactorily Resolved
WI	BBB	Lindsey Thompson	715-213-XXXX	Cut Off Calls (COC)	3/19/2014	3/26/2014	Satisfactorily Resolved
TX	BBB	Kerrie Gray	832-306-XXXX	Cut Off Calls (COC)	3/20/2014	3/27/2014	Satisfactorily Resolved
FL	BBB	T Hamlette	954-243-XXXX	Refund	3/28/2014	4/4/2014	Satisfactorily Resolved
CT	BBB	Matthew Durant	860-888-XXXX	Customer not Getting Calls	3/4/2014	3/11/2014	Satisfactorily Resolved
VA	F&F	Moses Burton	757-279-XXXX	Account Set Up	3/4/2014	3/11/2014	Satisfactorily Resolved
FL	F&F	Carol Ann Stuart	239-935-XXXX	Payment Not Posted	3/7/2014	3/14/2014	Satisfactorily Resolved
TX	F&F	Lottie Everett	817-823-XXXX	Refund Not Received	3/10/2014	3/17/2014	Satisfactorily Resolved
MI	F&F	Barbara Gaines	269-561-XXXX	Billing Dispute; Failure to escalate within CBS; Rude Rep	3/10/2014	3/17/2014	Satisfactorily Resolved
TX	F&F	Brittany Davis	832-567-XXXX	Customer not Getting Calls	3/12/2014	3/19/2014	Satisfactorily Resolved
NY	F&F	Denise Ditroia	718-864-XXXX	Deny All Knowledge; Customer not Getting Calls	3/19/2014	3/26/2014	Satisfactorily Resolved
OR	F&F	Marna Barnes	503-326-XXXX	Rude Rep	3/19/2014	3/26/2014	Satisfactorily Resolved
DC	F&F	Stephanie Nielsen	202-797-XXXX	Inquiry	3/20/2014	3/27/2014	Satisfactorily Resolved
TX	F&F	Chinyere Akabueze	832-881-XXXX	Inquiry	3/21/2014	3/28/2014	Satisfactorily Resolved
TX	F&F	Gerrude Richardson	903-654-XXXX	Cut Off Calls (COC)	3/25/2014	4/1/2014	Satisfactorily Resolved
NC	F&F	Steve Coon	828-271-XXXX	Video Visitation	3/25/2014	4/1/2014	Satisfactorily Resolved
GA	F&F	Patricia Jackson	478-978-XXXX	Customer not Getting Calls	3/26/2014	4/2/2014	Satisfactorily Resolved
IN	F&F	Christopher Alinyemi	317-981-XXXX	Payment Issue	3/26/2014	4/2/2014	Satisfactorily Resolved
MD	F&F	n/s	301-356-XXXX	Cut Off Calls (COC)	3/26/2014	4/2/2014	Satisfactorily Resolved
FL	F&F	Cecilia Lozano	239-633-XXXX	Customer not Getting Calls	3/27/2014	4/3/2014	Satisfactorily Resolved
CT	F&F	Christine Powell	203-727-XXXX	Refund Not Received	3/28/2014	4/4/2014	Satisfactorily Resolved
IN	F&F	Christopher Alinyemi	317-981-XXXX	Payment Issue	4/2/2014	4/9/2014	Satisfactorily Resolved
TX	F&F	Bettie Cox	903-984-XXXX	Account Set Up	4/2/2014	4/9/2014	Satisfactorily Resolved
GA	F&F	Patricia Jackson	478-978-XXXX	Account Set Up	4/3/2014	4/10/2014	Satisfactorily Resolved
TX	BBB	Melissa Sanders	832-851-XXXX	180-Day Policy	4/3/2014	4/10/2014	Satisfactorily Resolved
IL	BBB	Kristina Rutherford	309-231-XXXX	Refund	4/7/2014	4/14/2014	Satisfactorily Resolved
NM	BBB	Sue Vigil	505-426-XXXX	Out Off Calls (COC) - Cellular	4/8/2014	4/15/2014	Satisfactorily Resolved
WI	BBB	Patrick Chirco	502-883-XXXX	Fees: Payment/Funding	4/8/2014	4/15/2014	Satisfactorily Resolved
TX	BBB	Steven Voll	not provided	Customer Not Getting Calls (CNSG)	4/10/2014	4/17/2014	Satisfactorily Resolved
WA	BBB	Ashley Johnson	253-332-XXXX	Fees	4/11/2014	4/18/2014	Satisfactorily Resolved
NY	BBB	Michelle Heckman	917-755-XXXX	Payment Not Getting Calls (CNSG)	4/11/2014	4/18/2014	Satisfactorily Resolved
IL	BBB	Nicole Larrea	773-757-XXXX	Payment Not Getting Calls (CNSG)	4/11/2014	4/18/2014	Satisfactorily Resolved
WI	BBB	Steven Doers	920-317-XXXX	Payment Not Getting Calls (CNSG)	4/11/2014	4/18/2014	Satisfactorily Resolved
TX	BBB	Barry Monteurud	214-558-XXXX	Payment Not Posted	4/11/2014	4/18/2014	Satisfactorily Resolved
OK	BBB	Mallinda Brooks	580-706-XXXX	Customer Not Getting Calls (CNSG)	4/14/2014	4/21/2014	Satisfactorily Resolved
WA	BBB	Larry Iac Kanber	425-350-XXXX	Payment Not Getting Calls (CNSG)	4/22/2014	4/29/2014	Satisfactorily Resolved
WI	BBB	Amy Lynn Swiatczak	414-678-XXXX	Out Off Calls (COC) - Cellular	4/22/2014	4/29/2014	Satisfactorily Resolved
TX	BBB	Clinton Geer	928-210-XXXX	Customer Not Getting Calls (CNSG)	4/23/2014	4/30/2014	Satisfactorily Resolved
GA	BBB	Sabra Ibell	414-678-XXXX	Customer Not Getting Calls (CNSG)	4/23/2014	4/30/2014	Satisfactorily Resolved

MI	BBB	Katherine McCalland	249-366-XXXX	Customer Not Getting Calls (CNGC)	4/25/2014	5/2/2014	Satisfactorily Resolved
FL	BBB	Brittany Wilson	561-376-XXXX	Out Off Calls (COC) - Cellular	4/28/2014	5/5/2014	Satisfactorily Resolved
OH	BBB	Alberta Bell	937-270-XXXX	Out Off Calls (COC) - Cellular	4/29/2014	5/6/2014	Satisfactorily Resolved
VA	BBB	Donna Glick	540-740-XXXX	Fraud	4/30/2014	5/7/2014	Satisfactorily Resolved
LA	BBB	Terrence Anderson	Inmate Complaint	Billing Issues	4/30/2014	5/7/2014	Satisfactorily Resolved
MIN	F&F	Antoinette Scott	612-298-XXXX	Payment Issue; Failure to escalate within CBS	4/1/2014	4/8/2014	Satisfactorily Resolved
FL	F&F	Ivy Hershkowitz	305-776-XXXX	Out Off Calls (COC) - Cellular	4/8/2014	4/15/2014	Satisfactorily Resolved
AZ	F&F	Michael Pierce	602-464-XXXX	High Rates; Fees: Payment/Funding; Fees	4/8/2014	4/15/2014	Satisfactorily Resolved
OH	F&F	Dana Bookbinder	209-647-XXXX	Fraud	4/8/2014	4/15/2014	Satisfactorily Resolved
Germany	F&F	Greg Hisay	011497141918082	Inability to Talk to Rep - IVR	4/8/2014	4/15/2014	Satisfactorily Resolved
CT	F&F	Sharia Quinn	209-999-XXXX	Inability to Talk to Rep - Hold Time	4/14/2014	4/21/2014	Satisfactorily Resolved
WI	F&F	Dianne Kerstler	262-884-XXXX	Customer Not Getting Calls (CNGC)	4/14/2014	4/21/2014	Satisfactorily Resolved
TX	F&F	Dennis Dobbs	903-408-XXXX	Fraud	4/14/2014	4/21/2014	Satisfactorily Resolved
CT	F&F	Ruth Borst	860-742-XXXX	Customer Not Getting Calls (CNGC)	4/16/2014	4/23/2014	Satisfactorily Resolved
IN	F&F	Michelle Cobb	812-589-XXXX	Fraud	4/17/2014	4/24/2014	Satisfactorily Resolved
FL	F&F	Freda Holmes	727-584-XXXX	Customer Not Getting Calls (CNGC)	4/18/2014	4/25/2014	Satisfactorily Resolved
TN	F&F	David Youngdahl	423-284-XXXX	Payment Issue	4/22/2014	4/29/2014	Satisfactorily Resolved
NC	F&F	Holly Shook	828-775-XXXX	Payment Issue	4/23/2014	4/30/2014	Satisfactorily Resolved
TX	F&F	Bertie Cox	903-984-XXXX	Customer Not Getting Calls (CNGC)	4/24/2014	5/1/2014	Satisfactorily Resolved
FL	F&F	William Ferlon Carpenter	850-892-XXXX	Customer Not Getting Calls (CNGC)	4/25/2014	5/2/2014	Satisfactorily Resolved
IL	F&F	John Garda	Inmate Complaint	High Rates	4/30/2014	5/7/2014	Satisfactorily Resolved
KY	BBB	John Belden	Inmate Complaint	Secure Instant Mail (SIM)	5/1/2014	5/8/2014	Satisfactorily Resolved
SC	BBB	Devon Smith	803-369-XXXX	Secure Instant Mail (SIM); RCF (Call Diversion)	5/1/2014	5/8/2014	Satisfactorily Resolved
OK	BBB	Tina Goertz	405-592-XXXX	Out Off Calls (COC) - Cellular	5/5/2014	5/12/2014	Satisfactorily Resolved
TX	BBB	Jamie Stockstill	254-595-XXXX	Payment Issues; Rude Rep	5/6/2014	5/13/2014	Satisfactorily Resolved
NC	BBB	Tyana Bradford	980-338-XXXX	Cut Off Calls (COC) - Cellular; inability to Talk to Rep - Hold Time	5/6/2014	5/13/2014	Satisfactorily Resolved
RI	BBB	Jill Tyler	401-521-XXXX	SVV: Visit Issues	5/7/2014	5/14/2014	Satisfactorily Resolved
MT	BBB	Stacey Gasta	406-459-XXXX	Customer Not Getting Calls (CNGC); CBS giving wrong information	5/12/2014	5/19/2014	Satisfactorily Resolved
MO	BBB	Lindsay Owens	314-925-XXXX	SVV: Visit Issues; Failure to escalate within CBS	5/13/2014	5/20/2014	Satisfactorily Resolved
SC	BBB	Cassey Hilton	803-460-XXXX	Out Off Calls (COC) - Cellular	5/13/2014	5/20/2014	Satisfactorily Resolved
IL	BBB	Michael Neal	773-936-XXXX	Out Off Calls (COC) - Cellular	5/20/2014	5/27/2014	Satisfactorily Resolved
MI	BBB	Karen Robert	616-502-XXXX	Secure Instant Mail (SIM)	5/21/2014	5/28/2014	Satisfactorily Resolved
MI	BBB	Audrey Willis	989-835-XXXX	RCF (Call Diversion)	5/22/2014	5/29/2014	Satisfactorily Resolved
TX	BBB	Irene Garcia	281-704-XXXX	Out Off Calls (COC) - Cellular	5/29/2014	6/5/2014	Satisfactorily Resolved
IL	BBB	Tashona Manshall	312-859-XXXX	CBS; Rude Rep	5/29/2014	6/5/2014	Satisfactorily Resolved
TN	F&F	Sharon Michael	615-663-XXXX	Customer Not Getting Calls (CNGC)	5/1/2014	5/8/2014	Satisfactorily Resolved
TX	F&F	Dawn Nolen	512-569-XXXX	Customer Not Getting Calls (CNGC)	5/1/2014	5/8/2014	Satisfactorily Resolved
KY	F&F	Carl Casey	502-633-XXXX	Fraud	5/1/2014	5/8/2014	Satisfactorily Resolved
TX	F&F	Ramona Ponce	214-337-XXXX	Payment Issue	5/2/2014	5/9/2014	Satisfactorily Resolved
TX	F&F	Brian Ward	903-818-XXXX	Refund	5/2/2014	5/9/2014	Satisfactorily Resolved
TX	F&F	Terry Minnick	817-726-XXXX	Account Status	5/9/2014	5/16/2014	Satisfactorily Resolved
TN	F&F	Use Bursley	901-674-XXXX	Unwanted calls	5/12/2014	5/19/2014	Satisfactorily Resolved
TX	F&F	Robert Phillips	Ex Inmate	Refund	5/14/2014	5/21/2014	Satisfactorily Resolved
PA	F&F	Teresa Dolt	717-380-XXXX	Fraud	5/14/2014	5/21/2014	Satisfactorily Resolved
IN	F&F	Christopher Almyemil	317-381-XXXX	Fees	5/15/2014	5/22/2014	Satisfactorily Resolved
TX	F&F	Dave Coatsan	???	Fraud	5/15/2014	5/22/2014	Satisfactorily Resolved
MA	F&F	Marina Sheridan	978-408-XXXX	Cut Off Calls (COC) - Cellular; inability to Talk to Rep - IVR	5/19/2014	5/26/2014	Satisfactorily Resolved

MN	F&F	Carolyne White	218-732-XXXX	Customer Not Getting Calls (CNGC); Out Off Calls (COC) - Cellular; SVV: Visit Issues	5/28/2014	6/4/2014	Satisfactorily Resolved
MA	F&F	Keith Dion	774-322-XXXX	Refund	5/29/2014	6/5/2014	Satisfactorily Resolved
AR	F&F	Travis Talley	479-477-XXXX	Fraud	5/29/2014	6/5/2014	Satisfactorily Resolved
TX	F&F	Ramona Ponce	214-937-XXXX	Payment Issue	5/29/2014	6/5/2014	Satisfactorily Resolved
AZ	Better Business Bureau	Cloe Crumblay	575-538-XXXX	Billing Issues	6/2/2014	6/23/2014 14:06	Satisfactorily Resolved
IN	Better Business Bureau	Marylou Lee	815-838-XXXX	Other	6/2/2014	6/23/2014 12:00	Satisfactorily Resolved
FL	Better Business Bureau	Kristine Obot	386-503-XXXX	Prepaid Overages	6/2/2014	6/23/2014 14:05	Satisfactorily Resolved
LA	Better Business Bureau	Rachel Korisky	240-386-XXXX	Payment Issue	6/3/2014	6/23/2014 14:08	Satisfactorily Resolved
FL	Better Business Bureau	Ronilda Wood	813-569-XXXX	Payment Issue	6/4/2014	6/24/2014 16:46	Satisfactorily Resolved
IL	Better Business Bureau	Marie Amparan	708-705-XXXX	Cut Off Calls (COC) - Cellular	6/6/2014	6/24/2014 16:48	Satisfactorily Resolved
CT	Friends and Family	Laura Harrell	203-215-XXXX	Refund Issue	6/6/2014	6/16/2014 12:47	Satisfactorily Resolved
MN	Better Business Bureau	Flora Blunt	763-400-XXXX	Cut Off Calls (COC)	6/10/2014	6/25/2014 15:04	Satisfactorily Resolved
n/a	Better Business Bureau	Jeremy Jones	802-282-XXXX	Refund	6/10/2014	7/1/2014 13:45	Satisfactorily Resolved
IL	Better Business Bureau	Mary Knox	765-491-XXXX	180-Day Policy	6/11/2014	7/2/2014 15:28	Satisfactorily Resolved
FL	Better Business Bureau	Natasha Estewez	305-764-XXXX	Cut Off Calls (COC) - Cellular	6/11/2014	7/1/2014 13:43	Satisfactorily Resolved
n/a	Friends and Family	Joe Ferguson	978-483-XXXX	Unwanted Inmate Calls	6/13/2014	6/16/2014 13:10	Satisfactorily Resolved
OR	Friends and Family	Marna Barnes	503-279-XXXX	Billing Issues	6/13/2014	6/16/2014 12:45	Satisfactorily Resolved
n/a	Friends and Family	Linda Frazier	720-542-XXXX	Account Status	6/17/2014	6/20/2014 15:18	Satisfactorily Resolved
NJ	Friends and Family	Wayne Jensen	856-701-XXXX	Refund Issue	6/19/2014	6/20/2014 12:49	Satisfactorily Resolved
MI	Better Business Bureau	Jerisa Buchanan	616-514-XXXX	Cut Off Calls (COC) - Cellular	6/23/2014	7/10/2014 15:49	Satisfactorily Resolved
MI	Better Business Bureau	Trudy Jeanette Jackson	989-329-XXXX	Fees	6/23/2014	7/10/2014 15:50	Satisfactorily Resolved
WI	Better Business Bureau	Carolyn Beckwith	608-393-XXXX	Payment Not Posted	6/25/2014	7/8/2014 8:44	Satisfactorily Resolved
WI	Better Business Bureau	Marcus Finch	Inmate	Payment Not Posted	6/26/2014	7/10/2014 15:32	Satisfactorily Resolved
MA	Executive	Gail Weyant	617-325-XXXX	Customer Not Getting Calls	6/26/2014	7/15/2014 11:55	Satisfactorily Resolved
IN	Better Business Bureau	Denise Conkright	765-307-XXXX	CBS Giving Wrong Information	6/30/2014	7/14/2014 8:27	Satisfactorily Resolved
FL	Better Business Bureau	Linda Avery	301-877-XXXX	Billing Issues	7/1/2014	7/16/2014 14:04	Satisfactorily Resolved
FL	Better Business Bureau	JB Howe	850-537-XXXX	Fees	7/1/2014	7/16/2014 14:04	Satisfactorily Resolved
IL	Better Business Bureau	Dawn Durante	630-773-XXXX	180-Day Policy	7/1/2014	7/21/2014 16:33	Satisfactorily Resolved
IN	Friends and Family	Christopher Akinyemi	317-381-XXXX	Cut Off Calls (COC) - Cellular	7/1/2014	7/1/2014 16:19	Satisfactorily Resolved
SC	Better Business Bureau	Tracy Taylor	803-521-XXXX	Cut Off Calls (COC) - Cellular	7/2/2014	7/19/2014 9:48	Satisfactorily Resolved
NY	Better Business Bureau	Marchelle Dale	502-647-XXXX	Information Request	7/2/2014	7/18/2014 12:08	Satisfactorily Resolved
NC	Better Business Bureau	Kimberly Walker	336-791-XXXX	Billing Issues	7/2/2014	7/21/2014 16:44	Satisfactorily Resolved
KS	Executive	Michael Johansen	785-633-XXXX	Other	7/7/2014	7/15/2014 12:04	Satisfactorily Resolved
IL	Better Business Bureau	Warron Lowe	815-758-XXXX	Payment Not Posted	7/9/2014	7/22/2014 10:10	Satisfactorily Resolved
TX	Better Business Bureau	Loni Sprang	972-800-XXXX	Cut Off Calls (COC) - Cellular	7/9/2014	7/22/2014 10:35	Satisfactorily Resolved
TX	Better Business Bureau	Michelle Montes Martinez	817-484-XXXX	Account Status	7/9/2014	7/22/2014 10:19	Satisfactorily Resolved
AZ	Better Business Bureau	Tasha Shultz	520-499-XXXX	Cut Off Calls (COC) - Cellular	7/11/2014	7/24/2014 10:33	Satisfactorily Resolved
TX	Better Business Bureau	Destiny Bowser	512-939-XXXX	Cut Off Calls (COC) - Cellular	7/11/2014	7/24/2014 11:37	Satisfactorily Resolved
FL	Friends and Family	Marie Diaz	850-454-XXXX	Customer Not Getting Calls	7/14/2014	8/12/2014 10:36	Satisfactorily Resolved
TX	Friends and Family	Antisia Santee	281-459-XXXX	Billing Issues	7/14/2014	7/15/2014 11:49	Satisfactorily Resolved
MO	Better Business Bureau	Joseph Faith	636-675-XXXX	Customer Not Getting Calls	7/15/2014	8/1/2014 12:40	Satisfactorily Resolved
KS	Better Business Bureau	Jo Samuel	913-680-XXXX	Cut Off Calls (COC) - Cellular	7/15/2014	8/1/2014 12:48	Satisfactorily Resolved
MO	Executive	Jim Wyrnsch	314-288-XXXX	Blocked/RCF	7/15/2014	7/23/2014 15:22	Satisfactorily Resolved
IL	Executive	Bob Cherthiak	618-210-XXXX	Payment Issue	7/15/2014	8/11/2014 10:33	Satisfactorily Resolved
MO	Better Business Bureau	Stephen liberty	626-345-XXXX	Unwanted Inmate Calls	7/16/2014	7/16/2014 14:04	Satisfactorily Resolved
VA	Friends and Family	Anita Johnson	804-224-XXXX	Customer Not Getting Calls	7/17/2014	7/23/2014 15:14	Satisfactorily Resolved
AZ	Better Business Bureau	Robert Gilbertson	707-260-XXXX	Fees	7/18/2014	8/5/2014 9:52	Satisfactorily Resolved
TX	Better Business Bureau	Lacy Larson	903-871-XXXX	Billing Issues	7/21/2014	8/5/2014 10:13	Satisfactorily Resolved
WI	Better Business Bureau	Jill Kupfer	715-207-XXXX	180-Day Policy	7/22/2014	8/7/2014 16:15	Satisfactorily Resolved
KS	Friends and Family	Bonnie Lor Ing	865-425-XXXX	Refund Issue	7/22/2014	7/23/2014 15:09	Satisfactorily Resolved
OH	Friends and Family	Michelle Johnson	216-618-XXXX	Refund Issue	7/23/2014	8/18/2014 11:15	Satisfactorily Resolved
AZ	Better Business Bureau	Daryn Larson	623-335-XXXX	Blocked/RCF	7/28/2014	8/13/2014 15:46	Satisfactorily Resolved
IL	Friends and Family	Demetrius Whitney 802940	Inmate	Payment Not Posted	7/28/2014	8/11/2014 10:14	Satisfactorily Resolved
CO	Better Business Bureau	Jackie Barton	720-203-XXXX	Fees	7/29/2014	8/13/2014 15:54	Satisfactorily Resolved
TX	Executive	Sandra Jackson	830-779-XXXX	Billing Issues	7/30/2014	7/31/2014 10:24	Satisfactorily Resolved
TX	Better Business Bureau	Jenny Alyce Williams	832-312-XXXX	Inability to Talk to Rep	8/5/2014	8/19/2014 14:34	Satisfactorily Resolved
IL	Better Business Bureau	Kristina Leflore (Rutherford)	309-231-XXXX	Cut Off Calls (COC) - Cellular	8/5/2014	8/20/2014 11:04	Satisfactorily Resolved
UT	Executive	Lynsi Holland	385-319-XXXX	Other	8/5/2014	8/18/2014 13:11	Satisfactorily Resolved
FL	Better Business Bureau	Tracy Stokes	850-380-XXXX	Cut Off Calls (COC) - Cellular	8/7/2014	8/20/2014 11:03	Satisfactorily Resolved
TX	Better Business Bureau	LaRae Ford	817-703-XXXX	Payment Issue	8/8/2014	8/25/2014 11:19	Satisfactorily Resolved
UT	Executive	Wendy Rasmussen Griggs	801-403-XXXX	Payment Issue	8/8/2014	8/27/2014 11:05	Satisfactorily Resolved

n/a	Friends and Family	William Persons	636-485-XXXX		Denies All Knowledge (DAK)	8/11/2014	8/18/2014 11:18	Satisfactorily Resolved
TX	Better Business Bureau	Zerick Whites	214-289-XXXX		Billing Issues	8/12/2014	8/28/2014 10:30	Satisfactorily Resolved
GA	Executive	Liz Mitchell	770-366-XXXX		Fees	8/13/2014	8/18/2014 10:34	Satisfactorily Resolved
TX	Friends and Family	George "Buck" Gorman	850-465-XXXX		Payment Issue	8/13/2014	8/27/2014 10:32	Satisfactorily Resolved
NV	Executive	Tim Deam	702-489-XXXX		Account Status	8/14/2014	8/28/2014 11:46	Satisfactorily Resolved
NV	Better Business Bureau	Janet Van Heck	702-489-XXXX		Refund Issue	8/19/2014	8/28/2014 10:32	Satisfactorily Resolved
IL	Better Business Bureau	Vince Aumann	312-415-XXXX		Account Set Up	8/20/2014	9/8/2014 15:04	Satisfactorily Resolved
TX	Better Business Bureau	Rebecca Rodriguez	817-820-XXXX		Billing Issues	8/20/2014	9/8/2014 15:07	Satisfactorily Resolved
KY	Better Business Bureau	Teresa Hoover	859-314-XXXX		Billing Issues	8/21/2014	9/9/2014 13:12	Satisfactorily Resolved
CO	Friends and Family	Jason Runyan	303-815-XXXX		Payment Issue	8/25/2014	9/9/2014 10:55	Satisfactorily Resolved
CO	Better Business Bureau	Jason Runyan	303-815-XXXX		Payment Issue	8/25/2014	9/9/2014 13:11	Satisfactorily Resolved
IL	Friends and Family	Demetrios Bracey	309-473-XXXX	Inmate	Payment Not Posted	8/25/2014	8/27/2014 15:42	Satisfactorily Resolved
IL	Friends and Family	Nicole Leiva	309-473-XXXX		Blocked/RCF	8/26/2014	8/27/2014 10:29	Satisfactorily Resolved
IL	Executive	Dallas Brockton	606-872-XXXX		Account Set Up	8/28/2014	9/5/2014 14:57	Satisfactorily Resolved
KY	Better Business Bureau	Lori Mayfield	606-872-XXXX		Other	9/1/2014	9/16/2014 9:01	Satisfactorily Resolved
n/a	Better Business Bureau	David Bayle	N/A		Refund Issue	9/3/2014	9/4/2014 9:18	Satisfactorily Resolved
FL	Friends and Family	Elizabeth Fumble	352-789-XXXX		Unwanted Dialer Calls	9/3/2014	9/5/2014 15:37	Satisfactorily Resolved
VA	Better Business Bureau	Dane Shifflett	540-989-XXXX		Refund Issue	9/5/2014	9/16/2014 8:34	Satisfactorily Resolved
FL	Executive	Ariana Bothwell	352-396-XXXX		Failure to escalate within CBS	9/5/2014	9/5/2014	Satisfactorily Resolved
IL	Friends and Family	Dorothy Skinner	478-982-XXXX		Fraud	9/8/2014	9/8/2014 13:44	Satisfactorily Resolved
AZ	Better Business Bureau	Irene Simmons	520-459-XXXX		Cut Off Calls (COC) - Cellular	9/9/2014	9/17/2014 9:48	Satisfactorily Resolved
FL	Better Business Bureau	Isaiah Jentes	954-306-XXXX		Payment Not Posted	9/9/2014	9/10/2014 8:58	Satisfactorily Resolved
OH	Friends and Family	Chevy McQuaid	614-863-XXXX		Refund Issue	9/9/2014	9/10/2014 13:17	Satisfactorily Resolved
TN	Better Business Bureau	Chelsea Wilcox	615-927-XXXX		Information Request	9/10/2014	9/24/2014 9:22	Satisfactorily Resolved
FL	Executive	Mark Fisher	352-343-XXXX		Unwanted Inmate Calls	9/10/2014	9/12/2014 15:32	Satisfactorily Resolved
IL	Friends and Family	Demetrios Whitney - Inmate	N/A		Payment Not Posted	9/16/2014	9/24/2014 15:42	Satisfactorily Resolved
OH	Executive	Jennifer Cannon	561-706-XXXX		Rude Rep	9/17/2014	9/18/2014 15:04	Satisfactorily Resolved
FL	Friends and Family	Paul Hunter	817-561-XXXX		Inability to Talk to Rep	9/18/2014	9/18/2014 14:32	Satisfactorily Resolved
AZ	Better Business Bureau	Dean Metzger	480-659-XXXX		Cut Off Calls (COC)	9/19/2014	9/25/2014 13:52	Satisfactorily Resolved
NM	Better Business Bureau	Rebecca Davis	505-358-XXXX		Cut Off Calls (COC) - Cellular	9/26/2014	10/6/2014 12:59	Satisfactorily Resolved
AL	Better Business Bureau	Stormy Williams Ravenhawk	334-300-XXXX		Cut Off Calls (COC) - Cellular	9/26/2014	10/6/2014 13:00	Satisfactorily Resolved
MIN	Friends and Family	Carolynne White	651-386-XXXX		Customer Not Getting Calls	9/26/2014	9/29/2014 12:55	Satisfactorily Resolved
TX	Better Business Bureau	Robert Hall	281-725-XXXX		Account Set Up	10/2/2014	10/15/2014 10:44	Satisfactorily Resolved
CO	Better Business Bureau	Jamie Crystal	503-349-XXXX		Payment Issue	10/2/2014	10/6/2014 12:42	Satisfactorily Resolved
KS	Better Business Bureau	Douglas Jensen	603-718-XXXX		Fees	10/2/2014	10/6/2014 10:33	Satisfactorily Resolved
CA	Better Business Bureau	Sarena Taylor	678-254-XXXX		Billing Issues	10/6/2014	10/10/2014 10:48	Satisfactorily Resolved
TX	Friends and Family	Adrienne Hank	304-991-XXXX		Customer Not Getting Calls	10/6/2014	10/10/2014 12:58	Satisfactorily Resolved
KS	Friends and Family	Bonnie Loring			Refund Issue	10/8/2014	10/24/2014 11:39	Satisfactorily Resolved
IL	Better Business Bureau	Jessica Criss	630-780-XXXX		180-Day Policy	10/9/2014	10/10/2014 11:06	Satisfactorily Resolved
CA	Better Business Bureau	Laura Winner	530-370-XXXX		Refund Issue	10/9/2014	10/16/2014 9:30	Satisfactorily Resolved
WI	Better Business Bureau	Nicole La Forge	920-548-XXXX		Billing Issues	10/9/2014	10/14/2014 9:51	Satisfactorily Resolved
WI	Better Business Bureau	Carolyn Beckwith	608-393-XXXX		Payment Not Posted	10/9/2014	10/24/2014 13:09	Satisfactorily Resolved
CT	Better Business Bureau	Brandy Lester	585-615-XXXX		Payment Issue	10/13/2014	10/24/2014 13:11	Satisfactorily Resolved
WI	Better Business Bureau	Luis Bonilla - Inmate	N/A		Payment Not Posted	10/13/2014	10/16/2014 9:31	Satisfactorily Resolved
IL	Executive	Edward Smith	Inmate		LEC Billing Changes	10/13/2014	10/15/2014 11:48	Satisfactorily Resolved
TX	Better Business Bureau	Jarice Bailey	303-426-XXXX		Payment Not Posted	10/13/2014	10/15/2014 10:32	Satisfactorily Resolved
WI	Friends and Family	Steve Miller	303-426-XXXX		Unwanted Inmate Calls	10/15/2014	10/22/2014 15:01	Satisfactorily Resolved
KS	Friends and Family	Tammy Dornick	316-204-XXXX		Other	10/15/2014	10/22/2014 15:01	Satisfactorily Resolved
MO	Better Business Bureau	Heather Aldridge	573-785-XXXX		180-Day Policy	10/15/2014	10/24/2014 13:13	Satisfactorily Resolved
WI	Better Business Bureau	Nichole Thompson	414-807-XXXX		Fees	10/15/2014	10/29/2014 16:30	Satisfactorily Resolved
GA	Better Business Bureau	Kenya Freeman	857-334-XXXX		Cut Off Calls (COC) - Cellular	10/21/2014	10/24/2014 13:14	Satisfactorily Resolved
OH	Better Business Bureau	Angelita Long Bytner	470-235-XXXX		Cut Off Calls (COC) - Cellular	10/21/2014	10/24/2014 13:14	Satisfactorily Resolved
TX	Better Business Bureau	Michelle Gaddis	216-541-XXXX		Payment Issue	10/21/2014	10/28/2014 15:12	Satisfactorily Resolved
IL	Better Business Bureau	Amie Ca'lock	309-963-XXXX		180-Day Policy	10/23/2014	10/31/2014 9:11	Satisfactorily Resolved
TX	Executive	Kenneth Pisto	979-201-XXXX		Refund Issue	10/27/2014	10/31/2014 14:43	Satisfactorily Resolved
IL	Better Business Bureau	Tiffany Thompson	630-486-XXXX		Account Set Up	10/28/2014	11/6/2014 16:58	Satisfactorily Resolved
TX	Better Business Bureau	Duce Serrano	512-428-XXXX		Billing Issues	10/28/2014	11/4/2014 9:47	Satisfactorily Resolved
WI	Better Business Bureau	David Rhodes	Inmate Complaint		Payment Not Posted	10/28/2014	10/31/2014 9:11	Satisfactorily Resolved
TX	Executive	Howard Smalowitz	512-894-XXXX		Other	10/28/2014	11/7/2014 11:10	Satisfactorily Resolved
CT	Executive	Mark Chicanos	Inmate Complaint		Payment Issue	10/30/2014	11/7/2014 11:05	Satisfactorily Resolved
FL	Executive	Berdine Chalmers	813-626-XXXX		Refund Issue	10/31/2014	11/6/2014 11:38	Satisfactorily Resolved
CA	Better Business Bureau	Linda Wilson Scott	925-339-XXXX		Refund Issue	11/5/2014	11/13/2014 9:22	Satisfactorily Resolved
CO	Executive	Kristi Tver	303-570-XXXX		Payment Issue	11/5/2014	11/11/2014 15:43	Satisfactorily Resolved

AZ	Executive	Teresa White	612-803-XXXX	Other	11/11/2014	11/14/2014 13:08	Satisfactorily Resolved
IL	Better Business Bureau	Elizabeth Leopold	815-236-XXXX	Payment Issue	11/12/2014	11/17/2014 11:47	Satisfactorily Resolved
CO	Executive	Patricia Ianello	818-365-XXXX	LEC Billing Changes	11/12/2014	11/21/2014 17:12	Satisfactorily Resolved
GA	Better Business Bureau	Kneisha Nelson	678-497-XXXX	Cut Off Calls (DOC) - Cellular	11/13/2014	11/17/2014 11:39	Satisfactorily Resolved
WA	Better Business Bureau	Beverly Bernards	425-222-XXXX	Refund Issue	11/13/2014	11/17/2014 11:44	Satisfactorily Resolved
TX	Executive	Rebecca Campoy	210-362-XXXX	Account Set Up	11/13/2014	11/14/2014 13:05	Satisfactorily Resolved
IL	Better Business Bureau	Priscilla Barragan	708-654-XXXX	Payment Issue	11/14/2014	11/18/2014 14:22	Satisfactorily Resolved
TX	Executive	Gregoria Delaon	806-257-XXXX	Customer Not Getting Calls	11/17/2014	11/21/2014 17:13	Satisfactorily Resolved
TX	Better Business Bureau	Matthew Stewart	912-222-XXXX	Refund Issue	11/19/2014	11/25/2014 15:10	Satisfactorily Resolved
IL	Better Business Bureau	Trineeta Heard	773-987-XXXX	Billing Issues	11/24/2014	12/2/2014 9:43	Satisfactorily Resolved
VA	Better Business Bureau	Holly Simmons	540-819-XXXX	Cut Off Calls (DOC) - Cellular	11/24/2014	12/10/2014 13:59	Satisfactorily Resolved
TX	Executive	Tawanna Hill	469-407-XXXX	Payment Issue	11/24/2014	11/25/2014 15:22	Satisfactorily Resolved
NC	Executive	Gonnie McCombs	704-279-XXXX	PrePaid Overages	11/26/2014	11/26/2014 15:55	Satisfactorily Resolved
TX	Better Business Bureau	Seville White	832-763-XXXX	Cut Off Calls (DOC) - Cellular	11/27/2014	12/8/2014 17:02	Satisfactorily Resolved
PA	Better Business Bureau	Nieves Wright	412-465-XXXX	Refund Issue	11/27/2014	12/8/2014 17:03	Satisfactorily Resolved
SC	Better Business Bureau	Dave Smith	803-767-XXXX	Other	12/3/2014	12/12/2014 10:58	Satisfactorily Resolved
FL	Better Business Bureau	Jeanne Crabree	813-571-XXXX	Refund Issue	12/4/2014	12/12/2014 11:09	Satisfactorily Resolved
IN	Better Business Bureau	Royce Ford	765-894-XXXX	Other	12/4/2014	12/12/2014 10:57	Satisfactorily Resolved
FL	Better Business Bureau	David Ricany	386-944-XXXX	PrePaid Overages	12/4/2014	12/16/2014 10:55	Satisfactorily Resolved
VA	Better Business Bureau	Brent Carmon	804-447-XXXX	Other	12/4/2014	12/12/2014 10:55	Satisfactorily Resolved
FL	Friends and Family	Timothy Bowdwy		Freud	12/4/2014	12/9/2014 12:18	Satisfactorily Resolved
TX	Better Business Bureau	Selina Zertuche	210-437-XXXX	Billing Issues	12/8/2014	12/16/2014 10:55	Satisfactorily Resolved
IL	Executive	Tony Bahrs	630-290-XXXX	Web Account Issue	12/8/2014	12/15/2014 15:27	Satisfactorily Resolved
NM	Executive	Blanca Lucero	505-695-XXXX	Unwanted Inmate Calls	12/8/2014	12/9/2014 12:27	Satisfactorily Resolved
VA	Better Business Bureau	Carolyn Cowherd	703-750-XXXX	Customer Not Getting Calls	12/9/2014	12/19/2014 17:15	Satisfactorily Resolved
KY	Executive	Cozetta Brown	513-851-XXXX	Freud	12/9/2014	12/12/2014 13:59	Satisfactorily Resolved
WI	Better Business Bureau	Patricia Chapman	773-582-XXXX	Payment Not Posted	12/10/2014	12/17/2014 12:06	Satisfactorily Resolved
LA	Better Business Bureau	Ms. Howard Jottis	931-823-XXXX	180-Day Policy	12/11/2014	12/19/2014 17:15	Satisfactorily Resolved
WI	Better Business Bureau	Luis Borrilla - Inmate		180-Day Policy	12/11/2014	12/17/2014 12:05	Satisfactorily Resolved
NC	Executive	Il American Bail Bonding - Souja Powe	910-231-XXXX	Payment Not Posted	12/11/2014	12/12/2014 14:06	Satisfactorily Resolved
WI	Better Business Bureau	Angier Jersett	816-399-XXXX	180-Day Policy	12/12/2014	12/19/2014 17:14	Satisfactorily Resolved
WI	Better Business Bureau	Nancy Creshinski	262-644-XXXX	LEC Billing Changes	12/16/2014	12/31/2014 9:05	Satisfactorily Resolved
AZ	Executive	Arnold Surtag	928-978-XXXX	Other	12/16/2014	1/5/2015 14:08	Satisfactorily Resolved
IL	Friends and Family	Alzhan Sanders	262-225-XXXX	Feet: Payment/Funding	12/19/2014	1/20/2015 16:29	Satisfactorily Resolved
KS	Friends and Family	Tammy Dornick	316-220-XXXX	Payment Issue	12/19/2014	1/20/2015 16:29	Satisfactorily Resolved
AZ	Better Business Bureau	Eula Thomas	623-206-XXXX	Payment Issue	12/22/2014	12/31/2014 9:03	Satisfactorily Resolved
NM	Better Business Bureau	Jovannah Sandovall	505-205-XXXX	Cut Off Calls (DOC) - Cellular	12/23/2014	1/6/2015 9:10	Satisfactorily Resolved
KS	Better Business Bureau	Kathleen Parikman	612-978-XXXX	SVV (Credit/Payment Issue)	12/23/2014	1/9/2015 10:06	Satisfactorily Resolved
KY	Better Business Bureau	Pritam Barr	813-420-XXXX	180-Day Policy	12/30/2014	1/6/2015 9:09	Satisfactorily Resolved
FL	Executive	Clayton Hill	352-870-XXXX	Billing Issues	12/30/2014	1/12/2015 9:40	Satisfactorily Resolved
MO	Executive	Steven Dyer	314-898-XXXX	Account Set Up	12/31/2014	1/12/2015 16:05	Satisfactorily Resolved
FL	Better Business Bureau	Jedia Haynes	850-728-XXXX	Cut Off Calls (DOC) - Cellular	1/2/2015	1/6/2015 9:08	Satisfactorily Resolved
PA	Better Business Bureau	Andre Venneire	412-339-XXXX	Refund Issue	1/2/2015	1/9/2015 9:11	Satisfactorily Resolved
FL	Better Business Bureau	Alise Alexander	786-262-XXXX	180-Day Policy	1/5/2015	1/7/2015 16:33	Satisfactorily Resolved
TX	Better Business Bureau	Carmen Burchfield	832-412-XXXX	PrePaid Overages	1/5/2015	1/7/2015 16:34	Satisfactorily Resolved
AZ	Executive	Mike Upshultz	520-363-XXXX	Inability to Talk to Rep	1/6/2015	1/7/2015 16:45	Satisfactorily Resolved
IL	Executive	Sandra Perry	815-672-XXXX	Customer Not Getting Calls	1/6/2015	1/12/2015 8:09	Satisfactorily Resolved
TX	Executive	John Roschal	903-915-XXXX	Account Set Up	1/6/2015	1/7/2015 16:46	Satisfactorily Resolved
PA	Executive	Shawn Bernier	724-332-XXXX	SVV (Credit/Payment Issue)	1/6/2015	1/7/2015 16:45	Satisfactorily Resolved
FL	Friends and Family	Amy Smith	850-419-XXXX	SVV (Credit/Payment Issue)	1/6/2015	1/26/2015 15:09	Satisfactorily Resolved
CT	Better Business Bureau	Shannon Cororan	860-985-XXXX	Payment Issue	1/7/2015	1/16/2015 9:01	Satisfactorily Resolved
MO	Better Business Bureau	Mark Hubbard		Customer Not Getting Calls	1/7/2015	1/16/2015 9:01	Satisfactorily Resolved
TX	Better Business Bureau	Elaina Nieves	210-573-XXXX	Account Status	1/7/2015	1/16/2015 9:02	Satisfactorily Resolved
MA	Better Business Bureau	Isiah Johnson	Ex Inmate	Cut Off Calls (DOC) - Cellular	1/7/2015	1/20/2015 10:03	Satisfactorily Resolved
KY	Friends and Family	Cheryl Kasze	606-571-XXXX	Refund Issue	1/7/2015	1/12/2015 12:55	Satisfactorily Resolved
IL	Better Business Bureau	Maria Lopez	773-567-XXXX	PrePaid Overages	1/8/2015	1/20/2015 10:03	Satisfactorily Resolved
TX	Better Business Bureau	Sonya Greer	281-229-XXXX	Payment Issue	1/8/2015	1/16/2015 9:02	Satisfactorily Resolved
IL	Executive	Michelle Gordon	708-200-XXXX	Rate Dispute	1/8/2015	1/8/2015 11:29	Satisfactorily Resolved
FL	Executive	Alicia Gillespie	239-537-XXXX	SVV (Credit/Payment Issue)	1/10/2015	1/20/2015 16:29	Satisfactorily Resolved
OR	Better Business Bureau	Alejandro Vasquez	503-255-XXXX	Freud	1/12/2015	1/20/2015 10:00	Satisfactorily Resolved
n/a	Better Business Bureau	Mary Walters	917-410-XXXX	Freud	1/13/2015	1/21/2015 13:42	Satisfactorily Resolved
n/a	Better Business Bureau	LaTasha Dunbar	254-258-XXXX	Account Set Up	1/13/2015	1/21/2015 13:42	Satisfactorily Resolved
CT	Better Business Bureau	James Hilton	N/A	Payment Not Posted	1/14/2015	1/21/2015 13:42	Satisfactorily Resolved

CT	Executive	Beatie Surratt	860-841-XXXX	1.80-Day Policy	1/15/2015	1/20/2015 16:29	Satisfactorily Resolved
FL	Better Business Bureau	Nancy Heath	352-861-XXXX	Cut Off Calls (DOC) - Cellular	1/16/2015	1/30/2015 12:44	Satisfactorily Resolved
TN	Better Business Bureau	Angela Bowman-Graham	423-313-XXXX	Cut Off Calls (DOC) - Cellular	1/16/2015	1/29/2015 9:54	Satisfactorily Resolved
OH	Executive	Katie Westrick	419-785-XXXX	Blocked/RFC	1/20/2015	4/11/2015 10:39	Satisfactorily Resolved
MO	Better Business Bureau	Teneasha Bennett	913-281-XXXX	Payment Processor's	1/21/2015	1/29/2015 9:53	Satisfactorily Resolved
WI	Better Business Bureau	Karen Hensler	920-756-XXXX	Refund Issue	1/21/2015	1/29/2015 9:53	Satisfactorily Resolved
VA	Better Business Bureau	Gloria Lynch	757-873-XXXX	Cut Off Calls (DOC) - Cellular	1/21/2015	1/29/2015 9:53	Satisfactorily Resolved
PA	Executive	John Legnine	Inmate	Information Request	1/21/2015	1/23/2015 15:59	Satisfactorily Resolved
TX	Executive	Joanne Jones	409-789-XXXX	SW (Credit/Payment Issue)	1/21/2015	4/11/2015 9:31	Satisfactorily Resolved
IL	Friends and Family	Warren Lowe	815-758-XXXX	1.80-Day Policy	1/21/2015	1/23/2015 15:59	Satisfactorily Resolved
FL	Executive	Jacqueline Shreffler	813-719-XXXX	Customer Not Getting Calls	1/22/2015	1/28/2015 15:32	Satisfactorily Resolved
TX	Executive	Lisa Longbottom	214-662-XXXX	Payment Another Company	1/22/2015	1/26/2015 15:09	Satisfactorily Resolved
AZ	Better Business Bureau	Anthony Burke	480-243-XXXX	Cut Off Calls (DOC) - Cellular	1/23/2015	2/4/2015 8:23	Satisfactorily Resolved
AZ	Better Business Bureau	Toni Echorn	928-323-XXXX	Blocked/RFC	1/23/2015	2/6/2015 8:24	Satisfactorily Resolved
MI	Executive	Nichole Austin	989-217-XXXX	Payment Another Company	1/23/2015	1/26/2015 15:09	Satisfactorily Resolved
TX	Executive	Tammy Sobolik	972-621-XXXX	Customer Not Getting Calls	1/26/2015	1/26/2015 15:09	Satisfactorily Resolved
TX	Executive	Cheryl Bryant	409-719-XXXX	Cut Off Calls (DOC) - Cellular	1/26/2015	1/27/2015 13:28	Satisfactorily Resolved
KY	Better Business Bureau	Amber Sonenson	502-418-XXXX	Cut Off Calls (DOC) - Cellular	1/27/2015	2/10/2015 10:30	Satisfactorily Resolved
PA	Executive	Donna Murray	727-822-XXXX	Call Quality	1/28/2015	2/2/2015 15:01	Satisfactorily Resolved
GA	Executive	Wanda Welcome	678-420-XXXX	Cut Off Calls (DOC) - Cellular	1/28/2015	1/28/2015 15:31	Satisfactorily Resolved
TX	Better Business Bureau	Alonzo Sandoval	760-774-XXXX	Billing Issues	1/29/2015	2/4/2015 8:23	Satisfactorily Resolved
LA	Executive	Nicole Battiste	212-461-XXXX	Payment Failures	1/29/2015	2/2/2015 15:01	Satisfactorily Resolved
NC	Better Business Bureau	Cindy Heavner Hill	704-232-XXXX	Payment Another Company	1/30/2015	2/12/2015 13:48	Satisfactorily Resolved
KY	Better Business Bureau	Allen Ewing	502-724-XXXX	Prepaid Overages	2/2/2015	2/10/2015 10:30	Satisfactorily Resolved
KY	Better Business Bureau	Shalonda Tinker	502-714-XXXX	Cut Off Calls (DOC) - Cellular	2/2/2015	2/19/2015 9:02	Satisfactorily Resolved
TX	Executive	Derrick Baller	Inmate	Information Request	2/2/2015	2/9/2015 9:35	Satisfactorily Resolved
KY	Better Business Bureau	Tanya Graby	859-913-XXXX	Cut Off Calls (DOC) - Cellular	2/4/2015	2/20/2015 9:46	Satisfactorily Resolved
TX	Better Business Bureau	Carol Weaver	972-243-XXXX	Billing Issues	2/4/2015	2/6/2015 8:25	Satisfactorily Resolved
WA	Better Business Bureau	Robin Ozuna	509-910-XXXX	Customer Not Getting Calls	2/4/2015	2/19/2015 12:59	Satisfactorily Resolved
WI	Better Business Bureau	Kathleen House	920-282-XXXX	Customer Not Getting Calls	2/4/2015	2/20/2015 9:46	Satisfactorily Resolved
MS	Better Business Bureau	Vicki Gary	228-806-XXXX	Customer Not Getting Calls	2/4/2015	2/19/2015 9:02	Satisfactorily Resolved
n/a	Better Business Bureau	Jack Sanderson	N/A	Billing Issues	2/5/2015	2/20/2015 9:47	Satisfactorily Resolved
SC	Better Business Bureau	Amber Jenkins	864-395-XXXX	Payment Processor's	2/5/2015	2/25/2015 8:42	Satisfactorily Resolved
CT	Better Business Bureau	Erin's Villalona	518-512-XXXX	Customer Not Getting Calls	2/6/2015	2/19/2015 9:02	Satisfactorily Resolved
LA	Better Business Bureau	Timothy Guidry	214-462-XXXX	Payment Not Posted	2/6/2015	2/19/2015 9:02	Satisfactorily Resolved
TX	Better Business Bureau	Chelsea Talley	214-462-XXXX	SW (Credit/Payment Issue)	2/6/2015	2/25/2015 8:43	Satisfactorily Resolved
FL	Executive	Amy Smith	850-419-XXXX	SV (Visit Issue)	2/6/2015	5/5/2015 10:09	Satisfactorily Resolved
OR	Better Business Bureau	Marla Dixon	503-995-XXXX	Fees: Payment/Funding;High Rates	2/9/2015	2/20/2015 10:21	Satisfactorily Resolved
n/a	Executive	Hazel Barris	980-320-XXXX	Freud	2/9/2015	3/4/2015 16:50	Satisfactorily Resolved
TX	Better Business Bureau	Debi L. Newton	979-595-XXXX	Cut Off Calls (DOC) - Cellular	2/10/2015	2/25/2015 8:42	Satisfactorily Resolved
TN	Better Business Bureau	Surette Marie Smith	504-388-XXXX	Account Set Up	2/10/2015	2/26/2015 9:28	Satisfactorily Resolved
MO	Better Business Bureau	James Clary	217-432-XXXX	Payment Not Posted	2/12/2015	2/19/2015 9:00	Satisfactorily Resolved
n/a	Better Business Bureau	Jessica Jennings	410-881-XXXX	Payment Chargebacks	2/12/2015	3/5/2015 9:21	Satisfactorily Resolved
TX	Better Business Bureau	Emily Puentes	361-343-XXXX	Payment Processor's	2/17/2015	3/5/2015 9:21	Satisfactorily Resolved
GA	Better Business Bureau	Marcos Sanchez	229-317-XXXX	Refund Issue	2/17/2015	2/20/2015 11:41	Satisfactorily Resolved
n/a	Executive	Curtis Green	469-964-XXXX	Account/Billing Conversion	2/17/2015	3/9/2015 8:23	Satisfactorily Resolved
TX	Friends and Family	Brian Kirkham	806-383-XXXX	Payment Processing Time	2/17/2015	4/6/2015 10:05	Satisfactorily Resolved
WI	Better Business Bureau	Sabina Kostic	319-820-XXXX	Payment Chargebacks	2/20/2015	3/5/2015 9:21	Satisfactorily Resolved
WA	Friends and Family	David Baker	353-840-XXXX	Freud	2/20/2015	2/20/2015 14:17	Satisfactorily Resolved
FL	Better Business Bureau	Amy Brown	786-419-XXXX	Cut Off Calls (DOC) - Cellular	2/23/2015	3/12/2015 8:57	Satisfactorily Resolved
TX	Better Business Bureau	Stefan Duibel	360-419-XXXX	SW (Credit/Payment Issue)	2/23/2015	3/11/2015 10:20	Satisfactorily Resolved
FL	Executive	Edna Lucas	904-415-XXXX	Prepaid Overages	2/24/2015	3/4/2015 16:50	Satisfactorily Resolved
KS	Executive	R. H. Rogers	316-522-XXXX	Cut Off Calls (DOC)	2/24/2015	3/4/2015 16:50	Satisfactorily Resolved
LA	Better Business Bureau	Karis Cleveland	225-975-XXXX	Account Set Up	3/3/2015	3/18/2015 15:34	Satisfactorily Resolved
TX	Better Business Bureau	Doris James	325-676-XXXX	1.80-Day Policy	3/3/2015	3/11/2015 10:19	Satisfactorily Resolved
CO	Better Business Bureau	Sandra Dilla	970-590-XXXX	Fees	3/3/2015	3/11/2015 10:20	Satisfactorily Resolved
KS	Better Business Bureau	Mariah Foley	316-371-XXXX	SW (Credit/Payment Issue)	3/5/2015	3/17/2015 15:06	Satisfactorily Resolved
CO	Better Business Bureau	Jennifer Brennan	847-489-XXXX	No Positive Acceptance	3/5/2015	3/17/2015 14:48	Satisfactorily Resolved
PA	Executive	Guy Beaver	570-643-XXXX	Web/Account Issue	3/6/2015	3/26/2015 16:36	Satisfactorily Resolved
WA	Better Business Bureau	John Lujan	253-906-XXXX	Prepaid Overages	3/9/2015	3/19/2015 8:51	Satisfactorily Resolved
n/a	Better Business Bureau	Jennifer Turney	334-221-XXXX	Freud	3/10/2015	3/25/2015 14:00	Satisfactorily Resolved
WI	Better Business Bureau	Tana Teismann	414-840-XXXX	Denies All Knowledge (DAK)	3/10/2015	3/27/2015 9:22	Satisfactorily Resolved
n/a	Executive	Jennifer	972-743-XXXX	Unwanted Dialer Calls	3/11/2015	4/7/2015 14:45	Satisfactorily Resolved

MN	Better Business Bureau	Manisha Roberts	651-373-XXXX	Cut Off Calls (COQ)	3/12/2015	3/27/2015 13:47	Satisfactorily Resolved
IL	Better Business Bureau	Marlene Presswood	773-226-XXXX	Cut Off Calls (COQ)	3/16/2015	3/27/2015 9:40	Satisfactorily Resolved
n/a	Executive	Leonard Wachtnak	414-524-XXXX	Unwanted Inmate Calls	3/17/2015	4/7/2015 14:42	Satisfactorily Resolved
AZ	Better Business Bureau	Courtney Fisher	760-969-XXXX	Non Refundable SVV visits	3/18/2015	3/30/2015 10:03	Satisfactorily Resolved
n/a	Better Business Bureau	Janice Morgan	505-382-XXXX	Unwanted Inmate Calls	3/18/2015	3/26/2015 9:07	Satisfactorily Resolved
TX	Better Business Bureau	Tamara Anderson	979-549-XXXX	Information Request	3/18/2015	3/20/2015 7:39	Satisfactorily Resolved
WI	Better Business Bureau	Allison Peot	608-206-XXXX	Payment Chargebacks	3/18/2015	3/27/2015 9:57	Satisfactorily Resolved
WI	Better Business Bureau	Timothy Wehrlein	262-408-XXXX	180 Day Inactivity Policy	3/18/2015	3/27/2015 9:46	Satisfactorily Resolved
IL	Executive	Charles Heisinger	847-332-XXXX	Non Refundable SVV visits	3/18/2015	4/10/2015 16:23	Satisfactorily Resolved
MI	Better Business Bureau	Jennifer Ostwald	989-370-XXXX	Cut Off Calls (COQ)	3/20/2015	4/16/2015 11:16	Satisfactorily Resolved
MN	Executive	Peggy M. Ketch	N/A	CPNI	3/30/2015	4/8/2015 7:35	Satisfactorily Resolved
AZ	Executive	Elaire Fogel	602-358-XXXX	No Positive Acceptance	3/31/2015	4/27/2015 13:55	Satisfactorily Resolved
n/a	Friends and Family	Larry Lancaster	270-781-XXXX	Fraud (Credit Card/Identity)	3/31/2015	4/28/2015 12:27	Satisfactorily Resolved
WI	Better Business Bureau	Sou Her	N/A	Refund Issue	4/1/2015	4/16/2015 11:06	Satisfactorily Resolved
FL	Executive	Ervin Horton	Inmate	LEC Billing Conversion	4/3/2015	4/23/2015 10:00	Satisfactorily Resolved
TX	Better Business Bureau	Kent Ohler	713-502-XXXX	Denies All Knowledge (DAK)	4/7/2015	4/19/2015 9:16	Satisfactorily Resolved
KY	Executive	Shabnam Vafaei	818-606-XXXX	Unwanted Dialer Calls	4/8/2015	4/23/2015 14:12	Satisfactorily Resolved
IL	Better Business Bureau	Eleanor Field	832-641-XXXX	180 Day Inactivity Policy	4/9/2015	4/10/2015 9:24	Satisfactorily Resolved
TX	Better Business Bureau	Dunia Ramos	832-746-XXXX	Payment Not Posted	4/9/2015	4/17/2015 10:08	Satisfactorily Resolved
TX	Executive	Joanna Jones	409-789-XXXX	SVV	4/11/2015	4/11/2015 10:39	Satisfactorily Resolved
FL	Executive	Charles Woods	850-674-XXXX	High Rates	4/11/2015	4/17/2015 7:01	Satisfactorily Resolved
AZ	Better Business Bureau	George Nolan	602-551-XXXX	Refund Issue	4/13/2015	4/21/2015 10:01	Satisfactorily Resolved
AZ	Better Business Bureau	Denise Craft	714-271-XXXX	Fees: Wireless/Admin/Regulatory	4/13/2015	4/17/2015 15:45	Satisfactorily Resolved
n/a	Better Business Bureau	Noreen Lancaster	404-362-XXXX	Account Set Up	4/13/2015	4/23/2015 9:31	Satisfactorily Resolved
TX	Better Business Bureau	Suzana Naranjo-Jara millo	361-774-XXXX	Billing Dispute	4/13/2015	4/23/2015 9:31	Satisfactorily Resolved
UT	Better Business Bureau	Mary Jensen	801-652-XXXX	Cut Off Calls (COQ)	4/13/2015	4/17/2015 10:41	Satisfactorily Resolved
AZ	Better Business Bureau	Taya Compton	480-784-XXXX	SVV	4/14/2015	4/27/2015 11:48	Satisfactorily Resolved
KS	Better Business Bureau	Maria Rivas	316-260-XXXX	SVV	4/14/2015	4/29/2015 11:56	Satisfactorily Resolved
TX	Executive	Tonya Alexander	469-877-XXXX	Payment Issues	4/14/2015	4/16/2015 15:24	Satisfactorily Resolved
TX	Executive	stina Clay on behalf of Sherry Ander	702-463-XXXX	Refund Process	4/15/2015	4/19/2015 17:51	Satisfactorily Resolved
IL	Better Business Bureau	Natalie Robinson	773-450-XXXX	No Positive Acceptance	4/16/2015	4/28/2015 9:24	Satisfactorily Resolved
n/a	Better Business Bureau	Casey Baldwin	N/A	Fees: Payment/Funding	4/16/2015	4/23/2015 9:30	Satisfactorily Resolved
GA	Better Business Bureau	Latonya Gresham	678-353-XXXX	Cut Off Calls (COQ)	4/17/2015	5/8/2015 10:43	Satisfactorily Resolved
TX	Better Business Bureau	Monica Olivia	706-372-XXXX	SVV	4/17/2015	4/29/2015 11:58	Satisfactorily Resolved
GA	Better Business Bureau	Janet Smith	239-324-XXXX	Payment Fee Credits	4/17/2015	4/27/2015 11:48	Satisfactorily Resolved
IA	Better Business Bureau	Melissa Charco	712-293-XXXX	Fees: Wireless/Admin/Regulatory	4/17/2015	4/28/2015 9:26	Satisfactorily Resolved
KS	Better Business Bureau	Tim Trent	816-693-XXXX	SVV	4/17/2015	4/29/2015 11:57	Satisfactorily Resolved
TX	Executive	ristina Clay on behalf of Juanita Okpu	214-962-XXXX	Rude Rep	4/17/2015	4/19/2015 17:50	Satisfactorily Resolved
IL	Better Business Bureau	Elizabeth Tyler	773-633-XXXX	180 Day Inactivity Policy	4/21/2015	5/6/2015 9:53	Satisfactorily Resolved
NM	Better Business Bureau	Ronnie King	Inmate	Cut Off Calls (COQ)	4/22/2015	5/11/2015 16:19	Satisfactorily Resolved
WI	Better Business Bureau	Cory Ellis	Inmate	Payment Not Posted	4/22/2015	4/29/2015 11:59	Satisfactorily Resolved
FL	Better Business Bureau	Karen Roberts	386-473-XXXX	Account/Billing Conversion	4/23/2015	5/11/2015 14:46	Satisfactorily Resolved
n/a	Better Business Bureau	Wendy Ahlstrom	704-774-XXXX	Unwanted Inmate Calls	4/23/2015	5/1/2015 16:29	Satisfactorily Resolved
AZ	Better Business Bureau	Tammy Zellner	414-238-XXXX	SVV (Wait Issue)	4/27/2015	5/6/2015 14:20	Satisfactorily Resolved
CA	Better Business Bureau	Michala Davis	510-940-XXXX	Cut Off Calls (COQ)	4/27/2015	5/6/2015 14:44	Satisfactorily Resolved
NM	Better Business Bureau	Irene Symbola-Shije	505-247-XXXX	Refund Issue	4/28/2015	5/11/2015 16:46	Satisfactorily Resolved
NC	Better Business Bureau	Merion Jewett	704-381-XXXX	Billing Issues	4/28/2015	5/14/2015 13:59	Satisfactorily Resolved
KY	Better Business Bureau	Scilly Morris	502-802-XXXX	Cut Off Calls (COQ)	4/28/2015	5/14/2015 14:27	Satisfactorily Resolved
CT	Friends and Family	Michael Zukowski	Inmate	CPNI	4/28/2015	5/4/2015 11:22	Satisfactorily Resolved
SC	Friends and Family	Sarah Bonaparte	843-486-XXXX	Fees: Wireless/Admin/Regulatory	4/28/2015	5/4/2015 11:28	Satisfactorily Resolved
WI	Better Business Bureau	Susan Jean Renkens	920-202-XXXX	Refund Issue	4/30/2015	5/18/2015 16:18	Satisfactorily Resolved
MO	Friends and Family	Gregory King	660-815-XXXX	Unwanted Inmate Calls	4/30/2015	5/28/2015 16:15	Satisfactorily Resolved
AZ	Better Business Bureau	Christina Harrison	602-575-XXXX	SVV (Wait Issue)	5/1/2015	5/22/2015 10:50	Satisfactorily Resolved
FL	Better Business Bureau	Nicole Mozell	352-390-XXXX	Cut Off Calls (COQ)	5/1/2015	5/19/2015 15:34	Satisfactorily Resolved
IL	Better Business Bureau	Jerome Johnson	Inmate	Payment Not Posted	5/1/2015	5/1/2015 11:20	Satisfactorily Resolved
FL	Executive	Patricia Wiggins	561-667-XXXX	Duplicate Account Merged	5/1/2015	5/28/2015 14:23	Satisfactorily Resolved
CA	Better Business Bureau	Shirley McGill	619-423-XXXX	Cut Off Calls (COQ)	5/4/2015	5/19/2015 16:03	Satisfactorily Resolved
MA	Better Business Bureau	Sheree Hoose	978-394-XXXX	Cut Off Calls (COQ)	5/4/2015	5/21/2015 16:22	Satisfactorily Resolved
IL	Better Business Bureau	Jessie Ingram	773-412-XXXX	90 Day Inactivity Policy	5/5/2015	5/28/2015 11:29	Satisfactorily Resolved
IL	Better Business Bureau	Ronald Burrows	347-696-XXXX	No Positive Acceptance	5/5/2015	5/22/2015 13:05	Satisfactorily Resolved
TX	Better Business Bureau	Shafrine Law	979-313-XXXX	Payment Issues	5/5/2015	6/2/2015 14:24	Satisfactorily Resolved
TX	Better Business Bureau	Yarmin Strickland	832-646-XXXX	Payment Issues	5/6/2015	6/2/2015 16:56	Satisfactorily Resolved
TX	Better Business Bureau	Percy Grant	214-859-XXXX	Refund Issue	5/6/2015	6/2/2015 17:05	Satisfactorily Resolved

VA	Better Business Bureau Executive	Tia Sellers	410-916-XXXX	Tablet Issues CPNI	5/6/2015	5/19/2015 14:28	Satisfactorily Resolved
IL	Better Business Bureau	Amy Kulac	630-549-XXXX		5/8/2015	5/14/2015 13:05	Satisfactorily Resolved
CT	Better Business Bureau	Ullysa Campbell	203-345-XXXX	Failure to escalate within CBS #No Positive Acceptance	5/12/2015	6/2/2015 12:47	Satisfactorily Resolved
FL	Better Business Bureau	Stacey Lynn Collins	419-989-XXXX	180 Day Inactivity Policy	5/12/2015	6/2/2015 12:25	Satisfactorily Resolved
OH	Friends and Family	Rita Battaglia	646-477-XXXX	Denies All Knowledge (DAK)	5/12/2015	6/9/2015 15:58	Satisfactorily Resolved
FL	Better Business Bureau	Charles Born	850-217-XXXX	Unwanted Inmate Calls	5/14/2015	5/28/2015 16:04	Satisfactorily Resolved
AR	Better Business Bureau	Elizabeth Wald Barnes	479-567-XXXX	Rude Rep	5/14/2015	5/22/2015 14:01	Satisfactorily Resolved
MS	Executive	Al Williams Ball Bond Co	662-429-XXXX	Payment Issues	5/14/2015	6/4/2015 12:21	Satisfactorily Resolved
LA	Friends and Family	Matina Abney	318-491-XXXX	Call Quality #High Rates	5/14/2015	6/9/2015 16:14	Satisfactorily Resolved
TX	Better Business Bureau	Jason Ayala	281-253-XXXX	CBS Giving Wrong Information	5/15/2015	6/2/2015 12:38	Satisfactorily Resolved
SC	Executive	Metro Bonding	828-776-XXXX	Payment Issues	5/15/2015	6/4/2015 17:08	Satisfactorily Resolved
MI	Better Business Bureau	Verzier Stewart	313-989-XXXX	Inability to Talk to Rep - Hold Time #Payment Not Posted	5/18/2015	6/9/2015 15:12	Satisfactorily Resolved
IL	Better Business Bureau	Carlos Ayala	N/A	Billing Issues	5/20/2015	6/12/2015 17:29	Satisfactorily Resolved
VA	Better Business Bureau	Debra Hudgins	757-570-XXXX	Secure Instant Mail (SIM)#SVV (Visit Issue)	5/20/2015	6/10/2015 12:05	Satisfactorily Resolved
IL	Executive	Rose Marie Ackerman	217-528-XXXX	No Positive Acceptance	5/20/2015	6/5/2015 12:34	Satisfactorily Resolved
OH	Better Business Bureau	Dawn Ellis	419-787-XXXX	CBS Giving Wrong Information	5/21/2015	6/5/2015 13:27	Satisfactorily Resolved
AL	Better Business Bureau	Allison Adams	334-569-XXXX	Refund Issue	5/21/2015	6/12/2015 17:37	Satisfactorily Resolved
TX	Executive	De Esta Wiley	817-683-XXXX	Denies All Knowledge (DAK)#Failure to escalate within CBS#Supervisor Failed to Return Phone Call	5/21/2015	6/4/2015 12:44	Satisfactorily Resolved
PA	Executive	Maryellen Moreyra	610-628-XXXX	Failure to escalate within CBS#Remote Call Forwarding/Call Diversion#Rude Rep	5/23/2015	6/9/2015 17:16	Satisfactorily Resolved
PA	Better Business Bureau	Maryellen Moreyra	610-628-XXXX	Remote Call Forwarding/Call Diversion#Holds Rep	5/25/2015	6/10/2015 14:08	Satisfactorily Resolved
FL	Better Business Bureau	James locklear	904-476-XXXX	Cut Off Calls (COQ)#Rude Rep#Supervisor Failed to Return Phone Call	5/27/2015	6/2/2015 12:30	Satisfactorily Resolved
KY	Better Business Bureau	David Mele	412-860-XXXX	Failure to escalate within CBS#Inability to Talk to Rep - Hold Time#Inability to Talk to Rep (IVR)	5/27/2015	6/12/2015 17:36	Satisfactorily Resolved
MN	Executive	Soledad Brown	715-220-XXXX	Remote Call Forwarding/Call Diversion	5/27/2015	6/9/2015 16:37	Satisfactorily Resolved
TX	Better Business Bureau	Guadalupe Arredondo	832-771-XXXX	Cut Off Calls (COQ)	5/28/2015	5/29/2015 15:55	Satisfactorily Resolved
n/A	Better Business Bureau	Nicole Lambert	N/A	Securus Outage	6/2/2015	6/16/2015 17:04	Satisfactorily Resolved
TX	Better Business Bureau	Nancy Rablede	512-792-XXXX	Securus Outage	6/2/2015	6/16/2015 17:07	Satisfactorily Resolved
MI	Better Business Bureau	Kyle Maguire	714-206-XXXX	CBS Giving Wrong Information#Payment Issues	6/2/2015	6/17/2015 10:54	Satisfactorily Resolved
KY	Executive	Mary Maddox	214-549-XXXX	Information Request#Remote Call Forwarding/Call Diversion	6/2/2015	6/11/2015 13:00	Satisfactorily Resolved
TX	Better Business Bureau	Ron Fladmark	829-200-XXXX	Inability to Talk to Rep (IVR)#Payment Issues	6/8/2015	6/17/2015 10:52	Satisfactorily Resolved
OH	Better Business Bureau	Suzanne Terrant	614-203-XXXX	Inability to Talk to Rep - Hold Time #Payment Issues	6/8/2015	6/17/2015 17:09	Satisfactorily Resolved
TX	Better Business Bureau	Danile Krzeczowski	973-803-XXXX	CBS Giving Wrong Information#Rate Dispute	6/9/2015	6/19/2015 15:42	Satisfactorily Resolved
NY	Better Business Bureau	Jessica Cokely	814-380-XXXX	CBS Giving Wrong Information#Inability to Talk to Rep - Hold Time#Remote Call Forwarding/Call Diversion	6/9/2015	6/19/2015 12:31	Satisfactorily Resolved
AZ	Better Business Bureau	Theresa Elliott	928-580-XXXX	Billing Issues	6/11/2015	6/22/2015 17:13	Satisfactorily Resolved
CT	Better Business Bureau	Quamell Spearman (Nichols#Frabier)	203-526-XXXX	Payment Not Posted	6/11/2015	6/25/2015 17:09	Satisfactorily Resolved
Mh	Better Business Bureau	Derrick Johnson	414-522-XXXX	Cut Off Calls (COQ)	6/11/2015	7/2/2015 8:31	Satisfactorily Resolved
MN	Better Business Bureau	Kyle Schanz	612-419-XXXX	CBS Giving Wrong Information#Inability to Talk to Rep - Hold Time #SVV (Visit Issue)	6/11/2015	6/19/2015 17:29	Satisfactorily Resolved
IL	Better Business Bureau	Robert Salseda	Inmate Complaint	90 Day Inactivity Policy#Inability to Talk to Rep (IVR)	6/15/2015	6/19/2015 17:09	Satisfactorily Resolved
IL	Better Business Bureau	William Cavico	630-234-XXXX	Account Set Up#Inability to Talk to Rep - Hold Time	6/16/2015	6/25/2015 12:55	Satisfactorily Resolved
IL	Better Business Bureau	Michelle Wilhite	815-263-XXXX	Cut Off Calls (COQ)#Inability to Talk to Rep - Hold Time	6/17/2015	6/30/2015 7:49	Satisfactorily Resolved
KY	Better Business Bureau	Patrick Lochirco	502-589-XXXX	CPNI#Inability to Talk to Rep (IVR)	6/19/2015	7/1/2015 11:24	Satisfactorily Resolved
MI	Executive	Venesa Housley	419-788-XXXX	Cut Off Calls (COQ)	6/22/2015	6/25/2015 18:00	Satisfactorily Resolved
IL	Better Business Bureau	Juanita DeJesus	773-698-XXXX	180-Day Policy	6/23/2015	7/2/2015 9:44	Satisfactorily Resolved
IL	Better Business Bureau	Darcie Navarro	630-341-XXXX	Cut Off Calls (COQ)#Inability to Talk to Rep - Hold Time	6/23/2015	7/2/2015 15:27	Satisfactorily Resolved
CO	Better Business Bureau	Katherin Knight	970-201-XXXX	Cut Off Calls (COQ)	6/23/2015	7/2/2015 15:31	Satisfactorily Resolved
FL	Better Business Bureau	LaShauna Benis	352-871-XXXX	Failure to escalate within CBS#Inability to Talk to Rep - Hold Time#Payment Not Posted	6/25/2015	7/6/2015 10:07	Satisfactorily Resolved
IL	Better Business Bureau	Rebecca Weems	217-726-XXXX	Cut Off Calls (COQ)#Inability to Talk to Rep - Hold Time	6/25/2015	7/2/2015 15:33	Satisfactorily Resolved
CO	Better Business Bureau	Jerry Zimmer	720-261-XXXX	Unwanted Inmate Calls	6/25/2015	6/30/2015 8:08	Satisfactorily Resolved
IL	Better Business Bureau	Karen McCoy	312-460-XXXX	Cut Off Calls (COQ)	6/30/2015	7/10/2015 17:31	Satisfactorily Resolved
NC	Better Business Bureau	Donna Horner	336-221-XXXX	Inability to Talk to Rep - Hold Time #Payment Issues	6/30/2015	7/8/2015 15:49	Satisfactorily Resolved

AZ	Better Business Bureau Executive	Jason McConnell	602-320-XXXX	Refund Issue	7/1/2015	7/8/2015	7/8/2015 16:11	Satisfactorily Resolved
PA	Better Business Bureau Executive	Monica Brown	910-989-XXXX	Fraud (Credit Card/Identity)	7/2/2015	7/2/2015	7/16/2015 13:20	Satisfactorily Resolved
IL	Better Business Bureau	Margaret Buzau	630-725-XXXX	CBS Giving Wrong Information#Fees: Payment/Funding	7/3/2015	7/3/2015	7/14/2015 17:00	Satisfactorily Resolved
TX	Better Business Bureau	Fay Windsor	806-240-XXXX	Cut Off Calls (COQ)#Hate Dispute	7/3/2015	7/3/2015	7/13/2015 13:50	Satisfactorily Resolved
MN	Better Business Bureau	Vonda Vaden Bates	612-247-XXXX	CBS Giving Wrong Information#SVV (Visit Issue)	7/3/2015	7/3/2015	7/15/2015 16:24	Satisfactorily Resolved
PA	Better Business Bureau	Kristy Bonebrake	717-331-XXXX	CBS Giving Wrong Information#Failure to escalate within CBS#No Positive Acceptance	7/8/2015	7/8/2015	7/23/2015 9:31	Satisfactorily Resolved
SC	Better Business Bureau	Robin Lynn Achor	843-424-XXXX	CBS Giving Wrong Information#Refund Issue	7/8/2015	7/8/2015	7/17/2015 8:54	Satisfactorily Resolved
TX	Better Business Bureau Executive	Daneshia Nelson	713-886-XXXX	CBS Giving Wrong Information#Cut Off Calls (COQ)#Inability to Talk to Rep - Hold Time	7/14/2015	7/14/2015	7/27/2015 10:46	Satisfactorily Resolved
AR	Better Business Bureau Executive	Rudolph Shokal	208-837-XXXX	Cut Off Calls (COQ)#Inability to Talk to Rep (WR)	7/14/2015	7/14/2015	7/21/2015 12:47	Satisfactorily Resolved
IL	Better Business Bureau Executive	Claude McGee	951-315-XXXX	Cut Off Calls (COQ)#High Rates#Payment Not Posted	7/14/2015	7/14/2015	7/30/2015 23:11	Satisfactorily Resolved
CA	Better Business Bureau Executive	Leslie Miller	951-315-XXXX	Fraud (Credit Card/Identity)	7/15/2015	7/15/2015	7/22/2015 12:44	Satisfactorily Resolved
FL	Better Business Bureau Executive	Bob Pollack	951-314-XXXX	Cut Off Calls (COQ)#Hate Rep	7/15/2015	7/15/2015	7/21/2015 12:48	Satisfactorily Resolved
IL	Better Business Bureau Friends and Family	Toni Shumate	708-724-XXXX	CBS Giving Wrong Information#Customer Not Getting Calls#Failure to escalate within CBS	7/20/2015	7/20/2015	7/30/2015 22:50	Satisfactorily Resolved
FL	Better Business Bureau Friends and Family	Carolyn Marshall	415-407-XXXX	Customer Not Getting Calls	7/20/2015	7/20/2015	7/22/2015 11:27	Satisfactorily Resolved
TX	Better Business Bureau	Kristen Tanning	214-298-XXXX	Billing Issues#Inability to Talk to Rep - Hold Time	7/21/2015	7/21/2015	8/4/2015 8:03	Satisfactorily Resolved
IN	Better Business Bureau	Marsha Charney	317-672-XXXX	Cut Off Calls (COQ)	7/21/2015	7/21/2015	8/4/2015 8:24	Satisfactorily Resolved
KS	Better Business Bureau	Thelma Camar	832-209-XXXX	Inability to Talk to Rep - Hold Time#SVV (Visit Issue)	7/21/2015	7/21/2015	8/4/2015 21:58	Satisfactorily Resolved
AZ	Better Business Bureau	Dardanel Robinson	503-219-XXXX	Inability to Talk to Rep - Hold Time#Refund Issue	7/22/2015	7/22/2015	8/4/2015 9:08	Satisfactorily Resolved
AZ	Better Business Bureau	Kaisha Klinder	928-606-XXXX	380-Day Policy#Payment Issues	7/23/2015	7/23/2015	8/6/2015 15:52	Satisfactorily Resolved
TX	Better Business Bureau	Jana Haverd Smith	512-965-XXXX	Cut Off Calls (COQ)#Inability to Talk to Rep - Hold Time	7/24/2015	7/24/2015	8/10/2015 9:46	Satisfactorily Resolved
GA	Better Business Bureau	Diane Hartman	801-368-XXXX	SVV	7/28/2015	8/10/2015	8/10/2015 8:03	Satisfactorily Resolved
KY	Better Business Bureau Executive	Rudolph Shokal	650-576-XXXX	Customer Not Getting Calls	7/28/2015	7/30/2015	7/30/2015 15:30	Satisfactorily Resolved
IL	Better Business Bureau	Keith Thompson	920-257-XXXX	Unwanted Inmate Calls#Unwanted Dialer Calls	7/29/2015	8/10/2015	9:58	Satisfactorily Resolved
SC	Better Business Bureau	Scott Myers	978-614-XXXX	Inability to Talk to Rep (WR)#Payment Issues#SVV (Visit Issue)	7/29/2015	7/29/2015	8/4/2015 21:55	Satisfactorily Resolved
AZ	Better Business Bureau	Lacy Leppard	904-599-XXXX	Billing Issues#Failure to escalate within CBS	7/29/2015	8/6/2015	16:28	Satisfactorily Resolved
IL	Better Business Bureau	Kimberly Johnson	773-679-XXXX	Cut Off Calls (COQ)	8/1/2015	8/21/2015	15:50	Satisfactorily Resolved
TX	Better Business Bureau	Kayla Miranda	210-213-XXXX	Account/Billing Conversion	8/3/2015	8/7/2015	17:23	Satisfactorily Resolved
WI	Better Business Bureau	Christine Manning-Bartz	920-676-XXXX	Payment Another Company#Remote Call Forwarding/Call Diversion	8/6/2015	8/10/2015	9:35	Satisfactorily Resolved
OH	Better Business Bureau	Kelly Hill	937-559-XXXX	Cut Off Calls (COQ)#High Rates	8/6/2015	8/13/2015	9:19	Satisfactorily Resolved
TX	Better Business Bureau	Kathy Ferrari	559-227-XXXX	Cut Off Calls (COQ)#Inability to Talk to Rep#Payment Another Company	8/7/2015	8/14/2015	10:12	Satisfactorily Resolved
GA	Better Business Bureau	Charmsina Norman	404-200-XXXX	SVV (Visit Issue)	8/12/2015	8/19/2015	11:46	Satisfactorily Resolved
AR	Better Business Bureau	Victoria Hamilton	903-948-XXXX	Call Quality#High Rates	8/17/2015	9/16/2015	15:27	Satisfactorily Resolved
TX	Better Business Bureau Friends and Family	Daneshia Nelson	713-886-XXXX	Cut Off Calls (COQ)	8/17/2015	8/18/2015	15:13	Satisfactorily Resolved
M	Better Business Bureau	Megan Davison	734-664-XXXX	Cut Off Calls (COQ)#Fees: Payment/Funding#High Rates	8/21/2015	9/2/2015	8:33	Satisfactorily Resolved
VA	Better Business Bureau	Willie Smith	Inmate Compliant	High Rates#Inability to Talk to Rep - Hold Time	8/21/2015	8/26/2015	15:40	Satisfactorily Resolved
MO	Better Business Bureau	James Lihart	815-601-XXXX	Fraud (Credit Card/Identity)#Inability to Talk to Rep (WR)	8/25/2015	9/3/2015	13:07	Satisfactorily Resolved
WY	Better Business Bureau	Bert Pezarosi	406-551-XXXX	Fees: Wireless/Adm/Regulatory	8/25/2015	9/1/2015	14:49	Satisfactorily Resolved
M	Better Business Bureau	Mike Pease	616-304-XXXX	High Rates	8/25/2015	9/3/2015	13:15	Satisfactorily Resolved
FL	Better Business Bureau	Ed Huffman	850-862-XXXX	Cut Off Calls (COQ)	8/27/2015	9/1/2015	15:10	Satisfactorily Resolved
GA	Better Business Bureau	Carol Harris	678-395-XXXX	CBS Giving Wrong Information#Payment Issues	8/27/2015	9/1/2015	15:31	Satisfactorily Resolved
TX	Better Business Bureau Friends and Family	Daneshia Nelson	713-886-XXXX	Cut Off Calls (COQ)	8/27/2015	9/1/2015	14:25	Satisfactorily Resolved
OH	Better Business Bureau Friends and Family	Kelly Hill	937-559-XXXX	Cut Off Calls (COQ)	8/27/2015	8/31/2015	8:12	Satisfactorily Resolved
TX	Better Business Bureau	Brenda Bonner	903-389-XXXX	Fraud (Credit Card/Identity)	9/1/2015	9/16/2015	16:10	Satisfactorily Resolved
AZ	Better Business Bureau	Fay Collier	623-984-XXXX	Inability to Talk to Rep - Hold Time#Refund Check Delivery Times	9/2/2015	9/11/2015	10:30	Satisfactorily Resolved
TX	Better Business Bureau	Geraldine Stowers	409-838-XXXX	Billing Issues	9/2/2015	9/16/2015	12:36	Satisfactorily Resolved
OH	Better Business Bureau Friends and Family	Kelly Hill	937-559-XXXX	Cut Off Calls (COQ)	9/9/2015	9/16/2015	10:11	Satisfactorily Resolved
MO	Better Business Bureau	Sarah Schmitt	314-600-XXXX	CBS Giving Wrong Information#Customer Not Getting Calls#Rule Rep	9/10/2015	9/16/2015	12:22	Satisfactorily Resolved
KS	Better Business Bureau	Carmen Figueroa	484-721-XXXX	Failure to escalate within CBS#Remote Call Forwarding/Call Diversion	9/11/2015	9/23/2015	13:42	Satisfactorily Resolved
OH	Better Business Bureau	Alberto Parente	440-543-XXXX		9/14/2015	9/25/2015	9:43	Satisfactorily Resolved

IL	Better Business Bureau	Rebecca Cox	618-741-XXXX	CBS Giving Wrong Information;#Rude Rep;#SVV (Visit Issue)	9/17/2015	9/30/2015 15:47	Satisfactorily Resolved
OK	Better Business Bureau	Richard Stauffer	717-793-XXXX	Fraud (Credit Card/Identity);#Inability to Talk to Rep (IVR)	9/21/2015	10/1/2015 9:30	Satisfactorily Resolved
AR	Executive	Rudolph Shokal	208-837-XXXX	Customer Not Getting Calls;#Inability to Talk to Rep - Hold Time	9/21/2015	9/25/2015 9:54	Satisfactorily Resolved
VA	Better Business Bureau	Sherry Lawton	423-963-XXXX	Fees: Payment/Funding;#Fees: Wireless/Admin/Regulatory	9/23/2015	10/7/2015 9:48	Satisfactorily Resolved
KY	Better Business Bureau	Tommy Southard	270-765-XXXX	Refund Check Delivery Times	9/24/2015	10/7/2015 9:55	Satisfactorily Resolved
GA	Better Business Bureau	Tamara Hamilton	404-734-XXXX	Rude Rep;#SVV (Visit Issue)	9/25/2015	10/15/2015 12:29	Satisfactorily Resolved
FL	Better Business Bureau	Sharita Sharp	517-250-XXXX	CBS Giving Wrong Information;#Rude Rep;#SVV (Visit Issue)	9/29/2015	10/21/2015 15:51	Satisfactorily Resolved
TN	Better Business Bureau	Gloria Brown	901-743-XXXX	CBS Giving Wrong Information;#Customer Not Getting Calls;#Inability to escalate within CBS	9/29/2015	10/14/2015 10:47	Satisfactorily Resolved
CO	Better Business Bureau	Phyllis Brennan	303-995-XXXX	CPNI;#Fees: Wireless/Admin/Regulatory;#Inability to Talk to Rep - Hold Time	10/1/2015	10/20/2015 8:40	Satisfactorily Resolved
KY	Executive	Valerie Prater	502-653-XXXX	Remote Call Forwarding/Call Diversion	10/2/2015	10/12/2015 8:53	Satisfactorily Resolved
WI	Better Business Bureau	Luis Colon	Inmate Complaint	Payment Not Posted	10/6/2015	10/14/2015 10:10	Satisfactorily Resolved
FL	Better Business Bureau	Ashley Early	863-800-XXXX	Payment Issues	10/7/2015	10/22/2015 14:41	Satisfactorily Resolved
NY	Executive	Jane Nordmark	973-723-XXXX	CPNI;#Unwanted Inmate Calls	10/7/2015	10/14/2015 11:11	Satisfactorily Resolved
IL	Better Business Bureau	Robert John	Inmate Complaint	180 Day Inactivity Policy	10/8/2015	10/19/2015 12:45	Satisfactorily Resolved
KY	Better Business Bureau	Jodi Kellman	859-533-XXXX	CBS Giving Wrong Information;#Cut Off Calls (COQ);#Failure to escalate within CBS	10/8/2015	10/23/2015 13:45	Satisfactorily Resolved
TX	Executive	Joe Shields	281-704-XXXX	Unwanted Inmate Calls	10/8/2015	10/12/2015 12:00	Satisfactorily Resolved
AR	Better Business Bureau	Peggy Netter	504-421-XXXX	Failure to escalate within CBS;#Inability to Talk to Rep (IVR);#Payment Not Posted	10/9/2015	10/22/2015 10:21	Satisfactorily Resolved
TX	Better Business Bureau	Bridget Stelly	936-653-XXXX	Billing Issues	10/9/2015	10/30/2015 9:10	Satisfactorily Resolved
OH	Friends and Family	Kelly Hill	937-559-XXXX	Cut Off Calls (COQ)	10/9/2015	10/9/2015 16:03	Satisfactorily Resolved
MT	Better Business Bureau	Stella Bullchild	406-868-XXXX	Cut Off Calls (COQ)	10/13/2015	10/22/2015 14:59	Satisfactorily Resolved
CA	Better Business Bureau	Dalia Cervantes	760-712-XXXX	CBS Giving Wrong Information;#Failure to escalate within CBS;#Information Request	10/15/2015	11/6/2015 9:52	Satisfactorily Resolved
TX	Better Business Bureau	Paul Schifino	310-213-XXXX	Fraud (Credit Card/Identity)	10/15/2015	11/6/2015 15:25	Satisfactorily Resolved
VA	Better Business Bureau	Keosha Lakeia Jones	434-944-XXXX	Failure to escalate within CBS;#Payment Not Posted;#Rude Rep	10/15/2015	10/27/2015 14:41	Satisfactorily Resolved
WI	Better Business Bureau	Cheryl Taylor	920-487-XXXX	CBS Giving Wrong Information;#Failure to escalate within CBS;#Payment Issues	10/16/2015	10/27/2015 14:07	Satisfactorily Resolved
FL	Better Business Bureau	Marjorie Waterman	305-949-XXXX	Cut Off Calls (COQ);#Inability to Talk to Rep (IVR)	10/19/2015	10/29/2015 16:39	Satisfactorily Resolved
CA	Better Business Bureau	Raquel Shull	909-533-XXXX	Inability to Talk to Rep (IVR);#Unwanted Inmate Calls	10/20/2015	10/28/2015 17:14	Satisfactorily Resolved
MI	Better Business Bureau	Theresa Little	708-715-XXXX	Cut Off Calls (COQ);#Inability to Talk to Rep - Hold Time;#SVV (Visit Issue)	10/21/2015	11/11/2015 17:14	Satisfactorily Resolved
MS	Better Business Bureau	Andrea Wells	662-403-XXXX	Remote Call Forwarding/Call Diversion	10/22/2015	11/11/2015 10:42	Satisfactorily Resolved
WI	Better Business Bureau	Oscar Garner	Inmate Complaint	Payment Not Posted	10/22/2015	11/9/2015 10:00	Satisfactorily Resolved
WI	Better Business Bureau	Ericka Thomas	Inmate Complaint	Payment Not Posted	10/22/2015	10/29/2015 17:01	Satisfactorily Resolved
NY	Better Business Bureau	John Brower	631-988-XXXX	CBS Giving Wrong Information;#Failure to escalate within CBS;#No Positive Acceptance	10/26/2015	11/2/2015 14:44	Satisfactorily Resolved
TX	Better Business Bureau	Sandra Dreyer	903-753-XXXX	Account/Billing Conversion;#Inability to Talk to Rep (IVR)	10/27/2015	10/29/2015 10:42	Satisfactorily Resolved
NC	Better Business Bureau	Thomas Gilroy	570-212-XXXX	Refund Issue	10/28/2015	11/5/2015 9:40	Satisfactorily Resolved
KY	Friends and Family	Anette Compton	859-537-XXXX	Payment Processing Time	10/30/2015	11/2/2015 16:30	Satisfactorily Resolved
AZ	Better Business Bureau	Nancy Stemo	910-366-XXXX	180 Day Inactivity Policy	11/3/2015	11/9/2015 9:44	Satisfactorily Resolved
TX	Better Business Bureau	Amanda Fuller	817-966-XXXX	Account/Billing Conversion;#Inability to Talk to Rep (IVR)	11/3/2015	11/11/2015 10:13	Satisfactorily Resolved
TX	Better Business Bureau	Felicia Frazier	318-918-XXXX	Account/Billing Conversion	11/3/2015	11/11/2015 9:52	Satisfactorily Resolved
FL	Better Business Bureau	Lori Long	561-360-XXXX	Cut Off Calls (COQ)	11/4/2015	11/24/2015 14:02	Satisfactorily Resolved
GA	Better Business Bureau	Keri Mitchell	678-768-XXXX	CBS Giving Wrong Information;#Fees: Wireless/Admin/Regulatory;#Rude Rep	11/4/2015	11/16/2015 10:05	Satisfactorily Resolved
FL	Better Business Bureau	Paula Georges	754-366-XXXX	Cut Off Calls (COQ)	11/6/2015	11/24/2015 12:58	Satisfactorily Resolved
KY	Better Business Bureau	Frances Cox	859-234-XXXX	Payment Not Posted	11/9/2015	11/17/2015 15:08	Satisfactorily Resolved
GA	Better Business Bureau	Chris Wallah	803-292-XXXX	Fees: Wireless/Admin/Regulatory;#Inability to Talk to Rep - Hold Time;#Rude Rep	11/10/2015	11/23/2015 9:46	Satisfactorily Resolved
TX	Better Business Bureau	Ca Wynn Owens	972-746-XXXX	CBS Giving Wrong Information;#Cut Off Calls (COQ);#Secure Instant Mail (SIM)	11/10/2015	12/4/2015 12:39	Satisfactorily Resolved

MI	Better Business Bureau	Iris Jolly	906-346-XXXX	CBS Giving Wrong Information;#Fees:	11/10/2015	12/2/2015 13:31	Satisfactorily Resolved
LA	Better Business Bureau	Paul De Rouen	Inmate Complaint	Wireless/Admin/Regulatory/Inability to Talk to Rep - Hold Time	11/12/2015	11/20/2015 16:06	Satisfactorily Resolved
AZ	Better Business Bureau	Janice Barker	208-520-XXXX	Refund Check Delivery Times	11/13/2015	11/30/2015 15:41	Satisfactorily Resolved
UT	Better Business Bureau	Earnest Aycock	480-435-XXXX	CBS Giving Wrong Information;#Rude Rep;#SVW (Visit Issue)	11/13/2015	12/7/2015 12:59	Satisfactorily Resolved
IL	Executive	Christine Hanna	309-509-XXXX	Blocked Accounts;#CBS Giving Wrong Information;#Payment Not	11/13/2015	11/19/2015 13:41	Satisfactorily Resolved
IL	Better Business Bureau	Betty Ann Brinson	912-739-XXXX	Payment Not Posted	11/16/2015	12/9/2015 15:26	Satisfactorily Resolved
NC	Better Business Bureau	Anthony Smith	434-296-XXXX	Out Off Calls (COG);#Failure to escalate within CBS;#Rude Rep	11/16/2015	12/9/2015 15:30	Satisfactorily Resolved
TX	Better Business Bureau	Lebisa West	832-935-XXXX	Cut Off Calls (COG)	11/19/2015	12/10/2015 10:27	Satisfactorily Resolved
CA	Better Business Bureau	Patrick Krewson	760-847-XXXX	Credit Card Usage Blocks - Velocity Rules	11/20/2015	12/14/2015 14:00	Satisfactorily Resolved
TX	Better Business Bureau	Mark Hempel	479-850-XXXX	Fraud (Credit Card/Identity)	11/23/2015	12/15/2015 15:10	Satisfactorily Resolved
CA	Executive	Todd Kaelin	Inmate	Information Request	11/23/2015	11/25/2015 8:39	Satisfactorily Resolved
CO	Better Business Bureau	Evangeline Castaneda	303-345-XXXX	SVW (Visit Issue)	12/1/2015	12/21/2015 13:22	Satisfactorily Resolved
FL	Better Business Bureau	Debra Starcher	330-400-XXXX	High Rates	12/3/2015	12/24/2015 12:15	Satisfactorily Resolved
TX	Better Business Bureau	Mary Durcan	214-806-XXXX	Tablet Issues	12/3/2015	12/21/2015 13:31	Satisfactorily Resolved
AR	Better Business Bureau	Laura Thompson	501-778-XXXX	Payment Issues	12/3/2015	12/24/2015 12:10	Satisfactorily Resolved
TX	Executive	Steven Akers	224-656-XXXX	Information Request	12/7/2015	12/18/2015 14:26	Satisfactorily Resolved
SC	Friends and Family	Shelly Williams	843-413-XXXX	Fees: Payment/Funding;#Inability to Talk to Rep (IVR)	12/7/2015	12/19/2015 8:41	Satisfactorily Resolved
TX	Executive	Bryan Mills	972-974-XXXX	Account Set Up	12/8/2015	12/10/2015 12:33	Satisfactorily Resolved
KY	Better Business Bureau	Sky Collins	502-299-XXXX	Billing Issues;#Failure to escalate within CBS;#Inability to Talk to	12/14/2015	1/5/2016 8:38	Satisfactorily Resolved
LA	Executive	Michela Conry	757-335-XXXX	Rep - Hold Time	12/17/2015	12/24/2015 11:54	Satisfactorily Resolved
CT	Better Business Bureau	Cheryl Vaughan	203-274-XXXX	Denies All Knowledge (DAK)	12/23/2015	1/13/2016 16:07	Satisfactorily Resolved
TX	Better Business Bureau	Ruthie Bright	903-592-XXXX	CBS Giving Wrong Information;#Inability to Talk to Rep - Hold	12/23/2015	1/12/2016 10:28	Satisfactorily Resolved
IN	Better Business Bureau	Tracy Smith	574-742-XXXX	Account Set Up;#Inability to Talk to Rep - Hold Time	12/23/2015	1/18/2016 11:36	Satisfactorily Resolved
IL	Better Business Bureau	Kira Patterson	618-540-XXXX	CBS Giving Wrong Information;#SVW (Visit Issue)	12/24/2015	1/13/2016 16:04	Satisfactorily Resolved
IL	Better Business Bureau	Elizabeth Pittman	618-334-XXXX	Cut Off Calls (COG)	12/29/2015	1/12/2016 10:04	Satisfactorily Resolved
TX	Executive	Detective B. Uppens	972-874-XXXX	Failure to escalate within CBS;#Rude Rep;#Unwanted Inmate Calls	12/31/2015	2/1/2016 13:40	Satisfactorily Resolved
IL	Better Business Bureau	Marie Collins	352-486-XXXX	CPNI;#Fraud (Credit Card/Identity)	1/4/2016	1/19/2016 11:58	Satisfactorily Resolved
UT	Better Business Bureau	Thomas Pryor	801-969-XXXX	CBS Giving Wrong Information;#Refund Issue	1/5/2016	1/18/2016 13:37	Satisfactorily Resolved
GA	Better Business Bureau	Valencia Tye	803-361-XXXX	180 Day Inactivity Policy;#CPNI	1/6/2016	1/22/2016 15:35	Satisfactorily Resolved
IL	Better Business Bureau	Riley Fleming	Inmate	CBS Giving Wrong Information;#Inability to Talk to Rep - Hold	1/6/2016	1/20/2016 14:48	Satisfactorily Resolved
IL	Better Business Bureau	Lorenzo Ellison	Inmate	Time;#Refund Issue	1/6/2016	1/19/2016 12:45	Satisfactorily Resolved
TX	Better Business Bureau	Hali Szazymaki	214-460-XXXX	Payment Not Posted	1/11/2016	1/26/2016 9:10	Satisfactorily Resolved
n/a	Better Business Bureau	Roberta Kostick	215-768-XXXX	Payment Not Posted	1/12/2016	1/26/2016 9:57	Satisfactorily Resolved
TX	Better Business Bureau	Vickie Barnhill	208-286-XXXX	CBS Giving Wrong Information;#No Positive Acceptance	1/13/2016	1/26/2016 9:45	Satisfactorily Resolved
TX	Better Business Bureau	Dorna Mosbar	512-259-XXXX	Account Set Up;#CPNI	1/14/2016	1/28/2016 16:11	Satisfactorily Resolved
TX	Better Business Bureau	Rechel Paige	512-897-XXXX	CBS Giving Wrong Information;#Unwanted Inmate Calls	1/14/2016	1/28/2016 16:11	Satisfactorily Resolved
IN	Better Business Bureau	Thomas Brown	317-525-XXXX	Account/Billing Conversion;#Payment Not Posted	1/14/2016	1/27/2016 16:57	Satisfactorily Resolved
LA	Better Business Bureau	Theresa Cuarenta	347-871-XXXX	180 Day Inactivity Policy;#Account Set Up	1/14/2016	1/27/2016 16:46	Satisfactorily Resolved
IL	Better Business Bureau	Meghan Daniels	312-890-XXXX	Fees: Wireless/Admin/Regulatory;#Payment Issues	1/18/2016	1/29/2016 10:00	Satisfactorily Resolved
PA	Executive	Walker Chruby	814-231-XXXX	Account Set Up;#Refund Issue	1/19/2016	2/4/2016 13:09	Satisfactorily Resolved
CO	Better Business Bureau	Catherine Whitaker	719-289-XXXX	Payment Issues	1/19/2016	1/22/2016 14:53	Satisfactorily Resolved
FL	Better Business Bureau	Kevin Yeager	352-653-XXXX	Inability to Talk to Rep (IVR);#No Positive Acceptance	1/20/2016	2/5/2016 15:13	Satisfactorily Resolved
IL	Better Business Bureau	Melissa Bryant	815-823-XXXX	Fees: Wireless/Admin/Regulatory;#High Rates	1/22/2016	2/4/2016 10:37	Satisfactorily Resolved
TX	Better Business Bureau	Dana Barron	214-466-XXXX	Failure to escalate within CBS;#Fees: Wireless/Admin/Regulatory	1/26/2016	2/9/2016 16:28	Satisfactorily Resolved
IL	Better Business Bureau	Krista Bok a	217-779-XXXX	CBS Giving Wrong Information;#Customer Not Getting Calls	1/26/2016	2/5/2016 16:51	Satisfactorily Resolved
IL	Better Business Bureau	Kim Dixon	773-568-XXXX	Refund Issue	1/27/2016	2/9/2016 15:45	Satisfactorily Resolved
WI	Better Business Bureau	Mayfield Fields	Inmate	90 Day Inactivity Policy;#Inability to Talk to Rep - Hold Time	2/1/2016	2/18/2016 13:38	Satisfactorily Resolved
AZ	Better Business Bureau	Penela Goodway	928-890-XXXX	CBS Giving Wrong Information;#Cut Off Calls (COG);#Fees:	2/1/2016	2/4/2016 10:21	Satisfactorily Resolved
				Payment/Funding	2/2/2016	2/15/2016 12:44	Satisfactorily Resolved
				CBS Giving Wrong Information;#SVW (Visit Issue)			

KS	Better Business Bureau	Melissa McPherson	316-484-XXXX	Fees: Wireless/Admin/Regulatory;#Inability to Talk to Rep - Hold Time;#SVV (Visit Issue) CBS Giving Wrong Information;#Failure to escalate within CBS;#Refund Issue	6/30/2016 14:58	Satisfactorily Resolved
TX	Better Business Bureau	Lora Mashaw	214-837-XXXX	CBS Giving Wrong Information;#Failure to escalate within CBS;#Refund Issue	6/27/2016	Satisfactorily Resolved
TX	Executive	Hal Wallace	469-794-XXXX	Payment Issues	6/27/2016	Satisfactorily Resolved
FL	Better Business Bureau	Jaleesa Mack	904-444-XXXX	Payment Issues	7/14/2016 11:14	Satisfactorily Resolved
GA	Better Business Bureau	Robbin Anderson	702-704-XXXX	CBS Giving Wrong Information;#No Positive Acceptance	7/15/2016 9:48	Satisfactorily Resolved
TX	Better Business Bureau	Sylvia Morris	713-984-XXXX	CBS Giving Wrong Information;#Refund Issue	7/4/2016	Satisfactorily Resolved
AZ	Better Business Bureau	Kasey Hodges	11312013	CBS Giving Wrong Information;#Payment Issues	7/26/2016 13:49	Satisfactorily Resolved
CO	Better Business Bureau	Kathryn Konczek	307-231-XXXX	Payment Issues	7/15/2016	Satisfactorily Resolved
FL	Better Business Bureau	Michael Marston	904-239-XXXX	CBS Giving Wrong Information;#Fraud (Credit Card/Identity)	7/19/2016	Satisfactorily Resolved
IL	Better Business Bureau	Antoine Watson	Inmate	Billing Issues;#CRNI	7/19/2016	Satisfactorily Resolved
n/a	Better Business Bureau	Samantha Jones	281-889-XXXX	High Rates Failure to escalate within CBS;#Inability to Talk to Rep	8/2/2016 9:27	Satisfactorily Resolved
VA	Better Business Bureau	Douglas Kidd	434-473-XXXX	(IVR);#Payment Issues	7/21/2016	Satisfactorily Resolved
FL	Executive	Christina Mathieu	850-736-XXXX	SVV (Visit Issue)	8/19/2016	Satisfactorily Resolved
AZ	Better Business Bureau	Karen McClean	928-978-XXXX	SVV (Visit Issue)	8/2/2016	Satisfactorily Resolved
TX	Friends and Family	Joanne Jones	409-789-XXXX	Billing Issues	8/4/2016	Satisfactorily Resolved
PA	Better Business Bureau	Vaughn MacGregor	814-795-XXXX	Unwanted Inmate Calls	8/5/2016	Satisfactorily Resolved
IL	Better Business Bureau	Tonja Scott-Pate	563-570-XXXX	Unwanted Dialer Calls	8/17/2016 13:29	Satisfactorily Resolved
CO	Better Business Bureau	Amanda DiMaio	219-928-XXXX	SVV (Visit Issue)	8/10/2016	Satisfactorily Resolved
TX	Executive	Jon Turner	813-817-XXXX	Unwanted Inmate Calls	8/12/2016	Satisfactorily Resolved
TX	Executive	Joanne Jones	409-789-XXXX	High Rates	8/12/2016	Satisfactorily Resolved
AR	Better Business Bureau	Heath Stocks	Inmate	Cut Off Calls (COQ)	8/16/2016	Satisfactorily Resolved
AZ	Better Business Bureau	Maria Harper	623-340-XXXX	SVV (Visit Issue)	8/30/2016 12:14	Satisfactorily Resolved
CO	Better Business Bureau	Katherin Trujillo	970-628-XXXX	CBS Giving Wrong Information;#High Rates	8/23/2016	Satisfactorily Resolved
KS	Better Business Bureau	Britney Williamson	785-250-XXXX	Inability to Talk to Rep (IVR);#SVV (Visit Issue)	8/25/2016	Satisfactorily Resolved
OR	Better Business Bureau	Barb O'Neill	503-990-XXXX	Billing Issues;#CBS Giving Wrong Information	8/30/2016	Satisfactorily Resolved
WI	Better Business Bureau	Rebecca Harp	414-760-XXXX	Payment Issues	8/31/2016	Satisfactorily Resolved
TX	Better Business Bureau	Cara Rhodes	608-931-XXXX	CBS Giving Wrong Information;#Failure to escalate within CBS;#Payment Issues	9/2/2016	Satisfactorily Resolved
IN	Better Business Bureau	Sabrina Dini	574-575-XXXX	Rude Rep;#SVV (Credit/Payment Issue)	9/17/2016	Satisfactorily Resolved
MA	Executive	Albert Beaure	413-464-XXXX	Payment Issues	9/12/2016	Satisfactorily Resolved
FL	Better Business Bureau	Terry Hiley	407-878-XXXX	Cut Off Calls (COQ)	9/14/2016	Satisfactorily Resolved
IA	Better Business Bureau	Michelle Gujjarro	402-679-XXXX	CBS Giving Wrong Information;#Failure to escalate within CBS;#SVV (Visit Issue)	9/14/2016	Satisfactorily Resolved
IL	Better Business Bureau	Leonard Garner	Inmate	Billing Issues	9/15/2016	Satisfactorily Resolved
FL	Friends and Family	Tracy Stokes	850-635-XXXX	Payment Issues	9/15/2016	Satisfactorily Resolved
UT	Better Business Bureau	Kacy Schauer	801-528-XXXX	Cut Off Calls (COQ);#Failure to escalate within CBS	9/19/2016	Satisfactorily Resolved
TX	Better Business Bureau	Renata Steward	224-587-XXXX	Payment Issues	9/20/2016	Satisfactorily Resolved
TX	Executive	Trish Green	512-775-XXXX	Unwanted Inmate Calls	9/20/2016	Satisfactorily Resolved
FL	Friends and Family	Wanda Davis	850-638-XXXX	Call Quality;#Cut Off Calls (COQ)	9/20/2016	Satisfactorily Resolved
FL	Better Business Bureau	Masha Leytner	850-990-XXXX	Oil Quality	9/21/2016	Satisfactorily Resolved
FL	Friends and Family	Jennifer Oborn	352-419-XXXX	SVV (Visit Issue)	9/23/2016	Satisfactorily Resolved
TX	Better Business Bureau	Regina Nelson	512-573-XXXX	SVV (Visit Issue)	9/27/2016	Satisfactorily Resolved
IL	Better Business Bureau	Anthony Brown	Inmate	Payment Issues	9/29/2016	Satisfactorily Resolved
TX	Executive	Mary Brooks	334-803-XXXX	Billing Issues	9/29/2016	Satisfactorily Resolved
AZ	Better Business Bureau	Matthew Brown	703-350-XXXX	SVV (Visit Issue)	10/13/2016 10:02	Satisfactorily Resolved
FL	Better Business Bureau	Maria Lopez	954-663-XXXX	Cut Off Calls (COQ)	9/30/2016	Satisfactorily Resolved
IL	Executive	Mays Schenwer	847-525-XXXX	SVV (Visit Issue)	10/21/2016 10:02	Satisfactorily Resolved
IL	Better Business Bureau	Angela Honjo	312-730-XXXX	Credit Card Usage Blocks - Velocity Rules	10/6/2016	Satisfactorily Resolved
KY	Better Business Bureau	Ramona Osborne	513-960-XXXX	Refund Issue	10/18/2016	Satisfactorily Resolved
IL	Better Business Bureau	Michelle Wilhite	815-263-XXXX	CBS Giving Wrong Information;#Cut Off Calls (COQ)	10/20/2016	Satisfactorily Resolved
TX	Better Business Bureau	Robert Waites	936-449-XXXX	Billing Issues;#Inability to Talk to Rep (IVR)	10/21/2016	Satisfactorily Resolved
TN	Better Business Bureau	Mike Welsh	931-510-XXXX	SVV (Visit Issue)	10/25/2016	Satisfactorily Resolved
PA	Better Business Bureau	Shamira Ellis	814-386-XXXX	Payment Issues	10/27/2016	Satisfactorily Resolved
WI	Better Business Bureau	Lesia Hawkey	715-316-XXXX	Cut Off Calls (COQ);#SVV (Visit Issue)	11/10/2016	Satisfactorily Resolved
TX	Friends and Family	Tom Waitinger	512-422-XXXX	High Rates	11/10/2016	In progress
LA	Better Business Bureau	Michelle Jackson	225-249-XXXX		11/15/2016	Satisfactorily Resolved
AK	Better Business Bureau	Penny Postal	856-667-XXXX		11/29/2016	In progress
CA	Better Business Bureau	Jennifer McClain	562-296-XXXX		11/29/2016	In progress

KS	Better Business Bureau	Traci Cook	785-829-XXXX	Refund Issue	11/29/2016	12/2/2016 11:06	Satisfactorily Resolved
NJ	Better Business Bureau	Brian Whitney	973-955-XXXX	Billing Issues	11/30/2016	12/2/2016 10:44	Satisfactorily Resolved
IL	Friends and Family	Antoine Watson	N/A		12/1/2016		In progress
FL	Better Business Bureau	Julianne Bazile	754-244-XXXX		12/6/2016		In progress
IL	Executive	Jerry Brandt	573-655-XXXX		12/6/2016		In progress

Please note that Securus has redacted customer identifying information for telephone numbers from the complaint information provided. Federal, 47 CFR, SubpartJ-Customer Proprietary Network Information ("CPNI") rules protect customers from the release of such information without their consent.

Agency complaints

State	Agency	Customer Name	Phone Number*	Complaint	Date Received	Resolved	Resolution
OH	PSC	Roger Sharnhart	740-776-XXXX	Automated Calls	1/3/2013	1/7/2013	Satisfactorily Resolved
AK	PSC	Kevin Kambak	(907) 747-XXXX	Automated Calls	1/4/2013	1/4/2013	Satisfactorily Resolved
ND	AGO	Arlene Nilfische	701-222-XXXX	Automated Calls	1/9/2013	1/9/2013	Satisfactorily Resolved
IL	PSC	Angelo Pargia	(708) 293-XXXX	Pay Now	1/9/2013	1/11/2013	Satisfactorily Resolved
MD	FCC	Jamies Widerhouse	XXXX	RCF (Call diversion)	1/9/2013	1/14/2013	Satisfactorily Resolved
TX	FCC	Cynthia Carpenter	906-250-XXXX	Billing Dispute	1/9/2013	Responded	Satisfactorily Resolved
LA	PSC	Lee Brown	(318) 635-XXXX	3-way detection	1/10/2013	1/11/2013	Satisfactorily Resolved
WI	DOA	William Counts	Inmate complaint 211570	Refund	1/14/2013	1/17/2013	Satisfactorily Resolved
AK	RCOA	Ian Coleman	907-720-XXXX	Account Inquiry	1/16/2013	1/24/2014	Satisfactorily Resolved
TX	PUC	Zerick Waites	214-388-XXXX	Billing Dispute	1/17/2013	1/21/2013	Satisfactorily Resolved
AK	FCC	Suzanne Clifton	907-223-XXXX	High Rates	1/17/2013	1/23/2013	Satisfactorily Resolved
NV	PUC	Tommy Olsen	312-787-XXXX	Automated Calls	1/18/2013	1/18/2013	Satisfactorily Resolved
GA	FCC	Michelle Bush	434-XXXX	High Rates	1/24/2013	1/28/2013	Satisfactorily Resolved
WA	FCC	Noel Woodard	907-224-XXXX	High Rates	1/24/2013	1/29/2013	Satisfactorily Resolved
MO	AGO	Deborah Zumwalt	636-937-XXXX	Billing Dispute	1/29/2013	2/5/2013	Satisfactorily Resolved
MI	AGO	Michael Mijerek	269-845-XXXX	Billing Dispute	1/30/2013	1/31/2013	Satisfactorily Resolved
AZ	PUC	Judith Wiseman	480-393-XXXX	Out of Calls	1/30/2013	2/5/2013	Satisfactorily Resolved
TN	AGO	Claudette Kerr	423-295-XXXX	Refund	2/1/2013	2/6/2013	Satisfactorily Resolved
OH	FCC	Doris Harp	419-428-XXXX	Billing dispute	2/6/2013	2/7/2013	Satisfactorily Resolved
TX	FCC	Cynthia Carpenter	(906) 250-6954	Billing dispute	2/6/2013	2/27/2013	Satisfactorily Resolved
GA	FCC	Ida Vereen	(678) 973-0911	System Issues(Calls wont connect)	2/6/2013	2/28/2013	Satisfactorily Resolved
MI	AGO	Robert Levi	(248) 366-4412	Refund	2/11/2013	2/13/2013	Satisfactorily Resolved
MN	Escalation	Rose Holmes	N/A	Security Issue	2/12/2013	2/18/2013	Satisfactorily Resolved
GA	FCC	Michelle Bush	434-XXXX	Multiple Issues	2/12/2013	2/19/2013	Satisfactorily Resolved
TN	FCC	Clifford Taddler	(423) 293-4457	Billing dispute	2/13/2013	2/15/2013	Satisfactorily Resolved
WI	DOA	Inmate Dominique Robinson	Inmate#313512	Billing Dispute	2/14/2013	2/25/2013	Satisfactorily Resolved
NC	DOA	Henry Armfield	336-312-XXXX	Unwanted Calls	2/18/2013	2/19/2013	Satisfactorily Resolved
MD	DOA	Angela Callahan	410-409-XXXX	Out of Calls	2/20/2013	2/22/2013	Satisfactorily Resolved
WI	Escalation	Bert Koltz	608-770-XXXX	(Alleged) Telemarketing Calls	2/22/2013	2/26/2013	Satisfactorily Resolved
LA	AGO	Nettie Boudoin	337-256-XXXX	Blocked Calls	2/25/2013	2/25/2013	Satisfactorily Resolved
MO	PUC	Beverly Watkins	573-793-XXXX	Unwanted Calls	2/25/2013	2/27/2013	Satisfactorily Resolved
WI	FCC	William Counts	Inmate Complaint	Refund	2/25/2013	3/4/2013	Satisfactorily Resolved
OH	DOA	Craig Wolin	(419) 333-XXXX	Billing dispute	2/27/2013	3/4/2013	Satisfactorily Resolved
MN	FCC	Richard Harwell	952-456-XXXX	Refund	2/28/2013	3/15/2013	Satisfactorily Resolved
MO	AGO	William D. Rohlf	417-343-XXXX	Call Diversions/ Advertising Inquiry	3/3/2013	3/22/2013	Satisfactorily Resolved
OH	FCC	Stephanie Keaton	614-260-XXXX	Billing Explanation	3/7/2013	4/1/2013	Satisfactorily Resolved
TN	FCC	Daniel Franks	615-274-XXXX	High Rates	3/7/2013	4/3/2013	Satisfactorily Resolved
TN	FCC	Phyllis Swayze	423-288-XXXX	Call Diversion	3/7/2013	4/19/2013	Satisfactorily Resolved

AK	PSC	Carla Cheatham	907-746-XXXX	Billing Dispute	3/14/2013	3/29/2013	Satisfactorily Resolved
NC	PSC	Helen Barbour	919-772-XXXX	Lec Billing Changes	3/15/2013	3/21/2013	Satisfactorily Resolved
OH	PUC	David Hamilton	740-646-XXXX	Denies All Knowledge	3/18/2013	3/27/2013	Satisfactorily Resolved
AK	PUC	Sally Hinkley	904-646-XXXX	Payment Not Posted	3/22/2013	3/27/2013	Satisfactorily Resolved
NC	PUC	Rosie Henderson	704-399-XXXX	Billing Explanation	3/22/2013	4/5/2013	Satisfactorily Resolved
KY	FCC	Ryan Estridge	606-593-XXXX	CNGC	3/26/2013	4/2/2013	Satisfactorily Resolved
MT	PUC	Judy Johnson	406-397-XXXX	Lec Billing Changes	3/27/2013	4/1/2013	Satisfactorily Resolved
MS	FCC	Crystal Davison	601-485-XXXX	Billing Explanation	3/27/2013	4/9/2013	Satisfactorily Resolved
OH	PUC	Mary Potts	937-283-XXXX	Denies All Knowledge	3/29/2013	4/3/2013	Satisfactorily Resolved
AZ	AGO	William Carr	520-647-XXXX	Denies All Knowledge	3/29/2013	4/8/2013	Satisfactorily Resolved
FL	PSC	Richard F. Bryant	B2102	Rates	4/1/2013	5/2/2013	Satisfactorily Resolved
TX	FCC	Barbara Dickson	214-331-XXXX	Billing Dispute	4/7/2013	4/16/2013	Satisfactorily Resolved
OH	Complaint	James Wright	330-447-XXXX	Unwanted Calls	4/8/2013	4/8/13	Satisfactorily Resolved
TX	PUC	Zenick Waites	214-388-XXXX	Billing Dispute	4/8/2013	11/13/2013	Satisfactorily Resolved
OH	FCC	Beth Smith	330-314-XXXX	Prepaid Overage	4/10/2013	4/11/2013	Satisfactorily Resolved
IL	FCC	Latonya Maddox	XXXX	High Rates/Cons Call Home	4/10/2013	4/11/2013	Satisfactorily Resolved
IL	FCC	Angelo Targia	(708) 293-0288	Billing Dispute	4/10/2013	4/12/2013	Satisfactorily Resolved
LA	FCC	Ronald Irby	(713) 726-8051	High Rates	4/10/2013	5/9/2013	Satisfactorily Resolved
WA	Complaint	Justin Caseday	(360) 931-0859	Credit Card Fraud	4/11/2013	4/12/2013	Satisfactorily Resolved
TX	PSC	HL Legg	(979) 535-7332	Denies All Knowledge	4/12/2013	4/24/2013	Satisfactorily Resolved
IL	AGO	Martha Benson	(847) 664-0012	Dropped Calls	4/15/2013	4/17/2013	Satisfactorily Resolved
FL	PSC	Thomas Harris	(071281V4204)	Approved Calling List (Inquiry)	4/16/2013	4/23/2013	Satisfactorily Resolved
TX	FCC	Garland Hardin	903-641-XXXX	Billing Dispute	4/17/2013	4/24/2013	Satisfactorily Resolved
IL	PSC	Howard Leroy King	708-770-XXXX	Billing Dispute	4/17/2013	4/26/2013	Satisfactorily Resolved
AL	PSC	Janet Adams	907-562-XXXX	CNGC	4/17/2013	4/24/2013	Satisfactorily Resolved
WI	PSC	Lenora Davis	XXXX	Billing Dispute	4/22/2013	4/26/2013	Satisfactorily Resolved
AZ	PUC	Neille Fay Kohl	602-715-XXXX	Billing Dispute	4/22/2013	4/29/2013	Satisfactorily Resolved
FL	FCC	Frank Martell	954-483-XXXX	Billing Dispute	4/24/2013	5/8/2013	Satisfactorily Resolved
AZ	PSC	Sam Alibrando	273-XXXX	CNGC	4/26/2013	5/3/2013	Satisfactorily Resolved
IL	FCC	Claudia Whaley	893-XXXX	Block	5/1/2013	5/13/2013	Satisfactorily Resolved
AZ	FCC	James Jones	250-XXXX	Rates	5/1/2013	5/14/2013	Satisfactorily Resolved
MD	FCC	Inmate#4280-206	Inmate#4280-206	Rates	5/6/2013	5/24/2013	Satisfactorily Resolved
ND	AGO	Barbara Kappie	(701) 720-XXXX	Billing Dispute	5/10/2013	5/21/2013	Satisfactorily Resolved
OH	FCC	Carol Mac Donald	330-264-XXXX	CNGC	5/22/2013	5/23/2013	Satisfactorily Resolved
TX	FCC	Afroz Burgess	713-436-XXXX	Billing Dispute	5/22/2013	6/20/2013	Satisfactorily Resolved
IL	FCC	Inmate Willie Fulliove	Inmate#RC5933	Rate Inquiry	5/29/2013	6/3/2013	Satisfactorily Resolved
MO	AGO	Bill White	XXXX	Block	5/29/2013	6/5/2013	Satisfactorily Resolved
AR	AGO	Clay Outten	(479) 636-XXXX	Block	5/31/2013	6/21/2013	Satisfactorily Resolved
NC	PSC	Philip L Bearman	336-693-XXXX	Automated Calls	6/3/2013	6/10/2013	Satisfactorily Resolved
IL	FCC	Alethia McCall	773-952-XXXX	RCF (Call diversion)	6/5/2013	6/14/2013	Satisfactorily Resolved
OH	PSC	Richard Orgel	419-242-XXXX	Billing Dispute	6/12/2013	6/17/2013	Satisfactorily Resolved
CT	AGO	Al Burmin	(203) 600-XXXX	Automated Calls	6/13/2013	6/26/2013	Satisfactorily Resolved

PA	AGO	Maria Czulewicz	(814) 879-XXXX	Billing Dispute	6/18/2013	7/11/2013	Satisfactorily Resolved
LA	FCC	Lois Blanchard	(985) 449-XXXX	Exceeded PVP	6/19/2013	7/5/2013	Satisfactorily Resolved
CT	AGO	Lawrence Mansy	(203) 524-XXXX	Automated Calls	6/20/2013	6/25/2013	Satisfactorily Resolved
TX	AGO	Michael Barnes	Inmate# 259445	Billing Dispute	6/20/2013	8/1/2013	Satisfactorily Resolved
IL	AGO	David N. Sigler	815-895-XXXX	Block	6/24/2013	7/3/2013	Satisfactorily Resolved
OK	FCC	Paul King	405-797-XXXX	Quality of Service	6/26/2013	7/9/2013	Satisfactorily Resolved
LA	AGO	Henrietta S. McCrary	225-755-XXXX	Billing Dispute	6/28/2013	7/19/2013	Satisfactorily Resolved
OH	PSC	Diane Love	440-839-XXXX	Billing Dispute	7/1/2013	7/9/2013	Satisfactorily Resolved
IL	AGO	Chrysalis Chisim	773-997-XXXX	Fraud	7/9/2013	7/23/2013	Satisfactorily Resolved
IA	FCC	Penny Hycyshyn	319-390-XXXX	Automated Messages	7/10/2013	7/11/2013	Satisfactorily Resolved
FL	FCC	Kathy Pardee	863-658-XXXX	RCF (Call diversion)	7/10/2013	7/16/2013	Satisfactorily Resolved
IL	FCC	Inmate Willie Fulllove	Inmate#R C5933	Rate Inquiry	7/10/2013	7/26/2013	Satisfactorily Resolved
AK	PSC	Inmate Jack Ibach/ Judi Fairbanks	425-821-XXXX	CNGC	7/11/2013	7/18/2013	Satisfactorily Resolved
IN	AGO	Indiana AGO Complaint	XXXX	Automated Calls	7/11/2013	7/23/2013	Satisfactorily Resolved
IL	AGO	Art Nelson	Inmate# 86268	Billing Dispute	7/11/2013	7/25/2013	Satisfactorily Resolved
NC	AGO	Mary Jo Jenkins	828-989-XXXX	Automated Calls	7/16/2013	7/31/2013	Satisfactorily Resolved
IL	AGO	Jemaine Carpenter	Inmate# B-32167	Approved Calling List (Inquiry)	7/18/2013	8/6/2013	Satisfactorily Resolved
MO	FCC	Francine Webb	314-921-XXXX	Billing Inquiry	7/31/2013	8/21/2013	Satisfactorily Resolved
IL	AGO	Jemaine Carpenter	Inmate Complaint	Block	8/3/2013	8/6/2013	Satisfactorily Resolved
WI	DCA	Reynold Moore	Inmate Complaint	Refund Not Receive	8/6/2013	8/15/2013	Satisfactorily Resolved
WA	AGO	Brian Halleitt	(509) 493-1928	Billing Dispute	8/8/2013	8/12/2013	Satisfactorily Resolved
IL	AGO	Raphael Cameron	Inmate Complaint	Refund Not Receive	8/8/2013	8/13/2013	Satisfactorily Resolved
WI	PSC	Jimmie Miller	Inmate Complaint	Billing Dispute	8/9/2013	8/14/2013	Satisfactorily Resolved
WA	AGO	Linda Marie Ford	253-466-XXXX	Automated Calls	8/12/2013	8/16/2013	Satisfactorily Resolved
WA	AGO	James Browder	360-319-XXXX	Denies All Knowledge	8/12/2013	8/20/2013	Satisfactorily Resolved
AZ	AGO	Elizbeth Gipple	928-402-XXXX	Billing Dispute	8/15/2013	8/22/2013	Satisfactorily Resolved
FL	DCA	Yvonne Hall	813-887-XXXX	Refund Issue: 180 Day Policy	8/20/2013	9/4/2013	Satisfactorily Resolved
OR	FCC	Jessica Jensen	714-585-XXXX	RCF (Call diversion)	8/21/2013	9/13/2013	Satisfactorily Resolved
PA	FCC	Paula Anderson	570-275-XXXX	Rates	8/21/2013	9/17/2013	Satisfactorily Resolved
NC	PSC/PUC	James Crawford	910-805-XXXX	Automated Calls	8/25/2013	9/1/2013	Satisfactorily Resolved
WA	AGO	Patricia Damford	425-454-XXXX	Denies All Knowledge	8/28/2013	9/16/2013	Satisfactorily Resolved
AL	FCC	Charles Ware	256-337-XXXX	High Rates	8/28/2013	9/17/2013	Satisfactorily Resolved
KY	FCC	Cathy Dowell	859-638-XXXX	High Rates	9/4/2013	9/19/2013	Satisfactorily Resolved
KY	FCC	Nathaniel Gerhart	502-296-XXXX	Account Inquiry	9/4/2013	9/24/2013	Satisfactorily Resolved
TX	FCC	Cleo Giddens	302-678-XXXX	Refund Not Receive	9/4/2013	10/3/2013	Satisfactorily Resolved
TX	FCC	Ruby Prado	512-665-XXXX	Cut Off Call	9/4/2013	10/31/2013	Satisfactorily Resolved
FL	DACS	Robert Anthony Stahl	386-330-XXXX	Refund Not Receive	9/9/2013	9/19/2013	Satisfactorily Resolved
TX	FCC	Caryn Baker	281-984-XXXX	Automated Calls	9/11/2013	9/23/2013	Satisfactorily Resolved
CA	FCC	Bruce Grant	650-595-XXXX	High Rates	9/18/2013	9/25/2013	Satisfactorily Resolved
CA	FCC	Margaret Childers	559-674-XXXX	High Rates	9/18/2013	9/30/2013	Satisfactorily Resolved
MA	FCC	Randa Il Huston	781-854-XXXX	High Rates	9/18/2013	10/1/2013	Satisfactorily Resolved
NC	DOJ	Betty W. Ross	919-467-XXXX	Billing Dispute	9/19/2013	9/26/2013	Satisfactorily Resolved

TX	FCC	Ginger Coleman	470-362-XXXX	Call Quality	10/2/2013	10/7/2013	Satisfactorily Resolved
AK	DOATCP	Toni Kirschenmann	509-966-XXXX	Blocked	10/7/2013	10/16/2013	Satisfactorily Resolved
OH	AGO	Susan Voegell	330-499-XXXX	Denies All Knowledge	10/15/2013	10/23/2013	Satisfactorily Resolved
CA	PUC	Shawn Woodall	Inmate Complaint	Refund Not Receive	10/29/2013	11/1/2013	Satisfactorily Resolved
CO	FCC	Kay Ferro	970-641-XXXX	DAK	10/30/2013	11/1/2013	Satisfactorily Resolved
FL	FCC	Neko Barlow	407-470-XXXX	Cut Off Call	11/6/2013	12/4/2013	Satisfactorily Resolved
AR	AGO	Scott McKenzie	870-219-XXXX	Billing Dispute	11/6/2013	11/21/2013	Satisfactorily Resolved
IN	FCC	Edward Bay	812-277-XXXX	Pay Now	11/13/2013	12/13/2013	Satisfactorily Resolved
LA	PUC	Iva Hanna	318-673-XXXX	Cut off Calls	11/13/2013	12/19/2013	Satisfactorily Resolved
FL	FCC	Douglas Cliché	(352) 359-7972	High Rates	11/20/2013	11/18/2013	Satisfactorily Resolved
IL	AGO	John Gill	Inmate Complaint	Refund Not Receive	11/22/2013	11/25/2013	Satisfactorily Resolved
MI	FCC	L.G. Brown	989-292-XXXX	RCF (Call diversion)	12/4/2013	12/16/2013	Satisfactorily Resolved
IN	FCC	Jennifer Swfyd	850-454-XXXX	Refund	12/4/2013	12/23/2013	Satisfactorily Resolved
IN	RCOA	Andrea Fornier	812-870-XXXX	RCF Block	12/6/2013	12/23/2013	Satisfactorily Resolved
TX	FCC	Bonifacio Duran	512-921-XXXX	RCF (Call diversion)	12/11/2013	1/6/2014	Satisfactorily Resolved
CA	FCC	Annette Russ	530-680-XXXX	High Rates	12/11/2013	1/7/2014	Satisfactorily Resolved
TX	FCC	Kate Kindelspire	361-728-XXXX	RCF (Call diversion)	12/11/2013	1/7/2014	Satisfactorily Resolved
TX	FCC	Ms. C. Carpenter	906-250-XXXX	Billing Dispute	12/12/2013	1/3/2014	Satisfactorily Resolved
AK	PUC	Alan Newby	907-488-XXXX	High Rates	12/12/2013	12/17/2013	Satisfactorily Resolved
AK	RCOA	Arlene Chapman	907-373-XXXX	Account Inquiry	12/13/2013	12/20/2013	Satisfactorily Resolved
MD	AGO	Cassandra Ann Brown	573-291-XXXX	Denies All Knowledge	12/13/2013	1/13/2014	Satisfactorily Resolved
NM	DOA	Sandoval	Inmate Complaint	Payment Posting Delay	12/17/2013	1/20/2014	Satisfactorily Resolved
CA	FCC	Jeff McPherson	619-333-XXXX	RCF (Call diversion)	1/2/2014	1/15/2014	Satisfactorily Resolved
CA	FCC	Steven Nair	470-208-XXXX	RCF (Call diversion)	1/2/2014	1/17/2014	Satisfactorily Resolved
AR	FCC	Wilma Niles	501-318-XXXX	Payment Posting Delay	1/2/2014	2/4/2014	Satisfactorily Resolved
LA	DOJ	Patricia Frey	225-242-XXXX	Billing Dispute	1/6/2014	1/14/2014	Satisfactorily Resolved
IL	AGO	John Gill	Inmate Complaint	Refund	1/9/2014	1/22/2014	Satisfactorily Resolved
PR	FCC	Rosela Tauli	787-790-XXXX	Billing Dispute	1/9/2014	1/27/2014	Satisfactorily Resolved
MA	FCC	Elizabeth Schaul	216-272-XXXX	High Rates	1/9/2014	1/28/2014	Satisfactorily Resolved
AK	RCOA	Richard Hudson	907-452-XXXX	Billing Dispute	1/10/2014	1/10/2014	Satisfactorily Resolved
FL	DOJ	Wesley Charles Gager	352-562-XXXX	Video Visitation	1/14/2014	2/11/2014	Satisfactorily Resolved
AR	PSC	Debbie Cossley	501-743-XXXX	Billing Dispute	1/16/2014	1/27/2014	Satisfactorily Resolved
IL	AGO	Karen Ward	773-287-XXXX	Refund Issue: 180 Day Policy	1/16/2014	1/29/2014	Satisfactorily Resolved
TX	FCC	Derek Smith	832-372-XXXX	High Rates	1/22/2014	1/30/2014	Satisfactorily Resolved
LA	FCC	Alonzo Allen	Inmate Complaint	High Rates	1/22/2014	2/3/2014	Satisfactorily Resolved
CA	FCC	Maureen Sweeney	858-373-XXXX	DAK	1/22/2014	2/3/2014	Satisfactorily Resolved
CA	FCC	Selena Brewer	662-345-XXXX	RCF (Call diversion)	1/22/2014	2/4/2014	Satisfactorily Resolved
AL	FCC	Terrance Peacock	334-588-XXXX	High Rates	1/29/2014	2/10/2014	Satisfactorily Resolved
IL	AGO	Lashawn Hemdon	Inmate Complaint	Payment Posting Delay	2/7/2014	2/18/2014	Satisfactorily Resolved
CA	FCC	Robert Fiore	951-395-XXXX	Pay Now	2/12/2014	2/18/2014	Satisfactorily Resolved
MD	FCC	Torina Collis	240-508-XXXX	Billing Dispute	2/19/2014	2/12/2014	Satisfactorily Resolved
OH	DOA	Darrin Harris	419-524-XXXX	DAK/LEC	2/19/2014	2/28/2014	Satisfactorily Resolved

AL	FCC	Cindy Carlen	334-369-XXXX	Billing Dispute	2/26/2014	3/6/2014	Satisfactorily Resolved
FL	FCC	Gisela Salerno	786-601-XXXX	High Rates	3/5/2014	3/21/2014	Satisfactorily Resolved
KY	FCC	Bratcher	Inmate Compliant	High Rates	3/12/2014	4/2/2014	Satisfactorily Resolved
GA	FCC	Claudia Davis	770-482-XXXX	Billing Dispute	3/12/2014	3/24/2014	Satisfactorily Resolved
NC	PUC	Dorothy W Shanklin	XXXX	Automated Calls	3/17/2014	3/19/2014	Satisfactorily Resolved
AL	FCC	Earl Rief	256-632-XXXX	Billing Dispute/Account Inquiry	3/19/2014	3/26/2014	Satisfactorily Resolved
CT	FCC	Jerome Carriaso	(646) 827-XXXX	rate change)	3/19/2014	4/9/2014	Satisfactorily Resolved
TX	FCC	Bonnie Sweet	#1327814	Billing Dispute	3/19/2014	4/17/2014	Satisfactorily Resolved
MO	AGO	William Goodman	417-714-XXXX	account using company website .	3/25/2014	3/28/2014	Satisfactorily Resolved
AK	PUC	Don McDonald	Inmate Compliant	rate change)	3/25/2014	4/9/2014	Satisfactorily Resolved
FL	FCC	Carol Stuart	XXXX	Transaction Fees	3/26/2014	4/1/2014	Satisfactorily Resolved
MO	FCC	Gail Dees	(636) 789-2349	rate change)	3/26/2014	3/31/2014	Satisfactorily Resolved
TX	FCC	Adrian Estrada	#1707518	rate change)	3/26/2014	4/8/2014	Satisfactorily Resolved
TX	FCC	Freesia Denton	903-887-XXXX	Payment Posting Delay	3/26/2014	4/28/2014	Satisfactorily Resolved
NY	FCC	Ronald Gans	212-957-XXXX	rate change)	3/26/2014	4/25/2014	Satisfactorily Resolved
CO	FCC	Sharalynn Rodha	303-759-XXXX	CNGC	3/26/2014	4/28/2014	Satisfactorily Resolved
MI	FCC	Helen Garcia	(inmate)	rate change)	3/26/2014	4/29/2014	Satisfactorily Resolved
MN	FCC	Anita Carrihers	763-228-XXXX	Billing Dispute	3/26/2014	5/2/2014	Satisfactorily Resolved
KY	FCC	Patricia Thomas	513-349-XXXX	Billing Dispute/Inmate Debit Acct	4/4/2014	5/6/2014	Satisfactorily Resolved
AK	PSC	Jack Ibach	Inmate Compliant	CNGC/LEC Billing Eliminated	4/4/2014	4/15/2014	Satisfactorily Resolved
AR	PSC	Michael Pierce	(602) 464-XXXX	Billing Dispute/Rate Inquiry	4/4/2014	4/15/2014	Satisfactorily Resolved
VT	AGO	Janet M. O'Bryan	413-441-XXXX	Fraudulent Charges	4/9/2014	Pending	Satisfactorily Resolved
LA	PSC	Janet Crouse	(225) 929-XXXX	High Rates/Rate Inquiry	4/8/2014	4/16/2014	Satisfactorily Resolved
LA	PSC	Susan Burch	(225) 721-XXXX	High Rates/Rate Inquiry	4/8/2014	4/16/2014	Satisfactorily Resolved
LA	PSC	Charles H. Parker	Inmate Compliant	Rate Inquiry/Pay Now calls	4/9/2014	4/21/2014	Satisfactorily Resolved
WA	FCC	Diane Cristelli Webb	206-617-XXXX	Payment Issue	4/9/2014	5/14/2014	Satisfactorily Resolved
TX	FCC	Gerald Hochmecht #519312	Inmate Compliant	High Rates (FCC Y Collection Calls	4/9/2014	5/14/2014	Satisfactorily Resolved
CT	FCC	Melissa Syvain	203-873-XXXX	High Rates (FCC)	4/9/2014	5/8/2014	Satisfactorily Resolved
WA	AGO	Clinton E Shell	Inmate Compliant	RCF/CNGC	4/15/2014	4/22/2014	Satisfactorily Resolved
FL	FCC	Johanne Madsen	XXXX	Dropped calls/Premature Disconnect	4/23/2014	5/19/2014	Satisfactorily Resolved
TX	FCC	Cedric Pruitt	Inmate Compliant	High Rates	4/23/2014	5/16/2014	Satisfactorily Resolved
MT	PSC	Rona Witt	(406) 452-XXXX	Unable to reach a representative	4/23/2014	4/23/2014	Satisfactorily Resolved
NY	AGO	Susan West	515-991-XXXX	DAK/ Fraudulent Charges	4/25/2014	4/30/2014	Satisfactorily Resolved
OH	AGO	Alberta Bell	937-270-XXXX	Dropped Calls	4/27/2014	5/5/2014	Satisfactorily Resolved
AK	PSC	Marjorie Shorthill	907-696-XXXX	High Rates	4/30/2014	5/13/2014	Satisfactorily Resolved
NM	PSC	Jacob Zuniga	505-402-XXXX	High Rates	4/30/2014	5/5/2014	Satisfactorily Resolved
MI	FCC	Katherine Burdett	269-987-XXXX	High Rates (FCC)/Disconnected Calls	4/30/2014	5/22/2014	Satisfactorily Resolved
CA	FCC	Martin Ozolins	760-405-XXXX	Automated Calls	4/30/2014	5/21/2014	Satisfactorily Resolved
IL	PSC	James Barr	312-814-XXXX	CNGC	5/5/2014	5/20/2014	Satisfactorily Resolved
TX	FCC	Mike Burrington	815-864-XXXX	High Rates (FCC)	5/7/2014	6/13/2014	Satisfactorily Resolved
IL	FCC	Jacqueline Brewer	Inmate Compliant	Rate Inquiry	5/7/2014	6/13/2014	Satisfactorily Resolved
TX	FCC	Richard Jaxson	281-256-XXXX	High Rates (FCC)	5/7/2014	6/13/2014	Satisfactorily Resolved

AZ	FCC	James Gill	623-486-XXXX	Billing Issues	5/7/2014	6/13/2014	Satisfactorily Resolved
TX	FCC	Jason Laird	Inmate Compliant	High Rates (FCC)	5/7/2014	6/13/2014	Satisfactorily Resolved
CA	AGO	Ronald Lee	707-442-XXXX	PVP (LEC Block)	5/12/2014	6/12/2014	Satisfactorily Resolved
ND	AGO	Dawn Lende	650-XXXX (701)-652-	Unwanted Automated Calls	5/9/2014	5/29/2014	Satisfactorily Resolved
AK	FCC	Carl JR. Thompson	Inmate Compliant	High Rates (FCC)	5/16/2014	6/20/2014	Satisfactorily Resolved
TX	FCC	Sandra Sanders	XXXX	Payment Issues/ Automated Calls	5/16/2014	6/20/2014	Satisfactorily Resolved
MT	FCC	Stacey Gastia	406-933-XXXX	High Rates	5/16/2014	6/20/2014	Satisfactorily Resolved
TX	PUC	Judy Meur	972-752-XXXX	Billing Issues	5/29/2014	6/27/2014	Satisfactorily Resolved
FL	FCC	Jesse Cordon	954-674-XXXX	Drop ped Calls	6/30/2014	7/4/2014	Satisfactorily Resolved
PA	AGO	Robertia Lutz	570-363-XXXX	CNGC	an extension	6/10/2014	Satisfactorily Resolved
AK	PUC	Susan Bravo	(907) 339-XXXX	Denies All Knowledge (DAK)	6/3/2014	6/4/2014	Satisfactorily Resolved
MO	FCC	Dennis Banahan	417-275-XXXX	High Rates (FCC Rates)	6/16/2014	6/27/2014	Satisfactorily Resolved
FL	FCC	Malcolm Austin	352-216-XXXX	Voice Mail Greeting	6/2/2014	6/25/2014	Satisfactorily Resolved
TX	FCC	Bruce Harp Pld# 440816	610-XXXX	High Rates (FCC Rates)	6/19/2014	6/27/2014	Satisfactorily Resolved
FL	FCC	L.R./Linda Wright	727-546-XXXX	Drop ped Calls	6/11/2014	7/11/2014	Satisfactorily Resolved
KY	AGO	Sandra Vaughn	customer's# (659)-304-	Billing Dispute	N/A	6/20/2014	Satisfactorily Resolved
PA	AGO	Alicia Smith	717-701-XXXX	CNGC	6/11/2014	6/27/2014	Satisfactorily Resolved
PA	FCC	Alicia Smith	717-701-XXXX	CNGC	6/11/2014	6/27/2014	Satisfactorily Resolved
FL	FCC	Kendrick Candida	(863) 244-XXXX	Drop ped Calls	6/11/2014	7/2/2014	Satisfactorily Resolved
LA	PSC	Becky McRae	318-933-XXXX	Not LEC Bill able	6/11/2014	6/25/2014	Satisfactorily Resolved
IL	FCC	Inmate Montrell Holmes	XXXX(773)375-XXXX/	Billing Dispute	6/25/2014	7/11/2014	Satisfactorily Resolved
MI	FCC	Robert Naughton	517-294-XXXX	Billing Dispute	6/25/2014	7/17/2014	Satisfactorily Resolved
LA	PSC	Virginia Harris	318-925-XXXX	Billing Dispute	6/23/2014	7/16/2014	Satisfactorily Resolved
AZ	FCC	Lynn Moosbrugger	602-303-XXXX	CNGC	7/2/2014	7/22/2014	Satisfactorily Resolved
FL	FCC	Kelvin Doniztir	Inmate Compliant	High Rates	7/8/2014	7/8/2014	Satisfactorily Resolved
AZ	FCC	Andrea Charles	6) 233-XXXX (602) 579-XX	CNGC / RCF	7/9/2014	7/29/2014	Satisfactorily Resolved
PA	FCC	Carrisa Kepple	814-594-XXXX	CNGC	7/23/2014	8/7/2014	Satisfactorily Resolved
AK	FCC	Carl Dashman	809-939-XXXX	CNGC	7/23/2014	8/12/2014	Satisfactorily Resolved
FL	FCC	Victoria Bridgeman	407-572-XXXX	Billing Dispute/High Rates	7/23/2014	8/8/2014	Satisfactorily Resolved
CA	FCC	Celeste Dobbs	619-781-XXXX	Out of Calls	7/30/2014	8/14/2014	Satisfactorily Resolved
AK	FCC	Sherman Pitt	7) 224-XXXX (360) 592-XX	FCC High Rates/ Block Calls	7/30/2014	8/14/2014	Satisfactorily Resolved
IL	FCC	Shantayre Jeffroe	618-972-XXXX	Call Interruption's	7/30/2014	8/21/2014	Satisfactorily Resolved
VA	FCC	Natonya Lucas	757-277-XXXX	Billing Dispute/ Drop Call	7/30/2014	8/19/2014	Satisfactorily Resolved
WI	FCC	Angela Williams	4) 458-XXXX (815) 802-XX	FCC High Rates	7/30/2014	8/25/2014	Satisfactorily Resolved
TX	FCC	Jason Laird	Inmate Compliant	FCC High Rates	7/30/2014	8/22/2014	Satisfactorily Resolved
TX	FCC	Mark Johnson	Inmate Compliant	FCC High Rates	7/30/2014	8/15/2014	Satisfactorily Resolved
TX	FCC	Susan Scheeler	2) 215-XXXX (682) 224-XX	Billing Dispute	7/30/2014	8/22/2014	Satisfactorily Resolved
TN	FCC	Jim Fowler	3) 991- XXXX (423) 332-XX	RCF Block	7/30/2014	9/5/2014	Satisfactorily Resolved
CO	FCC	Sharon Dorcas	720-360-XXXX	Video Visitation	8/6/2014	9/15/2014	Satisfactorily Resolved
TN	FCC	Elizabeth Malone	XXXX	Billing Dispute	8/6/2014	8/27/2014	Satisfactorily Resolved
WI	FCC	Angela Williams	(414) 458-8618	FCC High Rates	8/6/2014	8/26/2014	Satisfactorily Resolved
MO	FCC	Inmate James Geitz #59286	Inmate Compla int#59286	FCC High Rates	8/6/2014	8/28/2014	Satisfactorily Resolved

TX	FCC	Deyvn Collins	6) 371-XXXX_(996) 371-XX	FCC High Rates	8/13/2014	9/11/2014	Satisfactorily Resolved
MI	FCC	Rickie Hill	816-399-XXXX	FCC High Rates	8/13/2014	9/4/2014	Satisfactorily Resolved
LA	FCC	Sandra Humphries	318-249-XXXX	LEC Billing Not Allowed	8/13/2014	9/2/2014	Satisfactorily Resolved
FL	FCC	Erin Garrett	850-777-XXXX	FCC High Rates	8/13/2014	9/12/2014	Satisfactorily Resolved
FL	FCC	Julio Martinez	Inmate Complaint #053602	FCC High Rates	8/13/2014	9/17/2014	Satisfactorily Resolved
TX	FCC	Zerick Waites	214-995-XXXX	Update Account Information	8/13/2014	9/16/2014	Satisfactorily Resolved
AL	FCC	Tracy Stokes	850-390-XXXX	Dropped Calls	8/20/2014	9/22/2014	Satisfactorily Resolved
TX	FCC	Sonia Hernandez	512-653-XXXX	Billing Dispute	8/20/2014	10/2/2014	Satisfactorily Resolved
FL	FCC	Richard Colosky	561-860-XXXX	Out of Calls (cell phone)	8/21/2014	9/22/2014	Satisfactorily Resolved
MI	FCC	Alahndia McGinnis	989-817-XXXX	FCC High Rates	9/10/2014	10/3/2014	Satisfactorily Resolved
FL	FCC	George Dorman	850-465-XXXX	Billing Dispute	9/17/2014	10/16/2014	Satisfactorily Resolved
CO	FCC	Jason Runyan	303-815-XXXX	Securus Video Visitation Blocked	9/17/2014	10/7/2014	Satisfactorily Resolved
NC	FCC	Justin Wilson	XXXX	RCF Jail Call Services	9/17/2014	10/8/2014	Satisfactorily Resolved
TX	FCC	Syble Gallo	727-383-XXXX	Billing Dispute	9/17/2014	10/6/2014	Satisfactorily Resolved
UT	FCC	Loni Radmail	801-694-XXXX	Securus Video Visitation Blocked	9/18/2014	10/24/2014	Satisfactorily Resolved
CA	FCC	Melissa Estus	510-507-XXXX	RCF Jail Call Services	9/18/2014	10/13/2014	Satisfactorily Resolved
OK	FCC	Agnies Zornes	5) 592-XXXX/(405) 592-XX	RCF Inmate Aid	9/18/2014	10/10/2014	Satisfactorily Resolved
AL	FCC	Pala Slayton	205-594-XXXX	RCF ("RCF")	9/18/2014	10/21/2014	Satisfactorily Resolved
TN	FCC	Jim Fowler	3) 991-XXXX (423) 332-XX	RCF Block	9/19/2014	9/22/2014	Satisfactorily Resolved
TX	FCC	Jennifer Leonardi	423-388-XXXX	FCC High Rates	9/24/2014	10/28/2014	Satisfactorily Resolved
LA	FCC	Mary Humphries	318-396-XXXX	CNG/LEC billing Discontinued	10/1/2014	10/29/2014	Satisfactorily Resolved
MO	FCC	Pam Gretza	630-295-XXXX	Out Of Calls	10/1/2014	10/22/2014	Satisfactorily Resolved
CO	FCC	Jamie Crystal	XXX (503) 349-XXXX, (303	CNG/ Payment Block	10/9/2014	11/5/2014	Satisfactorily Resolved
SC	FCC	Edward Oliver	Inmate Complaint	High Rates	10/15/2014	11/10/2014	Satisfactorily Resolved
MI	FCC	Jayelynn White	313-231-XXXX	High Rates	10/15/2014	11/11/2014	Satisfactorily Resolved
OR	FCC	Payson Young	503-754-XXXX	High Rates	10/29/2014	11/25/2014	Satisfactorily Resolved
IL	FCC	Aureliuse Piper	Inmate Complaint (399831)	High Rates	10/29/2014	11/19/2014	Satisfactorily Resolved
PA	AGO	Roberta Lutz	570-363-XXXX	CNGC	6/3/2014	6/10/2014	Satisfactorily Resolved
KY	AGO	Sandra Vaughn	customer # (859)-304-	Billing Dispute	6/11/2014	6/20/2014	Satisfactorily Resolved
PA	AGO	Alicia Smith	717-701-XXXX	CNGC	6/11/2014	6/27/2014	Satisfactorily Resolved
AR	PSC	Susan Bravo	(907) 339-XXXX	Denies All Knowledge (DAK)	6/2/2014	6/4/2014	Satisfactorily Resolved
MO	AGO	Bill White	XXXX	CNGC	7/10/2014	7/24/2014	Satisfactorily Resolved
IL	AGO	Lisa	812-499-XXXX	Solicitation Calls	7/11/2014	8/1/2014	Satisfactorily Resolved
CA	AGO	Terri M. Robinson	951-242-XXXX	CNGC	7/21/2014	8/6/2014	Satisfactorily Resolved
MI	AGO	Trudy Jackson	989-932-XXXX	No Third Party Calls Allowed	7/25/2014	8/4/2014	Satisfactorily Resolved
LA	AGO	Faye Hill	318-933-XXXX	CNGC	7/16/2014	8/6/2014	Satisfactorily Resolved
IL	AGO	Gary Kraulides	(773) 767-XXXX	Automated Calls	7/29/2014	8/5/2014	Satisfactorily Resolved
LA	AGO	Ruby Graham	318-925-XXXX	CNGC	7/29/2014	7/29/2014	Satisfactorily Resolved
IN	AGO	Cheryl L Byrnes	812-476-XXXX	Automated Calls	8/6/2014	8/20/2014	Satisfactorily Resolved
OH	AGO	Cinda Boucher	614-260-XXXX	CNGC-Jail Call Services	8/18/2014	8/20/2014	Satisfactorily Resolved
FL	PSC	Kimberly Brooks	941-879-XXXX	Payment not Posted	8/1/2014	8/12/2014	Satisfactorily Resolved
AK	PSC	Thomas Piper	907-278-XXXX	CNGC	8/22/2014	8/22/2014	Satisfactorily Resolved

IL	AGO	Barbara/ Solomon Davis	773-378-XXXX	Customer is not Getting Calls	9/10/2014	9/17/2014	Satisfactorily Resolved
IL	AGO	Terry Barker	Inmate Compliant	High Rates	9/15/2014	9/24/2014	Satisfactorily Resolved
IL	AGO	Sandy Williams	Inmate Compliant	High Rates /Cut Of Calls	9/18/2014	10/1/2014	Satisfactorily Resolved
IL	AGO	Marion Singleton	Inmate Compliant	High Rates	9/18/2014	9/26/2014	Satisfactorily Resolved
IL	AGO	Donald Quickle	Inmate Compliant	High Rates	9/18/2014	9/29/2014	Satisfactorily Resolved
IL	PUC	Pamela Gretza	630-776-XXXX	Cut Off Calls	9/15/2014	9/25/2014	Satisfactorily Resolved
FL	PUC	William Khol	239-461-XXXX	Unwanted Automated Calls	9/29/2014	10/1/2014	Satisfactorily Resolved
AK	PUC	Marjorie Sacchreus	907-890-XXXX	Billing Dispute	9/29/2014	10/1/2014	Satisfactorily Resolved
CO	AGO	Rebecca Pickett	740-591-XXXX	High Rates	10/3/2014	10/9/2014	Satisfactorily Resolved
AR	AGO	Nikki Wornack	479-445-XXXX	Automated Calls	10/13/2014	10/14/2014	Satisfactorily Resolved
IL	AGO	Rosetta Holmes	(773) 933-9768	Billing Dispute	10/15/2014	10/20/2014	Satisfactorily Resolved
WA	PSC	Terrance Sullivan	206-824-XXXX	High Rates	10/27/2014	11/3/2014	Satisfactorily Resolved
IN	PSC	George Hewitt	574-333-XXXX	Automated Calls	10/24/2014	10/28/2014	Satisfactorily Resolved
MN	AGO	Evelyn Walker	651-340-XXXX	Payment not Posted	11/3/2014	11/5/2014	Satisfactorily Resolved
TX	FCC	Janice Bailey	972-576-XXXX	Payment Issue	11/10/2014	12/8/2014	Satisfactorily Resolved
IL	AGO	Herman Addison	ate Herman Addison # B85	Billing Issues	11/26/2014	12/8/2014	Satisfactorily Resolved
TN	FCC	Inmate F.E. Harris Jr.	Inmate F.E. Harris # 216256	Lec Billing Changes	12/3/2014	12/23/2014	Satisfactorily Resolved
KY	AGO	Carl Casey	502-487-XXXX	Payment Issues/	12/4/2014	1/23/2015	Satisfactorily Resolved
IL	PSC	Bridget Talmer-Cook	773-699-XXXX	CNGC	12/9/2014	12/10/2014	Satisfactorily Resolved
MN	AGO	Frances Juker	612-226-XXXX	Unwanted Calls	12/10/2014	12/10/2014	Satisfactorily Resolved
VA	FCC	Eboni Carmon	804-447-XXXX	High Rates	12/10/2014	12/16/2014	Satisfactorily Resolved
MN	AGO	Cheryl Kalliszewski	651-774-XXXX	CNGC	12/15/2014	12/22/2014	Satisfactorily Resolved
TX	FCC	Jean Thomas on behalf of William Bec	713-501-XXXX	Billing Issues	12/16/2014	12/24/2014	Satisfactorily Resolved
IL	AGO	Juanita Woodard	773-233-XXXX	Lec Billing Changes	12/19/2014	12/29/2014	Satisfactorily Resolved
GA	FCC	Shelliah Eakin	229-246-XXXX	High Rates	1/5/2015	1/15/2015	Satisfactorily Resolved
TX	FCC	Sheryl Brown	469-573-XXXX	Blocked/RCF	1/4/2015	2/13/2015	Satisfactorily Resolved
OH	FCC	Tina Azolino	602-892-XXXX	Blocked/RCF	1/26/2015	2/20/2015	Satisfactorily Resolved
WI	PSC	Vallie Kaprelian	920-450-XXXX	Account Status	1/26/2015	2/9/2015	Satisfactorily Resolved
MI	PSC	William Darling	616-456-XXXX	High Rates	1/13/2015	1/23/2015	Satisfactorily Resolved
AZ	FCC	Ronald Gans	212-957-XXXX	High Rates	1/27/2015	2/24/2015	Satisfactorily Resolved
NE	FCC	Terrie Thawke	402-278-XXXX	High Rates	2/5/2015	3/11/2015	Satisfactorily Resolved
	AGO	Mark Moriarity	969-254-XXXX	Billing Dispute	2/5/2015	3/4/2015	Satisfactorily Resolved
MI	FCC	Kathryn Montgomery	13-401-XXXX/943-451-XXX	High Rates	2/5/2015	3/4/2015	Satisfactorily Resolved
CO	FCC	Brandon Prestwich	801-205-XXXX	Billing Dispute	2/10/2015	3/6/2015	Satisfactorily Resolved
OH	FCC	Michael Crossno	67-550-XXXX/941-388-XXX	CNGC	2/13/2015	3/13/2015	Satisfactorily Resolved
NC	FCC	Maria Madison	828-280-XXXX	RCF	2/11/2015	3/13/2015	Satisfactorily Resolved
IL	FCC	Elizabeth Cox	630-607-XXXX	High Rates	2/18/2015	3/18/2015	Satisfactorily Resolved
PA	FCC	Andrew Boyd	814-621-XXXX	System Issue	2/18/2015	3/17/2015	Satisfactorily Resolved
MO	AGO	Linda S. Ehlen	314-803-XXXX	CNGC	2/19/2015	3/11/2015	Satisfactorily Resolved
PA	FCC	Claudia Tramer	022-349-XXXX	High Rates	3/1/2015	3/26/2015	Satisfactorily Resolved
WA	AGO	Shirley Ann Bogg s	29-322-XXXX/229-322-XXX	Billing Dispute	3/3/2015	3/19/2015	Satisfactorily Resolved
AZ	FCC	Betty Perkins	02-892-XXXX/520-777-XXX	RCF	3/3/2015	3/25/2015	Satisfactorily Resolved

IL	PSC	Betty Wilson	917-837-XXXX	CNGC/180 Day Policy	3/4/2015	3/11/2015	Satisfactorily Resolved
WI	PSC	Gary Graham	715-232-XXXX	Automated Calls/Pay	3/4/2015	3/18/2015	Satisfactorily Resolved
AK	PSC	Inmate Jason Pirle	Inmate Compliant	CNGC/Billing Issues	3/6/2015	3/16/2015	Satisfactorily Resolved
GA	FCC	Shirley Poole	29-322-XXXX/ 229-322-XXXX	High Rates	3/9/2015	3/16/2015	Satisfactorily Resolved
OK	PSC	Kathy Mills	918-833-XXXX	High Rates	3/10/2015	3/23/2015	Satisfactorily Resolved
MI	FCC	Richard Meyer	989-275-XXXX	Billing / Customer Not Getting Calls	3/11/2015	4/7/2015	Satisfactorily Resolved
IL	FCC	Betty Larsha	773-963-XXXX	Unable to reach a representative	3/16/2015	4/8/2015	Satisfactorily Resolved
PA	AGO	Betty Lane	412-363-XXXX	Payment Issue	3/19/2015	4/9/2015	Satisfactorily Resolved
WI	AGO	Valda Payette	920-897-XXXX	CNGC/ Lec Billing Not Allowed	3/19/2015	4/2/2015	Satisfactorily Resolved
VA	FCC	Vicki Rose	804-371-XXXX	High Rates	3/19/2015	4/7/2015	Satisfactorily Resolved
MI	FCC	Sarah Ferguson	248-293-XXXX	High Rates	3/23/2015	4/13/2015	Satisfactorily Resolved
MN	FCC	Tyler Tiegs	715-419-XXXX	High Rates	3/24/2015	4/23/2015	Satisfactorily Resolved
FL	FCC	James Loftus	813-498-XXXX	Pay Now	4/1/2015	4/21/2015	Satisfactorily Resolved
OH	AGO	Juliana Crawford Aburahmeh	937-496-XXXX	Payment Issue	4/1/2015	4/14/2015	Satisfactorily Resolved
KY	FCC	Malcolm Froome	615-785-XXXX	Pay Now	4/3/2015	4/22/2015	Satisfactorily Resolved
LA	PSC	Lee A. Brown	318-635-XXXX	Lec Not Billable	4/8/2015	4/17/2015	Satisfactorily Resolved
IL	AGO	Inmate Eddie Adams	Inmate Compliant	Payment Issues	4/13/2015	4/17/2015	Satisfactorily Resolved
IL	AGO	Inmate George Mack	Inmate Compliant	Cut of Calls	4/15/2015	4/21/2015	Satisfactorily Resolved
MN	FCC	Erin Meleen	612-791-XXXX	High Rates	4/15/2015	5/28/2015	Satisfactorily Resolved
LA	PSC	Paul LaCombe	318-665-XXXX	Refund Issues	4/21/2015	4/22/2015	Satisfactorily Resolved
TN	FCC	Gary Action	901-674-XXXX	Inability to Talk to a Rep	4/22/2015	5/6/2015	Satisfactorily Resolved
TX	FCC	Laura Rodriguez	281-650-XXXX	High Rates	4/23/2015	4/28/2015	Satisfactorily Resolved
WI	PSC	Christopher Yoops	414-541-XXXX	Payment Issues	4/23/2015	4/28/2015	Satisfactorily Resolved
LA	FCC	Colin Pipkins	504-881-XXXX	High Rates	4/23/2015	5/12/2015	Satisfactorily Resolved
WI	PSC	Inmate Darryl Deramus	Inmate Compliant	Payment Issue	4/27/2015	4/30/2015	Satisfactorily Resolved
WI	PSC	Wayne D. Murphy	Inmate Compliant	High Rates	4/27/2015	5/13/2015	Satisfactorily Resolved
WI	PSC	Donley Mc Intosh	Inmate Compliant	High Rates	4/29/2015	5/14/2015	Satisfactorily Resolved
FL	FCC	Julio Martinez	305-773-XXXX	High Rates	4/30/2015	5/18/2015	Satisfactorily Resolved
TX	FCC	Elizabeth Ozejo	210-394-XXXX	Payment Time	4/30/2015	5/19/2015	Satisfactorily Resolved
TX	FCC	Tabatha Perry	972-279-XXXX	Account/Billing Conversion	5/1/2015	5/27/2015	Satisfactorily Resolved
TX	FCC	Kathy Burkett	936-441-XXXX	High Rates #Inability to Talk to Rep	5/1/2015	5/21/2015	Satisfactorily Resolved
SC	FCC	Brandi Johnson	843-325-XXXX	High Rates	5/4/2015	6/4/2015	Satisfactorily Resolved
TX	FCC	Martha Chapman	956-472-XXXX	High Rates	5/4/2015	5/26/2015	Satisfactorily Resolved
AL	FCC	Robert Hirt	404-514-XXXX	High Rates #Inability to Talk to Rep	5/13/2015	6/10/2015	Satisfactorily Resolved
SC	FCC	Inmate Ralph Roman-GP5705	Inmate Compliant	Call Quality	5/13/2015	6/4/2015	Satisfactorily Resolved
AZ	FCC	Glennaris Carter	480-896-XXXX	180 Day Policy	5/20/2015	6/12/2015	Satisfactorily Resolved
ND	AGO	Bobbi Milbrath	701-228-XXXX	Unwanted Inmate Calls	5/22/2015	5/22/2015	Satisfactorily Resolved
MN	AGO	Mark Olson/ Tammy Wittmer	763-762-XXXX	Dropped Calls	5/27/2015	5/28/2015	Satisfactorily Resolved
NM	FCC	Teresa Ouchley	915-274-XXXX	High Rates	5/27/2015	6/17/2015	Satisfactorily Resolved
LA	AGO	Leonard Cosby	318-371-XXXX	Account/Billing Conversion	5/28/2015	6/12/2015	Satisfactorily Resolved
TX	FCC	Terry McNiel	512-658-XXXX	Cut off Call	6/2/2015	6/19/2015	Satisfactorily Resolved
AK	PSC	Vlad a Sotakaya	907-929-XXXX	Account Information	6/4/2015	6/4/2015	Satisfactorily Resolved

OH	AGO	Barbara Parker	40-262-XXXX/740-387-XXX	High Rates	6/4/2015	6/19/2015	Satisfactorily Resolved
FL	PSC	Ed Bowell	21-946-XXXX/386-589-XXX	Payment Issue	6/5/2015	6/8/2015	Satisfactorily Resolved
NJ	FCC	Danielle Kizczkowski	973-803-XXXX	Billing Issues	6/8/2015	6/22/2015	Satisfactorily Resolved
AZ	FCC	Theresa Elliot	928-580-XXXX	Billing Issues	6/11/2015	6/25/2015	Satisfactorily Resolved
TX	FCC	Loyde Williams	817-703-XXXX	Billing Issues	6/11/2015	6/30/2015	Satisfactorily Resolved
NV	PSC	Evelyn Johnson	907-747-XXXX	CNGC (CNGC)	6/16/2015	6/17/2015	Satisfactorily Resolved
AK	FCC	Marcia S. Kosterka	702-270-XXXX	Payment Issue	6/16/2015	6/30/2015	Satisfactorily Resolved
IL	AGO	William A. Becker	618-317-XXXX	Unwanted Calls	6/17/2015	6/18/2015	Satisfactorily Resolved
NC	PSC	Donna Homer	336-221-XXXX	stant Pay/Now/Text2Connect/FC	6/17/2015	6/22/2015	Satisfactorily Resolved
IL	AGO	Inmate Andre G. Jones #R22158	Inmate Compliant	Cut Off Calls (COC) - Cellular	6/18/2015	6/18/2015	Satisfactorily Resolved
IL	PSC	Ina Schaffter	847-432-XXXX	Cut Off Calls (COC) - Cellular	6/22/2015	7/1/2015	Satisfactorily Resolved
FL	FCC	Beverly Irvin	440-356-XXXX	Billing Issues	6/22/2015	9/24/2015	Satisfactorily Resolved
CA	FCC	Virginia McCall	714-846-XXXX	Billing Issues	6/23/2015	7/10/2015	Satisfactorily Resolved
LA	FCC	Michelle Martin	480-206-XXXX	CNGC	6/24/2015	7/10/2015	Satisfactorily Resolved
NJ	FCC	Mike Andrejko	732-349-XXXX	Payment Issue	6/29/2015	6/30/2015	Satisfactorily Resolved
PA	FCC	Oscar Various Hs-3136	Inmate Compliant	Call Quality	7/1/2015	7/14/2015	Satisfactorily Resolved
AK	PSC	Anuska Hanson	907-596-XXXX	Payment Not Posted	7/7/2015	7/13/2015	Satisfactorily Resolved
NC	FCC	DAWN PAFFENROTH	919-471-XXXX	High Rates	7/7/2015	7/30/2015	Satisfactorily Resolved
TX	FCC	Cynthia R. Welis	214-738-XXXX	Billing Issues	7/7/2015	8/5/2015	Satisfactorily Resolved
IL	AGO	Eugene Jackson	217-725-XXXX	CNGC	7/15/2015	7/16/2015	Satisfactorily Resolved
GA	FCC	Lindsay Snipes	706-350-XXXX	RCF	7/15/2015	8/10/2015	Satisfactorily Resolved
IL	AGO	Inmate Juan Padilla# N10785	Inmate Compliant	Payment Issues	7/17/2015	7/20/2015	Satisfactorily Resolved
IL	AGO	Inmate Octavius House#M03724	Inmate Compliant	Cut Off Calls	7/17/2015	7/21/2015	Satisfactorily Resolved
AK	PSC	Rita Thompson	907-561-XXXX	Billing Issues	7/17/2015	7/21/2015	Satisfactorily Resolved
IL	FCC	Toni Shumate	708-724-XXXX	CNGC (CNGC)	7/17/2015	7/27/2015	Satisfactorily Resolved
FL	FCC	Glenn Stuart	407-403-XXXX	Payment Not Posted	7/17/2015	8/7/2015	Satisfactorily Resolved
NM	FCC	Sandra Cates	575-487-XXXX	No Positive Acceptance	7/17/2015	8/11/2015	Satisfactorily Resolved
CA	FCC	Melissa Estus	510-507-XXXX	High Rates	7/22/2015	8/17/2015	Satisfactorily Resolved
WI	AGO	Bertie R. Butler	217-235-XXXX	Billing Issues	7/23/2015	7/24/2015	Satisfactorily Resolved
LA	PSC	Dorothy Liesmann	318-861-XXXX	Inquiry	7/24/2015	7/29/2015	Satisfactorily Resolved
GA	FCC	John Abercrombie	423-400-XXXX	High Rates	7/28/2015	8/24/2015	Satisfactorily Resolved
VA	PSC	Lisa Griffith	275-591-XXXX	Cut Off Calls	8/11/2015	8/12/2015	Satisfactorily Resolved
TX	FCC	Debra Newton	979-595-XXXX	Cut Off Calls	8/13/2015	9/3/2015	Satisfactorily Resolved
IL	FCC	Ruben Aguilar III	361-800-XXXX	High Rates	8/14/2015	8/31/2015	Satisfactorily Resolved
SC	FCC	Yvonne Richards	864-556-XXXX	High Rates	8/19/2015	9/9/2015	Satisfactorily Resolved
OR	FCC	Tim McKnight	503-863-XXXX	High Rates	8/21/2015	9/14/2015	Satisfactorily Resolved
VT	AGO	Robert Lierle	802-275-XXXX	SVV Credit/ Payment Issue	8/21/2015	9/16/2015	Satisfactorily Resolved
NC	PSC	Monica L. Brown	267-884-XXXX	Fraudulent Charges	8/24/2015	8/26/2015	Satisfactorily Resolved
OH	PSC	Eleanor Keenum	440-238-XXXX	Inability to Talk to a Rep	8/25/2015	9/1/2015	Satisfactorily Resolved
AK	AGO	Sara Mach	541-744-XXXX	RCF	8/28/2015	9/23/2015	Satisfactorily Resolved
IL	AGO	David Summers	217-316-XXXX	Payment/Funding Fees	8/31/2015	9/16/2015	Satisfactorily Resolved
VA	FCC	Larry Levine/ Pamela Powell	540-212-XXXX	RCF	8/31/2015	9/21/2015	Satisfactorily Resolved

AK	PSC	Glenn Arnold	907-401-XXXX	Payment Issue	9/3/2015	9/3/2015	9/3/2015	Satisfactorily Resolved
AK	FCC	Don McDonald	360-652-XXXX	Account/Billing Conversion	9/4/2015	9/4/2015	9/15/2015	Satisfactorily Resolved
TX	FCC	Charlane Meyer	512-581-XXXX	High Rates	9/9/2015	9/9/2015	Pending	Satisfactorily Resolved
MD	FCC	Kelly Steffen	660-684-XXXX	No Positive Acceptance	9/15/2015	9/15/2015	9/15/2015	Satisfactorily Resolved
IL	FCC	Bessie Spencer	312-498-XXXX	Payment Issue	9/23/2015	9/23/2015	9/24/2015	Satisfactorily Resolved
AR	FCC	Gerrald Niles	Inmate Compliant	90 Day Inactivity	9/24/2015	9/24/2015	9/28/2015	Satisfactorily Resolved
IL	AGO	Barbara Matimore	217-491-XXXX	Billing Dispute/Fraud	9/24/2015	9/24/2015	9/25/2015	Satisfactorily Resolved
IL	AGO	Mary Ward	724-256-XXXX	Billing Dispute	9/30/2015	9/30/2015	9/30/2015	Satisfactorily Resolved
IL	AGO	Danielle Loyd	617-987-XXXX	CNGC	9/30/2015	9/30/2015	10/9/2015	Satisfactorily Resolved
OH	FCC	Inmate Brian A. Smith	Inmate Compliant	High Rates	9/30/2015	9/30/2015	10/19/2015	Satisfactorily Resolved
AK	FCC	Manfred West	Inmate Compliant	High Rates	9/30/2015	9/30/2015	10/16/2015	Satisfactorily Resolved
FL	FCC	Scott Schneider	727-417-XXXX	Billing Dispute	10/1/2015	10/1/2015	10/21/2015	Satisfactorily Resolved
TX	FCC	Deborah Cardenas	(210) 831-XXXX	Blocked	10/6/2015	10/6/2015	11/3/2015	Satisfactorily Resolved
AK	FCC	Sarah Ito, M.D.	(907) 586-XXXX	Billing Dispute	10/19/2015	10/19/2015	11/25/2015	Satisfactorily Resolved
TX	FCC	Rebecca Barnes	(832) 971-XXXX	High Rates	10/26/2015	10/26/2015	11/25/2015	Satisfactorily Resolved
MIN	FCC	Michelle Barry	(218) 671-XXXX	Pay Now	10/21/2015	10/21/2015	11/19/2015	Satisfactorily Resolved
FL	FCC	Inmate Otis Bixton	Inmate Compliant	Blocked	10/5/2015	10/5/2015	10/22/2015	Satisfactorily Resolved
AK	FCC	Diane Boyd	(907) 422-XXXX	High Rates	10/6/2015	10/6/2015	10/26/2015	Satisfactorily Resolved
IL	FCC	Inmate Taurean Giles	Inmate Compliant	Call Quality	10/14/2015	10/14/2015	11/4/2015	Satisfactorily Resolved
NM	FCC	Phyllis LaRue	(281) 463-XXXX	High Rates	10/23/2015	10/23/2015	11/20/2015	Satisfactorily Resolved
PA	FCC	Cathy Ludwig	(814) 893-XXXX	Remote Call Forwarding	10/6/2015	10/6/2015	10/23/2015	Satisfactorily Resolved
TX	FCC	Peter Mead	(541) 434-XXXX	Billing Dispute	10/14/2015	10/14/2015	11/12/2015	Satisfactorily Resolved
GA	FCC	David Miller	(903) 885-XXXX	High Rates	10/14/2015	10/14/2015	11/10/2015	Satisfactorily Resolved
CA	FCC	Rufus Nichols	(770) 483-XXXX	Pay Now	10/21/2015	10/21/2015	11/16/2015	Satisfactorily Resolved
MA	FCC	Mark Rain	(650) 363-XXXX	High Rates	10/21/2015	10/21/2015	11/16/2015	Satisfactorily Resolved
FL	FCC	Nicholas Reville	(508) 963-XXXX	Billing Dispute	10/23/2015	10/23/2015	11/23/2015	Satisfactorily Resolved
MO	FCC	Scott Schneider	(727) 417-XXXX	High Rates	10/1/2015	10/1/2015	10/21/2015	Satisfactorily Resolved
IL	FCC	Maureen Stewart	(708) 663-XXXX	Payment Issue	10/7/2015	10/7/2015	11/15/2015	Satisfactorily Resolved
PA	FCC	Inmate Tyree Tucker	Inmate Compliant	Call Quality	10/14/2015	10/14/2015	11/9/2015	Satisfactorily Resolved
CA	FCC	Inmate Charles Wade	Inmate Compliant	Account Status	9/21/2015	9/21/2015	10/14/2015	Satisfactorily Resolved
FL	FCC	Edward Wells	(215) 888-XXXX	Call Quality	10/28/2015	10/28/2015	11/25/2015	Satisfactorily Resolved
AR	AGO	Inmate Vernie Moore-Shabazz	Inmate Compliant	Payment Issue	8/23/2015	8/23/2015	10/19/2015	Satisfactorily Resolved
KY	AGO	Tommy Southard	(270) 765-XXXX	Refund Issue	10/6/2015	10/6/2015	11/5/2015	Satisfactorily Resolved
MO	AGO	Kenneth Burris	573-746-XXXX	Inability to Talk to a Rep	11/2/2015	11/2/2015	11/11/2015	Satisfactorily Resolved
IN	AGO	Riley Fleming	Inmate Compliant	Refund Issues	12/6/2015	12/6/2015	12/23/2015	Satisfactorily Resolved
IN	AGO	Kimberly Grant	317-682-XXXX	Automated Calls	12/10/15	12/10/15	12/21/2015	Satisfactorily Resolved
TX	FCC	Lisa Adewole Roberts	(512) 650-XXXX	High Rates	11/20/2015	11/20/2015	12/10/2015	Satisfactorily Resolved
TN	FCC	Sidney McElhaney	(731) 859-XXXX	Remote Call Forwarding	11/2/2015	11/2/2015	12/4/2015	Satisfactorily Resolved
FL	FCC	Inmate James Pautausos	(727) 847-XXXX	Premature Call Disconnections	11/9/2015	11/9/2015	12/7/2015	Satisfactorily Resolved
LA	FCC	Heike Preisendorfer	318-717-XXXX	Remote Call Forwarding	11/1/2015	11/1/2015	12/15/2015	Satisfactorily Resolved
CA	FCC	Robin Rain	(650) 291-XXXX	High Rates	11/16/2015	11/16/2015	12/9/2015	Satisfactorily Resolved
MI	FCC	Rachel Reese	(269) 859-XXXX	High Rates	11/16/2015	11/16/2015	12/4/2015	Satisfactorily Resolved

FL	FCC	Pamela Rowdon	(386) 788-XXXX	Automated Calls	11/3/2015	12/3/2015	Satisfactorily Resolved
AK	FCC	Inmate Carl Thompson Jr	Inmate Compliant	High Rates	11/2/2015	12/2/2015	Satisfactorily Resolved
PA	FCC	Kelly Miele	(570) 780-XXXX	Billing Dispute	1/8/2016	12/4/2015	Satisfactorily Resolved
TX	FCC	Mary Pavay	(512) 564-XXXX	High Rates	12/1/2015	12/15/2015	Satisfactorily Resolved
CT	FCC	Michael Walsh	(203) 260-XXXX	Billing Dispute	12/2/2015	12/17/2015	Satisfactorily Resolved
AK	FCC	Tina Whisler	(907) 745-XXXX	Automated Calls	12/7/2015	12/17/2015	Satisfactorily Resolved
MT	DOJ	Bert Pezzarosi	(406) 951-XXXX	Billing Dispute	10/28/2015	11/17/2015	Satisfactorily Resolved
AR	PSC	Suzanne Weece	(479) 651-XXXX	High Rates	11/5/2015	11/24/2015	Satisfactorily Resolved
OR	DOJ	Deanna L Duey	(503) 585-XXXX	Automated Calls	11/17/2015	12/9/2015	Satisfactorily Resolved
OR	DOJ	Rebecca Whelaine	(360) 910-9717	Refund Issues	11/21/2015	12/10/2015	Satisfactorily Resolved
IL	AGO	Inmate Timothy Lucas	Inmate Compliant	Billing Dispute	1/13/2016	2/17/2016	Satisfactorily Resolved
TX	AGO	Jeffrey Simmons	(503) 547-XXXX	Billing Dispute	2/11/2016	2/26/2016	Satisfactorily Resolved
IL	FCC	Elizabeth Pittman	(618) 334-XXXX	Blocked	12/29/2015	1/14/2016	Satisfactorily Resolved
PA	FCC	Inmate Greg Eldred	Inmate Compliant	High Rates	12/16/2015	1/7/2016	Satisfactorily Resolved
PA	FCC	Cesar Polito	Inmate Compliant	High Rates	12/21/2015	1/11/2016	Satisfactorily Resolved
AR	FCC	Mary Day	(920) 933-XXXX	High Rates	1/4/2016	1/28/2016	Satisfactorily Resolved
IL	FCC	Inmate Joseph Dole	Inmate Compliant	High Rates	12/31/2015	1/26/2016	Satisfactorily Resolved
IL	FCC	Marlene Fredrick	262-237-XXXX	Billing Dispute	1/26/2016	2/12/2016	Satisfactorily Resolved
TX	FCC	Jozesa Gorski	(860) 827-XXXX	Automated Calls	12/28/2015	1/13/2016	Satisfactorily Resolved
TX	FCC	Dawd Haymes	(972) 233-XXXX	High Rates	1/27/2016	2/23/2016	Satisfactorily Resolved
CT	FCC	Amanda Hickey	(203) 509-XXXX	High Rates	1/13/2016	2/4/2016	Satisfactorily Resolved
TX	FCC	Jordan Smith	(830) 214-XXXX	High Rates	1/13/2016	2/3/2016	Satisfactorily Resolved
TX	FCC	Carri Joseph	(214) 317-XXXX	Billing Dispute	1/27/2016	1/12/2016	Satisfactorily Resolved
IL	FCC	Inmate Dennis L. Martin	Inmate Compliant	High Rates	12/23/2015	1/8/2016	Satisfactorily Resolved
IL	FCC	Sara Murphy	(618) 751-XXXX	High Rates	1/22/2016	2/8/2016	Satisfactorily Resolved
TX	FCC	Lisa Rodriguez	(817) 366-XXXX	Billing Dispute	12/30/2015	1/15/2016	Satisfactorily Resolved
AL	FCC	Cynthia Slocum	(334) 514-XXXX	Premature Call Disconnections	1/26/2016	2/16/2016	Satisfactorily Resolved
TX	FCC	Shaneil Smith	(210) 986-XXXX	High Rates	1/8/2016	2/11/2016	Satisfactorily Resolved
TX	FCC	Elisa Torres	(903) 588-XXXX	High Rates	1/26/2016	2/15/2016	Satisfactorily Resolved
MT	FCC	Kristi Barden	(406) 850-0289	Account Status	2/2/2016	3/2/2016	Satisfactorily Resolved
IL	FCC	Inmate Robert Beard	Inmate Compliant	Billing Dispute	1/12/2016	2/2/2016	Satisfactorily Resolved
FL	FCC	Michael Hasden	(850) 673-XXXX	Automated Calls	2/3/2016	3/3/2016	Satisfactorily Resolved
MT	FCC	Susanne Kreidler	(406) 855-XXXX	High Rates	2/2/2016	3/3/2016	Satisfactorily Resolved
AR	FCC	Becca Phillips	(716) 361-XXXX	High Rates	2/4/2016	3/7/2016	Satisfactorily Resolved
AK	FCC	Charles Rollins	(907) 488-XXXX	Billing Dispute	2/2/2016	3/3/2016	Satisfactorily Resolved
TX	FCC	Tamara Scott	(713) 359-XXXX	Billing Dispute	2/2/2016	3/1/2016	Satisfactorily Resolved
NJ	FCC	Jennifer Suniel	(806) 203-XXXX	Pay Now	2/8/2016	3/10/2016	Satisfactorily Resolved
NH	FCC	Justin Wilcox	(405) 748-XXXX	High Rates	2/2/2016	3/3/2016	Satisfactorily Resolved
NM	PSC	Michelle Mees	(920) 254-XXXX	Automated Calls	2/9/2016	2/15/2016	Satisfactorily Resolved
NM	PSC	Susan Ruetern Prokuaki	(505) 988-XXXX	Automated Calls	2/1/2016	2/10/2016	Satisfactorily Resolved
AR	FCC	Becca Phillips	(479) 220-XXXX	High Rates	2/4/2016	3/7/2016	Satisfactorily Resolved
FL	FCC	Michael Hasden	850-673-XXXX	Unwanted Inmate Calls	2/3/2016	3/4/2016	Satisfactorily Resolved

OK	FCC	Larry Gray	918-351-XXXX	Fees: Wireless/Admin/Regulatory	2/28/2016	3/27/2016	Satisfactorily Resolved
NH	FCC	Justin Wilcox	405-748-0185	Fees #High Rates	2/2/2016	3/3/2016	Satisfactorily Resolved
AK	FCC	Charles Rollins	907-488-XXXX	Payment Not Posted	2/2/2016	3/3/2016	Satisfactorily Resolved
MT	FCC	Kristi Barden	855-822-XXXX	Rates	2/2/2016	3/3/2016	Satisfactorily Resolved
TX	FCC	Tamara Scott	972-794-XXXX	Issues #Refund Process	2/2/2016	3/3/2016	Satisfactorily Resolved
MT	FCC	Susanne Kreidler	406-855-XXXX	Blocked Accounts, #High Rates	2/2/2016	3/3/2016	Satisfactorily Resolved
WI	PSC	Michelle Mees	920-254-XXXX	Set Up	2/1/2016	2/15/2016	Satisfactorily Resolved
FL	FCC	Inmate Gerald Niles # 122280	Inmate Compliant	90 Day Inactivity Policy	2/1/2016	2/12/2016	Satisfactorily Resolved
TX	FCC	Jannelle Gallegos	210-489-XXXX	FCC Rate Change	3/3/2016	4/2/2016	Satisfactorily Resolved
MI	FCC	Samantha Ardelean	517-512-XXXX	High Rates	3/7/2016	4/6/2016	Satisfactorily Resolved
AK	PSC	Terrance Stern	907-222-XXXX	Billing Dispute	3/8/2016	3/24/2016	Satisfactorily Resolved
MI	FCC	EDDIE-MAY WARD	231-773-XXXX	Automated Calls	3/9/2016	4/8/2016	Satisfactorily Resolved
IL	FCC	Inmate Francisco Gonzalez	Inmate Compliant	Call Quality	3/14/2016	4/13/2016	Satisfactorily Resolved
TX	FCC	Tammy Matsche	903-388-XXXX	FCC Rate Change	3/15/2016	4/14/2016	Satisfactorily Resolved
WI	FCC	Darelen Gambel	N/A	High Rates	3/15/2016	4/14/2016	Satisfactorily Resolved
IL	FCC	Inmate Joseph Dole	N/A	90 Day Inactivity	3/16/2016	3/30/2016	Satisfactorily Resolved
MI	FCC	Patricia Lesko	734-734-XXXX	FCC Rate Change	3/16/2016	4/15/2016	Satisfactorily Resolved
PA	FCC	Inmate-Charles Smith	N/A	Automated Calls	3/16/2016	4/14/2016	Satisfactorily Resolved
IL	FCC	Inmate Robert Beard #R22516	N/A	Cut Off Calls	3/16/2016	3/30/2016	Satisfactorily Resolved
IN	FCC	Sky Collins	502-299-XXXX	FCC Rate Change	3/17/2016	4/16/2016	Satisfactorily Resolved
AR	FCC	Inmate Mariford West	Inmate Compliant	Customer Not Getting Calls	3/18/2016	4/17/2016	Satisfactorily Resolved
IL	FCC	Shaun Hubbard #B46211	N/A	Automated Calls	3/21/2016	4/20/2016	Satisfactorily Resolved
IL	FCC	Alex Negron	N/A	Automated Calls	3/21/2016	4/20/2016	Satisfactorily Resolved
AK	FCC	Louis Hastings	N/A	Billing Dispute	3/22/2016	3/29/2016	Satisfactorily Resolved
NJ	FCC	Bruce Lieberman	201-522-XXXX	Dropped Calls/ Pay Now Calls	3/22/2016	4/21/2016	Satisfactorily Resolved
CA	FCC	Mark Rain	650-349-XXXX	Payment Funding Fees	3/22/2016	4/15/2016	Satisfactorily Resolved
IL	FCC	Inmate Renaldo Matthews	Inmate Compliant	Account Set Up	3/23/2016	4/22/2016	Satisfactorily Resolved
VA	FCC	Melanie Allen Dees	385-205-XXXX	Cut of Calls	3/23/2016	4/22/2016	Satisfactorily Resolved
CA	FCC	Sabina Herrera	760-486-XXXX	FCC Rate Change	3/23/2016	4/23/2016	Satisfactorily Resolved
IL	FCC	Inmate Daron Smith 346216	Inmate Compliant	Automated Calls	3/24/2016	4/21/2016	Satisfactorily Resolved
OK	FCC	Linda Abitbol	918-378-XXXX	FCC Rate Change	3/28/2016	4/27/2016	Satisfactorily Resolved
AR	FCC	Elaine McCool	479-439-XXXX	FCC Rate Change	3/28/2016	4/27/2016	Satisfactorily Resolved
GA	FCC	Patricia Yancey	404-990-XXXX	FCC Rate Change	3/28/2016	4/27/2016	Satisfactorily Resolved
AZ	FCC	Marissa Andrada	520-350-XXXX	FCC Rate Change	3/28/2016	4/27/2016	Satisfactorily Resolved
OR	FCC	Joshua Callington	612-879-XXXX	Fees	3/30/2016	4/29/2016	Satisfactorily Resolved
KY	FCC	Inmate Christopher Hooper#189984	Inmate Compliant	FCC Rate Change	3/31/2016	4/28/2016	Satisfactorily Resolved
TX	FCC	Mariam Habib	281-599-XXXX	FCC Rate Change	3/31/2016	4/30/2016	Satisfactorily Resolved
AR	FCC	Marilyn Donigan	877-710-XXXX	FCC Rate Change	3/31/2016	4/30/2016	Satisfactorily Resolved
KY	FCC	Clyde Atkins/ Larry Levine	859-439-XXXX	Remote Call Forwarding	3/31/2016	5/3/2016	Satisfactorily Resolved
PA	FCC	Audrey Owensbury/ Larry Levine	234-200-3374	Remote Call Forwarding	3/31/2016	5/3/2016	Satisfactorily Resolved
PA	FCC	Amanda Dummer/ Larry Levine	630-701-6181	Remote Call Forwarding	3/31/2016	5/3/2016	Satisfactorily Resolved
PA	FCC	Bennisha Roundtree / Larry Levine	404-334-4135	Remote Call Forwarding	3/31/2016	5/3/2016	Satisfactorily Resolved

PA	FCC	Larry/Levine / Abony Person	319-774-5771	Remote Call Forwarding	3/31/2016	5/3/2016	Satisfactorily Resolved
PA	FCC	Larry Levine on behalf of Sheila Thompson	419-549-XXXX	Remote Call Forwarding	3/31/2016	5/3/2016	Satisfactorily Resolved
CT	AGO	Inmate John Williams	203-248-XXXX	Refund Issue	4/29/2016	5/6/2016	Satisfactorily Resolved
IL	FCC	Inmate Anthony Spaulding K-54932	Inmate Compliant	FCC Rate Change	4/4/2016	5/4/2016	Satisfactorily Resolved
AR	FCC	Gerald Niles/ Wilma Niles	501-318-XXXX	FCC Rate Change	4/4/2016	5/4/2016	Satisfactorily Resolved
TX	FCC	Gabriela Alcalá	956-330-XXXX	FCC Rate Change	4/4/2016	5/4/2016	Satisfactorily Resolved
TX	FCC	Michelle Phillips	N/A	Payment Funding Fees	4/4/2016	5/5/2016	Satisfactorily Resolved
KY	FCC	Inmate David Miller	Inmate Compliant	FCC Rate Change	4/5/2016	5/5/2016	Satisfactorily Resolved
TX	FCC	Inmate Tracy Hicks	Inmate Compliant	Refund Issue	4/6/2016	5/6/2016	Satisfactorily Resolved
TX	FCC	Janit Smith	254-835-XXXX	FCC Rate Change	4/6/2016	5/6/2016	Satisfactorily Resolved
AR	FCC	Elaine McCool	479-439-XXXX	Payment Funding Fees	3/8/2016	4/27/2016	Satisfactorily Resolved
TX	FCC	MariSol Martinez	512-938-XXXX	FCC Rate Change	4/8/2016	5/8/2016	Satisfactorily Resolved
GA	FCC	Diane Bethea	404-316-XXXX	Cut of Calls	4/8/2016	5/8/2016	Satisfactorily Resolved
TX	FCC	Felicia Sosa	409-767-XXXX	FCC Rate Change	4/8/2016	5/8/2016	Satisfactorily Resolved
IN	FCC	Jennifer Hamer	317-604-XXXX	FCC Rate Change	4/11/2016	5/11/2016	Satisfactorily Resolved
TX	FCC	Samantha Shuffield	936-566-XXXX	FCC Rate Change	5/25/2016	6/8/2016	Satisfactorily Resolved
IL	FCC	LeShawn Lundy	773-981-XXXX	Cut of Calls	4/14/2016	5/14/2016	Satisfactorily Resolved
IL	FCC	Marie Landrum	779-225-XXXX	Cut of Calls	4/18/2016	5/18/2016	Satisfactorily Resolved
LA	FCC	Lori Gross	504-864-XXXX	FCC Rate Change	4/18/2016	5/18/2016	Satisfactorily Resolved
FL	FCC	John Holliday	877-710-XXXX	Blocked Accounts	4/19/2019	5/19/2016	Satisfactorily Resolved
TX	FCC	Lindsay Guest	956-607-XXXX	FCC Rate Change	4/19/2019	5/19/2016	Satisfactorily Resolved
TX	FCC	Robin Malone	806-350-XXXX	FCC Rate Change	4/20/2016	5/20/2016	Satisfactorily Resolved
IL	FCC	Inmate Leonard Kedd N23646	Inmate Compliant	Unwanted Dialer Calls	4/21/2016	5/21/2016	Satisfactorily Resolved
IL	FCC	Inmate Dwayne Davis# M08877	Inmate Compliant	Cut of Calls	4/21/2016	5/21/2016	Satisfactorily Resolved
IL	FCC	Mary J Rubenstein	219-741-XXXX	FCC Rate Change	4/21/2016	5/21/2016	Satisfactorily Resolved
WI	FCC	Inmate Charles Wilson# 249903	Inmate Compliant	FCC Rate Change	4/21/2016	5/21/2016	Satisfactorily Resolved
CT	FCC	Daniela Milici	203-313-XXXX	FCC Rate Change	4/22/2016	5/22/2016	Satisfactorily Resolved
TX	FCC	Stella Eachus	214-354-XXXX	90 DAY Inactivity	4/25/2016	5/25/2016	Satisfactorily Resolved
WI	AGO	Inmate Damaris Griffin	Inmate Compliant	Refund Issue	4/28/2016	5/23/2016	Satisfactorily Resolved
WI	FCC	Inmate Koleh Wilson	Inmate Compliant	FCC Rate Change	4/29/2016	5/29/2016	Satisfactorily Resolved
MO	AGO	Thomas Brewer	573-788-XXXX	High Rates	5/11/2016	5/12/2016	Satisfactorily Resolved
TX	FCC	Linda Hopp	979-532-XXXX	FCC Rate Change	5/2/2016	6/1/2016	Satisfactorily Resolved
CT	FCC	Lyneen Smith	475-218-XXXX	FCC Rate Change	5/4/2016	6/3/2016	Satisfactorily Resolved
IL	FCC	Inmate Joseph Dole	Inmate Compliant	90 Day Inactivity	5/4/2016	6/3/2016	Satisfactorily Resolved
NM	FCC	Patricia A Flores	575-680-XXXX	Velocity Rules	5/4/2016	5/5/2016	Satisfactorily Resolved
WI	FCC	Shirley Laux	414-763-XXXX	Unwanted Dialer Calls	5/1/2016	5/16/2016	Satisfactorily Resolved
TX	FCC	Destiny Moore	936-615-XXXX	Payment: Special Rule	5/6/2016	6/5/2016	Satisfactorily Resolved
FL	FCC	Marsha Rule	850-877-XXXX	Fees: Wireless/Admin	5/6/2016	6/5/2016	Satisfactorily Resolved
OH	FCC	Kimberly Pace	330-461-XXXX	FCC Rate Change	5/9/2016	6/8/2016	Satisfactorily Resolved
GA	FCC	Michelle Regan	770-265-XXXX	Remote Call Forwarding/Call Diversio	5/9/2016	6/8/2016	Satisfactorily Resolved
IL	FCC	Ms. Sandra Lawrence	N/A	CNGC	5/10/2016	5/24/2016	Satisfactorily Resolved
WI	FCC	LEONARD MOORE	(715) 518-XXXX	High Rates/Remote Call Forwarding	5/12/2016	6/13/2016	Satisfactorily Resolved

OH	FCC	Joseph Jeffers	330-754-XXXX	Remote Call Forwarding	5/13/2016	6/13/2016	Satisfactorily Resolved
NM	FCC	EVANGELINE SALCIDO	303-524-XXXX	Billing Dispute	5/16/2016	6/9/2016	Satisfactorily Resolved
PA	FCC	Joan Boehm	717-334-XXXX	Automated Calls	5/17/2016	6/10/2016	Satisfactorily Resolved
NM	PSC	Christy Chavez	505-217-XXXX	FCC:High Rates	5/17/2016	6/9/2016	Satisfactorily Resolved
TX	FCC	Larry Levine /CARRIE MARTINI	254-613-XXXX	Remote Call Forwarding	5/18/2016	6/13/2016	Satisfactorily Resolved
IL	FCC	Ms. Sandra Lawrence	312-246-XXXX	Payment Issue	5/18/2016	5/27/2016	Satisfactorily Resolved
PA	FCC	ZUBAIDA QAZI	979-532-XXXX	Payment Issue	5/24/2016	6/14/2016	Satisfactorily Resolved
LA	FCC	Inmate Thomas Jackson/ Darren Hooks	Inmate Complaint	High Rates	6/1/2016	6/21/2016	Satisfactorily Resolved
LA	FCC	Barbara Forrest	985-630-XXXX	FCC Rate Change	6/1/2016	6/17/2016	Satisfactorily Resolved
AR	FCC	Inmate Jason Jordengreen	Inmate Complaint	Cut Off Calls (COC)	6/1/2016	6/17/2016	Satisfactorily Resolved
GA	FCC	Michelle Regan	770-265-XXXX	Refund Issue	6/2/2016	6/21/2016	Satisfactorily Resolved
OH	PSC	Mark Williams	409-220-XXXX	Rate Change	6/2/2016	6/17/2016	Satisfactorily Resolved
IL	FCC	Inmate Duane Wiedman	Inmate Complaint	High Rates	6/6/2016	6/29/2016	Satisfactorily Resolved
NC	FCC	Ronada Shelton	(210) 620-XXXX	Cut Off Calls (COC)	6/6/2016	6/9/2016	Satisfactorily Resolved
KY	FCC	Inmate Donald Phillips	Inmate Complaint	Payment: Special Rule	6/10/2016	6/24/2016	Satisfactorily Resolved
WI	AGO	Craig	608-518-XXXX	Unwanted Dialer Calls	6/14/2016	6/27/2016	Satisfactorily Resolved
SC	FCC	Dana Allen	864-310-XXXX	FCC Rate Change	6/17/2016	7/20/2016	Satisfactorily Resolved
WA	AGO	Kristy Heudinik	N/A	Account/Billing Conversion	6/20/2016	6/24/2016	Satisfactorily Resolved
IL	FCC	Luz C Colon	773-435-XXXX	Cut Off Calls (COC)	6/21/2016	7/11/2016	Satisfactorily Resolved
IN	PSC	Nichole Letley	260-243-XXXX	High Rates	6/21/2016	6/30/2016	Satisfactorily Resolved
NC	FCC	Charissa Melvin	336-494-XXXX	ROF / Call Diverter	6/21/2016	6/30/2016	Satisfactorily Resolved
FL	FCC	SAMANTHA WILSON	561-809-XXXX	FCC Rate Change	6/21/2016	6/30/2016	Satisfactorily Resolved
GA	FCC	Kimberly Broner	404-734-XXXX	Fees: Wireless/Admin/Regulatory	6/21/2016	6/30/2016	Satisfactorily Resolved
MO	FCC	Cynthia Draine	314-339-XXXX	Remote Call Forwarding/Call Diversio	6/21/2016	6/29/2016	Satisfactorily Resolved
MO	FCC	Jo Ann Drago	314-221-XXXX	FCC Rate Change	6/22/2016	7/8/2016	Satisfactorily Resolved
GA	FCC	LATREACE SIMMONS	678-643-XXXX	High Rates	6/22/2016	7/7/2016	Satisfactorily Resolved
TX	FCC	BRIAN FOSTER	940-393-XXXX	FCC Rate Change	6/23/2016	7/11/2016	Satisfactorily Resolved
MO	FCC	BARBARA MITCHELL	262-221-XXXX	FCC Rate Change	6/24/2016	7/19/2016	Satisfactorily Resolved
IN	FCC	Jennifer VanHook	260-350-XXXX	FCC Rate Change	6/24/2016	7/12/2016	Satisfactorily Resolved
NM	FCC	Inmate Ronnie King	Inmate Complaint	FCC Rate Change	6/24/2016	7/12/2016	Satisfactorily Resolved
TN	FCC	KELLIE HENDRIX	423-620-XXXX	FCC Rate Change	6/24/2016	7/12/2016	Satisfactorily Resolved
FL	FCC	STEPHANIE STEVENS	352-551-XXXX	FCC Rate Change	6/24/2016	7/12/2016	Satisfactorily Resolved
CO	FCC	SANDY MCMINN	720-296-XXXX	Fees	6/24/2016	7/11/2016	Satisfactorily Resolved
FL	FCC	Marsha Rule	850-877-XXXX	FCC Rate Change	6/24/2016	7/8/2016	Satisfactorily Resolved
IL	FCC	Meghan Lancaster	618-318-XXXX	Remote Call Forwarding/Call Diversio	6/27/2016	7/18/2016	Satisfactorily Resolved
OK	FCC	Tessa Robinson	918-944-XXXX	FCC Rate Change	6/27/2016	7/14/2016	Satisfactorily Resolved
MA	FCC	Karrn Guhrle	978-300-XXXX	Cut Off Calls (COC)	6/27/2016	7/14/2016	Satisfactorily Resolved
IL	FCC	Inmate Jason Wright	Inmate Complaint	High Rates	6/27/2016	7/11/2016	Satisfactorily Resolved
TX	FCC	Inmate James Crouch	Inmate Complaint	High Rates	6/28/2016	7/26/2016	Satisfactorily Resolved
VA	FCC	EARLENE PERRY	540-748-XXXX	FCC Rate Change	6/28/2016	7/21/2016	Satisfactorily Resolved
MS	FCC	GLORIA ALSUP	662-750-XXXX	FCC Rate Change	6/28/2016	7/21/2016	Satisfactorily Resolved
PA	FCC	LISA GREELEY	570-439-XXXX	FCC Rate Change	6/28/2016	7/20/2016	Satisfactorily Resolved

IA	FCC	Delta Erwin	870-565-XXXX	FCC Rate Change	6/28/2016	7/20/2016	Satisfactorily Resolved
WA	FCC	JILLIAN NEWINGHAM	253-503-XXXX	FCC Rate Change	6/28/2016	7/20/2016	Satisfactorily Resolved
TX	FCC	TANEKA BALDWIN	281-571-XXXX	FCC Rate Change	6/28/2016	7/20/2016	Satisfactorily Resolved
TX	FCC	Monica Brieger	512-203-XXXX	High Rates	6/28/2016	7/20/2016	Satisfactorily Resolved
VA	FCC	Inmate Robert Guilbranson	Inmate Compliant	FCC Rate Change	6/28/2016	7/19/2016	Satisfactorily Resolved
VA	FCC	Inmate Mike McVicker	Inmate Compliant	FCC Rate Change	6/28/2016	7/19/2016	Satisfactorily Resolved
MO	FCC	ERMIONI GREINKE	417-883-XXXX	FCC Rate Change	6/28/2016	7/19/2016	Satisfactorily Resolved
TX	FCC	SUSAN KUFFEL	817-659-XXXX	FCC Rate Change	6/28/2016	7/18/2016	Satisfactorily Resolved
CA	FCC	Veila Johnson	972-734-XXXX	FCC Rate Change	6/28/2016	7/18/2016	Satisfactorily Resolved
NY	FCC	JOYANNE KASMARCIK	585-285-XXXX	FCC Rate Change	6/28/2016	7/18/2016	Satisfactorily Resolved
MI	FCC	BETHANY SCHEPLER	810-989-XXXX	FCC Rate Change	6/28/2016	7/18/2016	Satisfactorily Resolved
MS	FCC	JULIE MILLS	662-803-XXXX	FCC Rate Change	6/28/2016	7/18/2016	Satisfactorily Resolved
MA	FCC	JAYME MCASSEY	774-291-XXXX	FCC Rate Change	6/28/2016	7/18/2016	Satisfactorily Resolved
CA	FCC	NIKAH HALVERSON	530-828-7899	FCC Rate Change	6/28/2016	7/18/2016	Satisfactorily Resolved
GA	FCC	BEVERLY SMITH	517-833-XXXX	FCC Rate Change	6/28/2016	7/15/2016	Satisfactorily Resolved
TX	FCC	Kenneth Adams	508-824-XXXX	Cut Off Calls (COC)	6/28/2016	7/14/2016	Satisfactorily Resolved
CA	FCC	Joseph Mettler	909-646-XXXX	None	6/29/2016	7/18/2016	Satisfactorily Resolved
GA	FCC	Tamara Hamilton	770-619-XXXX	FCC Rate Change	6/30/2016	7/20/2016	Satisfactorily Resolved
TX	FCC	Susan Keffel	817-659-XXXX	Billing Latency	7/5/2016	8/8/2016	Satisfactorily Resolved
WA	FCC	COREY DICKINSON	253-232-XXXX	FCC Rate Change	7/6/2016	7/25/2016	Satisfactorily Resolved
FL	FCC	NATALIE WHITE	904-614-XXXX	FCC Rate Change	7/6/2016	7/25/2016	Satisfactorily Resolved
MA	FCC	ROSA FALETTE	978-390-XXXX	FCC Rate Change	7/6/2016	7/25/2016	Satisfactorily Resolved
MA	FCC	VIRGINIA JACKSON	978-767-XXXX	FCC Rate Change	7/6/2016	7/25/2016	Satisfactorily Resolved
TX	FCC	STELLA EACHUS	214-354-XXXX	Customer Not Getting Calls	7/6/2016	7/21/2016	Satisfactorily Resolved
PA	FCC	Inmate Roshia Williams	Inmate Compliant	FCC Rate Change	7/8/2016	7/27/2016	Satisfactorily Resolved
WY	FCC	Inmate Robert Poutre	Inmate Compliant	FCC Rate Change	7/8/2016	7/28/2016	Satisfactorily Resolved
TN	FCC	DWAN GREY	615-506-XXXX	FCC Rate Change	7/8/2016	7/28/2016	Satisfactorily Resolved
CA	FCC	Inmate Mitchell Greene	Inmate Compliant	FCC Rate Change	7/8/2016	7/25/2016	Satisfactorily Resolved
MN	FCC	Emily Ballentine	612-385-XXXX	FCC Rate Change	7/19/2016	7/29/2016	Satisfactorily Resolved
MA	FCC	Dianne O'Connell	508-420-XXXX	FCC Rate Change	7/19/2016	7/28/2016	Satisfactorily Resolved
NM	FCC	Inmate Bentley Street	Inmate Compliant	FCC Rate Change	7/22/2016	8/8/2016	Satisfactorily Resolved
SC	FCC	SCOTT SAWYER	864-993-XXXX	FCC Rate Change	7/22/2016	8/3/2016	Satisfactorily Resolved
KY	FCC	RODNEY RANKIN	502-599-XXXX	High Rates	7/22/2016	8/3/2016	Satisfactorily Resolved
VA	FCC	Pat Young	540-205-XXXX	Payment: Collect vs Debit	7/22/2016	8/3/2016	Satisfactorily Resolved
KY	FCC	Ben Runner	270-202-XXXX	Unwanted Dialer Calls	7/22/2016	8/3/2016	Satisfactorily Resolved
TX	FCC	Samantha Shuffield	936-566-XXXX	High Rates	7/27/2016	8/3/2016	Satisfactorily Resolved
MT	PSC	Patricia Ramirez	406-952-XXXX	FCC Rate Change	7/28/2016	7/29/2016	Satisfactorily Resolved
TX	FCC	Inmate Compliant Richard Haskins	Inmate Compliant	FCC Rate Change	7/28/2016	7/29/2016	Satisfactorily Resolved
AZ	AGO	Nicole Olson	623-476-XXXX	SVV: Vial Issues	8/1/2016	8/23/2016	Satisfactorily Resolved
IL	AGO	Inmate Dwayne Bruce	Inmate Compliant	Payment: Special Rule	8/1/2016	8/11/2016	Satisfactorily Resolved
AZ	FCC	Inmate Casey Butler Ryan	Inmate Compliant	FCC Rate Change	8/1/2016	8/8/2016	Satisfactorily Resolved
KY	FCC	RENEE PRESTON	280-735-XXXX	FCC Rate Change	8/1/2016	8/4/2016	Satisfactorily Resolved

TX	FCC	ANDREA POINTER	737-529-XXXX	RCF / Call Diverter	8/1/2016	8/4/2016	Satisfactorily Resolved
TX	FCC	Robbie Brown	214-991-XXXX	FCC Rate Change	8/1/2016	8/4/2016	Satisfactorily Resolved
TX	FCC	Inmate Dana Brock	Inmate Compliant	FCC Rate Change	8/1/2016	8/3/2016	Satisfactorily Resolved
OK	FCC	STEYONINA JOHNSON	405-413-XXXX	FCC Rate Change	8/1/2016	8/3/2016	Satisfactorily Resolved
FL	FCC	KEELUNA CAMPBELL	352-792-XXXX	FCC Rate Change	8/2/2016	8/10/2016	Satisfactorily Resolved
MT	FCC	Inmate Ira Henderson	Inmate Compliant	FCC Rate Change	8/2/2016	8/6/2016	Satisfactorily Resolved
FL	FCC	Brittany Beaudry	352-702-XXXX	FCC Rate Change	8/2/2016	8/8/2016	Satisfactorily Resolved
MA	FCC	CRYSTAL VENTRILLO	978-489-5468	FCC Rate Change	8/3/2016	8/3/2016	Satisfactorily Resolved
NM	FCC	Pamela Lesiak	505-930-XXXX	FCC Rate Change	8/5/2016	8/6/2016	Satisfactorily Resolved
FL	DOACS	Charon Hammink	407-257-XXXX	Billing Latency	8/9/2016	8/31/2016	Satisfactorily Resolved
AZ	FCC	Inmate James Hale# B60722	Inmate Compliant	Cut Off Calls (COC)	8/9/2016	8/10/2016	Satisfactorily Resolved
SC	FCC	Russell Farnham	843-205-XXXX	None	8/10/2016	8/23/2016	Satisfactorily Resolved
OK	FCC	Tina Goertz	405-220-XXXX	FCC Rate Change	8/10/2016	8/15/2016	Satisfactorily Resolved
TX	FCC	JOANNE JONES	409-789-XXXX	FCC Rate Change	8/10/2016	8/15/2016	Satisfactorily Resolved
MI	FCC	Rick Hill	816-399-XXXX	RCF / Call Diverter	8/11/2016	8/31/2016	Satisfactorily Resolved
OK	FCC	Inmate John H. Dean	Inmate Compliant	Customer Not Getting Calls	8/17/2016	8/24/2016	Satisfactorily Resolved
MN	FCC	Peggy Reed	701-371-XXXX	FCC Rate Change	8/22/2016	8/31/2016	Satisfactorily Resolved
FL	FCC	RISHAE BROOKS	352-359-XXXX	FCC Rate Change	8/22/2016	8/23/2016	Satisfactorily Resolved
TX	FCC	Elizabeth Molfese	832-368-XXXX	FCC Rate Change	8/23/2016	8/30/2016	Satisfactorily Resolved
NC	AGO	Steven Applebee	336-250-XXXX	Unwanted Dialer Calls	8/23/2016	8/25/2016	Satisfactorily Resolved
TX	FCC	Delvin Smith	832-368-XXXX	FCC Rate Change	8/25/2016	8/29/2016	Satisfactorily Resolved
CT	FCC	Inmate Omar Miller#202230	Inmate Compliant	FCC Rate Change	8/30/2016	8/31/2016	Satisfactorily Resolved
TX	FCC	Jason D. Donet	956-203-XXXX	High Rates	8/31/2016	10/6/2016	Satisfactorily Resolved
CT	FCC	Nicolette Mills	203-688-XXXX	High Rates	8/31/2016	9/20/2016	Satisfactorily Resolved
IN	FCC	Elkhart Corpe	574-343-XXXX	Payment: Special Rule	8/31/2016	9/14/2016	Satisfactorily Resolved
CO	FCC	Anastasia Moore	720-422-XXXX	High Rates	8/31/2016	9/12/2016	Satisfactorily Resolved
IN	URC	Vince Klock	765-398-XXXX	Cut Off Calls (COC)	8/31/2016	9/9/2016	Satisfactorily Resolved
KS	FCC	Gina Wilhite	316-516-XXXX	High Rates	8/31/2016	9/9/2016	Satisfactorily Resolved
IL	FCC	Inmate Jamene Clay# R7 6622	Inmate Compliant	Billing Latency	8/31/2016	9/8/2016	Satisfactorily Resolved
TX	FCC	Deborah Cardenas	210-831-XXXX	FCC Rate Change	9/6/2016	9/8/2016	Satisfactorily Resolved
GA	FCC	Allen Conley	770-355-XXXX	FCC Rate Change	9/13/2016	9/13/2016	Satisfactorily Resolved
AZ	FCC	Patricia Waldendorf	520-378-XXXX	Account/Billing Conversion	9/14/2016	9/20/2016	Satisfactorily Resolved
MS	FCC	Inmate Breck Bradshaw, K72355	Inmate Compliant	Refund Check Delivery Times	9/15/2016	9/15/2016	Satisfactorily Resolved
IL	AGO	Lewis Henry	Inmate Compliant	Refund Issue	9/20/2016	9/28/2016	Satisfactorily Resolved
NC	FCC	Inmate Jerry Johnson	Inmate Compliant	High Rates	9/20/2016	9/20/2016	Satisfactorily Resolved
GA	FCC	Inmate Jon Krueger	Inmate Compliant	High Rates	9/27/2016	9/28/2016	Satisfactorily Resolved
MO	FCC	Mindy Doggette	636-235-XXXX	None	9/28/2016	10/18/2016	Satisfactorily Resolved
VA	FCC	Inmate Edduardo Ferguson	Inmate Compliant	None	9/28/2016	10/4/2016	Satisfactorily Resolved
IL	FCC	Tracy Lehr	618-697-XXXX	High Rates	9/29/2016	10/18/2016	Satisfactorily Resolved
WI	FCC	Inmate Lorenzo Johnson	Inmate Compliant	Payment Processing Times	9/29/2016	10/12/2016	Satisfactorily Resolved
TX	FCC	Craig Smith	832-368-XXXX	Unwanted Dialer Calls	9/29/2016	10/10/2016	Satisfactorily Resolved
FL	FCC	Don Paul	954-709-XXXX	Cut Off Calls (COC)	9/29/2016	10/6/2016	Satisfactorily Resolved

KS	FCC	Linda Fagan	316-312-XXXX			9/30/2016	10/6/2016	Satisfactorily Resolved
MA	FCC	Debra Wright-Hinds	508-285-XXXX	High Rates		10/13/2016	10/18/2016	Satisfactorily Resolved
LA	FCC	KIM NGUYEN	504-319-XXXX	High Rates		10/17/2016	11/8/2016	Satisfactorily Resolved
GA	FCC	KAROLE CRAWFORD	770-873-6090	High Rates		10/17/2016	11/8/2016	Satisfactorily Resolved
TX	FCC	Glenda Blackmon	713-884-1405	Cut Off Calls (COC)		10/17/2016	11/8/2016	Satisfactorily Resolved
NM	FCC	CHERYL MACKEY	575-441-6683	High Rates		10/17/2016	11/12/2016	Satisfactorily Resolved
CT	FCC	Victoria Milne	203-252-XXXX	High Rates		10/17/2016	11/12/2016	Satisfactorily Resolved
FL	FCC	Kayla Henderson	396-561-9434	High Rates		10/17/2016	10/31/2016	Satisfactorily Resolved
NM	FCC	Inmate Bentley Street	Inmate Compliant	High Rates		10/17/2016	10/25/2016	Satisfactorily Resolved
GA	FCC	Shirley Teems	770-382-XXXX	Unwanted Dialer Calls		10/18/2016	11/8/2016	Satisfactorily Resolved
FL	FCC	ANDREA Bleicher	850-329-2463	High Rates		10/19/2016	11/4/2016	Satisfactorily Resolved
TX	FCC	Cindy Jones	979-417-XXXX	Refund Issue		10/19/2016	11/22/2016	Satisfactorily Resolved
TX	FCC	Carol Anne Mahory	281-452-XXXX	None		10/19/2016	10/25/2016	Satisfactorily Resolved
LA	FCC	JOHN OGDEN	713-208-XXXX	High Rates		10/19/2016	10/24/2016	Satisfactorily Resolved
KS	FCC	MICHAELA LYNES	316-730-0094	High Rates		10/19/2016	10/24/2016	Satisfactorily Resolved
WI	FCC	Inmate Toby Hill	Inmate Compliant	Payment Issue		10/19/2016	11/14/2016	Satisfactorily Resolved
NM	FCC	DESIREE FERNANDL	575-993-XXXX	High Rates		10/19/2016	11/14/2016	Satisfactorily Resolved
LA	FCC	Inmate Dr. Eric Denet/380958	Inmate Compliant	High Rates		10/28/2016	11/10/2016	Satisfactorily Resolved
LA	FCC	Gammie Maturin	225-329-XXXX	High Rates		11/8/2016	11/10/2016	Satisfactorily Resolved
IL	AGO	Charlie Franklin	773-653-XXXX	High Rates		11/10/2016	11/14/2016	Satisfactorily Resolved
IL	FCC	Inmate Francisco Gonzalez	Inmate Compliant	Customer Not Getting Calls		11/14/2016	11/21/2016	Satisfactorily Resolved
LA	FCC	Kiesha Keller	504-884-XXXX	High Rates		11/15/2016	11/22/2016	Satisfactorily Resolved
MA	FCC	Thomas Daly	781-479-8188	High Rates		11/15/2016	11/22/2016	Satisfactorily Resolved
LA	FCC	Solomon Washington#16026	Inmate Compliant	High Rates		11/15/2016	11/21/2016	Satisfactorily Resolved
MA	FCC	Steven Sommer	Inmate Compliant	High Rates		11/15/2016	pending	Satisfactorily Resolved
SC	ORS	Candance Smith	803-413-XXXX	High Rates		11/16/2016	11/21/2016	Satisfactorily Resolved
AK	FCC	KATHLEEN DOWNS	907-746-XXXX	Payment: Special Rule		11/21/2016	11/22/2016	Satisfactorily Resolved
KS	FCC	Bred Evans	785-845-XXXX	High Rates		11/22/2016	pending	Satisfactorily Resolved
MA	FCC	Donna Mazialnik	978-503-XXXX	High Rates		11/22/2016	pending	Satisfactorily Resolved
TX	FCC	Inmate Matthew J. Leachman	Inmate Compliant	High Rates		11/22/2016	pending	Satisfactorily Resolved
WI	FCC	Carla Padovani	715-554-XXXX	High Rates		11/23/2016	12/5/2016	Satisfactorily Resolved
GA	FCC	Linda Walliate	470-428-XXXX	High Rates		11/25/2016	pending	pending
CA	FCC		Inmate Compliant	High Rates			pending	pending
WI	FCC	Keith McAtee 227500	Inmate Compliant	High Rates		11/30/2016	pending	pending
PA	FCC	Inmate Raymond Hargrove KC/3539	Inmate Compliant	High Rates		11/30/2016	pending	pending
AK	RCA	Loretta Gaines	907-687-XXXX	Billing Dispute		11/28/2016	12/6/2016	Satisfactorily Resolved
NM	PSC	Lydia Torres	505-440-XXXX	Billing Dispute		11/30/2016	12/6/2016	Satisfactorily Resolved

Please note that Securus has redacted customer identifying information for telephone numbers from the complaint information provided. Federal, 47 CFR, Subpart J-Customer Proprietary Network Information ("CPNI") rules protect customers from the release of such information without their consent.

Acronyms

DAK Denies All Knowledge

HV	High Velocity
HT	High Toll
NA	Not Available
COC	Out Off Calls
RCF	Remote Call Forwarding
AGO	Attorney General Office
PUC	Public Utility Commissions
FCC	Federal Communications Commission
LEC	Local Exchange Carrier
CNGC	Customer Not Getting Calls
SW	Securus Video Visitation

STATE OF NEW YORK DEPARTMENT OF PUBLIC SERVICE
THREE EMPIRE STATE PLAZA, ALBANY, NY 12223-1350
www.dps.state.ny.us

PUBLIC SERVICE COMMISSION

GARRY A. BROWN
Chairman
PATRICIA L. ACAMPORA
MAUREEN F. HARRIS
ROBERT E. CURRY JR.
JAMES L. LAROCCA
Commissioners



PETER MCGOWAN
General Counsel

JACLYN A. BRILLING
Secretary

December 13, 2010

Mr. Curt's L. Hopfinger
Director, Regulatory & Government Affairs
Evercom Systems, Inc.
1485 Dallas Parkway, Suite 800
Dallas, Texas 75254

Re: Matter No. 10-02604

Dear Mr. Hopfinger:

The Adoption Supplement filed by Evercom Systems, Inc. on November 12, 2010 with regard to its NY PSC Tariff No. 1 – Telephone tariff was received. The company request to change its name thereon to Securix Technologies, Inc. was effective November 13, 2010.

Within one year, the adopted schedule must be reissued by the successor company under the proper PSC number in its series.

Also, a new or revised Telecommunications Carrier Critical Information (TCCI) form must be submitted to Jaclyn A. Brillig, Secretary. The TCCI form is available at <http://www3.dps.state.ny.us/T/TelephoneDb.nsf/printableTCCIForm?OpenForm>. If you have any questions regarding the TCCI form, please contact Judy Sylvester at (518) 473-8074.

Very truly yours,

Gary Hidenbrant
Utility Engineer 2 (Telecommunications)

cc. G. Pattenauze
J. Sylvester

FILED: SESSION OF DEC 15 1999

Approved as Recommended
and so Ordered
By the Commission

DEBRA RENNER
Acting Secretary

STATE OF NEW YORK
DEPARTMENT OF PUBLIC SERVICE

MAILED &
EFFECTIVE DEC 16 1999

November 18, 1999

TO: THE COMMISSION

FROM: OFFICE OF COMMUNICATIONS

SUBJECT: CASE 99-C-1491 - Joint petition of Evercom Systems, Inc. and Saratoga Telephone Company, Inc. for authority for Saratoga Telephone Company, Inc. to merge with Evercom Systems, Inc.

RECOMMENDATION:

It is recommended that the Commission grant approval, pursuant to Section 99 of the Public Service Law, for Saratoga Telephone Company, Inc. to merge with Evercom Systems, Inc. Immediately after consummation of the transaction approved herein, Saratoga Telephone Company, Inc. should be required to file a supplement with the Acting Secretary to the Commission canceling the tariff of Saratoga Telephone Company, Inc. and cancelling its certificate of Convenience and Necessity to resell telecommunications in New York.

Introduction

By joint petition filed October 14, 1999, pursuant to Section 99 of the Public Service Law, Evercom Systems, Inc. and Saratoga Telephone Company, Inc. request authority for Saratoga Telephone Company, Inc. to merge with Evercom Systems, Inc.

Background

Evercom Systems, Inc. (ESI) and Saratoga Telephone Company, Inc. (Saratoga) are both wholly owned subsidiaries of Evercom, Inc. (Evercom). Evercom is a Delaware corporation whose principal business office is at 611 SW Third St, Lee's Summit, MO 64053.

Conclusion

The proposed transaction does not appear to be contrary to the public interest. The Office of Communications has no objection to the transaction and recommends approval.

Respectfully submitted,

WAYNE A. CORNELIUS
Policy Analyst III

Reviewed by,

MAUREEN J. McCauley
Office of General Counsel

Reviewed by,

JOHN RUBINO
Associate Valuation Engineer

APPROVED:

ROBERT LA MARCHE
Chief, Office of Communications

END OF SECTION 6: VENDOR QUALIFICATIONS

8 Contractual Issues

8.1 Appendix A / Order of Precedence

Appendix A — Standard Clauses for New York State Contracts, dated January 2014, attached hereto, is hereby expressly made a part of this solicitation document as fully as if set forth at length herein. The agreement resulting from a successful award will include the following documents.

Conflicts between these documents will be resolved in the following descending order of precedence:

- Appendix A
- The Contract resulting from this RFP
- DOCCS Request for Proposal Number 2016-02 (this Document) including any addenda
- Selected Contractor's Proposal/Bid

SECURUS HAS READ, AGREES AND WILL COMPLY WITH THIS REQUIREMENT.

8.2 Ethics Compliance

All proposers/contractors and their employees must comply with the requirements of §§73 and 74 of the Public Officers Law, other state codes, rules, regulations, and executive orders establishing ethical standards for the conduct of business with New York State. In signing the Contract, the Contractor certifies full compliance with those provisions for any present or future dealings, transactions, sales, contracts, services, offers, relations, etc., involving New York State and/or its employees. Failure to comply with those provisions may result in disqualification from the proposal process, termination of contract, and/or other civil or criminal proceedings as required by law.

SECURUS HAS READ, AGREES AND WILL COMPLY WITH THIS REQUIREMENT.

8.3 Procurement Lobbying Act

New York's Legislative Law and the State Finance Law have been amended to regulate lobbying on procurement contracts. Chapter 1 of the Laws of 2005, State Finance Law § 139-j and k, which can be accessed through the NYS Office of General Services links below, imposes certain restrictions on communications between the Department and the bidder during the procurement process. The bidder is restricted from making contacts, beginning with the date of the bid advertisement in the NYS Contract Reporter through final approval of the contract award by the Office of the State Comptroller, with anyone other than the designated contact person identified in the RFP, unless it is contact that is among certain statutory exceptions as per State Finance Law § 139-k (3) (a). The designated staff are identified in Section 1.6 RFP. Department staff are required to obtain certain information when contacted during the "restricted period" and to make a determination of responsibility of the bidder pursuant to these two statutes. Certain findings of non-responsibility can result in

rejection of the proposal, and in the event of two findings within a four-year period, the bidder is debarred from future State contracts. It is DOCCS' policy to immediately report to its ethics officer and/or inspector general any impermissible contact by any offeror (bidder) and, in addition, to comply with all requirements of the procurement lobbying and procurement stewardship acts. More information about State Finance Law Sections 139-j and k can be found on the website of the Office of General Services by accessing the following:

<http://www.ogs.ny.gov/aboutogs/regulations/advisoryCouncil/sfl139-j.htm>

and <http://www.ogs.ny.gov/aboutogs/regulations/advisoryCouncil/sfl139-k.htm>

All bidders must submit a completed *Procurement Lobbying Certificate* related to State Finance Law 139-j and k (Attachment C).

SECURUS HAS READ, AGREES AND WILL COMPLY WITH THIS REQUIREMENT.

Please see section/tab – COMPLETED FORMS – Procurement Lobbying Certificate. (page 643)

8.4 Sales and Compensating Use Tax Certification Requirements

Complete **Form ST-220-CA Contractor Certification**. The Contractor must file Form ST-220-CA to certify that it has filed Form ST-220-TD with the Tax Department and that the information contained on Form ST-220-TD is correct and complete as of the date that the Contractor files Form ST-220-CA. Access and complete Form ST-220-CA by using the following link:

http://www.tax.ny.gov/pdf/current_forms/st/st220ca_fill_in.pdf Please note that Form ST-220-TD must be filed with the NYS Tax Department at the address on the front page of the form. You can access Form ST-220-TD using the following link:

http://www.tax.ny.gov/pdf/current_forms/st/st220td_fill_in.pdf For *Questions and Answers Concerning Tax Law Section 5-a*, go to NYS Department of Tax and Finance at <http://www.tax.ny.gov/pdf/publications/sales/pub223.pdf>.

SECURUS HAS READ, AGREES AND WILL COMPLY WITH THIS REQUIREMENT.

8.5 Encouraging the Use of NYS Business

In an ongoing effort to use New York State (NYS) businesses, DOCCS encourages bidders to partner with NYS subcontractors and/or suppliers. For this solicitation, bidders should identify the NYS businesses that they plan to use if awarded the contract resulting from this solicitation by completing the form entitled *Encouraging Use of New York State Businesses in Contract Performance*. If known, please identify the businesses and attach the requested information. Return the completed form with your proposal. If you do not plan to partner with a NYS business, please indicate this on the form and return it with your proposal. This form is included in Attachment C.

SECURUS HAS READ, AGREES AND WILL COMPLY WITH THIS REQUIREMENT.

8.6 Diversity Practices

DOCCS has determined, pursuant to New York State Executive Law Article 15-A, that the assessment of the diversity practices of respondents to this procurement is practical, feasible, and appropriate. Diversity practices are the efforts of contractors to include New York State-certified Minority and Women-owned Business Enterprises (“M/WBEs”) in their business practices. Diversity practices may include past, present, or future actions and policies, and include activities of contractors contracts with private entities and governmental units other than the State of New York. Assessing the diversity practices of contractors enables contractors to engage in meaningful, capacity-building collaborations with M/WBEs.

Accordingly, respondents to this procurement shall be required to include as part of the technical proposal response to this procurement, as described in this RFP herein, the *Diversity Practices Questionnaire* as provided by the Division of Minority and Women’s Business Development.

Bidders must complete the questionnaire in Appendix M. The bidders’ responses will be evaluated using a predetermined rating scale.

SECURUS HAS READ, AGREES AND WILL COMPLY WITH THIS REQUIREMENT.

8.7 M/WBE and EEO Requirements

See Appendix C for Contractor requirements and procedures. The selected bidder will be required to return a completed Utilization Plan (Form M/WBE 100-G) and a completed Staffing Plan (Form EEO 100) as part of the contract resulting from this RFP. Appendix C will be included in the Contract resulting from this RFP.

SECURUS HAS READ, AGREES AND WILL COMPLY WITH THIS REQUIREMENT.

8.8 Use of Service-Disabled Veteran-Owned Business Enterprises in Contract Performance

Article 17-B of the Executive Law enacted in 2014 acknowledges that Service-Disabled Veteran- Owned Businesses (SDVOBs) strongly contribute to the economies of the State and the nation. As defenders of our nation and in recognition of their economic activity in doing business in New York State, bidders/proposers for this contract for commodities, services or technology are strongly encouraged and expected to consider SDVOBs in the fulfillment of the requirements of the contract. Such partnering may be as subcontractors, suppliers, protégés or other supporting roles. SDVOBs can be readily identified on the directory of certified businesses at: <http://www.ogs.ny.gov/Core/SDVOBA.asp>

Bidders/proposers need to be aware that all authorized users of this contract will be strongly encouraged to the maximum extent practical and consistent with legal requirements of the State Finance Law and the Executive Law to use responsible and responsive SDVOBs in purchasing and utilizing commodities, services and technology that are of equal quality and functionality to those that may be obtained from non-SDVOBs. Furthermore, bidders/proposers are reminded that they must continue to utilize small, minority and women-owned businesses consistent with current State law. Utilizing SDVOBs in State contracts will help create more private sector jobs, rebuild New York State’s infrastructure, and maximize economic activity to the mutual benefit of the contractor and its SDVOB partners. SDVOBs will promote the contractor’s optimal performance under the contract,

thereby fully benefiting the public sector programs that are supported by associated public procurements.

Public procurements can drive and improve the State's economic engine through promotion of the use of SDVOBs by its contractors. The State, therefore, expects bidders/proposers to provide maximum assistance to SDVOBs in their contract performance. The potential participation by all kinds of SDVOBs will deliver great value to the State and its taxpayers.

SECURUS HAS READ, AGREES AND WILL COMPLY WITH THIS REQUIREMENT.

8.9 Indemnification

The Contractor shall assume all risks of liability for its performance, or that of any of its officers, employees, subcontractors, independent contractors, agents or any other person or entity performing contractual duties on Contractor's behalf, of any contract resulting from this solicitation and shall be solely responsible and liable for all liabilities, losses, damages, costs or expenses, including attorney's fees, arising from any claim, action or proceeding relating to or in any way connected with the performance of this Agreement and covenants and agrees to defend, indemnify and hold harmless the State of New York, its agents, officers and employees, from any and all claims, suits, causes of action and losses of whatever kind and nature, arising out of or in connection with its performance of any contract resulting from this solicitation, including negligence, active or passive or improper conduct of the Contractor, its officers, agents, subcontractors or employees, or the failure by the Contractor, its officers, agents, subcontractors or employees to perform any obligations or commitments to the State or third parties arising out of or resulting from any contract resulting from this solicitation. Such indemnity shall not be limited to the insurance coverage herein prescribed.

SECURUS HAS READ, AGREES AND WILL COMPLY WITH THIS REQUIREMENT.

8.10 Contractor Insurance Requirements

Prior to the commencement of the work to be performed by the Contractor hereunder, the Contractor shall file with The People of the State of New York, DOCCS, Certificates of Insurance (hereinafter referred to as "Certificates"), evidencing compliance with all requirements. Such Certificates shall be of a form and substance acceptable to DOCCS.

Certificate acceptance and/or approval by DOCCS does not and shall not be construed to relieve Contractor of any obligations, responsibilities or liabilities under the Contract.

Contractors shall be required to procure, at their sole cost and expense, and shall maintain in force at all times during the term of any Contract resulting from this Solicitation, policies of insurance as required by this Section. All insurance required by this Section shall be written by companies that have an A.M. Best Company rating of "A-," Class "VII" or better. In addition, companies writing insurance intended to comply with the requirements of this Section should be licensed or authorized by the New York State Department of Financial Services to issue insurance in the State of New York. DOCCS may, in its sole discretion, accept policies of insurance written by a non-authorized carrier or carriers when certificates and/or other policy documents are accompanied by a completed Excess Lines Association of New York (ELANY) affidavit or other documents demonstrating the company's strong financial rating. If, during the term of a policy, the carrier's A.M. Best rating falls below "A-,"

Class "VII," the insurance must be replaced, on or before the renewal date of the policy, with insurance that meets the requirements above.

Bidders and Contractors shall deliver to DOCCS evidence of the insurance required by this Solicitation and any Contract resulting from this Solicitation in a form satisfactory to DOCCS. Policies must be written in accordance with the requirements of the paragraphs below, as applicable. While acceptance of insurance documentation shall not be unreasonably withheld, conditioned or delayed, acceptance and/or approval by DOCCS does not, and shall not be construed to, relieve Bidders or Contractors of any obligations, responsibilities or liabilities under this Solicitation or any Contract resulting from this Solicitation.

The Contractor shall not take any action, or omit to take any action that would suspend or invalidate any of the required coverages during the term of the Contract.

- A. General Conditions Applicable to Insurance.** All policies of insurance required by this Solicitation or any Contract resulting from this Solicitation shall comply with the following requirements:
1. Coverage Types and Policy Limits. The types of coverage and policy limits required from Bidders and Contractors are specified in Paragraph B Insurance Requirements below.
 2. Policy Forms. Except as otherwise specifically provided herein, or agreed to in the Contract resulting from this Solicitation, all policies of insurance required by this Section shall be written on an occurrence basis.
 3. Certificates of Insurance/Notices. Bidders and Contractors shall provide DOCCS with a Certificate or Certificates of Insurance, in a form satisfactory to DOCCS as detailed below, and pursuant to the timelines set forth in Section B below. Certificates shall reference the Solicitation or award number and shall name The New York State Department of Corrections and Community Supervision, Harriman Campus, 1220 Washington Avenue, Albany, New York 12226-2050, as the certificate holder.

Certificates of Insurance shall

- Be in the form acceptable to DOCCS and in accordance with the New York State Insurance Law (e.g., an ACORD certificate);
- Disclose any deductible, self-insured retention, aggregate limit or exclusion to the policy that materially changes the coverage required by this Solicitation or any Contract resulting from this Solicitation;
- Refer to this Solicitation and any Contract resulting from this Solicitation by award number;
- Be signed by an authorized representative of the referenced insurance carriers; and
- Contain the following language in the Description of Operations / Locations / Vehicles section: Additional insured protection afforded is on a primary and non- contributory basis. A waiver of subrogation is granted in favor of the additional insureds.

Only original documents (certificates of insurance and any endorsements and other attachments) or electronic versions of the same that can be directly

traced back to the insurer, agent or broker via e-mail distribution or similar means will be accepted.

DOCCS generally requires Contractors to submit only certificates of insurance and additional insured endorsements, although DOCCS reserves the right to request other proof of insurance. Contractors should refrain from submitting entire insurance policies, unless specifically requested by DOCCS. If an entire insurance policy is submitted but not requested, DOCCS shall not be obligated to review and shall not be chargeable with knowledge of its contents. In addition, submission of an entire insurance policy not requested by DOCCS does not constitute proof of compliance with the insurance requirements and does not discharge Contractors from submitting the requested insurance documentation.

SECURUS HAS READ, AGREES AND WILL COMPLY WITH THIS REQUIREMENT.

- 4. Primary Coverage.** All liability insurance policies shall provide that the required coverage shall be primary and non-contributory to other insurance available to the People of the State of New York, the New York State Department of Corrections and Community Supervision, any entity authorized by law or regulation to use the Contract and their officers, agents, and employees. Any other insurance maintained by the People of the State of New York, the New York State Department of Corrections and Community Supervision, any entity authorized by law or regulation to use the Contract and their officers, agents, and employees shall be excess of all applicable Contractor's insurance, including any umbrella and/or excess policies, and shall not contribute with the Bidder/Contractor's insurance.

SECURUS HAS READ, AGREES AND WILL COMPLY WITH THIS REQUIREMENT.

- 5. Breach for Lack of Proof of Coverage.** The failure to comply with the requirements of this Section at any time during the term of the Contract shall be considered a breach of the terms of the Contract and shall allow the People of the State of New York, the New York State Department of Corrections and Community Supervision, any entity authorized by law or regulation to use the Contract and their officers, agents, and employees to avail themselves of all remedies available under the Contract or at law or in equity.

SECURUS HAS READ, AGREES AND WILL COMPLY WITH THIS REQUIREMENT.

- 6. Self-Insured Retention/Deductibles.** Certificates of Insurance must indicate the applicable deductibles/self-insured retentions for each listed policy. Deductibles or self-insured retentions above \$100,000.00 are subject to approval from DOCCS. Such approval shall not be unreasonably withheld, conditioned or delayed. Bidders and Contractors shall be solely responsible for all claim expenses and loss payments within the deductibles or self-insured retentions. If the Bidder/Contractor is providing the required insurance through self-insurance, evidence of the financial capacity to support the self-insurance program along with

a description of that program, including, but not limited to, information regarding the use of a third-party administrator shall be provided upon request. If the Contractor is unable to meet their obligation under any deductible, self-insured retention or self-insurance, neither the People of the State of New York nor DOCCS will be obligated to drop down to cover the amount of the self-insured retention or deductible or any remaining portion thereof.

SECURUS HAS READ, AGREES AND WILL COMPLY WITH THIS REQUIREMENT.

- 7. Subcontractors.** Prior to the commencement of any work by a Subcontractor, the Contractor shall require such Subcontractor to procure policies of insurance as required by this Section and maintain the same in force during the term of any work performed by that Subcontractor.

SECURUS HAS READ, AGREES AND WILL COMPLY WITH THIS REQUIREMENT.

- 8. Waiver of Subrogation.** For all liability policies and the workers' compensation insurance required below, the Bidder/Contractor shall cause to be included in its policies insuring against loss, damage or destruction by fire or other insured casualty a waiver of the insurer's right of subrogation against The People of the State of New York, the New York State Department of Corrections and Community Supervision, any entity authorized by law or regulation to use the Contract and their officers, agents, and employees, or, if such waiver is unobtainable (i) an express agreement that such policy shall not be invalidated if the Contractor waives or has waived before the casualty, the right of recovery against The People of the State of New York, the New York State Department of Corrections and Community Supervision, any entity authorized by law or regulation to use the Contract and their officers, agents, and employees or (ii) any other form of permission for the release of The People of the State of New York, the New York State Department of Corrections and Community Supervision, any entity authorized by law or regulation to use the Contract and their officers, agents, and employees. A Waiver of Subrogation Endorsement shall be provided upon request. A blanket Waiver of Subrogation Endorsement evidencing such coverage is also acceptable.

SECURUS HAS READ, AGREES AND WILL COMPLY WITH THIS REQUIREMENT.

- 9. Additional Insured** The Contractor shall cause to be included in each of the liability policies required below, ISO form CG 20 10 11 85 (or a form or forms that provide equivalent coverage, such as the combination of CG 20 10 04 13 and CG 20 37 04 13) and form CA 20 48 10 13 (or a form or forms that provide equivalent coverage), naming as additional insureds: The People of the State of New York, the New York State Department of Corrections and Community Supervision, any entity authorized by law or regulation to use the Contract and their officers, agents, and employees. An Additional Insured Endorsement evidencing such coverage shall be provided to DOCCS pursuant to the timelines set forth in Section B below. A blanket Additional Insured Endorsement evidencing such

coverage is also acceptable. For Contractors who are self-insured, the Contractor shall be obligated to defend and indemnify the above-named additional insureds with respect to Commercial General Liability and Business Automobile Liability, in the same manner that the Contractor would have been required to pursuant to this Section had the Contractor obtained such insurance policies.

SECURUS HAS READ, AGREES AND WILL COMPLY WITH THIS REQUIREMENT.

- 10. Excess/Umbrella Liability Policies.** Required insurance coverage limits may be provided through a combination of primary and excess/umbrella liability policies; however, a minimum of one million dollars (\$1,000,000.00) must be primary coverage for general liability and auto liability. All Contractor's applicable insurance policies, including umbrella and excess insurance, will be primary to any insurance, self-insurance, deductible or self-insured retention of the People of the State of New York, the New York State Department of Corrections and Community Supervision, or any entity authorized by law or regulation to use the Contract and their officers, agents, and employees. If coverage limits are provided through excess/umbrella liability policies, then a Schedule of underlying insurance listing policy information for all underlying insurance policies (insurer, policy number, policy term, coverage and limits of insurance), including proof that the excess/umbrella insurance follows form must be provided upon request.

SECURUS HAS READ, AGREES AND WILL COMPLY WITH THIS REQUIREMENT.

- 11. Notice of Cancellation or Non-Renewal.** Policies shall be written so as to include the requirements for notice of cancellation or non-renewal in accordance with the New York State Insurance Law. Within five (5) business days of receipt of any notice of cancellation or non-renewal of insurance, the Contractor shall provide DOCCS with a copy of any such notice received from an insurer together with proof of replacement coverage that complies with the insurance requirements of this Solicitation and any Contract resulting from this Solicitation.

SECURUS HAS READ, AGREES AND WILL COMPLY WITH THIS REQUIREMENT.

- 12. Policy Renewal/Expiration** Upon policy renewal/expiration, evidence of renewal or replacement of coverage that complies with the insurance requirements set forth in this Solicitation and any Contract resulting from this Solicitation shall be delivered to DOCCS. If, at any time during the term of any Contract resulting from this Solicitation, the coverage provisions and limits of the policies required herein do not meet the provisions and limits set forth in this Solicitation or any Contract resulting from this Solicitation, or proof thereof is not provided to DOCCS, the Contractor shall immediately cease work. The Contractor shall not resume work until authorized to do so by DOCCS.

SECURUS HAS READ, AGREES AND WILL COMPLY WITH THIS REQUIREMENT.

13. **Deadlines for Providing Insurance Documents after Renewal or Upon Request.** As set forth herein, certain insurance documents must be provided to the DOCCS Procurement Services contact identified in the Contract Award Notice after renewal or upon request. This requirement means that the Contractor shall provide the applicable insurance document to DOCCS as soon as possible but in no event later than the following time periods:

- For certificates of insurance: 5 business days
- For information on self-insurance or self-retention programs: 15 calendar days
- For other requested documentation evidencing coverage: 15 calendar days
- For additional insured and waiver of subrogation endorsements: 30 calendar days

Notwithstanding the foregoing, if the Contractor shall have promptly requested the insurance documents from its broker or insurer and shall have thereafter diligently taken all steps necessary to obtain such documents from its insurer and submit them to DOCCS, DOCCS shall extend the time period for a reasonable period under the circumstances, but in no event shall the extension exceed 30 calendar days.

SECURUS HAS READ, AGREES AND WILL COMPLY WITH THIS REQUIREMENT.

B. Insurance Requirements

Bidders and Contractors shall obtain and maintain in full force and effect, throughout the term of any Contract resulting from this Solicitation, at their own expense, the following insurance with limits not less than those described below and as required by the terms of any Contract resulting from this Solicitation, or as required by law, whichever is greater:

Insurance Type		Proof of Coverage is Due
Commercial General Liability	[Not less than \$2,000,000 each occurrence]	Updated in accordance with Contract
General Aggregate	\$2,000,000	
Products – Completed Operations Aggregate	\$2,000,000	
Personal and Advertising Injury	\$1,000,000	
Medical Expenses Limit	\$5,000	
Business Automobile Liability Insurance	[Not less than \$2,000,000 each occurrence]	
Workers' Compensation		
Disability Benefits		

SECURUS HAS READ, AGREES AND WILL COMPLY WITH THIS REQUIREMENT.

1. **Commercial General Liability Insurance:** Such liability shall be written on the current edition of ISO occurrence form CG 00 01, or a substitute form providing equivalent coverage and shall cover liability arising from premises operations, independent contractors, products-completed operations, broad form property damage, personal & advertising injury, cross liability coverage, liability assumed in a contract (including the tort liability of another assumed in a contract) and explosion, collapse & underground coverage.

Policy shall include bodily injury, property damage and broad form contractual liability coverage.

- General Aggregate
- Products – Completed Operations Aggregate
- Personal and Advertising Injury
- Each Occurrence

Coverage shall include, but not be limited to, the following:

- Premises liability;
- Independent contractors;
- Blanket contractual liability, including tort liability of another assumed in a contract;
- Defense and/or indemnification obligations, including obligations assumed under the Contract;
- Cross liability for additional insureds;
- Products/completed operations for a term of no less than three [1-3] years, commencing upon acceptance of the work, as required by the Contract;
- Explosion, collapse and underground hazards; and
- Contractor means and methods].

SECURUS HAS READ, AGREES AND WILL COMPLY WITH THIS REQUIREMENT.

2. **Business Automobile Liability Insurance:** Such insurance shall cover liability arising out of any automobile used in connection with performance under the Contract, including owned, leased, hired and non-owned automobiles bearing or, under the circumstances under which they are being used, required by the Motor Vehicles Laws of the State of New York to bear, license plates.

In the event that the Contractor does not own, lease or hire any automobiles used in connection with performance under the Contract, the Contractor does not need to obtain Business Automobile Liability Insurance, but must attest to the fact that the Contractor does not own, lease or hire any automobiles used in connection with performance under the Contract on a form provided by DOCCS. If, however, during the term of the Contract, the Contractor acquires, leases or hires any automobiles that will be used in connection with performance under the Contract, the Contractor must obtain Business Automobile Liability Insurance that meets all of the requirements of this section and provide proof of such coverage to DOCCS in accordance with the insurance requirements of any Contract resulting from this Solicitation.

In the event that the Contractor does not own or lease any automobiles used in connection with performance under the Contract, but the Contractor does subcontract, hire and/or utilize non-owned automobiles in connection with performance under the Contract, the Contractor subcontractor or owner of the automobile(s) must: (i) obtain Business Automobile Liability Insurance as required by this Solicitation or any Contract resulting from this Solicitation, except that such insurance may be limited to liability arising out of hired and/or non-owned automobiles, as applicable; and (ii) attest to the fact that the Contractor does not own or lease any automobiles used in connection with performance under the Contract, on a form provided by DOCCS. If, however, during the term of the Contract, the Contractor acquires or leases any automobiles that will be used in connection with performance under the Contract, the Contractor must obtain Business Automobile Liability Insurance that meets all of the requirements of this Section and provide proof of such coverage to DOCCS in accordance with the insurance requirements of any Contract resulting from this Solicitation.

SECURUS HAS READ, AGREES AND WILL COMPLY WITH THIS REQUIREMENT.

3. Workers' Compensation Insurance and Disability Benefits Requirements

Sections 57 and 220 of the New York State Workers' Compensation Law require the heads of all municipal and state entities to ensure that businesses applying for contracts have appropriate workers' compensation and disability benefits insurance coverage.

These requirements apply to both original contracts and renewals. **Failure to provide proper proof of such coverage or a legal exemption will result in a rejection of a Bid or any contract renewal. A Bidder will not be awarded a Contract unless proof of workers' compensation and disability insurance is provided to DOCCS.** Proof of workers' compensation and disability benefits coverage, or proof of exemption must be submitted to DOCCS at the time of Bid submission, policy renewal, contract renewal, and upon request. Proof of compliance must be submitted on one of the following forms designated by the New York State Workers' Compensation Board. **An ACORD form is not acceptable proof of New York State workers' compensation or disability benefits insurance coverage.**

Proof of Compliance with Workers' Compensation Coverage Requirements:

- Form CE-200, *Certificate of Attestation for New York Entities With No Employees and Certain Out of State Entities, That New York State Workers' Compensation and/or Disability Benefits Insurance Coverage is Not Required*, which is available on the Workers' Compensation Board's website (www.wcb.ny.gov);
- Form C-105.2 (9/07), *Certificate of Workers' Compensation Insurance*, sent to DOCCS by the Contractor's insurance carrier upon request, or if coverage is provided by the New York State Insurance Fund, they will provide Form U-26.3 to DOCCS upon request from the Contractor; or
- Form SI-12, *Certificate of Workers' Compensation Self-Insurance*, available from the New York State Workers' Compensation Board's Self-Insurance Office, or

- Form GSI-105.2, *Certificate of Participation in Workers' Compensation Group Self- Insurance*, available from the Contractor's Group Self-Insurance Administrator.

Proof of Compliance with Disability Benefits Coverage Requirements:

- Form CE-200, *Certificate of Attestation for New York Entities With No Employees and Certain Out of State Entities, That New York State Workers' Compensation and/or Disability Benefits Insurance Coverage is Not Required*, which is available on the Workers' Compensation Board's website (www.wcb.ny.gov);
- Form DB-120.1, *Certificate of Disability Benefits Insurance*, sent to DOCCS by the Contractor's insurance carrier upon request; or
- Form DB-155, *Certificate of Disability Benefits Self-Insurance*, available from the New York State Workers' Compensation Board's Self-Insurance Office.

An instruction manual clarifying the New York State Workers' Compensation Law requirements is available for download at the New York State Workers' Compensation Board's website, <http://www.wcb.ny.gov>. Once on the site, click on the Employers/Businesses tab and then click on Employers' Handbook.

SECURUS HAS READ, AGREES AND WILL COMPLY WITH THIS REQUIREMENT.

8.11 Consultant Disclosure Reporting Requirements

Pursuant to New York State Finance Law, Section 163(4)(g), state agencies must require all contractors, including subcontractors, that provide consulting services for State purposes pursuant to a contract to submit an annual employment report for each such contract, such report to include for each employment category within the contract: the number of employees employed to provide services under the contract, the number of hours they work, and the total compensation under the contract for those employees. Consulting services are defined as analysis, evaluation, research, training, data processing, computer programming, engineering, environmental, health, and mental health services, accounting, auditing, paralegal, legal, or similar services.

Upon notification of award for this RFP, the selected Contractor must complete Form A, *State Consultant Services*. The completed Form A should include information for all employees that will be providing services under the contract resulting from this IFB.

The Contractor must submit Form B, *State Consultant Services Contractor's Annual Employment Report* (Attachment C), to report annual employment information required by the statute. This form captures historical information, detailing actual employment data for the most recently concluded State fiscal year (April 1 – March 31). Submit Form B to DOCCS Budget & Finance Unit, the Consultant Reporting Section of the Bureau of Contracts at OSC, and the Department of Civil Services at the addresses provided below.

Submit the completed Form B annually by May 15 for each State fiscal year (or portion thereof) the contract is in effect, as follows:

Contracting Agency: DOCCS
Supervision

NYS Department of Corrections and Community

Sandra Downey, Director Budget and
Finance 1220 Washington
Avenue
Albany, New York 12226-2050

OSC: Consultant Reporting Sections of the Bureau of Contracts

NYS Office of the State
Comptroller Bureau of
Contracts
110 State Street, Floor 11
Albany, NY 122236
Attention: Consultant Reporting

DCS:

NYS Department of Civil Service
Alfred E. Smith Office
Building Albany, NY
12239

Forms A and B as well as the instructions are found in Attachment C.

SECURUS HAS READ, AGREES AND WILL COMPLY WITH THIS REQUIREMENT.

8.12 Freedom of Information Law/Trade Secrets

During the evaluation process, the content of each bid will be held in confidence and details of any bid will not be revealed (except as may be required under the Freedom of Information Law or other State law). The Freedom of Information Law provides for an exemption from disclosure for trade secrets or information the disclosure of which would cause injury to the competitive position of commercial enterprises. This exception would be effective both during and after the evaluation process. Should you feel your firm's bid contains any such trade secrets or other confidential or proprietary information, **you must submit a request to except such information from disclosure.** Such request must be in writing, must state the reasons why the information should be accepted from disclosure and must be provided at the time of submission of the subject information. Requests for exemption of the entire contents of a bid from disclosure have generally not been found to be meritorious and are discouraged. Kindly limit any requests for exemption of information from disclosure to bona fide trade secrets or specific information, the disclosure of which would cause a substantial injury to the competitive position of your firm.

SECURUS HAS READ, AGREES AND WILL COMPLY WITH THIS REQUIREMENT.

8.13 Executive Order Number 26

Bidders should review this executive order prior to submitting proposals. You may access the executive order on the Governor's Web site: [STATEWIDE LANGUAGE ACCESS POLICY](#) In the event that translation/interpretation services are required for languages other than the Spanish language, the selected Contractor must agree to comply with any requests by DOCCS to provide documents or other assistance to allow for translation or interpretation to be conducted. Any costs associated with the translation or interpretation services will be incurred by DOCCS.

SECURUS HAS READ, AGREES AND WILL COMPLY WITH THIS REQUIREMENT.

8.14 Executive Order 38

Limits on State-Funded Administrative costs & Executive Compensation: Bidders should review Executive Order 38 and the rules and regulations prior to submitting proposals. More specifically, Bidders should review the restrictions on allowable administrative expenses, the limits on executive compensation, and the reporting requirements. It is the obligation of the selected Contractor, not the State, to determine if Executive Order 38 is applicable. In addition, the selected Contractor must include a provision in any agreement with a subcontractor or agent stating that if said subcontractor or agent is receiving State funds or State-authorized payments from the Contractor to provide program or administrative services under the Contract resulting from this RFP, the subcontractor must also comply with Executive Order 38.

All Contractors doing business with DOCCS should be familiar with Executive Order 38 and the applicable DOCCS Rules and Regulations for the executive order.

Bidders and Contractors may access the executive order using this link, executiveorder38.ny.gov, or from the DOCCS' Web site at www.doccs.ny.gov. The applicable DOCCS Rules and Regulations for the executive order are located in the 7 New York Codes, Rules, and Regulations (NYCRR) Part 513.

SECURUS HAS READ, AGREES AND WILL COMPLY WITH THIS REQUIREMENT.

8.15 Performance/Payment Bond Requirement

Prior to the commencement of performance of the work to be undertaken pursuant to the Contract, DOCCS requires the Contractor to furnish without cost to DOCCS a performance/payment bond as security for the faithful performance of the Contract in the amount of Ten Million Dollars (\$10,000,000.00), which shall be in the exact form and language of the sample bond attached as Appendix L. The surety must be authorized to do business as a surety in the State of New York, and its name must appear on the current list of sureties acceptable to the Treasury Department of the United States in effect at the time of submission of the Performance and Payment Bond to DOCCS. In addition, the aggregate underwriting limitations on any one risk as set forth in the aforementioned list of approved Treasury Department sureties shall equal or exceed the penal sum of the Performance and Payment Bond.

SECURUS HAS READ, AGREES AND WILL COMPLY WITH THIS REQUIREMENT.

8.16 Licensed or Patented Components

The vendor must identify any software that is not owned by the vendor or any patented or proprietary components and provide details on the vendor's authorization to use and resell such components including duration of agreement and source.

SECURUS HAS READ, AGREES AND WILL COMPLY WITH THIS REQUIREMENT.

8.17 Perpetual License

The vendor shall provide to DOCCS a perpetual non-exclusive license for all software utilized in the delivery of services under this contract. The license shall continue after the termination of the contract, but DOCCS shall not be entitled to free upgrades or support after contract termination.

SECURUS HAS READ, AGREES AND WILL COMPLY WITH THIS REQUIREMENT.

8.18 Escrow of Software

Upon award the vendor shall escrow all software and routines, documentation and operational information necessary for the full production operation of the ITS with an escrow agent approved by DOCCS. The escrow agreement shall specify that the software source and production code and all related material shall be provided to DOCCS at no cost in the event that the vendor is unable or unwilling to meet its obligations under this contract. In such event DOCCS shall be deemed to have full ownership rights to the software and materials. The vendor shall at all times assure that the escrowed software and materials are for the current DOCCS' production system.

SECURUS HAS READ, AGREES AND WILL COMPLY WITH THIS REQUIREMENT.

8.19 Breach of Services

In the event of any material breach of service by the contractor, the Department shall give written notice specifying the material breach. If such written notice of material breach is given and the provider does not correct the breach to DOCCS satisfaction within thirty (30) days after receipt of the written notice, DOCCS shall have the right to unilaterally and immediately terminate the Agreement and seek a replacement provider in order to maintain telephone service to the inmates without penalty to DOCCS.

SECURUS HAS READ, AGREES AND WILL COMPLY WITH THIS REQUIREMENT.

8.20 General Requirements

The Bidder agrees to

1. adhere to all State and Federal laws and regulations in connection with the contract; and,
2. at a minimum, notify DOCCS of any changes in the legal status or principal ownership of the company, forty five (45) days in advance of said change.

The Bidder agrees that

3. in any contract resulting from this RFP, it shall be completely responsible for its work, including any damages or breakdowns caused by its failure to take appropriate action; and,
4. any contract resulting from this RFP may not be assigned, transferred, conveyed or the work subcontracted without the prior written consent of the Commissioner of DOCCS.
5. For reasons of safety and public policy, in any contract resulting from this RFP, the use of illegal drugs and/or alcoholic beverages by the Contractor or its personnel shall not be permitted while performing any phase of the work herein specified.
6. For purposes of any contract resulting from this RFP, the State will not be liable for any expense incurred by the Contractor for any parking fees or as a consequence of any traffic infraction or parking violations attributable to employees of the Contractor.
7. The Commissioner's interpretation of specifications shall be final and binding upon the Contractor.
8. The Commissioner of DOCCS will make no allowance or concession to the bidder for any alleged misunderstanding because of quantity, quality, character, location or other conditions.
9. Should it appear that there is a real or apparent discrepancy between different sections of specifications concerning the nature, quality or extent of work to be furnished, it shall be assumed that the bidder has based its bid on the more expensive option. Final decision will rest with the Commissioner of DOCCS.
10. **Inspection** – For purposes of any contract resulting from this RFP, the quality of service is subject to inspection and may be made at any reasonable time by the State of New York. Should it be found that quality of services being performed is not satisfactory and that the requirements of the specifications are not being met, the Commissioner of DOCCS may terminate the contract and employ another contractor to fulfill the requirements of the contract. The existing Contractor shall be liable to the State of New York for costs incurred on account thereof.
11. **Stop Work Order** - The Commissioner of DOCCS reserves the right to stop the work covered by this RFP and any contract(s) resulting therefrom at any time that it is deemed the successful Bidder is unable or incapable of performing the work to the state's satisfaction. In the event of such stopping, DOCCS shall have the right to arrange for the completion of the work in such manner as it may deem advisable and if the cost thereof exceeds the amount of the bid, the successful Bidder shall be liable to the State of New York for any such costs on account thereof. In the event that DOCCS issues a stop work order for the work as provided herein, the Contractor shall have ten (10) working days to respond thereto before any such stop work order shall become effective.
12. It is the Contractor's responsibility to maintain the equipment and materials provided for the work consistent with applicable safety regulations, health codes, and all policies or directives established by DOCCS. Failure to account for all equipment, materials, and tools or to report missing equipment, materials, and tools immediately may result in the termination of the contract.
13. DOCCS reserves the right to reject and bar from the facility any employee hired by the Contractor.

SECURUS HAS READ, AGREES AND WILL COMPLY WITH THIS REQUIREMENT.

8.21 Equipment and Licenses Upon Termination

Upon contract termination all installed equipment, wiring, servers, communications components and related elements shall become the property of DOCCS without further cost to DOCCS. This shall explicitly include a perpetual license for all installed software. DOCCS shall own all elements required to continue the operation of a fully functional production system. The contractor shall provide all ITS services including but not limited to call recording and customer service and billing required by this contract for ninety (90) days after the contract termination date.

8.21.1 Agency Termination

DOCCS reserves the right to cancel the complete contract or any part thereof, at any time, giving the Contractor thirty (30) days written notice for convenience or unavailability of funds. If in the judgment of DOCCS, the Contractor fails or refuses to perform the work in accordance with the contract, DOCCS may terminate the contract immediately by written notice for cause.

Upon written notice to the Contractor, and a reasonable opportunity to be heard with appropriate DOCCS' officials or staff, the contract may be terminated by the DOCCS' Commissioner or his designee at the Contractor's expense where the Contractor is determined by the DOCCS Commissioner or his designee to be non-responsible. In such event, the DOCCS Commissioner or his designee may complete the contractual requirements in any manner he may deem advisable and pursue available legal or equitable remedies for breach.

DOCCS may, upon a thirty (30) day notice, terminate the contract resulting from this RFP in the event of the awarded Bidder's failure to comply with any of the bid's requirements unless the awarded Bidder obtained a waiver of the requirement.

In addition, DOCCS may also terminate any contract resulting from this RFP upon ten (10) days written notice if the Contractor makes any arrangement or assignment for the benefit of creditors.

Furthermore, DOCCS shall have the right, in its sole discretion, at any time to terminate a contract resulting from this RFP, or any unit portion thereof, with or without cause, by giving thirty (30) days written notice of termination to the Contractor.

Any termination by DOCCS under this Section shall in no event constitute or be deemed a breach of any contract resulting from this RFP and no liability shall be incurred by or arise against DOCCS, its agents and employees therefore for lost profits or any other damages.

SECURUS HAS READ, AGREES AND WILL COMPLY WITH THIS REQUIREMENT.

8.21.2 Procurement Lobbying Termination

DOCCS reserves the right to terminate this contract in the event it is found that the certification filed by the Offeror in accordance with New York State Finance Law §139-k was intentionally false or intentionally incomplete. Upon such finding, DOCCS may exercise its termination right by providing written notification to the Offeror in accordance with the written notification terms of this contract.

SECURUS HAS READ, AGREES AND WILL COMPLY WITH THIS REQUIREMENT.

8.22 Contract Terms

1. All provisions and requirements of Appendix A, *Standard Clauses for New York State Contracts*, which is attached hereto and forms a part hereof, will be incorporated into any contract resulting from this RFP, and will be binding upon the parties to such contract.
2. All provisions and requirements that are attached hereto and form a part hereof, will be incorporated into any contract resulting from this RFP, and will be binding upon the parties to such contract.
3. It is stipulated and agreed by the parties that the law of the State of New York shall solely and in all respects govern with relation to any dispute, litigation, or interpretation arising out of or connected with any contract resulting from this RFP.
4. Any contract resulting from this RFP shall not be deemed executed, valid or binding unless and until approved in writing by the Attorney General and the Comptroller of the State of New York.

SECURUS HAS READ, AGREES AND WILL COMPLY WITH THIS REQUIREMENT.

8.23 Nondisclosure Agreement

Upon contract award, the selected vendor will be required to sign the non-disclosure agreement in Appendix I.

SECURUS HAS READ, AGREES AND WILL COMPLY WITH THIS REQUIREMENT.

8.24 Contract Provisions

The entire RFP plus clarification questions and answers as well as the selected vendor's proposal shall be included in the final contract.

SECURUS HAS READ, AGREES AND WILL COMPLY WITH THIS REQUIREMENT.

8.25 Potential Annual Revenue Payments

It is understood between the parties that, in the event a change is made to the law in New York State with respect to the permissible use of telephone revenue, the parties will meet in a good faith effort to negotiate a possible amendment regarding phone rates that are charged, which would be consistent with the change in such law. It is further understood that if an amendment is negotiated and agreed to, it would also have to be approved by all necessary governmental entities, including, but not limited to, the Office of the State Comptroller, and that said agreement would also have to meet any governmental regulatory restrictions that may apply.

SECURUS HAS READ, AGREES AND WILL COMPLY WITH THIS REQUIREMENT.

Moreover, in the event of such a change as stipulated above, the parties will have an understanding that the revenue set-aside from the use of the inmate telephone system will not exceed \$ 2 million.

SECURUS HAS READ, AGREES AND WILL COMPLY WITH THIS REQUIREMENT.

8.26 Inmate Secure Messaging Option

DOCCS is exploring the possibility of offering inmates the ability to communicate with those individuals listed on the inmates' call lists, using secure messaging and utilizing the infrastructure as described in the successful bidder's proposal response to this RFP. If DOCCS decides to implement this feature in the future, with a 90-day notice to the contractor selected, the following information will be applicable:

- The vendor will provide the ability for inmates to access and utilize secure messaging, including the sending and receiving of secure messages to those individuals on the inmates' call lists.
- The vendor will identify and detail any costs associated with accessing, sending, or receiving secure messages, including any additional surcharges or handling fees assessed by the vendor that will be charged to the friends and family sending the secure messages. The cost to send or receive secure messages must be less than the cost to send an equivalent written letter.
- The ability to conduct investigative analysis of the secure messages, including, but not limited to, key word searches, analytics, and investigative software, which shall be described in detail by the vendor.
- The vendor's proposed costs will conform to all other applicable rules within the contents of the resulting contract and this RFP, including all investigative, analytic and reporting capabilities. Prior to implementation of secure messaging, the vendor will provide information to DOCCS regarding all aspects of this additional service as follows:
 - A detailed plan for inmates to access secure messaging, including those in restricted or specialized housing.
 - Ability to send and receive secure messaging via a tablet or third party device.
 - Ability to perform translation of foreign languages secure messages.
 - A mechanism to securely monitor and review secure messages before they are sent or received by the inmate.

Any amendment to the original contract agreement resulting from this solicitation will be subject to approval by the Office of the Attorney General and the Office of the State Comptroller.

SECURUS HAS READ, AGREES AND WILL COMPLY WITH THIS REQUIREMENT.

END OF SECTION 8: CONTRACTUAL ISSUES

9 Administrative Procedures

9.1 Communication with DOCCS

All inquiries concerning this RFP must be addressed in writing to the DOCCS' designated contact as specified in [Section 1.6](#). DOCCS' employees should not be contacted regarding this RFP except as authorized by the DOCCS' designated contact person identified in Section 1.6. Any unauthorized contact shall constitute grounds for disqualification and rejection of the bidder's proposal.

SECURUS HAS READ, AGREES AND WILL COMPLY WITH THIS REQUIREMENT.

9.2 Procurement Rights

The state of New York reserves the rights for the following:

1. Reject any and all bids received in response to this Solicitation.
2. Withdraw the RFP at any time, at the agency's sole discretion.
3. Disqualify a bidder from receiving the award if the bidder, or anyone in the bidder's employ, has previously failed to perform satisfactorily in connections with public bidding or contracts.
4. Correct bidders' mathematical errors and waive or modify other minor irregularities in bids received, after prior notification to the bidder.
5. Adjust any bidder's expected costs of the bid price based on a determination of the evaluation committee that the selection of the said bidder will cause the state to incur additional costs.
6. Utilize any and all ideas submitted in the bids received.
7. Negotiate with bidders responding to this solicitation within the solicitation requirements to serve the best interests of the state.
8. Begin contract negotiations with another bidding contractor to serve the best interests of the state should DOCCS be unsuccessful negotiating a contract with the selected contractor within 21 days of the selection notification.
9. Waive any nonmaterial requirement not met by all bidders.
10. Not make an award under this solicitation.
11. Make an award under this solicitation in whole or in part.
12. Make multiple contract awards pursuant to the solicitation.
13. Have any service completed via separate competitive bid or other means, as determined to be in the best interest of the state.
14. Seek clarifications of bids.
15. If two or more offers are found to be substantially equivalent, the Commissioner of DOCCS, at his sole discretion, will determine award.

SECURUS HAS READ, AGREES AND WILL COMPLY WITH THIS REQUIREMENT.

9.3 Proposal Format, Packaging, and Submission Instructions

Package the Technical, Cost, and Diversity Practices proposal components separately. All components should be clearly labeled with *RFP 2016-02*, the component name, and the bidder's name.

- a. Submit two (2) originals of the completed Technical Proposal, and ten (10) copies for a total of twelve (12) Technical Proposals including Appendix K, *Proposal Response Forms*, and required documents. The narrative responses must correspond with the relative sections/paragraphs of the RFP. An original signature should be applied to each original and copy. Include one electronic copy in PDF format of the technical proposal on an electronic medium.
- b. Submit two (2) original signed Cost Proposal Forms and attachments in a separate sealed and labeled envelope with the narrative responses for Section 7 and the documentation to substantiate financial stability.
- c. Submit two (2) original signed *Diversity Practices Questionnaires* with attached sheets in a separate sealed and labeled envelope.
- d. Submit proposals so that they will be in the possession of the DOCCS' contact person by 3:00 PM EDT on the day indicated in [Section 1.7](#). It is the sole responsibility of bidders to insure the proposals are received by the bid closing date and time.
- e. It shall be the responsibility of each bidder to see that its material is appropriately contained in some physical form that best guards against the loss of property in transit or in handling by DOCCS once received.
- f. Submit the proposal so that updated pages can be easily incorporated into the original.
- g. Place the official name of the firm submitting the proposal so that it appears on the outside front cover of each binder and/or envelope with the name of the designated contact person(s) as provided in [Section 1.6](#) of the RFP. Every copy of the proposal should have each major section separated with index tabs to identify the major sections of the proposal so that the proposal corresponds with the sections in the table of contents.
- h. Complete the forms in Appendix K, *Proposal Response Forms*, ensuring each box is checked to indicate that the bidder has read and agreed to the requirements in each of the sections of the RFP and has included the required supporting documentation with its proposals. The completed set of Response Forms shall be included in Technical Proposal component of the bidder's proposal with the narrative text the bidder deems relevant.
- i. Include all required substantiating documentation and responses as specified in the RFP and the Response Forms for Sections 2 through 7 of the proposal. The substantiating documentation and responses shall cross reference the associated paragraph number of the RFP. It is not necessary to repeat each paragraph text as it appears in the RFP, it is only necessary to ensure that the Proposal Response form is properly completed and the responses and required documentation are cross referenced to the appropriate RFP paragraph number.
- j. Identify all supporting documentation required in the RFP. DOCCS will not accept links to external websites in place of documentation. If the required documentation does not lend itself to being bound in the format specified, uniquely identify the documentation and reference it accordingly.
- k. This Request for Proposals is comprised of the RFP title page and *Notice to Bidders* page, the table of contents, the pages numbered sequentially in the footer ending with page number 58 and all of the Appendices and Attachments. If the bidder determines that a page(s) is missing or otherwise defective, the bidder should contact DOCCS

immediately so that a corrected copy can be issued to the bidder. Bidders must ensure that all pages have been included in the RFP downloaded from the NYS Contract Reporter or DOCCS' Web site.

- I. Only those Bidders who furnish all required information will be considered.

Submit all required bid documents including signed bid addenda if any by the Proposal Due Date and time (Section 1.7), to the following address:

Proposal Submission for RFP2016-02

NYS Department of Corrections & Community
Supervision Division of Support Operations /
Contract Procurement Unit Attention: Velma Berry

550 Broadway

Menands, NY 12204

DOCCS will not consider emailed or faxed bid submissions.

**COST PROPOSALS WILL NOT BE OPENED UNTIL THE TECHNICAL
EVALUATION HAS BEEN COMPLETED.**

SECURUS HAS READ, AGREES AND WILL COMPLY WITH THIS REQUIREMENT.

9.3.1 Proposal Content

Entire proposal:

1. Completed and signed *Application Cover Sheet* and *Individual, Corporation, Partnership, or LLC Acknowledgment* (within Attachment C). Return as cover sheet and second page for the Technical Proposal.
2. *Procurement Lobbying Certification* (within Attachment C).
3. Appendix K, *Proposal Response Forms*, and the Technical Response Narrative: two (2) originals, plus ten (10) copies, plus one electronic copy in PDF format on an electronic medium.
4. Appendix H, *Cost Proposal Form*: two (2) original signed *Cost Proposal Forms* with attachments, narratives for Section 7, and documentation to substantiate financial stability submitted in a separate sealed and labeled envelope.
5. Appendix M, *Diversity Practices Questionnaire*: two (2) original completed, signed, and notarized questionnaires. Follow the instructions on the questionnaire, complete the questions, include the attached sheets as instructed, and submit the completed questionnaires (plus documents) in a separate sealed and labeled envelope.

SECURUS HAS READ, AGREES AND WILL COMPLY WITH THIS REQUIREMENT.

9.3.2 Other legal documents (required but not subject to pass/fail disqualification):

See Attachment C, *Bidders' Checklist and Required Documents*, due with the technical proposal or as a contingency for the tentative award:

- Online (or hard copy) *Vendor Responsibility Questionnaire* (Appendix E)
- MWBE and EEO Required forms (Appendix C)
- *Encouraging Use of NYS Businesses in Contract Performance* (within Attachment C)
- Vendor Reference Form (Appendix F)
- Staff Qualification Form (Appendix G)
- *Non-Disclosure Agreement* (Appendix I)
- *Performance/Payment Bond* (Appendix L)
- Form A, *State Consultant Services – Contractor's Planned Employment* (within Attachment C)
- Form ST-220-CA (Section 8.4)
- Verification Workers' Compensation and NYS Disability Coverage (Section 8.10)

SECURUS HAS READ, AGREES AND WILL COMPLY WITH THIS REQUIREMENT.

9.3.3 Technical Proposal

The Technical Proposal shall be defined as the bidder's narrative responses to the entire RFP as outlined in Appendix K, the completed and signed Appendix K, and all requested attachments and documentation. The Technical Response shall contain the following:

- A. The completed Proposal Response Forms (Appendix K) signed by the bidder's representative having the authority to commit the company to the obligations set forth in the proposal.
- B. Narrative responses to all requirements and issues in the RFP cross referenced to the sections and paragraph numbers in the RFP.
- C. Requested documentation.
- D. All forms included or cited in the RFP completed as required (Attachment C).

Read and follow the instructions for Appendix K before completing the form and the technical proposal narrative. Prepare the technical proposal narrative identifying the section/subsection and paragraph with which your responses correspond.

SECURUS HAS READ, AGREES AND WILL COMPLY WITH THIS REQUIREMENT.

9.3.4 Cost Proposal

The Cost Proposal shall be defined as the completed Cost Proposal Form (Appendix H) showing the costs for all Contract Services requested herein; responses cross referenced to the subsections and paragraphs in Section 7 of the RFP; and documentation to substantiate the bidder's financial stability (Section 7.4). The costs shall be considered all inclusive. The Cost Proposal Form is to be packaged in a **separate envelope** labeled as *RFP 2016-02 Cost Proposal Form*. Include the bidder's

name on the envelope. In the event the bidder is disqualified during the technical evaluation phase, the Cost Proposals will not be considered. The Cost Proposal Form must be signed by the bidder's representative having the authority to commit the company to the obligations set forth in the proposal.

SECURUS HAS READ, AGREES AND WILL COMPLY WITH THIS REQUIREMENT.

9.3.5 Diversity Practices Questionnaire

Bidders must complete Appendix M, *Diversity Practices Questionnaire*, as described in this RFP herein. The bidders' responses will be evaluated using a separate predetermined rating scale. The resulting scores assigned for diversity practice will be worth up to 2% of the technical score. The Diversity Practices response is to be packaged in a **separate envelope** labeled as *RFP 2016-02 Diversity Practices Questionnaire*.

SECURUS HAS READ, AGREES AND WILL COMPLY WITH THIS REQUIREMENT.

9.4 Proposal Evaluation

Bidders' proposals will be evaluated in an objective, comprehensive manner. The evaluation criteria will be applied uniformly and equally, ensuring that each qualified bidder has an opportunity to be fairly considered.

SECURUS HAS READ, AGREES AND WILL COMPLY WITH THIS REQUIREMENT.

The process used to evaluate the proposals will proceed through the following phases:

9.4.1 Mandatory Requirements (Pass/Fail)

The proposals will be reviewed to determine that the bidder has met **all** mandatory requirements. Failure to meet any mandatory requirement will disqualify the bidder from further consideration.

New York State will not be a test site for unproven technology. For all technology proposed, your references must include at least two sites where this technology has been in service as an integrated part of the inmate phone system for at least six (6) months. An onsite or real-time demonstration of the technology must be provided prior to finalization of the scoring for this procurement.

SECURUS HAS READ, AGREES AND WILL COMPLY WITH THIS REQUIREMENT.

9.4.2 Technical Evaluation (95 points)

The Technical Evaluation team will evaluate and rate the bidders' proposals using a rating scale and a predetermined scoring tool and award points for responses to the sections/subsections as indicated in the Appendix K. Responses to Appendix M, *Diversity Practices Questionnaire*, will be evaluated separately using a predetermined scale. The final Diversity Practices score for each bidder will be included in the Technical Evaluation score. Each bidder's technical proposal, as defined in Section 9.3.3, will be evaluated in three categories:

- A. Delivery of Services
- B. Telecommunication Capabilities
- C. Business Operations Capabilities

SECURUS HAS READ, AGREES AND WILL COMPLY WITH THIS REQUIREMENT.

9.4.3 Cost Evaluation (5 points)

The Cost Evaluation will include the narrative response for Section 7.3 submitted with Appendix H, *Proposal Cost Form*, and the total requested Account Fees in Appendix H. The cost score will be calculated using a predetermined rating scale to evaluate responses to 7.3 and by assigning the highest possible score to the proposal with the lowest total account fees. All bidders' total account fees will be prorated by comparing it to the lowest total proposed account fees. Bidders should include the requested Financial Statements in Section 7.4 with their Cost Proposal submissions.

SECURUS HAS READ, AGREES AND WILL COMPLY WITH THIS REQUIREMENT.

9.4.4 Composite Scores

If proposals satisfy the Mandatory Requirements (pass/fail), the points awarded for the Cost Evaluation and Technical Evaluation categories will be combined to arrive at a composite score. The proposals will then be ranked from highest to lowest score.

In accordance with State Finance Law §163(10)(a), when price and other factors are found to be substantially equivalent, the determination of the commissioner or agency head to award a contract to one or more of such bidders shall be final. The basis for determining the award shall be documented in the procurement record.

SECURUS HAS READ, AGREES AND WILL COMPLY WITH THIS REQUIREMENT.

9.4.5 Debriefings

Bidders will be accorded fair and equal treatment with respect to their opportunity for debriefing. Prior to the final contract award, DOCCS shall, upon request, provide a debriefing which would be limited to review of the requesting bidder's proposal. After the final contract award, DOCCS shall, upon request, provide a debriefing to any bidder that responded to the RFP, regarding the reason that the bid submitted by the unsuccessful bidder was not selected for a contract award. The post award debriefing should be requested by the bidder within thirty (30) days of contract approval as posted on the OSC website (web address below).

<http://www.openbooknewyork.com/>

SECURUS HAS READ, AGREES AND WILL COMPLY WITH THIS REQUIREMENT.

END OF SECTION 9: ADMINISTRATIVE PROCEDURES

REQUESTED DOCUMENTATION

Requested Documentation

Sample Call Detail Reports

Additional Information Reference – 3.15 Reporting

SECURUS TECHNOLOGIES

Secure Call Platform User Interface Sample Reports

SECURUS
Secure Call Platform

connecting users

Authorized users enter username and password for anytime, anywhere access.

Log-In
Username
Password
Login
[Forgot Your Password?](#)

Important Information
There are currently no alerts available.

Off The Wire
04.06.2012
Securus Technologies, Inc. Announces Its Video Visitation Services to the Corrections Industry
04.04.2012
Securus Technologies, Inc. Adds New Payment Locations with MoneyGram
04.02.2012
Securus Announces Availability of JIG Technologies ? Investigator Pro?

Products & Services
Automated Information Services
Securus Video Visitation
Prepaid Calling Cards - Vending Machines
Inmate Debit Account
Secure Instant Mail

[Click Here To Access Facility Portal](#)

Copyright © 2011 SecurUS Technologies, Inc. All Rights Reserved

SECURUS TECHNOLOGIES

Secure Call Platform User Interface Sample Reports

Selected Sample SCP Reports

- [Call Detail Search Screen](#)
- [Call Detail Results Screen](#)
- [Three Way Call Detection Report](#)
- [Call Frequency Report](#)
- [Custody Account Call Usage Report](#)
- [Call Tracker Report](#)
- [Hourly Usage](#)
- [Covert Alert Report](#)
- [Officer Check In Report](#)
- [PAN Frequency and Detail Report](#)
- [PAN Management Report](#)
- [SCP Debit Report](#)
- [Voice Biometric Status Report](#)
- [Voice Biometrics Frequency of Failure Report](#)
- [Crime Tip Report](#)
- [Informant Line Report](#)
- [Emergency Call Report](#)
- [Word Spotting Search Report](#)
- [Comprehensive System Change Log](#)
- [Management Change Log](#)
- [Custody Account Change Log](#)
- [PAN Entry Change Log](#)
- [Phone Number Change Log](#)
- [User Management Change Log](#)
- [Security Template Change Log](#)
- [System Access Report](#)
- [Recording Log](#)
- [Scan Patrol Log](#)

8/5/2013

Proprietary and Confidential

2

Three Way Call Report

Secure Call Platform

HOME SYSTEM MONITOR TOOLS ADMIN FACILITY PORTAL

MANAGEMENT LEVEL: Family

Site: Securus Demo Site Phone Group: All Phone Groups Phone: All Phones

Call Detail Records Search

FILL IN SEARCH CRITERIA (* Indicates Required Fields)

(Use * for wild card / partial searches)

Country Code: Dated Number: Destination Zone: -- ALL -- International:

Custody Account #: PBI #: Prepaid Account #: Watched:

First Name: Last Name: Private:

Termination Category: -- ALL -- Blocked Reason: -- ALL -- 3-Way:

Call Type: -- ALL -- Call Status: -- ALL -- Voice Biometrics:

Date Criteria: Date/Time Range Results Per Page: 100 Test Call:

Start: 02/01/2011 00:00:00 End: 04/26/2011 23:59:59 BCF:

Search EXCEL PDF CSV Reset

2 Results PAGE 1 OF 1

SITE	POST LOC	DIALED #	DIRT	END	ACT #	PREFID	NAME	CALL TYPE	CALL STATUS	TEST CRT	BLOCKED REASON	CALL PROPERTIES
Securus Demo Site	ja test-4	8002279191	02-16-2011 03:11:47	02-16-2011 03:12:19	32 (A)	7890	Heleen Huynh	Coordinator	complete	Called party hangup		Language: English 3-Way
Securus Demo Site	Test Port 3	9729801052	03-23-2011 02:30:19	03-23-2011 02:31:11	32 (A)	99799	Barry Davis	Person Call	complete	Called party hangup		Language: English 3-Way

Apply a number of different actions to the call record.

Call is flagged as 3-Way in SCP.

3-Way Search Criteria

Customizable Search Engine

Investigators can run a comprehensive 3-way report to display calls that have been flagged as having 3-way activity. They can also use additional features to understand what happened to the call, make notes on the call, (and much more) – to uncover why the inmate attempted to “hide” the number. SCP can then be used to correct the behavior or flag the inmate or dialed number for further investigation.

Terms and Conditions © 2011 Securus Technologies, Inc. All Rights Reserved.

Sample Call Frequency Report

Call Frequency Report – an essential investigative report. The report allows users to look up phone numbers in the system that have been called a certain number of times within a given time frame by using criteria such as threshold (of the number of times a number was called), international, watched, private, termination category, call type, call status, and date range.

Secure Call Platform

Facility Routing Number: 99001

HOME SYSTEM MONITOR TOOLS ADMIN FACILITY PORTAL

MANAGEMENT LEVEL: Family

Site: Securus Demo Site Phone Group: All Phone Groups Phone: All Phones

Call Frequency Search

FILL IN SEARCH CRITERIA (* Indicates Required Fields)

(Use * for wild card / partial searches)

Threshold: 2 Call Status: -- ALL -- International:

Termination Category: -- ALL -- Call Type: -- ALL -- Watched:

Start: 01/15/2011 End: 04/19/2011 Private:

Search EXCEL PDF CSV Reset

20 Results PAGE 1 OF 2

SITE	DIALED #	FREQUENCY
Securus Demo Site	(1) 9722770311	25
Securus Demo Site	(1) 9722770556	16
Securus Demo Site	(1) 9722770596	10
Securus Demo Site	(1) 9722770300	9
Securus Demo Site	(1) 5743127016	6
Securus Demo Site	(1) 9722770305	5
Securus Demo Site	(1) 2144981124	4
Securus Demo Site	(1) 6128340463	4
Securus Demo Site	(1) 2146182718	4
Securus Demo Site	(1) 9738907824	3

Enter a threshold for the number of times a number was called to initiate the report. Select date range and other criteria to narrow the results.

Call Frequency results display each dialed number meeting or exceeding the defined threshold. By clicking on a frequency amount, all call detail information for the calls are displayed.

Sample Custody Account Call Usage Report

Custody Account Call Usage Report – allows users to view how much time an inmate spends on the phone for a selected period and whether or not they speak to the called party – right from an inmate’s Custody Account record. If required, full call detail reports are also available by entering an inmate’s name, PIN, or custody account number in the Call Detail Report.

Secure Call Platform Facility Routing Number: 99001

MANAGEMENT LEVEL: Facility: Securus Demo Site, Site: All Sites, Phone Group: All Phone Groups, Phone: All Phones

Custody Accounts
Returns to Account List

GENERAL ACCOUNT INFORMATION (* Indicates Required Fields)

Account #: 990009	Gender:	Activation Date:	Suspended:	Call Schedule:
Name: Adam C Edwards	Race:	Booking Date:	Start Date:	None Selected
DOB:	Language Pref.: NONE	Release Date:	End Date:	Default
SSN:	Housing Unit:	Alert Level:	Word Spotting:	Max Call Dur.: 0 minutes
Status: ACTIVE	PIN #: 225500	Private (on Visitation): NO	First Calls Free:	Calling Restrictions: None Selected
			Virtual Group:	None Selected

Misc | PAN | Notes | Voice Biometrics | **Calling Usage** | Debit

CALLING USAGE SEARCH
Start: 03/28/2011 00:00:00 End: 04/28/2011 23:59:59
Search Reset

CALLING USAGE REPORT
Private calls are included in usage, but may not be included with calling restrictions.

	ATTEMPTED	CONNECTED	ACCEPTED	DONES	BLOCKED	RECORDS	MINUTES
DEBIT/TRUST FUND (Non-Private)	3	2	1	0	0	103	215
COLLECT (Non-Private)	10	0	0	1	1	0	0.0
FREE (Non-Private)	1	1	0	0	0	0	0.0
COMMISSARY IVR (Non-Private)	2	1	0	0	0	4	0.07
INSTANT POFPC2 (Non-Private)	1	1	0	0	0	4	0.07
Total Calls (per Call Type)	23	11	1	1	1		
Total Accepted Calls (All):	1				Total Usage(All): 137 (Sec.) (2.29 (Min.)		
Total Accepted Calls (Excluding Private Calls):	1				Total Usage (Excluding Private Calls): 137 (Sec.) (2.29 (Min.)		

8/5/2013 Proprietary and Confidential 7

Sample Call Tracker Report

Call Tracker Report – an investigative report that allows users to track CDR notes (notes made by themselves or other investigators for a specific inmate call). Users can also export the report results to Excel PDF, and CSV file formats.

Secure Call Platform

MANAGEMENT LEVEL: Facility: Securus Demo Site, Site: All Sites, Phone Group: All Phone Groups, Phone: All Phones

Call Tracker Search
FILL IN SEARCH CRITERIA (* Indicates Required Fields)

(Use * for wild card / partial searches)

Not Shared: Tracking #: _____ First Name: _____ Last Name: _____
Custody Account #: _____ PIN #: _____ Dialed Number: _____
Notes: _____
Start Date/Time: 05/19/2010 End Date/Time: 04/19/2011 Results Per Page: 10

Search EXCEL PDF CSV Reset

2 Results PAGE 1 OF 1

CDR #	TRACKING #	TRACKER NAME	DATE/TIME	ACCA#PIN	NOTE
		Dee Smith	9722770596	0343	share all
	5272010	Huong Allen	9722770596	5252010	This is Huong test

8/5/2013 Proprietary and Confidential 8

Sample Hourly Usage Report

Secure Call Platform Facility Routing Number: 99001

HOME SYSTEM MONITOR TOOLS ADMIN FACILITY PORTAL

MANAGEMENT LEVEL: Security, Site: Securus Demo Site, Phone Group: All Phone Groups, Phone: All Phones

Hourly Usage Report

FILL IN SEARCH CRITERIA (* Indicates Required Fields)

Call Status: Complete, International: Watched: Private:

Date Criteria: Date/Time Range (Phone Date Range Search Criteria is restricted to 1 week)
 Start: 04/26/2011 00:00:00, End: 04/26/2011 23:59:59

Search PDF Reset

Results

Hour of Day	# Calls
00:00	3
01:00	20
02:00	24
03:00	28
04:00	29
05:00	15
06:00	3
07:00	1
08:00	3
09:00	1
10:00	4
11:00	7
12:00	7
13:00	3
14:00	1
15:00	2
16:00	2
17:00	7
18:00	3
19:00	3
20:00	3
21:00	2
22:00	3
23:00	3

Hourly Usage Report – is a valuable administrative report that displays the number of phone calls that have taken place on a given date within a specific time range. Search criteria includes international, watched, private, call status, and date/time.

Sample Covert Alert CDR Report

SCP's **Covert Alert Feature** - is a sophisticated investigative tool providing a live, call-forwarding feature for dialed numbers, phones, or PINs that are under surveillance by an investigative unit. This feature enables authorized personnel to monitor a call—undetected—from any designated location while the call is in progress and even "barge into" the call if necessary. **Covert Alert Report** - shows investigators the triggered Covert Alerts by useful criteria such as date/time, PIN, Alertee name/number, inmate name, dialed number, call status, and termination category. Reports can be exported into Excel, PDV, and CSV formats.

Secure Call Platform

HOME SYSTEM MONITOR TOOLS ADMIN FACILITY PORTAL

MANAGEMENT LEVEL: Security, Site: Securus Demo Site, Phone Group: All Phone Groups, Phone: All Phones

Covert Alert Call Detail Records Search

FILL IN SEARCH CRITERIA (* Indicates Required Fields)

Alertee Country Code: [], Alertee Dialed (Number): [], Alertee First Name: [], Alertee Last Name: []
 Country Code: [], Dialed Number: [], Custody Account #: [], PIN #: []
 First Name: [], Last Name: []
 Termination Category: [ALL], Call Status: [ALL]
 Date Criteria: Date/Time Range, Start: 05-01-2010 00:00:00, End: 04/19/2011 23:59:59

Search EXCEL PDF CSV Reset

17 Results PAGE 1 OF 2

SITE	PORT LOC	ALERTEE DIALED #	ALERTEE NAME	TERM CAT	START	END	DALED #	ACCT #PIN	NAME	CALL STATUS	PIN ACCEPT
Securus Demo Site	LP 10	2145664417	dee dee	No Investigator Acceptance	05-25-2010 16:33:31	05-25-2010 16:34:12	41	9722770591 2508	dee qa	complete	
Securus Demo Site	LP 10	2145664417	dee dee	Parent Call Ended	05-25-2010 18:14:02	05-25-2010 18:14:17	15	9722770591 2508	dee qa	complete	
Securus Demo Site	LP 9	2145664417	dee dee	No Investigator Acceptance	05-27-2010 13:15:33	05-27-2010 13:16:24	51	9722770596 2508	dee qa	complete	
Securus Demo Site	je test 4	2143345467	James Rogers	No Investigator Acceptance	05-28-2010 10:13:23	05-28-2010 10:14:12	49	9723659243 8899	Helen Huynh	complete	
Securus Demo Site	je test 4	2143345467	James Rogers	Covert Alert Error	05-28-2010 11:04:06	05-28-2010 11:06:38	152	9723659243 8899	Helen Huynh	incomplete	

Covert Alert report results display critical information about each triggered alert such as who was alerted, what happened, call status, call start and end, duration, dialed number and more. By clicking the icon to the left of each record, users can display full call detail information for each call. SCP's Covert Alert feature and reports have assisted in many criminal investigations throughout the country.

Sample Officer Check-In Report

Officer Check-In Report – is a valuable administrative report showing users when officers have "checked-in" at different phones and select and listen to any messages they have left.

Secure Call Platform Facility Routing Number: 99001

HOME SYSTEM MONITOR TOOLS ADMIN FACILITY PORTAL

MANAGEMENT LEVEL

Facility: Securus Demo Site Site: All Sites Phone Group: All Phone Groups Phone: All Phones

Officer Check In Messages Results

FILL IN SEARCH CRITERIA (* Indicates Required Fields)

Account#: [] PIN: [] Officer ID: [] User Name: []

First Name: [] Last Name: [] Call Status: Complete

Results per page: 10

Start: 01/19/2010 00:00:00 End: 04/19/2011 23:59:59

Search Reset

12 Results PAGE 1 OF 2

SITE	PHONE LOC	NAME	USERNAME	ACCOUNT # / PIN	OFFICER ID	DUR	CALL STATUS	MESSAGE
Securus Demo Site	LP 7	Ken Burns	kburns	POC1123 5555	3838383	23 (s) 0.33(m)	complete	03-03-2010 10:11:43
Securus Demo Site	LP 7	Ken Burns	kburns	POC1123 5555	3838383	20 (s) 0.33(m)	complete	03-03-2010 17:03:38
Securus Demo Site	LP 7	Abe Smith		12345	12345	19 (s) 0.33(m)	complete	03-03-2010 17:04:00
Securus Demo Site	LP 7	Uma User		12347	12347	25 (s) 0.42(m)	complete	03-25-2010 10:35:11
Securus Demo Site	LP 7	Ken Burns	kburns	POC1123 5555	3838383	20 (s) 0.33(m)	complete	03-25-2010 10:35:57
Securus Demo Site	LP 7	Ken Burns	kburns	POC1123 5555	3838383	91 (s) 1.52(m)	complete	03-25-2010 10:49:02

Sample Personal Allowed Number (PAN) Frequency Report

Personal Allowed Number (PAN) Frequency Report – allows investigators to research multiple occurrences of phone numbers among PAN lists. Users have the ability to enter threshold numbers to define search criteria. For example, a threshold of "four" will show phone numbers that appears in PAN lists more than four times.

Secure Call Platform

HOME SYSTEM MONITOR TOOLS ADMIN FACILITY PORTAL

MANAGEMENT LEVEL

Facility: Securus Demo Site Site: All Sites

PAN Frequency Search

FILL IN SEARCH CRITERIA (* Indicates Required Fields)

Threshold: []

Search EXCEL PDF CSV Reset

70 Results PAGE 1 OF 7

SITE	DIAL #	FREQUENCY
Securus Demo Site	(1) 9222278556	16
Securus Demo Site	(1) 9222278556	14

PAN Frequency Detail Search

FILL IN SEARCH CRITERIA (* Indicates Required Fields)

Country Code: 1 Dial Number: 922278556

Search EXCEL PDF CSV Reset

16 Results PAGE 1 OF 2

SITE	DIAL #	NAME	PIN
Securus Demo Site	(1) 9222278556	Pinax09 Pinax09 Pinax09	99110009
Securus Demo Site	(1) 9222278556	TL8802 TRH8602 TRH802	11100002
Securus Demo Site	(1) 9222278556	Test QA	992009
Securus Demo Site	(1) 9222278556	Test G ersit	0343 0343

Investigators enter a number into the threshold criteria field to research how many times phone numbers appear among the PAN lists of their facility and site(s).

By selecting the magnifying glass next to the displayed frequency number, users can run a detail report. This report displays information about each inmate having the number on their PAN list.

Sample PAN Management Report

PAN Management Report - interactive report providing a dashboard view of all PAN entries in the system. If a PAN entry is entered through the Inmate Managed PAN System, it is indicated on this report. Users can select from over twenty criteria to produce reports with multiple data points. All reports are exportable to Excel, CSV, and PDF.

Secure Call Platform Facility Routing Number: 99001

HOME SYSTEM MONITOR TOOLS ADMIN FACILITY PORTAL

MANAGEMENT LEVEL: Facility: Secure Demo Site

PAN Management Report

FILL IN SEARCH CRITERIA (Use * for wild card / partial searches)

Account #: [] PIN #: [] Checked: [] Reason: All []

Private: []

Stack: []

Record Calls: []

Passive Acceptance: []

Allow on Suspend: []

3-Way Call Detect: []

Search EXCEL PDF CSV Reset

994 Results PAGE 1 OF 10

NAME	ACCOUNT # / FBI	DELETED	STATUS	BLOCKED	RELATION	COB	SPEED DIAL	RELATIONSHIP	DESCRIPTION	NUM PROPERTIES	LAST MODIFIED
Christopher Adams	789456789456	(1) 9722770303	Y	✓					attorney		10-Nov-2010
Christopher Adams	789456789456	(1) 9722770303	Y	✓					Mother		10-Nov-2010
Reggie Adams	346282	(1) 9722770300	Y	✓					PAN for Admin security template		10-Nov-2010
QAL Albanita	9722770263 0363	(1) 9722992192	Y	✓					test des		10-Nov-2010
QAL Albanita	9722770363 0363	(1) 4682219918	Y	✓					test		10-Nov-2010

8/5/2013

Proprietary and Confidential

13

Sample SCP Debit Report

SCP Debit Report - is a valuable administrative report allowing users to:

- Query Inmate Debit/Prepaid call detail records (CDRs) by the user-specified criteria.
- View all debits and credits that occurred during a specific time period for an individual inmate - for all inmates within a facility or for all facilities.

Secure Call Platform

HOME SYSTEM MONITOR TOOLS ADMIN FACILITY PORTAL

MANAGEMENT LEVEL: Facility: Secure Demo Site

SCP Debit Report Search

(Negative numbers will be displayed in parenthesis)

FILL IN SEARCH CRITERIA (* indicates Required Fields)

(Use * for wild card / partial searches)

Inmate First Name: [] Last Name: [] Centry Account #: [] PIN: []

User Name: [] User Comments: [] Description: []

Type: ALL [] Amount: ALL [] Exclude Automated Process: []

Note: Please limit search range to no more than 21 days

Start: 10/19/2010 00:00:00 End: 11/18/2010 23:59:59

Search Reset

14 of 27

Site	Account # / FBI	Inmate First/Last	Type	Amount	Date/Time (In Central Time)	User	Reference #	Description	Comment
Secure Demo Site	0340 0343	Debit Test	Credit	\$100.00	11/18/2010 05:20:20	Geon@CCF3X.TX	201021050204-0343	Site Issued Credit	
Secure Demo Site	1032010 1032010-0318	TW LOCALS	Credit	\$100.01	10/28/2010 11:12:22	Ray@CCF3X.TX	20100228111224-1032010	Site Issued Credit	
				TOTALS					
				Action Type	Quantity	Amount			
				Payment	0	\$0.00			
				Credit	2	\$200.01			
				Debit	0	\$0.00			
					2	\$200.01			

8/5/2013

Proprietary and Confidential

14

Sample Voice Biometrics Status Report

Voice Biometrics Status Report— Allows users to see the status and configuration settings for each site, custody account, phone number, phone group, and phone. This report also shows changes to an inmate's account to assist administrators and investigators track user accountability.

Secure Call Platform Facility Routing Number: 99001

HOME SYSTEM MONITOR TOOLS ADMIN FACILITY PORTAL

MANAGEMENT LEVEL
 Facility: Securus Demo Site Site: All Sites Phone Group: All Phone Groups Phone: All Phones

Voice Biometrics Configuration Status Search

FILL IN SEARCH CRITERIA (* Indicates Required Fields)
 (Use * for wild card / partial searches)

Configuration Level: * Status: * Enrollment: *
 Sites: All Sites Enrolled: Enrolled
 Custody Accounts: Enabled: Enabled Not Enrolled: Not Enrolled
 Phone Numbers: Disabled: Disabled
 Phones: Phones

Search Reset

116 Results PAGE 1 OF 12 >>> [EXCEL](#) [PDF](#) [CSV](#)

INMATE NAME	CUSTODY ACCOUNT	ENROLLED	DEFAULT	ENABLED	DISABLED	SITE	ENROLLMENT LAST UPDATE BY	ENROLLMENT LAST UPDATE DATE
itest_test	00099887768		<input checked="" type="checkbox"/>			Securus Demo Site		
0363test_QA	41920111			<input checked="" type="checkbox"/>		Securus Demo Site		
Adam Edwards	998899					Securus Demo Site		11-10-2010
Atlanta Rec	42120111		<input checked="" type="checkbox"/>			Kelway Test Lab Allen		
Barry davis	7777	<input checked="" type="checkbox"/>				Securus Demo Site		12-15-2010
Barry davis	7777	<input checked="" type="checkbox"/>				Securus Demo Site		09-09-2009
Sjoe Pjackson	77994466		<input checked="" type="checkbox"/>			Securus Demo Site		
Broda McAlister	4809		<input checked="" type="checkbox"/>			Securus Demo Site		
Bryan Carrell	041367		<input checked="" type="checkbox"/>			Kelway Test Lab Allen		
CARLOS LOPEZ	688616		<input checked="" type="checkbox"/>			Kelway Test Lab Allen		

8/5/2013

Proprietary and Confidential

15

Sample Voice Biometrics Frequency of Failure Report

Voice Biometrics Frequency of Failure Report – an administrative and investigative report that allows users to see which inmates have failed Voice Biometrics verification attempts. Users may also see what percentage of inmates are passing or failing. Search criteria includes key information such as custody account, first and last name, and date range.

Secure Call Platform Facility Routing Number: 99001

HOME SYSTEM MONITOR TOOLS ADMIN FACILITY PORTAL

MANAGEMENT LEVEL
 Facility: Securus Demo Site Site: All Sites

Voice Biometrics Frequency of Failure Search

*This report is updated and populated nightly for faster retrieval purposes.
 *This is a report for inmate name verification attempts to show the Frequency of Failure when an inmate attempts to verify their name when placing a phone call.

FILL IN SEARCH CRITERIA (* Indicates Required Fields)
 (Use * for wild card / partial searches)

Custody Account #: First Name: Last Name:
 Start: 01/25/2010 End: 04/28/2011
 Search Reset

26 Results PAGE 1 OF 3 >>> [EXCEL](#) [PDF](#) [CSV](#)

INMATE NAME	CUSTODY ACCOUNT	LAST FAILED VERIFICATION	LAST SUCCESSFUL VERIFICATION	% OF FAILED VERIFICATION	% OF SUCCESSFUL VERIFICATION
BRIAN AARSTAD	104994	13-Oct-2010	13-Oct-2010	33.33	66.67
TestDialup Acct5	95555	02-Apr-2010		100.0	
QA1 Atlanta	9722770363	10-Mar-2010		100.0	
First01 BLau01	110001	27-Apr-2010	09-Apr-2010	67.57	32.43
Kenneth Burns	QA436	21-Apr-2011	21-Apr-2011	26.67	73.33
Ken Burns	0379	12-Apr-2011	08-Dec-2010	93.98	6.02
Adam Edwards	999999999999	02-Jun-2010	02-Jun-2010	33.33	66.67
Helen Huynh	89989	10-Mar-2010	10-Mar-2010	94.87	5.13
Helen Huynh	7890	16-Feb-2011	16-Feb-2011	84.13	15.87
James LeBoeuf	28770043	24-Jan-2011	23-Jan-2011	79.31	20.69

8/5/2013

Proprietary and Confidential

16

Sample Crime Tip Report

Crime Tip - is a critical feature that enables anonymous two-way communication between inmates and facility staff. For inmates the feature provides a secure method for reporting information about criminal activity. For facilities, the feature provides a flexible, configurable solution for gathering critical evidence to support investigations and prevent crimes from taking place in the facility. **The Crime Tip Report** - displays detailed results for all Crime Tip calls. Results can be narrowed by using intuitive search criteria. Users can select to listen to, extend, download, add notes to, or audit each call record to manage the safety and security of their facility.

Secure Call Platform Facility Routing Number: 99001

HOME SYSTEM MONITOR TOOLS ADMIN FACILITY PORTAL

MANAGEMENT LEVEL

Facility: Securus Demo Site All Sites

TIPS Search

FILL IN SEARCH CRITERIA (* Indicates Required Fields)

(Click * for auto call - partial searches)

Mail Box ID: Call Type: -- ALL --

Date Criteria: Date/Time Range Results Per Page: 10

Start Date/Time: 01/28/2011 00:00:00 End Date/Time: 04/28/2011 23:59:59

Search Reset

35 Results

SEARCH	SITE	PORT LOC	INFLY BUILDING ID	CALL TYPE	START	END	OUT 15
	Securus Demo Site	je test 4		Offender	04-19-2011 16:46:36	04-19-2011 16:47:01	0
	Securus Demo Site	je test 4		Offender	04-19-2011 16:49:39	04-19-2011 16:50:33	34
	Securus Demo Site	je test 4		Offender	04-21-2011 01:45:50	04-21-2011 01:46:42	32
	Securus Demo Site	je test 4		Offender	04-21-2011 01:51:03	04-21-2011 01:52:00	37
	Securus Demo Site	je test 4		Offender	04-21-2011 01:53:34	04-21-2011 01:54:03	29

8/5/2013 Proprietary and Confidential 17

Sample Informant Line Report

SCP's Informant Line - is an investigative tool allows inmates to communicate directly and anonymously with investigators. The call can be routed to a specific investigator, voicemail box, or answering machine. **The Informant Line Report** - allows investigators to research and view details about these calls.

Secure Call Platform Facility Routing Number: 99001

HOME SYSTEM MONITOR TOOLS ADMIN FACILITY PORTAL

MANAGEMENT LEVEL

Phone Group: Securus Demo Site All Sites

Phone: All Phone Groups

Informant Line Call Records Search

FILL IN SEARCH CRITERIA (* Indicates Required Fields)

(Click * for auto call - partial searches)

Country Code: Dialed Number: Destination Zone: -- ALL -- International:

Custody Account #: File #: Prepaid Account #: Watched:

First Name: Last Name: Private:

Termination Category: -- ALL -- Call Status: Complete Voice Biometrics:

Date Criteria: Date/Time Range Results Per Page: 100

Start Date/Time: 04/21/2011 00:00:00 End Date/Time: 04/28/2011 23:59:59 RCF:

Search Reset

2 Results

SEARCH	PORT LOC	DESTIN Z	START	END	ACT # PIN	PREPAID ACC#	NAME	CALL STATUS	WHM/EXT	CALL PROPERTIES
	Securus Demo Site	LP 17	(1) UNLISTED local	04-21-2011 02:04:40	04-21-2011 02:04:59	19 (1)		complete		Called party hangup
	Securus Demo Site	LP 17	(1) 9722770529 local	04-21-2011 02:17:50	04-21-2011 02:18:02	12 (1)	05343	complete		Called party hangup

8/5/2013 Proprietary and Confidential 18

Sample Emergency Call Report

SCP's Emergency call- is an optional SCP feature allowing individuals to enter a bypass code to connect to facility personnel for emergencies such as a medical, violent, riotous, or suspicious incidents. For users who are authorized to view and listen to historical Emergency Calls, SCP provides an Emergency Call Report as shown in the image below.

Emergency Call search criteria.

Emergency Call details and available actions.

SITE	PORT LOC	BYPASS CODE	DIALED #	EXT #	ACCT #	PIN	START	END	DURE	CALL STATUS	TERM CAT	CALL TYPE	EXTS	PDF	CSV
Securus Demo Site LP 17	311		(1) 9722770561	0343		0343	01-11-2012 04:51:18	01-11-2012 04:51:30	12 (s)	complete	Called party hangup	Emergency Call			
Securus Demo Site LP 17	311		(1) 9722770561	0000343		0000343	01-11-2012 04:52:05	01-11-2012 04:52:17	0.1 (m)	complete	Called party hangup	Emergency Call			

Sample Word Spotting Search Report

Word Spotting Search Report – is an essential investigative report that allows investigators to display all of the recordings that were submitted for Word Spotting processing with select criteria. Because Word Spotting is fully integrated with SCP, this report can be run right from the SCP user interface.

Enter criteria to narrow the search. Users can even search by the suspected key word flagged within the call.

View details of the report (including flagged word and the point in the call the word was flagged), listen to the call, download the call, or export the call.

SITE	PORT LOC	CITY CODE	DIALED #	REL NUMBER	ACCT #	PIN #	NAME	USER NAME	FLAGGED WORDS	FLAGGED WORDS START	FLAGGED WORDS END	EXTS	PDF	CSV
Securus Demo Site	LP 1	1	9722770490	04-26-2011 15:22:29	7890		Rexes	WordSpot	Busted	00:00:50.27	00:00:50.59			
Securus Demo Site	LP 1	1	9722770490	04-26-2011 15:22:29	7890		Rexes	WordSpot	Hit	00:00:25.48	00:00:25.41			
Securus Demo Site	LP 1	1	9722770490	04-26-2011 15:22:29	7890		Rexes	WordSpot	Shot	00:00:19.28	00:00:19.27			

Sample Comprehensive System Log Search

Comprehensive System Log Search – can be used by administrators to monitor the changes that have been made to the system. Administrators can use search criteria such as username, name, and date range to narrow their search. The tool also has the ability to omit changes made to the system through automated changes to narrow results to changes made by personnel.

Secure Call Platform
Facility Routing Number: 99001

HOME SYSTEM MONITOR TOOLS ADMIN FACILITY PORTAL

MANAGEMENT LEVEL

Facility	Site	Phone Group	Phone
Securus Demo Site	All Sites	All Phone Groups	All Phones

Comprehensive System Log Search

FILL IN SEARCH CRITERIA (* Indicates Required Fields)

(Use * for wild card / partial searches)

Username: <input type="text"/>	First Name: <input type="text"/>	Last Name: <input type="text"/>
Start: 04/25/2011 00:00:00	End: 04/28/2011 23:59:59	<input type="checkbox"/> Exclude Automated Process

4 Results PAGE 1 OF 1

RECORD TYPE	RECORD DETAIL	MODIFIED FIELD	BEFORE	AFTER	ACCESS/MOD TIME(EST)	USERNAME
System Access					04/28/2011 13:05:01	zabbix@SECUR.TX
Custody Account	99887766	Status	ACTIVE	INACTIVE	04/28/2011 11:03:23	smanne@SECUR.TX
Security Template	ADC-test1				04/28/2011 10:57:25	amercoe@SECUR.TX
DTN	8016138647	Watched	NONE	YES	04/27/2011 18:42:14	grieholson@SECUR.TX

Terms and Conditions
 © 2011 Securus Technologies, Inc. All Rights Reserved.

8/5/2013

Proprietary and Confidential

21

Sample Management Level Change Log Report

Management Level Change Log Report – can be used by administrators to monitor the changes made to features at each of the management levels. Administrators can use search criteria such as username, name, and date range to narrow their search.

Secure Call Platform
Facility Routing Number: 99001

HOME SYSTEM MONITOR TOOLS ADMIN FACILITY PORTAL

MANAGEMENT LEVEL

Facility	Site	Phone Group	Phone
Securus Demo Site	All Sites	All Phone Groups	All Phones

Management Level Change Log Search

FILL IN SEARCH CRITERIA (* Indicates Required Fields)

(Use * for wild card / partial searches)

Username: <input type="text"/>	First Name: <input type="text"/>	Last Name: <input type="text"/>
Start: 04/20/2011 00:00:00	End: 04/28/2011 23:59:59	

17 Results PAGE 1 OF 2

MANAGEMENT LEVEL	NAME	MODIFIED FIELD	BEFORE	AFTER	MODIFIED (EST)	USERNAME
Customer:	All Sites	Calling Restrictions		One Call per Wk Modified	04/21/2011 17:57:30	brodam@SECUR.TX
Site	Securus Demo Site	Calling Restrictions	One Call per Wk	NONE	04/21/2011 17:44:33	brodam@SECUR.TX
Site	Securus Demo Site	Calling Restrictions	NONE	One Call per Wk	04/21/2011 17:42:41	brodam@SECUR.TX
Site	Securus Demo Site	Calling Restrictions	One Call per Wk	NONE	04/21/2011 17:40:48	brodam@SECUR.TX
Customer:	All Sites	Calling Restrictions		One Call per Wk Modified	04/21/2011 17:27:10	brodam@SECUR.TX
Customer:	All Sites	Calling Restrictions		One Call per Wk Modified	04/21/2011 17:24:25	brodam@SECUR.TX
Customer:	All Sites	Calling Restrictions		One Call per Wk Modified	04/21/2011 17:20:59	brodam@SECUR.TX
Site	Securus Demo Site	Calling Restrictions	One a Day	One Call per Wk	04/21/2011 17:18:37	brodam@SECUR.TX
Customer:	All Sites	Calling Restrictions		New One Call per Wk Created	04/21/2011 17:17:41	brodam@SECUR.TX
Site	Securus Demo Site	Maximum Call Duration	60	5	04/21/2011 12:43:59	jnewman@SECUR.TX

8/5/2013

Proprietary and Confidential

22

Sample Custody Account Change Log Report

Custody Account Change Log Report – can be used by administrators to monitor the electronic and manual changes to custody accounts. Administrators can use search criteria such as PIN, username, name, and date range to narrow their search.

Secure Call Platform
Facility Routing Number: 99001

HOME SYSTEM MONITOR TOOLS ADMIN FACILITY PORTAL

MANAGEMENT LEVEL

Facility	Site	Phone Group	Phone
Securus Demo Site	All Sites	All Phone Groups	All Phones

Custody Account Change Log Search

FILL IN SEARCH CRITERIA (* Indicates Required Fields)

(Use * for wild card / partial searches)

Username: <input type="text"/>	First Name: <input type="text"/>	Last Name: <input type="text"/>
Custody Account Number: <input type="text"/>	Inmate First Name: <input type="text"/>	Inmate Last Name: <input type="text"/>
Start: 04/25/2011 00:00:00	End: 04/28/2011 23:59:59	Exclude Automated Process: <input checked="" type="checkbox"/>

3 Results PAGE 1 OF 1

ACCT #	NAME	MODIFIED FIELD	BEFORE	AFTER	MODIFIED TIME (CST)	USERNAME
99887766	test securus	Status	ACTIVE	INACTIVE	04/28/2011 11:03:23	smanne@SECUR.TX
99887766	test securus	PIN	NONE	99887766 (Created)	04/28/2011 10:59:41	smanne@SECUR.TX
99887766	test securus	Account Number	NONE	99887766(Created)	04/28/2011 10:59:41	smanne@SECUR.TX

Terms and Conditions
 © 2011 Securus Technologies, Inc. All Rights Reserved.

Sample PAN Entry Change Log Report

PAN Entry Change Log Report – PAN Change Log functionality records all actions that SCP users make to the verified field in the SCP user interface. It also allows administrators to examine all PAN list changes; specifically, when changes occur, and by whom, helping administrators and investigators track user accountability.

Secure Call Platform
Facility Routing Number: 99001

HOME SYSTEM MONITOR TOOLS ADMIN FACILITY PORTAL

MANAGEMENT LEVEL

Facility	Site	Phone Group	Phone
Securus Demo Site	All Sites	All Phone Groups	All Phones

PAN Entry Change Log Search

FILL IN SEARCH CRITERIA (* Indicates Required Fields)

(Use * for wild card / partial searches)

Username: <input type="text"/>	First Name: <input type="text"/>	Last Name: <input type="text"/>
City Code: <input type="text"/>	Phone Number: <input type="text"/>	
Custody Account Number: <input type="text"/>	Inmate First Name: <input type="text"/>	Inmate Last Name: <input type="text"/>
Start: 04/21/2011 00:00:00	End: 04/28/2011 23:59:59	Exclude Automated Process: <input checked="" type="checkbox"/>

28 Results PAGE 1 OF 3

ENABLED #	ACCT #	NAME	MODIFIED FIELD	BEFORE	AFTER	MODIFIED TIME (CST)	USERNAME
(1)	9724163062	4809 Brods Hoalister	Dialed Number	NONE	9724163062 (Created)	04/21/2011 17:30:16	brodam@SECUR.TX
(1)	9724163062	3348 Jill Newman	Dialed Number	NONE	9724163062 (Created)	04/21/2011 12:49:55	jnewman@SECUR.TX
(1)	9729801052	7777 Barry davis	Private	NO	NONE	04/21/2011 10:08:02	eseverson@SECUR.TX
(1)	9722770300	00099887768 test test	Dialed Number	NONE	9722770300 (Created)	04/21/2011 06:47:25	john1@SECUR.TX
(1)	9722770596	dee2508 dee qa	Status	Active	Inactive	04/21/2011 04:33:28	dscort@SECUR.TX
(1)	9722770596	dee2508 dee qa	Dialed Number	NONE	9722770596 (Created)	04/21/2011 04:33:14	dscort@SECUR.TX
(1)	9722770596	dee2508 dee qa	Status	Inactive	Deleted	04/21/2011 04:32:33	dscort@SECUR.TX
(1)	9722770596	dee2508 dee qa	Status	Active	Deleted	04/21/2011 04:31:48	dscort@SECUR.TX
(1)	9722770596	dee2508 dee qa	Status	Active	Inactive	04/21/2011 04:28:23	dscort@SECUR.TX
(1)	9722770596	dee2508 dee qa	Dialed Number	NONE	9722770596 (Created)	04/21/2011 04:27:58	dscort@SECUR.TX

Sample Phone Number Change Log Report

Phone Number Change Log Report – allows administrators to review all changes to controlled numbers on the Global list at both the agency and facility levels.

Secure Call Platform
Facility Routing Number: 99001

HOME SYSTEM MONITOR TOOLS ADMIN FACILITY PORTAL

MANAGEMENT LEVEL

Facility: Securus Demo Site | Site: All Sites | Phone Group: All Phone Groups | Phone: All Phones

Global List Change Log Search

FILL IN SEARCH CRITERIA (* Indicates Required Fields)

(Use * for wild card / partial searches)

Username: First Name: Last Name:
 City Code: Phone Number:
 Start: 04/25/2011 00:00:00 End: 04/28/2011 23:59:59 Exclude Automated Process:

38 Results PAGE 1 OF 4 >>

ENABLED #	MODIFIED FIELD	BEFORE	AFTER	MODIFIED TIME (CST)	USERNAME
(1) 8016138647	Watched	NONE	YES	04/27/2011 10:42:14	gnicholson@SECUR.TX
(1) 8016138647	Dialed Number	NONE	8016138647 (Created)	04/27/2011 10:42:14	gnicholson@SECUR.TX
(2) 8016138647	Speed Dial	NONE	1111	04/27/2011 10:42:14	gnicholson@SECUR.TX
(1) 9723771108	Dialing COG	NONE	Crime Tlo	04/28/2011 10:32:23	GIFC@SECUR.TX
(2) 9723771108	Dialed Number	NONE	9723771108 (Created)	04/28/2011 10:32:23	GIFC@SECUR.TX
(1) 9723771107	Description	NONE	informant line no dtmf for QA	04/28/2011 10:29:50	GSP1@SECUR.TX
(1) 9723771107	Un-list Account Information	NONE	NO	04/28/2011 09:52:29	GSP1@SECUR.TX
(2) 9723771107	Enable DTMF Passthru	NONE	NO	04/28/2011 09:52:29	GSP1@SECUR.TX
(1) 9723771107	Un-list Speed Dial Number	NONE	NO	04/28/2011 09:52:29	GSP1@SECUR.TX
(1) 9723771107	Un-list Port Location	NONE	NO	04/28/2011 09:52:29	GSP1@SECUR.TX

Sample User Management Change Log Report

User Management Change Log Report – allows administrators to review changes made to the account by selected users.

Secure Call Platform
Facility Routing Number: 99001

HOME SYSTEM MONITOR TOOLS ADMIN FACILITY PORTAL

MANAGEMENT LEVEL

Facility: Securus Demo Site

User Mgmt Change Log Search

FILL IN SEARCH CRITERIA (* Indicates Required Fields)

(Use * for wild card / partial searches)

MODIFIED Username: First Name: Last Name:
 MODIFIER Username: First Name: Last Name:
 Start: 04/28/2011 13:00:00 End: 04/28/2011 23:59:59

198 Results PAGE 1 OF 20 >>

SCP USERNAME	SCP NAME	MODIFIED FIELD	BEFORE	AFTER	MODIFIED TIME(CST)	USERNAME
lawrence@SECUR.TX	Tony	Lawrence	SITE	NONE	San Benito County Juvenile, CA	04/28/2011 13:59:04
lawrence@SECUR.TX	Tony	Lawrence	SITE	NONE	Prowers County Jail, CO	04/28/2011 13:59:04
lawrence@SECUR.TX	Tony	Lawrence	SITE	NONE	Pacific County Sheriffs Office, WA	04/28/2011 13:59:04
lawrence@SECUR.TX	Tony	Lawrence	SITE	NONE	Hilam County Jail, TX	04/28/2011 13:59:04
lawrence@SECUR.TX	Tony	Lawrence	SITE	NONE	Hason County Jail	04/28/2011 13:59:04
lawrence@SECUR.TX	Tony	Lawrence	SITE	NONE	Long Beach Ctrv Jail, CA	04/28/2011 13:59:04
lawrence@SECUR.TX	Tony	Lawrence	SITE	NONE	Gibson County Sheriffs Dept, TN	04/28/2011 13:59:04
lawrence@SECUR.TX	Tony	Lawrence	CUSTOMER	NONE	San Benito County, CA	04/28/2011 13:59:04
lawrence@SECUR.TX	Tony	Lawrence	CUSTOMER	NONE	Prowers County Jail, CO	04/28/2011 13:59:04
lawrence@SECUR.TX	Tony	Lawrence	CUSTOMER	NONE	Pacific County Sheriffs Office, WA	04/28/2011 13:59:04

Sample Security Template Change Log Report

Security Template Change Log Report – allows administrators to review modifications made to security template. Users can narrow their search by using criteria such as username, name, phone number, and date range.

Secure Call Platform
Facility Routing Number: 99001

HOME SYSTEM MONITOR TOOLS ADMIN FACILITY PORTAL

MANAGEMENT LEVEL
 Facility
 Securus Demo Site

Security Template Change Log Search

FILL IN SEARCH CRITERIA (* Indicates Required Fields)

(Use * for wild card / partial searches)

Username: First Name: Last Name:

Modify Template: Start: End:

Search Reset

5 Results PAGE 1 OF 1

SECURITY TEMPLATE	TYPE	MODIFIED FIELD	BEFORE	AFTER	MODIFIED (CST)	USERNAME
ADC-test1	Created				04/28/2011 10:57:25	amerce@SECUR.TX
Adam All	Modified	System - Custody Accounts First Calls are Free	NONE	CAN VIEW	04/26/2011 10:44:08	aedwards@SECUR.TX
Adam All	Modified	System - Custody Accounts First Calls are Free	NONE	CAN EDIT	04/26/2011 10:44:08	aedwards@SECUR.TX
Adam All	Modified	Security - Password Reset	NONE	CAN VIEW	04/26/2011 10:44:08	aedwards@SECUR.TX
Sally Z	Created				04/25/2011 20:45:14	szeikvogel@SECUR.TX

Terms and Conditions
© 2011 Securus Technologies, Inc. All Rights Reserved.

8/5/2013

Proprietary and Confidential

27

Sample System Access Log Report

System Access Log Report – allows administrators to manage user access by reporting lists of system users by date range. Users can narrow their search by using criteria such as username, name, and date range.

Secure Call Platform
Facility Routing Number: 99001

HOME SYSTEM MONITOR TOOLS ADMIN FACILITY PORTAL

MANAGEMENT LEVEL
 Facility
 Securus Demo Site

System Access Log Search

FILL IN SEARCH CRITERIA (* Indicates Required Fields)

(Use * for wild card / partial searches)

Username: First Name: Last Name:

Access Start: Access End:

Search Reset

5 Results PAGE 1 OF 1

USERNAME	NAME	TITLE	SECURITY TEMPLATE	IP ADDRESS	STATUS	LOG IN(CST)	LOG OUT(CST)	CLRNATCHNUM
cconklin@SECUR.TX	Cora	Conklin Supervisor	Adam All	209.163.225.158	Successful Login	04/28/2011 11:50:44	04/28/2011 12:21:43	31
cconklin@SECUR.TX	Cora	Conklin Supervisor	Adam All	209.163.225.158	Successful Login	04/28/2011 10:21:54	04/28/2011 10:52:41	31
cconklin@SECUR.TX	Cora	Conklin Supervisor	Adam All	209.163.225.158	Successful Login	04/28/2011 08:42:05	04/28/2011 09:12:39	31
cconklin@SECUR.TX	Cora	Conklin Supervisor	Adam All	209.163.225.158	Successful Login	04/27/2011 14:50:45	04/27/2011 20:37:13	346
cconklin@SECUR.TX	Cora	Conklin Supervisor	Adam All	209.163.225.158	Successful Login	04/27/2011 12:23:43	04/27/2011 12:54:27	31

Terms and Conditions
© 2011 Securus Technologies, Inc. All Rights Reserved.

8/5/2013

Proprietary and Confidential

28

Sample Recording Audit Log Report

Recording Audit Log Report – allows administrators to report and manage all activity for recording usage. Administrator can search on key criteria such as recording usage, name, call start/end, access start/end, dialed number and PIN.

Secure Call Platform
Facility Routing Number: 99001

HOME SYSTEM MONITOR TOOLS ADMIN FACILITY PORTAL

MANAGEMENT LEVEL

Facility	Site	Phone Group	Phone
Securus Demo Site	All Sites	All Phone Groups	All Phones

Recording Audit Log Search

FILL IN SEARCH CRITERIA (* Indicates Required Fields)

(Use * for wild card / partial searches)

Username:	First Name:	Last Name:	
Recording Usage: -- ALL --	Dialed Number:	Account #:	PIN #:
Call Start:	End:		
Expiration Start:	End:		
Access Start: 04/29/2011 12:05:00	End: 04/29/2011 23:59:59		

3 Results PAGE 1 OF 1

ACCESS TIME	RECORDING USAGE	NAME	ACCT #/ PIN	CALL START TIME	CALL END TIME	EXPIRATION DATE	USER	DIALED NUMBER
04-29-2011 12:35:48	PLAYBACK	James LaSseuf	28770043 2017	04-20-2011 04:52:29	04-20-2011 04:52:53	03/20/2011	RYenamads@SECUR.TX	2917595114
04-28-2011 12:06:48	PLAYBACK	padma alle	2011	04-20-2011 14:07:27	04-20-2011 14:07:30	03/20/2011	RYenamads@SECUR.TX	5617039957
04-28-2011 12:09:59	PLAYBACK	Helmi Hayeh	7890 7990	04-20-2011 13:01:56	04-20-2011 13:02:30	03/20/2011	RYenamads@SECUR.TX	8009726766

Requested Documentation

Sample Performance Reviews

- ✓ Securus
- ✓ Guarded Exchange



MISSOURI DEPARTMENT OF CORRECTIONS CONTRACT REVIEW APRIL 21 , 2016

Securus Technologies, Inc.
Proprietary & Confidential

Agenda

- Trends – Amy Hewitt
 - Trouble Tickets
 - Calls / Minutes / Average call time
 - Revenue
- Phone adds and projects
- GEX
- Round table - All



Trouble Ticket History

2011 Q4 Total	402
2012 YTD Total	903
2013 YTD Total	1337
2014 YTD Total	680
2015 YTD total	1098
Jan-16	84
Feb-16	96
Mar-16	106

Most common trouble tickets are:

- *Equipment issues / handsets*
- *Inmate complaint investigations*
- *SCP access requests*
- *User name and password resets*



Calls / Minutes / Average Call Times

Missouri Department of Corrections			
Total Calls/Minutes Per Month			
	Calls	Minutes	Average Call Time
2011	2,777,406	31,214,620	11.24
2012	13,503,304	149,492,028	11.07
2013	13,872,392	155,392,555	11.20
2014	14,726,481	158,758,688	10.78
Jan-15	1,278,660	13,890,725	10.86
Feb-15	1,268,221	13,919,396	10.98
Mar-15	1,392,715	15,004,385	10.77
Apr-15	1,320,953	13,862,844	10.49
May-15	1,325,330	13,732,059	10.36
Jun-15	1,283,382	13,134,149	10.23
Jul-15	1,311,312	13,325,580	10.16
Aug-15	1,318,691	13,460,049	10.21
Sep-15	1,270,642	13,030,979	10.26
Oct-15	1,329,481	13,695,092	10.30
Nov-15	1,367,185	14,127,160	10.33
Dec-15	1,440,994	14,838,186	10.30
2015	15,907,566	166,020,604	10.44
Jan-16	1,438,255	15,092,467	10.49
Feb-16	1,435,735	14,886,871	10.37
Mar-16	1,574,593	15,978,917	10.15



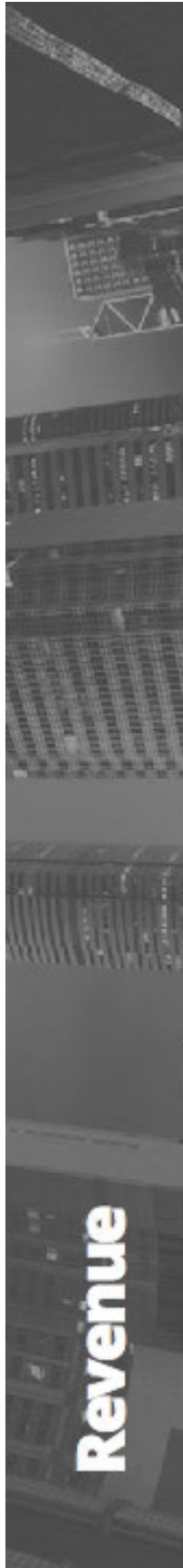

Month	Total Revenue Per Month Revenue
Mar-16	778,559
Feb-16	724,988
Jan-16	735,007
Dec-15	723,357
Nov-15	689,175
Oct-15	669,225
Sep-15	635,626
Aug-15	656,979
Jul-15	650,811
Jun-15	640,543
May-15	669,647
Apr-15	676,875
Mar-15	733,538
Feb-15	680,737
Jan-15	679,779
Dec-14	729,229
Nov-14	695,258
Oct-14	685,897
Sep-14	652,377
Aug-14	638,100
Jul-14	628,002
Jun-14	622,480
May-14	668,077
Apr-14	663,669
Mar-14	726,228
Feb-14	649,309
Jan-14	683,631

Phone adds / Projects

Discussion on current projects:

- VPN to VPN
- Circuit enhancements/replacements
- Training – Update

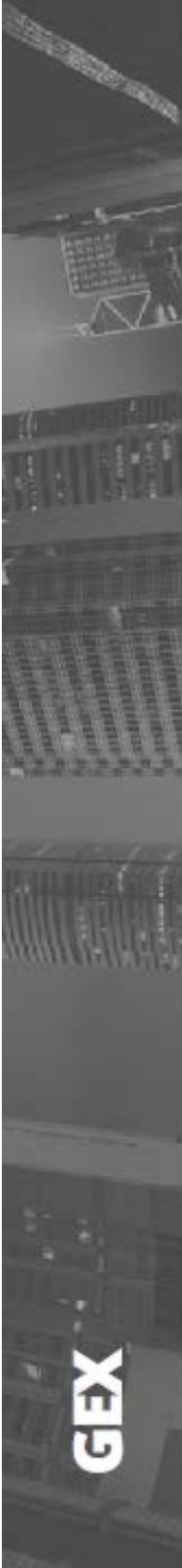

Guarded Exchange

SECURUS Technologies | 7

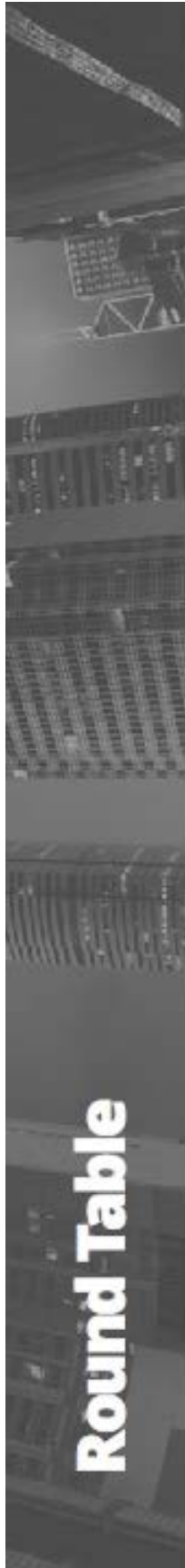

Round Table

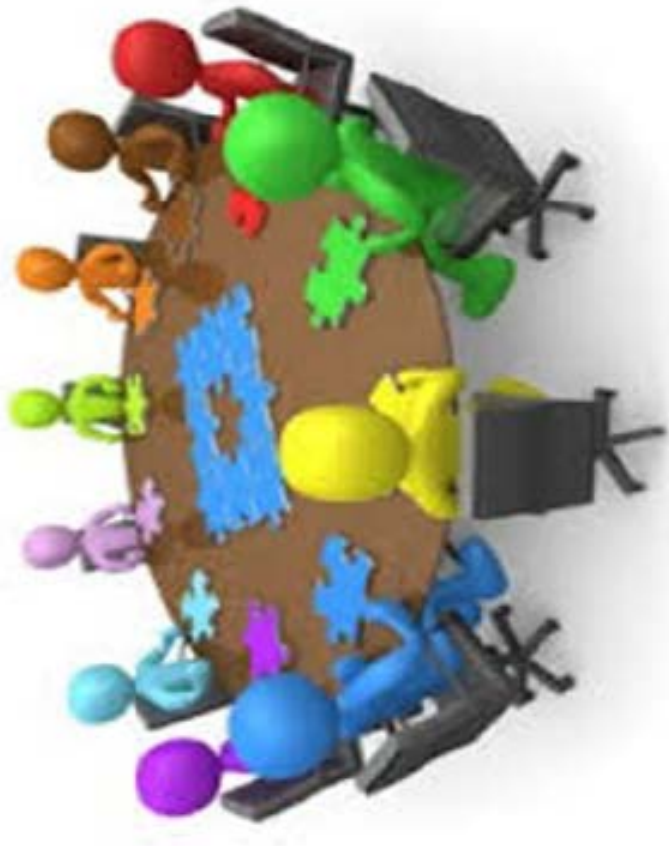

SECURUS Technologies | 8



SECURUS Technologies™

ABCD COUNTY ACCOUNT REVIEW

January, 2017

This document is proprietary and confidential. Intended addressee(s) review and/or use only.
No part of this document may be disclosed in any manner to a third party without the prior written consent of Securus Technologies Inc.

“

At Securus, our Mission is
to Serve and Connect, to
make our world Safe.

”

ACCOUNT REVIEW AGENDA

Service History

Product Performance and Utilization

Securus Communications

Customer Satisfaction

Training Opportunities

Feedback/Action Items



YOUR SECURUS TEAM

Your Securus team is dedicated to ensuring our corporate values are upheld by serving you with innovation, focus, integrity and honesty.



CINDY LAWSON

Sales Vice President
C.lawson@SecurusTechnologies.com
469-540-0006



LISA HORNE

Major Account Manager
L.Horne@SecurusTechnologies.com
972-277-0467



ASHLEY JONES

Client Manager
Ajones@SecurusTechnologies.com
214-775-4949



GRINNELL HAYWARD

Field Service Manager
G.hayward@SecurusTechnologies.com
678-548-7138



GLEN MCNEAL

Field Service Technician
G.Mcneal@SecurusTechnologies.com
404-594-0478

FACILITY SUPPORT

Securus Technical Support
866-558-2323
www.securustechnologies.com/contact-us

FAMILY & FRIENDS

Securus Correctional Billing Services
800-844-6591
www.securustech.net/contact-us

This document is proprietary and confidential, intended addressees only and/or use only. No part of this document may be disclosed in any manner to a third party without the prior written consent of Securus Technologies Inc.

SECURUS CORRECTIONAL BILLING SERVICES

Securus Correctional Billing Services:

Nationwide customer care and billing center dedicated to the inmates' family and friends open 24 hours per day, 365 days per year.

Call Center:

- 150 Agents located in Dallas, TX
- 3.4M calls handled per month
- 99.6% First Contact Resolution
- Online chat technology assists with 25,000 inquiries per month
- CSR's handle 150,000 calls per month
- 30,000 Family & Friends are surveyed per month with a 4.0 survey result score.
- Call types; payments, account set up, refunds, account service and fraud investigations

This document is proprietary and confidential, intended addressee(s) review and/or use only. No part of this document may be disclosed in any manner to a third party without the prior written consent of Securus Technologies Inc.

KEY ROLES & RESPONSIBILITIES

- Contact your Client Manager for all concerns.
- The Client Manager will engage the Major Account Manager accordingly.

Major Account Manager

New Product Introduction
Financial/Commission Questions
Contractual Questions Concerns & Renewals
Account Review & Strategic Account Planning
Customer Satisfaction/Value

Client Management

Day-to-Day Service & Support
Sales (pre/post) Opportunity Acknowledgement
Product Utilization Programs
Pro-Active & Re-Active Communications
Customer Satisfaction & Value Training Support
Account Review & Strategic Account Planning
Securus Release Communications

This document is proprietary and confidential, intended addressees only. No part of this document may be disclosed in any manner to a third party without the prior written consent of Securus Technologies Inc.



WHO'S RESPONSIBILITY IS IT?

Questions:	Answers:
Who should I contact if I have any problems?	Your Client Manager will engage the appropriate parties to resolve the problem.
Who is responsible for commission related items?	Your Major Account Manager is responsible for all commission related items.
Who is responsible for contract related items (includes renewals, adding products, etc.) ?	Your Major Account Manager is responsible for all contract related items.
Who is responsible for supporting my day-to-day needs?	Your Client Manager is responsible for supporting your day-to-day needs.
Who can I contact if I need Securus marketing materials for my lobby, visitation and/or other areas?	Your Client Manager will gladly order the Securus marketing materials for you.
Who can I contact if either myself or members of my staff (including groups) need product/feature training?	Your Client Manager will gladly coordinate training for you and/or your staff (new hire and/or refresher training).

No part of this document may be disclosed in any manner to a third party without the prior written consent of Securus Technologies Inc. This document is proprietary and confidential, intended addressees) review and/or use only.

ACCOUNT SERVICE HISTORY

SERVICE HISTORY: YEAR TO DATE, 2016

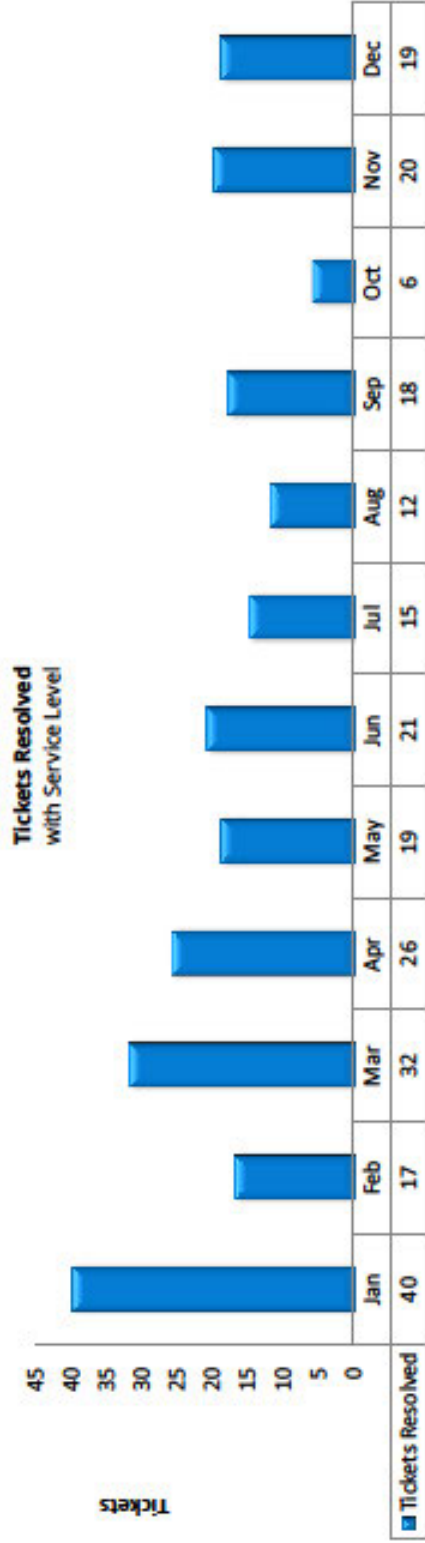

Tickets Resolved by Issue Type

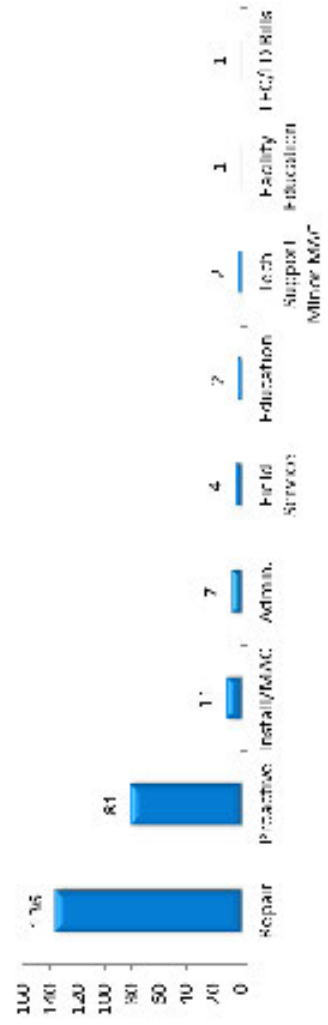

Priority	Tickets Resolved	Priority Status
1	2	30% or >
2	0	5% - 29%
3	125	5% or <
4	7	Development
Internal	111	System Alerts
Total	245	-

This document is proprietary and confidential, intended addressees review and/or use only. No part of this document may be disclosed in any manner to a third party without the prior written consent of Securus Technologies Inc.

SERVICE HISTORY – TICKET PRIORITY

Priority Classifications

"Priority 1"	60% or more of the functionality of the System is adversely affected by the System Event
"Priority 2"	30%-59% of the functionality of the System is adversely affected by the System Event
"Priority 3"	5%-29% of the functionality of the System is adversely affected by the System Event
"Priority 4"	Less than 5% of the functionality of the System is adversely affected by the System Event

Response Times

Priority 1	4 hours
Priority 2	12 hours
Priority 3	24 hours
Priority 4	36 hours

This document is proprietary and confidential, intended addressees only, review and/or use only.
No part of this document may be disclosed in any manner to a third party without the prior written consent of Securus Technologies Inc.

PRODUCT PERFORMANCE METRICS AND UTILIZATION

PRODUCT PERFORMANCE: YEAR TO DATE, 2016

*data excludes free calls

Product Utilization	Calls
Advance Connect	120,293
Instant Pay - PayNow	8,036
Instant Pay - Text2Connect	5,490
Direct Billed	1,919
Grand Total	135,738

Product Breakout

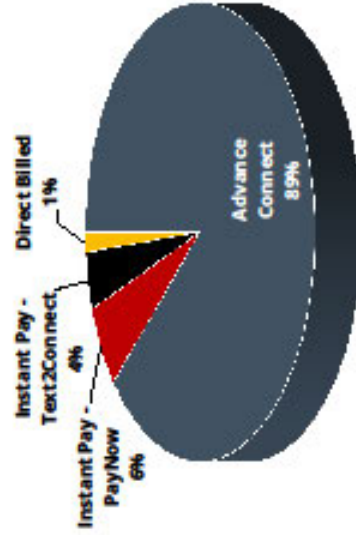

Products Currently Installed
Secure Call Platform (SCP)
Automated Information Services (AIS)
Location Base Services (LBS)
Securus Video Visitation (SW)
SW – Multi Session Live Monitoring
ConnectUS – Custom Apps
ConnectUS – SW App

Total Calls By Month

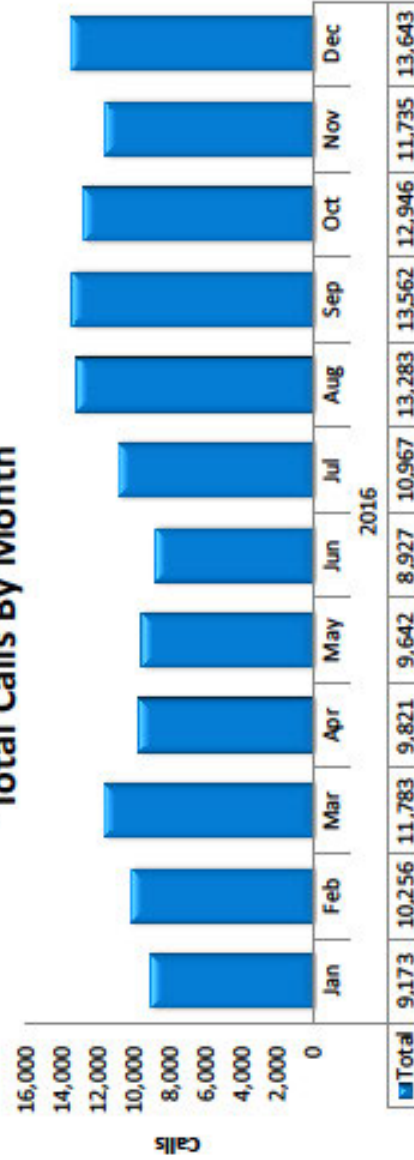

This document is proprietary and confidential, intended addressee(s) review and/or use only. No part of this document may be disclosed in any manner to a third party without the prior written consent of Securus Technologies Inc.

SECURUS VIDEO VISITATION : YEAR TO DATE, 2016

Securus Video Visitation,
Year To Date, 2016

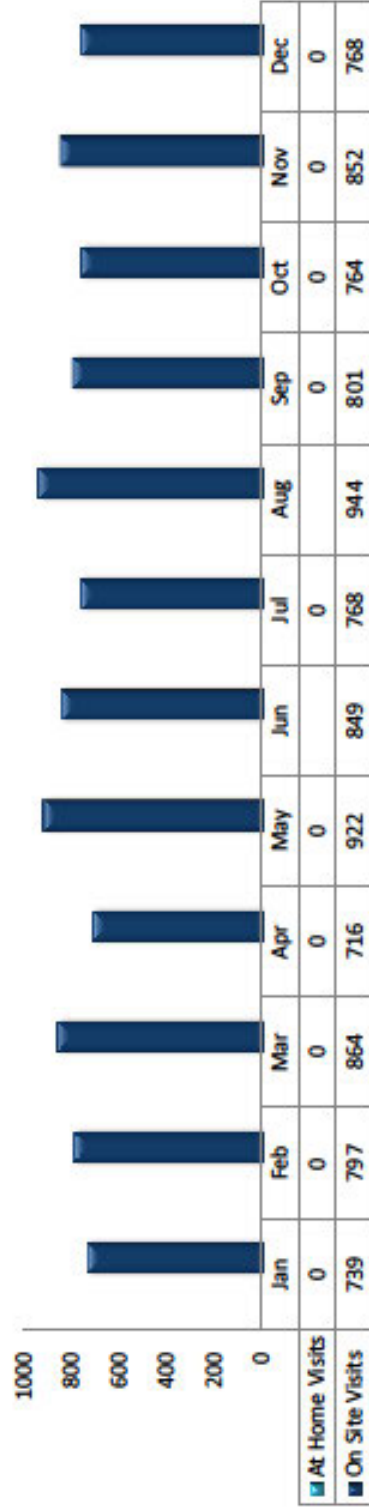

Month	At Home Visits	On Site Visits
Jan	0	739
Feb	0	797
Mar	0	864
Apr	0	716
May	0	922
Jun	0	849
Jul	0	768
Aug	0	944
Sep	0	801
Oct	0	764
Nov	0	852
Dec	0	768
Total	0	9784

This document is proprietary and confidential, intended addressee(s) review and/or use only. No part of this document may be disclosed in any manner to a third party without the prior written consent of Securus Technologies Inc.

SECURUS VIDEO VISITATION : YEAR TO DATE , 2016

SWV Volume By : Days & Visitation Hour

On-Site : SWV Volume By Days & Visitation Hours						
Hours	Mon	Tue	Wed	Thu	Fri	Grand Total
12:00 pm			2	2	1	5
1:00 pm			2			2
2:00 pm					1	1
3:00 pm					2	2
4:00 pm		1			2	3
5:00 pm	434	586	424	542	1	1987
6:00 pm	414	704	413	725		2256
7:00 pm	457	726	511	702		2396
8:00 pm	392	635	454	638		2119
9:00 pm	232	153	209	182		776
10:00 pm	35	61	70	70		236
11:00 pm					1	1
Grand Total	1964	2866	2085	2861	8	9784

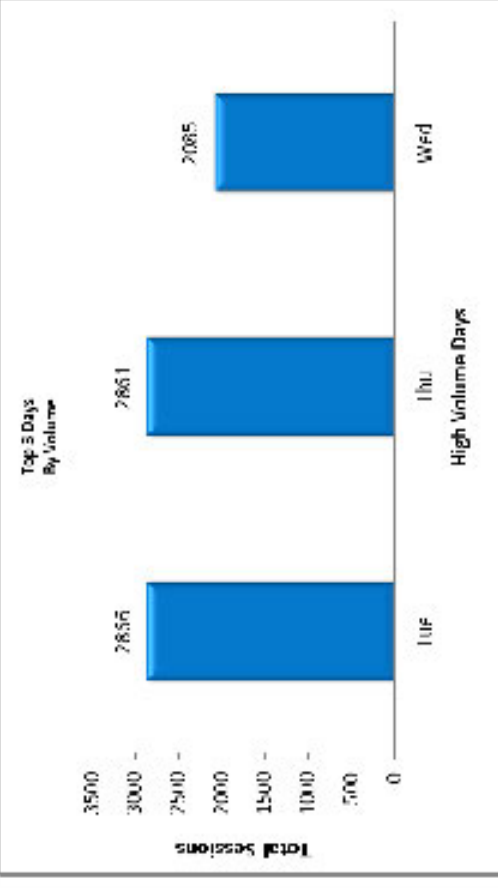
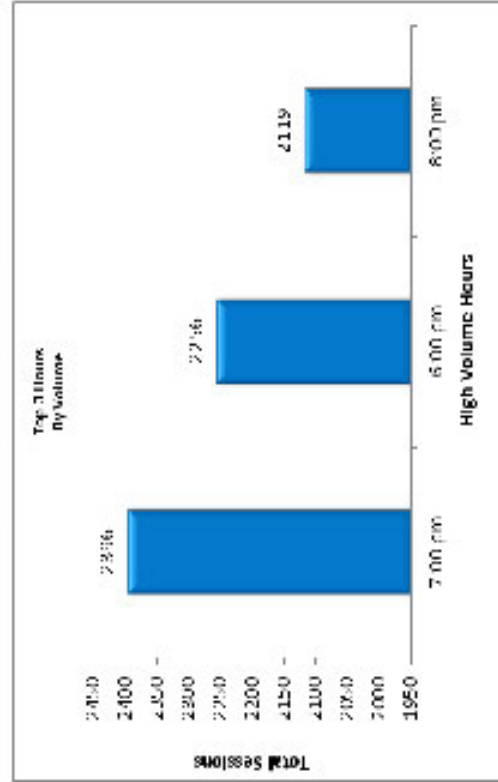
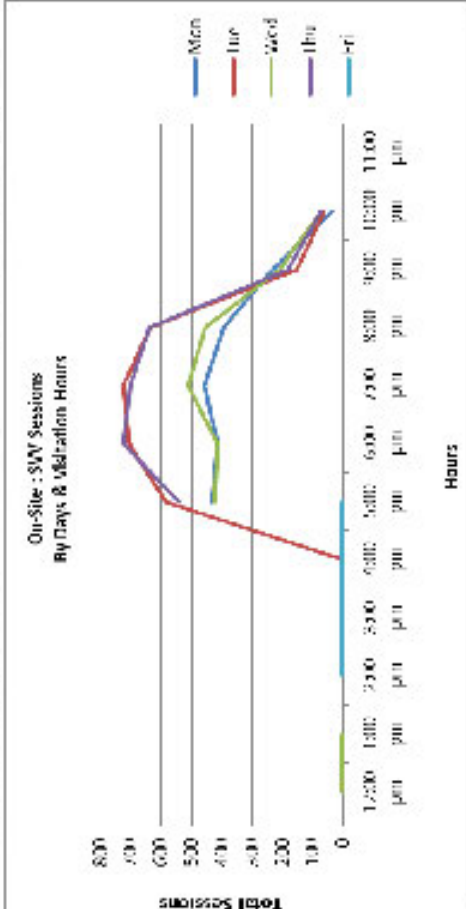

This document is proprietary and confidential, intended addressee(s) review and/or use only. No part of this document may be disclosed in any manner to a third party without the prior written consent of Securus Technologies Inc.

AI5 WEB REPORTING : YEAR TO DATE, 2016

Caller Usage Report

PUBLIC USAGE	
CALLS	
Total Calls	83,959
Forced Transfers	15,963
Administrative Transfers	22,655
Custom Transfers	1,180
Automation Rate	80.99%
Total Call Duration	1,482 hrs.47 mins.47 secs
Average Call Duration	1 min 3 secs
Phone Account Funding Selected	3,350
MENUS	
Main Menu Played	90,964
General Info Menu Played	4,619
Inmate Specific Menu Played	31,617
GENERAL INFO MENU OPTIONS	
Location Option	252
Visitation Option	631
Money Option	237
Mail Option	169
Medical Option	42
Property Option	162
Numbers Option	167
Custom fingerprint Option	56
Phones Option	164
INMATE LOOKUP	
Inmate Lookup Prompt Played	31,386
Inmate Name Confirmed	20,661
Inmate Birth Date Confirmed	12,893
INMATE SPECIFIC	
Info by Charge Played	17,547
Visitation Schedule Played	4,855
Inmate ID Played	1,880

INMATE USAGE	
CALLS	
Total Calls	3,088
Total Call Duration	43 hrs 35 mins
Average Call Duration	50 secs
MENUS	
Main Menu Played	3,742
LANGUAGE	
Info by Charge Played	2,602
Visitation Schedule Played	308

No part of this document may be disclosed in any manner to a third party without the prior written consent of Securus Technologies Inc. This document is proprietary and confidential, intended addressee(s) review and/or use only.

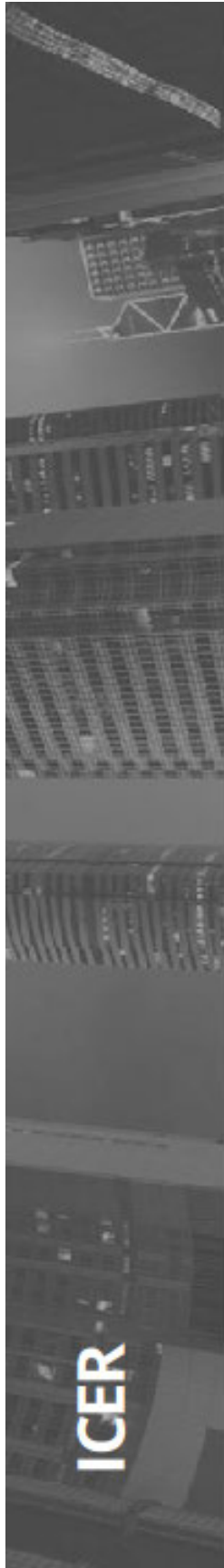

ICER™
 INMATE CELL COMMUNICATION
 EVALUATION AND REPORTING SYSTEM

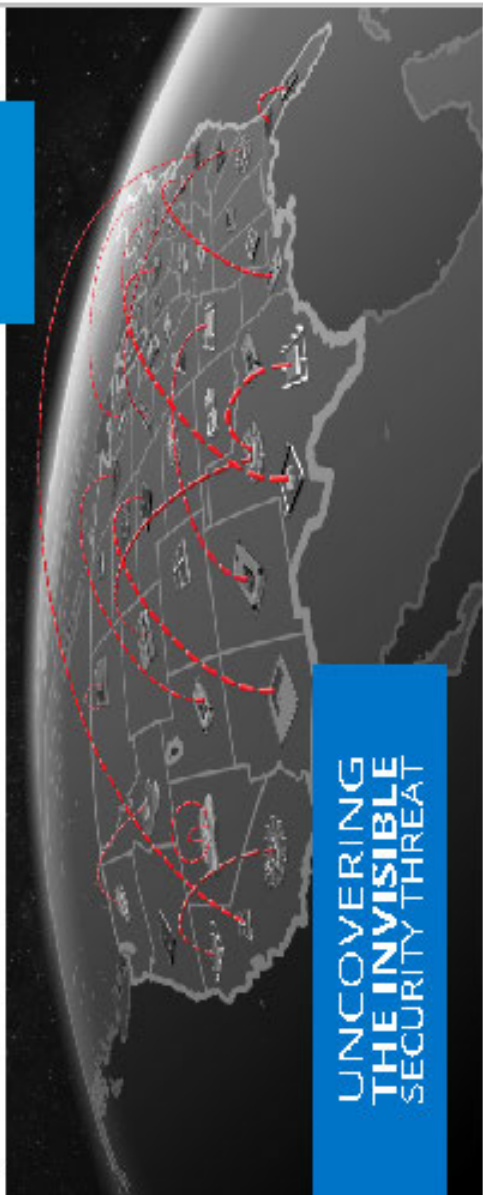

**UNCOVERING
 THE INVISIBLE
 SECURITY THREAT**

Fact: Inmates at your facility are using your inmate telephones to talk to other inmates.

Inmate-to-inmate communication has been a traditionally invisible security threat for correctional facilities for decades, since it was widely believed that inmates could not communicate with each other while in the facility. However, it is now possible to identify and track inmate-to-inmate communication that occurs between inmates in their cells, either so they don't know about them or simply don't believe in them — or if they were to access the frequency or severity of the problem.

Until now.

Available from CTL, ICS, TDMs, VoIP, or legacy ACER, the most effective system available today for detecting, monitoring, and controlling inmate-to-inmate communication, facility staff can control and stop inmate communication. Because of this, ACER has become the most frequently used system of its kind. Because of ACER, we now know that these events are real, they are happening both within the bars and between them, they occur nationwide, and with alarming frequency.

This document is proprietary and confidential, intended addressees (review and/or use only). No part of this document may be disclosed in any manner to a third party without the prior written consent of Securus Technologies Inc.

TRAINING OPPORTUNITIES

SCP - TRAINING OPPORTUNITIES

SCP INMATE TELEPHONE SYSTEM TRAINING

Secure-Call Platform



You are invited to attend our monthly training on Secure Call Platform (SCP). This course is suitable for investigators, new SCP users or as a refresher for current users. You can ask questions, talk with the instructor and request assistance on topics of interest to you. Join for all or part of the course. For additional questions, please contact Dean Ramsey at dean@securustechnologies.com or Lester Blency at lester@securustechnologies.com.

Covered Topics:

- SCP Overview and Navigation
- System Controls for phones, Phone Numbers and Inmates
- Monitoring Live Calls
- Reports: Finding Important Calls for Investigations
- Handling Important Calls to 411
- Administrative Functions (subject to time available - only if administrators are in attendance)

Training Details

Course Dates & Times:

2nd Mondays

3rd Thursdays

11:00 AM CST Every Month

8:00 AM CST Every Month except December

Course Length: 3 1/2 hours

INSTRUCTIONS

To join this class on any scheduled date and time, save these instructions on your calendar.

Please join the call 2-3 minutes early by clicking the link below. Log in as "GUEST" with your first and last names so we'll have a record of your attendance. No password is necessary. If possible, to avoid echo please use a telephone rather than the microphone and speakers on your computer.

The video conference has two parts: video and audio. Please follow these easy instructions:

1. VIDEO: Click this link to join the video conference. No password is required.
<https://atlantia-jointr-training.com/j1751194956077033600642>
2. AUDIO: Dial these numbers to join the audio conference. No password is required.
Conference Number: **510-365-3231**
Access Code: **498-258-061**

This document is proprietary and confidential, intended addressees) review and/or use only.
No part of this document may be disclosed in any manner to a third party without the prior written consent of Securus Technologies Inc.

CONNECTUS - TRAINING OPPORTUNITIES

SECURUS
Technologies

Connectus Introduction Training

You are invited to attend a web-training for **CONNECTUS** - the new Inmate Interface for their video terminals. This instruction is designed to provide an understanding of how the inmates will use the new interface. For more information, please contact instructor Dean Ramsey at deanr@securustechnologies.com.

Covered Topics:

- Introduction to the Main Menu
 - Content Resolution
 - Flexible Application Display
 - Multitasking, Digital Bulletin Board
 - Video Variation
- Videos - Inmate Introduction
 - Other Available Applications

INSTRUCTIONS

Dates: 2nd Thursday of each month

Time: 8:30 AM CENTRAL TIME - 1 hour

Please join the call a few minutes early. From the Video Conference, I will chat into the audio. You will need a computer with internet access and a speaker phone. It is possible to avoid echo please use a telephone rather than the microphone and speakers on your computer.

The video conference has two parts - audio and video.

1. **VIDEO:** Click [here](#) to join the audio conference. No password is required.

<https://attendee.gotomeeting.com/join/9197517185/79854591>

2. **AUDIO:** Dial these numbers to join the audio conference.

Conference Number: 510-665-1111

Access Code: 452 062 252

This document is proprietary and confidential, intended addressee(s) review and/or use only. No part of this document may be disclosed in any manner to a third party without the prior written consent of Securus Technologies Inc.

SECURUS Technologies | 20

SWW - TRAINING OPPORTUNITIES

SECURUS VIDEO VISITATION INTRODUCTORY TRAINING WEBINAR



You are invited to attend our monthly training for Securus Video Visitation (SVV). This course is suitable for new SVV users or as a refresher for current users. You can ask questions, talk to the instructor and request help on topics of interest to you. Join for one or both of the sessions. For more information, please contact instructor 12466@securus.com.

Covered Topics:

- Part 1 (morning session)
 - Menu navigation, Terminal Function, Connective Overview
 - Appointments - Scheduling, Consulting, Labs, Live Monitoring
- Part 2 (afternoon session)
 - Administrative Functions (subject to time availability)
 - User IDs, Rules, Reporting Rules, Reporting and Printing Reports
 - Viewing, Recorded Sessions, Downloading Texts and Turning to a CD

Training Details

Course Dates: 2nd Thursday of every month
Times: 9:00 AM CENTRAL TIME

INSTRUCTIONS

Please join each part of the conference a few minutes early. On the entry page, read the information and dial into the audio. You will need a computer with internet access and a speaker phone. If possible, to avoid audio please use a telephone and mute your computer microphone and speakers.

The video conference has two parts: video and audio. Please follow these easy instructions:

- 1. VIDEO:** Follow this link to join the video conference. Login as a "Guest" with your first and last name. No password is required.
<https://attendee.gotomeeting.com/join/715105144159906306>
Click will register you for both parts 1 and 2.
- 2. AUDIO:** Dial these numbers to join the audio conference. No password or PIN is required.
Conference Number: 510-365-3231
Access Code: 655-414-717

This document is proprietary and confidential, intended addressees only and/or use only. No part of this document may be disclosed in any manner to a third party without the prior written consent of Securus Technologies Inc.



LBS - TRAINING OPPORTUNITIES

LOCATION-BASED SERVICES TRAINING WEBINAR



You are invited to attend our training for Location Based Services (LBS). This course is suitable for new LBS users or as a refresher for current users. You can ask questions, talk to the instructor and request help on topics of interest to you. For more information, please contact instructor: Mark Lester at mlester@securus technologies.com.

TRAINING DETAILS:

Course Date: 2nd Wednesday Every Month
Time: 10:00 AM CST 11:00AM CST

INSTRUCTIONS:

Please join the call a few minutes early. On the entry page, find the call-in information and dial-in to the audio. You will need a computer with internet access and a speaker/phone.

This video conference has two parts – audio and video. Please follow these easy instructions.

1. **VIDEO:** Follow this link to join the video conference. No password is required.

<https://attendee.gototraining.com/rl/45318/8344126116097>

2. **AUDIO:** Dial these numbers to join the audio conference. The audio PIN will show after joining the training.

Conference Number: 510 365 3231
Access Code: 960 941 237

This document is proprietary and confidential, intended addressees) review and/or use only. No part of this document may be disclosed in any manner to a third party without the prior written consent of Securus Technologies Inc.

ICER - TRAINING OPPORTUNITIES

ICER MONTHLY WEBINAR TRAINING



You are invited to attend our monthly training on the ICER (Inmate Inter-Communications Evaluation and Reporting) platform. This course is suitable for investigators, new staff users or as a refresher for current users. You can ask questions, talk with the instructor and request emphasis on topics of interest to you.

For additional questions, please contact Lester Blisny at Lblisny@securustechnologies.com.

- Covered Topics:
 - Problem Solving Inmate-to-Inmate Communications
 - ICER Overview
 - How does ICER work
 - ICER Event Report
 - According to ICER
 - User, Role
 - User Administration

Webinar Details

Course Date & Time:

Every 3rd Wednesday, 10AM – 11AM CST

Course Length: 1 hour

To join this class on any scheduled date and time, save these instructions on your calendar.

Please join the call 2-3 minutes early by following the link below. Log in as "GUEST" with your first and last names. We will have a number of your attendees. No password is necessary. You will need a computer with Internet access and a speaker phone. If possible, to avoid echo please use a telephone for audio. Instead of your computer's microphone and speakers.

The video conference has two parts: video and audio. Please follow these easy instructions:

- VIDEO:** Click the link to join the video conference. No password is required.
<https://attendee.gotomeeting.com/j1/2463782647/12843522>
- AUDIO:** Dial these numbers to join the audio conference.
Conference Number: **510-365-3231**
Access Code: **291-963-264**

This document is proprietary and confidential, intended addressee(s) review and/or use only. No part of this document may be disclosed in any manner to a third party without the prior written consent of Securur Technologies Inc.

TRAINING OPPORTUNITIES

You are invited to attend Securus training on iCER (Inmate Inter Communications evaluation and reporting) platform. This course is suitable for investigators, new iCER users or as a refresher for current users. You can ask questions, talk with the instructor and request emphasis on topics of interest to you. For additional questions, please contact Lester Disney at Ldisney@securustechnologies.com.

Covered Topics:

- Problem with Inmate-to-Inmate Communications
- iCER Overview
- How does iCER work?
- iCER Event Report
- Accessing iCER
- Using iCER
- iCER Administration

Webinar Details

Course Date & Time: **Every Third Wednesday, 10AM – 11AM CST**

Course Length: 1 hour

INSTRUCTIONS

To join this class on any scheduled date and time, save these instructions on your calendar.

Please join the call 5-10 minutes early by clicking the link below. Log in as "GUEST" with your first and last names so we'll have a record of your attendance. No password is necessary. You will need a computer with Internet access and a speaker phone.

The video conference has two parts – audio and video. Please follow these easy instructions:

1. **VIDEO:** Click this link to join the video conference. Login as a "GUEST" with your first and last name. No password is required.
<http://securustech.adobeconnect.com/r4f/r18d13a/>
2. **AUDIO:** Dial these numbers to join the audio conference. No password or PIN is required.

Conference Number: **1-877-710-1114**

Conference ID: **0694#**

Test system on your computer:

https://securustech.adobeconnect.com/zoom/join/help/en/support/meeting_test.htm

This document is proprietary and confidential, intended addressees) review and/or use only.

No part of this document may be disclosed in any manner to a third party without the prior written consent of Securus Technologies Inc.

SECURUS Technologies | 24

SECURUS COMMUNICATIONS



December 1, 2016

Securus Successfully Defends United States Patent Before Federal Trial and Appeal Courts

United States Patent and Trademark Office Rules In Favor of Securus Technologies and Retains Significant Elements of Claim in the United States Patent

Securus Technologies, a leading provider of civil and criminal justice technology solutions for public safety, investigation, corrections and monitoring, announced today that it has received a significant win from the Patent Trial and Appeal Board (PTAB) related to a patent infringement filing by Clibet Talk (CTL). Despite CTL's arguments that its patent should be totally invalidated, the court ruled with Securus on many significant elements of the United States Patent.

Summary of Video Patent

U.S. Patent No. 8,322,255 – On-Demand Video Communication for Contacted and/or Identified Parties to a Business. The patent relates to on-demand video communications for contacted third parties, facility residents, and/or prisoners. Either party (resident or third-party) may offer/accept conversion of a voice call to video communication. “We were pleased to get the Patent Trial and Appeal Board’s decision in our favor,” said Richard Smith, Chief Executive Officer of Securus Technologies. “Ultimately, we enjoy significant advantages over CTL in issued patents, pending patents, in force patents, and our Patent Trial and Appeal Board decision. Our agreements with third party providers in our sector, including two (2) previous licensing deals with CTL, had with Securus over a ten (10) year period,” said Smith. “This court’s legal decision will be a tremendous win for our shareholders and advanced development efforts. The Patent Related Metrics that I referred to are provided below in this Press Release.”

Patent Related Metrics		Advantage		Ratio	
Securus	GTL	Securus	Securus	Securus	Securus
Issued Patents	158	51	1 Securus	3.1X	1.0X
Pending Patents	411	277	1 Securus	1.5X	1.0X
Issued Patents	276	77	1 Securus	3.6X	1.0X
Pending Patents	120	49	1 Securus	2.7X	1.0X
In-Force Patents	111	0-2	1 Securus	NA	NA
Patent Win/Loss Record					

Published filings, non-published filings are not available at this time.

CTL has filed twenty three (23) patent-infringement lawsuits against Securus and has only been successful in one (1) out of four (4) patents to date. My estimate is that they have spent over \$20 million in that effort – so not a very good return on that money for them,” said Smith. “At that rate, they will have to spend in excess of \$200 million attempting to invalidate all of our patents and that effort clearly will not be successful – but I encourage them to try. A more prudent approach would be to have a license agreement with Securus – from my perspective, that is the best business case for them with the highest NPV (Net Present Value). I expect that this PTA invalidation process will continue for a long time – 5 to 10 years, and I am prepared to stick with it and request a reasonable price.”

For additional information visit us at:
<http://www.securustechnologies.com/about-us/press-releases>

This document is proprietary and confidential, intended addressees review and/or use only. No part of this document may be disclosed in any manner to a third party without the prior written consent of Securus Technologies Inc.



SECURUS COMMUNICATIONS

December 1, 2015

**Securus Acquires PHD Medical's Corrections Telemedicine Assets in All Cash Transaction
Objective of Providing High Quality, Faster, and Lower Cost Health Care Services to \$5 Billion Corrections Market**

**Securus Announces 20th Acquisition of Government Services, High Tech, Software Based Businesses, Technologies, Partners
and Exclusive Partner Agreements**

Securus Technologies, a leading provider of civil and criminal justice technology solutions for public safety, investigation, corrections and monitoring, announced today that it has acquired PHD Medical's corrections focused telemedicine hardware, software, management, and development assets in Baie d'Urfe, Quebec, Canada (a suburb of Montreal).

Founded in 2005 near Quebec, Canada, PHD Medical, Inc. is the culmination of a team of medical professionals with extensive experience in respiratory medicine, regulatory affairs, software, manufacturing, and networked communications. This team developed a corrections focused telemedicine solution that improves the utilization, and value, of existing inpatient and out-patient products and services.

"We have worked with PHD Medical for several years and watched as they developed the hardware, software, and business model to the point of having a successful enterprise solution for the corrections market," said Richard A. Smith, Chairman and Chief Executive Officer of Securus Technologies. "We closed on the purchase of the telemedicine assets in all cash with PHD Medical, Inc. on November 30, 2015. Our objective is to refine our business model and to bundle the telemedicine products into our other existing corrections environment product set," said Smith.

"We have known Securus for a long time and they clearly have the broadest, high-tech product set for law enforcement and corrections – and that is exactly who we want to partner with," said Gregory T. Brouillette, Managing Director of PHD Medical. Mr. Brouillette will be joining the Securus Team as well as other PHD Medical staff members.

"Securus has an established infrastructure, the largest Sales Team in the sector, and our database the world's most well-suited for our purchase of the telemedicine assets," said Brouillette.

"With our purchase of the telemedicine assets, we are developing electronic medical records systems, our purchase of Archonix in 2013 that offers jail management systems including health care modules, and now the telemedicine business from PHD Medical, we are expanding our capabilities to serve the \$5 billion corrections health care market. Next to salaries, inmate health care costs represent the second largest component of prison and jail budgets – and with telemedicine our facilities can be more efficient, more cost-effective, and ultimately provide better and faster health care for our inmates – that's what we want to help them do," stated Smith.

"We will fully integrate the telemedicine and human resources assets the PHD Medical Team to further develop their platforms and sell that value in a combined bundle with other products. There is so much that we can do with our facilities to improve security, reduce operating costs, and improve the quality of health care. Let's use more technology to help them do their jobs," concluded Smith.

For additional information visit us at:
<http://www.securustechnologies.com/about-us/press-releases>

This document is proprietary and confidential, intended addressees only and/or use only.
No part of this document may be disclosed in any manner to a third party without the prior written consent of Securus Technologies Inc.

SECURUS COMMUNICATIONS

December 6, 2016

Securus Technologies Commits To Five (5) Year Funding For Prison Entrepreneurship Program (PEP)
Transforming Men, Their Families, and All of Our Communities Through Rehabilitation and Recovery Support
Exclusive Agreement to Fund PEP to Nelson and Jill Paulina Nationwide

Securus Technology and the Prison Entrepreneurship Program (PEP) jointly announced today a five (5) year funding commitment by Securus to PEP and an exclusive agreement to support the national and recovery support to more inmates and their families.

PEP History

Established in 2004, the Prison Entrepreneurship Program (PEP) is an independent 501(c)(3) nonprofit organization. PEP has pioneered the business program to meet the national entrepreneurship, entrepreneurship, and MBA students with consistent financial entrepreneurial support and mentor by program participants so as to prevent recidivism, maximize self-sufficiency and financial stability. PEP is dedicated to deliver the best business training, maximum field PEP provides unparalleled personal and professional development to those who are at risk of re-offending in society. They have the most solid support structure to pursue quality, fulfilling and productive lives. PEP clients are introduced to a variety of support services to include: executive volunteerism, executive volunteerism, business plan mentorship and seasoned professionals and a highly competitive business plan competition.

Rigorous Program Work – Superior Support Structure

PEP's mentorship program will be a classroom in itself. It has been described by many as a mini-MBA for the incarcerated business information is delivered and the program pace the most demanding. PEP is not an easy program, and it isn't for everyone. To be successful, students must be willing to learn, new skills, think hard, work hard and be open to transformation. PEP support is available for: [www.entrepreneur.com](#).

Transforming, Recombining and Building Hope

PEP is more than building business skills and an income. It is designed to bring positive, transformative changes to the students' lives and communities. This is exactly the type of program that we want to partner with because that program provides a critical link to all their lives. It is the only program that provides the support, training, and mentorship that Richard A. Smith, Chairman and Chief Executive Officer of Securus Technologies.

PEP is partnering with PEP to raise the form of a substantial financial commitment, training and using our sales team and executives to promote the program. In addition to Securus' executive volunteerism to support PEP's educational requirements, Securus is investing in people – PEP is the best way to reduce recidivism. It has been described as "the most solid link in the chain."

PEP is a multi-year program – it is a personal revolution in the way inmates in prison are educated and supported. It is in the facility and outside the facility. [www.entrepreneur.com](#) is the only program.

We provide a multi-year program that covers these areas:

- Leadership • Guest for Audiences • Marketing • Computer Skills • Development of Business Plans • Public Speaking
- Entrepreneurship and Life Coaching • Mentorship and Being Mentored

All PEP, executive leaders and managers to transform inmates and executives by unlocking human potential through entrepreneurial passion, education and the future. This is our business and we love what we do, and Securus is helping us extend our reach. [www.entrepreneur.com](#)

For additional information visit us at:

<http://www.securustechnologies.com/about-us/press-releases>

This document is proprietary and confidential, intended addressees review and/or use only.
No part of this document may be disclosed in any manner to a third party without the prior written consent of Securus Technologies Inc.

CUSTOMER SATISFACTION

CUSTOMER SATISFACTION: VALUE/RELATIONSHIP SURVEY

Contact Name Facility Name Facility State		CAPTAIN ABCD ABCD COUNTY GA				
Your Most Valued Partner		N/A = Not Applicable 1 = Strongly Disagree 2 = Disagree 3 = Neutral 4 = Agree 5 = Strongly Agree				
1. Securus has a thorough understanding of our needs.		N/A 1 2 3 4 5				
2. Securus' products and services make a difference with our needs.						
3. I feel that we're utilizing all of the products and services Securus has to offer.						
4. We have seen a measurable financial benefit from product and services delivered by Securus.						
5. By using Securus' products our operations and staff are more efficient and/or effective.						
6. We view Securus as a technology leader in our industry.						
7. We find that Securus is more of a technology and communications provider than just a phone provider.						
Sales		N/A 1 2 3 4 5				
8. We are satisfied with the amount of contact we have had with our Sales Representative.						
9. Our Sales Representative responds to our needs and gives us excellent sales support.						
10. Our Sales Representative has discussed with us how Securus solutions can fulfill our needs.						
11. Our Sales Representative is helpful and keeps in touch with us while we have any outstanding issues.						
Client Manager Team (ART)		N/A 1 2 3 4 5				
12. We are satisfied with the amount of contact we have had with our Client Manager Liaison.						
13. Our Client Manager Liaison responds to our needs and gives us excellent account relations support.						
14. Our Client Manager Liaison is helpful and keeps in touch with us while we have any outstanding issues.						
Technical Support Center (Concerning Securus' Equipment Technical Support, Toll-Free Number)		N/A 1 2 3 4 5				
15. When we call the Securus 800 technical support number, the people we talk to are polite and courteous in addressing our service request.						
16. I am satisfied with technical supports ability to understand our service needs and provide a resolution.						
17. I am satisfied with the ease in which I am able to communicate my service needs and the level of responsiveness provided by technical support.						
18. I am satisfied with my overall experience with the Technical Support Center in regards to my service request needs.						
Service Technician (Concerning your on-site Field Technician)		N/A 1 2 3 4 5				
19. Our Field Service Technician, keeps us informed and updated as to the status of our issues when dispatched.						
20. Our Field Service Technician demonstrates proficient technical understanding of our service needs.						
21. Our Field Service Technician is courteous, friendly and professional in attitude and appearance.						
22. Our Field Service Technician assists us with all issues when brought to his or her attention.						
Correctional Billing Services		N/A 1 2 3 4 5				
23. I am satisfied the friends and families of our inmates are provided friendly, courteous and knowledgeable service when they call the Securus Correctional Billing Service 800 support number.						
Overall Rating		No Answer Fails to Meet Expectations Meets Expectations Exceeds Expectations				
24. Our experience with SECURUS Technologies, Inc.		0 = Extremely Unlikely 1 2 3 4 5 = Neutral 6 7 8 9 10 = Extremely Likely				
Overall Rating		0 1 2 3 4 5 6 7 8 9 10				
25. How likely are you to recommend Securus Technologies to other facilities?						

No part of this document may be disclosed in any manner to a third party without the prior written consent of Securus Technologies Inc.

CUSTOMER SATISFACTION: TECH SUPPORT SURVEY

Facility Name	ABCD COUNTY					
	N/A = Not Applicable	1 = Strongly Disagree	2 = Disagree	3 = Neutral	4 = Agree	5 = Strongly Agree
Initial Technician (Concerning your initial contact with Technical Support)	N/A	1	2	3	4	5
1. Technical Support efficiently and effectively fielded our initial service request (FAX/CALL/EMAIL) and communicated next steps.						
2. The person who took our initial report was polite and courteous.						
Service Representative (Concerning the service representative that worked with you via telephone)	N/A	1	2	3	4	5
3. The Securus Service Representative was knowledgeable and helpful.						
4. The Securus Service Representative communicated resolution regarding our service request.						
Overall Service Experience	N/A	1	2	3	4	5
5. During this request, we received excellent service from Securus technical support.						

Any score 3 or below is considered an Improvement Opportunity

This document is proprietary and confidential, intended addressee(s) review and/or use only. No part of this document may be disclosed in any manner to a third party without the prior written consent of Securus Technologies Inc.

CUSTOMER SATISFACTION: DISPATCH SURVEY

Facility Name	ABCD COUNTY				
Facility Contact	CAPTAIN ABCD				
N/A = Not Applicable 1 = Strongly Disagree 2 = Disagree 3 = Neutral 4 = Agree 5 = Strongly Agree					
Initial Technician (Concerning your initial contact with Technical Support)					
1. Technical Support efficiently and effectively fielded our initial service request (FAX/CALL/EMAIL) and communicated next steps.					
Dispatcher (Concerning the person that scheduled the on-site visit)					
2. Dispatch clearly communicated information regarding the Field Service Technicians ETA.					
Service Technician (Concerning your on-site Field Technician)					
3. Once dispatched, we are satisfied with the response time of our Field Service Technician.					
4. Our Field Service Technician kept us informed throughout the visit and confirmed the resolution of our service request.					
5. Our Field Service Technician demonstrated technical understanding and knowledge of our service issue.					
Overall Service Experience					
5. Our service request was fully resolved to our satisfaction.					

Any score 3 or below is considered an Improvement Opportunity

No part of this document may be disclosed in any manner to a third party without the prior written consent of Securus Technologies Inc.

SECURUS Technologies | 33

FEEDBACK/ACTION ITEMS

FEEDBACK AND ACTION ITEMS

Action Items	Owner	Due Date

**Guarded
Exchange™**



2016 Quarterly Report

July-September

Table of Contents

Special Services.....	2
After Hours Program	2
Crime Tip Hotline.....	2
Inmate Inter-Communication Evaluation & Reporting.....	2
Canine Contraband Detection Services.....	3
Monitoring Highlights.....	6
Contract to Date Call Volume.....	6
Call Volume	6
Information Highlights.....	6
Report Origins	7
Reports by Origin.....	7
Requests for Investigative Assistance.....	7
Translation Requests.....	7
Saturation Requests.....	8
Financial Reports and Emails	9
Submitted Reports by Office.....	10
Information Distribution.....	10
Reports distributed to Social Services and various other agencies	10
Report Topic Breakdown.....	11
OIG Findings for GEX Reports.....	12
Forensics Highlights.....	13
MCA.....	14

Special Services

After Hours Program

During Q3 of 2016, there were no After Hours requests received.

Crime Tip Hotline

Guarded Exchange (GEX) began assisting the Inspector General's Office (OIG) with monitoring Prison Rape Elimination Act (PREA) and Crime Tips Hotline calls in November 2014. As part of the Crime Tips Hotline program, Guarded Exchange was tasked with monitoring hotline calls outside the hours of operation of the OIG Investigator's schedule. This ensures that all PREA allegations are promptly provided to the Intelligence Unit Manager for immediate notification and investigation of these incidents.

For Q3 of 2016, there were a total of 67 hotline calls. Of those 67 calls, 33 PREA related calls were placed and 34 calls were reported on the Crime Tips Hotline.

GEX monitored 37 (55%) of the 67 hotline calls in the third quarter.

Inmate Inter-Communication Evaluation & Reporting

ICER was designed to proactively monitor all inmate phone communications providing automatic alerts of inmate to inmate communications that might otherwise have gone undetected. In January of 2016, GEX began monitoring and investigating ICER communications and reporting information to the Inspector General's Office. MO DOC averages 30 ICER calls a day, and approximately 10,236 ICER calls have been identified through June of 2016.

GEX monitored 2,322 ICER calls in Q3 of 2016. Suspicious conversations were identified in 195 of these calls and assigned to a GEX Investigative Analyst for further review. 54 reports were generated and provided to the OIG.

In August of 2016, MO DOC requested the GEX no longer pull ICER reports for call review, but may come across ICER calls through GEX bucket monitoring and will report these as 3-way calls moving forward.

ICER calls that were generated into SAR reports contained the following suspicious activity:

Assault	Extortion
Cell Phone	Prison STG Activity
Contraband	Self-Harm-Offender
DOC Violation	Staff Avoidable Contact
Drugs/Intoxicant	Threats-Civilian & Offender
Informational Purpose Only	Threats-Staff

Canine Contraband Detection Services

In September of 2015, MO DOC released a bid for Canine Contraband Detection Services. GEX responded and was awarded the contract in October of 2015. The contract provides all of Missouri Correctional Facilities access to a certified narcotics and cell phone detection dog, and handler, as needed to search designated areas of Missouri Institutions.

GEX purchased a Passive Alert Holland Sheppard named Ace and he was certified, along with Handler Jeff Hunter, at K9 Working Dogs International in the State of Kansas. K9 Working Dogs International is a DEA and STF Federally Licensed K9 Training Center and a global supplier of Police Service Dogs. Ace and Jeff completed a 120 hour 3-week Handler & K9 certification course - which exceeds National Certification and Initial Training Standards approved by the NAPWDA, MCPA, and USPCA.

A second contract was released in March of 2016 and, once again, GEX was awarded the new contract, effective July 1, 2016, which requires two (2) passive alert canines and two (2) certified handlers. After being awarded the new contract, GEX purchased a Belgian Malinois (Mal-in-wah) named Zeppi and Hannah Porter accepted the position of canine handler supplementing the Canine Detection Services Team. Hannah and Zeppi attended training at K9 Working Dogs International in the State of Kansas, and completed the K9 Narcotics Certification Course - which exceeds National Certification and Initial Training Standards approved by the NAPWDA, MCPA, and USPCA.

Jeff Hunter and Ace also received additional training at K9 Working Dogs. But this time, Jeff was certified to become a Trainer of Canine Detection Services, enabling him to certify other handlers and service dogs. Jeff received his Trainer Certification in July of 2016.

In Q3 of 2016, Jeff, Ace, Hannah and Zeppi were deployed to six Missouri Institutions and completed 15 searches:

South East Correctional Center on
07/06/2016 & 07/07/2016
South Central Correctional Center on
07/26/2016
South Central Correctional Center on
07/30/2016
Tipton Correctional Center on
08/05/2016
Moberly Correctional Center on
08/16/2016
Tipton Correctional Center on
09/02/2016
Farmington Correctional Center on
09/06/2016
Farmington Correctional Center on
09/12/2016 & 09/13/2016
Tipton Correctional Center on
09/16/2016
Alcoa Correctional Center on
9/19/2016
South Central Correctional Center on
9/21/2016
Farmington Correctional Center on
9/23/2016 & 9/24/2016



August of 2016 - Both handlers and canines were invited to the annual meeting held by the Office of the Inspector General. The handlers provided a description of each dog's discovery skills.

Canine Search Results

On 07/06/2016 both K9 Teams were requested at SECC to search two wings of a housing unit. The K9's gave multiple positive alerts in both wings of this housing unit. Several contraband items were located and removed from the housing unit. It is unknown what contraband was found.

On 07/07/2016 both K9 Teams returned to SECC. Two wings of the work release housing unit were searched; as well as, the work release vans that returned later that day. The K9's gave several positive alerts in the housing unit and one positive alert on a work release van. It is unknown what contraband was recovered.

On 07/26/2016 both K9 Teams were requested at SCCC . The K9's searched employee belongings as they were entering and exiting the facility. The K9's also searched employee offices, restrooms and closets. Both K9's gave multiple positive alerts in the offices and on staff belongings. K9 Zeppi had multiple positive alerts in the investigators office where product (evidence) was located. K9 Ace had a positive alert on a cell phone that had been placed in an evidence bag as well. The power plant and training class trailer, outside of the facility, were also searched. It is unknown what contraband was found.

On 07/30/2016 one K9 Team was requested for a follow up at SCCC. The search started at 0800 hours to search belongings of the morning shift coming into the facility. K9 Ace gave a positive alert on a set of keys but nothing was found. K9 Ace was 100% on all hides placed throughout the search. The search concluded at approximately 0715 hours.

On 08/05/2016 both K9 Teams searched two housing units at TCC. There were multiple positive alerts given by both K9's. Several contraband items were recovered and taken into evidence. Items will be tested later for narcotics. There were no cell phones recovered during the search. Both K9's were 100% on all hides placed throughout the search.

On 08/16/2016 both K9 Teams were requested to MCC for a search of the facility as well as areas outside of the facility. Areas searched included a minimum-security housing unit, the yard in front of the main entrance to the prison, the garage, the power plant, the laundry facility and the septic treatment plant. There were several alerts given by both K9's. Some of the alerts given confirmed prior intelligence from prison staff. It is unknown if any contraband was discovered. Both K9's were 100% on all hides placed throughout the search.

On 09/02/2016 both K9 Teams were requested at TCC for a search of the gym, the outside track area and education building. Multiple alerts were given by both K9's. Some prescription medication was in the education building where one of the K9's alerted. It is unknown if any other contraband was recovered.

On 09/06/2016 both K9 Teams were requested at FCC for a search of a housing unit. Multiple alerts were given by both K9's. There were several contraband items recovered including a brown work glove that contained, what is believed to be, methamphetamine. It is unknown if any other contraband was recovered.

On 09/12/2016 both K9 Teams arrived at FCC for a search of a housing unit. Multiple alerts were given by both K9's throughout the search. Several items of interest were recovered. It is unknown now what the contraband items that were recovered were. Both K9's were 100% on all hides placed throughout the day.

On 09/13/2016 both K9 Teams returned to FCC for a search of a housing unit. Multiple alerts were given by both K9's throughout the search. Several contraband items were recovered, but It is unknown now what was located. Both K9's were 100% on all hides.

On 09/16/2016 both K9 Teams were requested at TCC for a night search of a housing unit. Multiple alerts were given by both K9's. The CERT Team was activated to search the housing unit after the K9 Teams completed their search. It is unknown now what contraband was recovered. Both K9's were 100% on all hides placed throughout the search.

On 09/19/2016 both K9 Teams, along with a K9 Team from Cole County, were requested at ACC to search housing unit 16. Multiple alerts were given by all K9's. The CERT Team was activated to search all areas after the K9 search. It is unknown what contraband was discovered. The recreation area was also searched and multiple alerts were given. Both GEX K9's were 100% on all hides placed throughout the search.

On 09/21/2016 both K9 Teams reported back to SCCC to complete cell searches in housing unit 5, the laundry facilities and a warehouse. Multiple alerts were given by both K9's. A SIM card was located in a cell where a K9 alert was given. A green leafy substance, believed to be Marijuana, was also found in a separate cell where a K9 alert was given. There were multiple alerts given in the laundry facility and in the warehouse, but it is unknown what contraband was discovered during the search. Both K9's were 100% in all hides placed throughout the day.

On 09/23/2016 both K9 Teams were requested at FCC for a search of the education building, mattress factory and clothing issue. Multiple alerts were given during the search. Several unknown items were taken as evidence for later testing. Both K9's were 100% on all hides placed throughout the day.

On 09/24/2016 both K9 Teams were requested at FCC for a search of the visitation rooms, the maintenance buildings and the green house area. Multiple alerts were given throughout the search. It is unknown what contraband was discovered. Both K9's were 100% on all hides placed throughout the day.

Monitoring Highlights

Contract to Date Call Volume

MO DOC Offenders have placed over 73 million calls (73,558,616) on the Secure Call Platform from November of 2011 through September of 2016.

Since monitoring began in November 2011, Guarded Exchange has monitored over 3.6 million calls (3,676,721) (5.00% of the total call volume) through September 2016.

Call Volume

In Q3 of 2016, MO DOC offenders placed over 4.4 million calls (4,430,005). Guarded Exchange monitored a total of 223,189 (5.04%) calls.

Call volume has *increased* by 13.50% in Q3 of 2016 when compared to Q3 of 2015 - a total of 3,902,923 calls were made in Q3 of 2015.

Average call duration in Q3 of 2016 decreased to 9.68 minutes/call from 10.21 minutes/call in Q3 of 2015.

Information Highlights

GEX Communication Analysts document Content Based Identification (CBID) by using the content of a phone call to assist in verifying a subject's identification. When a person on the phone addresses the other by name or alias, confirms their relationship to one another, or when an offender's date of birth is verified. When one of these is mentioned, the GEX Communication Analyst auditing the call then verifies the CBID information through available tools.

GEX also collects phone and confirmation numbers provided during phone conversations. This information is then stored in our system and can be used to identify offenders that are personal identification number (PIN) sharing, identify offenders or civilians by alias names, and locate additional information based on phone numbers or wire transfer confirmation numbers from our searchable database.

GEX has obtained a total of 173,481 CBID's and verified voice prints for 52,470 offenders.

In Q3 of 2016, GEX obtained 11,245 CBID's and verified voice prints for over 5,600 offenders. Approximately 6,587 phone numbers were collected. An average of 3% of overall calls, monitored during Q3 of 2016, contained a phone number provided by the offender or civilian over the phone.

GEX has also added any verified alias names into the Corrections Information Network (COIN) to ensure everyone has access to the identifying data.

Report Origins

Reports by Origin

In Q3 of 2016, GEX provided a grand total of 307 Informational reports to the Office of the Inspector General.

- 149 of these reports originated from calls generated by the GEX queue.
- 7 of these reports were requests from Access Corrections (AC), the contracted Fund Deposit Company. This includes individual requests and reports compiled based on chargeback requests from AC.
- 42 reports of these reports were generated from Requests for Investigative Assistance from the Intelligence Unit Manager.
- 54 of these reports were generated from calls monitored from a request to Saturate specific facilities (9 total requests).
- 1 of these reports report was generated from Language Translation requests.
- 54 of these reports were generated from ICER alerts.

Requests for Investigative Assistance

During Q3 of 2016, there were 42 Individual Requests from the Inspector General's Office. Some of these requests were to assist in identifying:

- Information in regards to how Controlled Substances might be Introduced into an Institution
- Information in regards to Offender Substance Abuse (Heroin & Methamphetamines)
- Information in regards to Possible Staff Misconduct
- Information in regards to Drug Conspiracies
- Information in regards to Assaults
- Information in regards to Drug Trafficking
- Information in regards to STG Attack on Staff
- Information in regards to an Incident occurring between STG Members
- Information in regards to an Escape
- Information in regards to Extortion
- Information in regards to Credit Card Fraud
- Information in regards to Cellular Phone locations
- Information in regards to Drugs being Introduced via the Visitation Rooms

Translation Requests

In Q3 of 2016, there was 1 request to monitor and translate calls for multiple offenders and specific phone numbers. This request was received from an Investigator II, regarding several offenders that are suspected of introducing controlled substances into a Missouri Institution. A total of 456 calls were monitored with over 138 hours of call durations. This request was closed on 9/19/2016 and violations were given to the offenders involved.

Saturation Requests

GEX received a total of 9 Saturation Requests in Q3 of 2016. These requests include:

- Monitor specific housing units to locate information of a possible disturbance at JCCC.
- Monitor a specific housing unit to identify any information regarding offenders attempting to introduce K-2 and marijuana into FCC.
- Monitor specific housing units due to receiving information of possible tension on the rise at SECC.
- Monitor specific housing units at MECC - listening for any information related to drug trafficking and any information related to possible staff issues or concerns.
- Monitor a specific housing unit at WMCC due to the amount of drug interdictions and information from offenders regarding continued usage.
- Monitor calls placed by specific offenders due to possible drug trafficking and offenders testing positive for methamphetamines at SECC.
- Monitor calls placed by specific WMCC offenders that are sending green checks and listen for any illicit behaviors or attempts to conspire to introduce.
- Monitor calls placed from a specific WMCC Housing Unit. This is 2 separate requests with different housing units requested. Listening for any of the following:
 - Any suspicious conversation for drugs, cell phones or staff contact
 - Talk of stockpiling canteen items
 - Talk of not speaking to relatives for long periods of time ("Might be a while before you hear from...")
 - Talk of going to the hole
 - Talk of high tensions at the facility between staff or other offenders
 - Talk of possible assaults of staff or other offenders
 - Talk of potentially destroying property
 - Talk of the anniversary of Attica
 - Talk of work stoppage or plans of sit-downs/sit-ins

A total of 54 reports were generated from the above requested saturations.

These reports include information regarding the following occurrences:

Assaults (1)	Self-Harm-Offender (1)
Cell Phone (2)	Sexual Offense (1)
Contraband (5)	Staff Avoidable Contact (1)
DOC Violation (14)	Threats-Civilian (2)
Fraud (1)	Threats-Offender (3)
Drugs/Intoxicants (19)	Outside Law Enforcement (4)

Financial Reports and Emails

Access Corrections provides MO DOC with Offender Deposit and Email Services. Access Corrections provides GEX with a monthly chargeback report. GEX then monitors and researches these charge backs to verify if any fraudulent charges have been attempted or made. Guarded Exchange also monitors individual requests from Access Corrections.

In Q3 of 2016, GEX submitted a total of 7 reports from Access Corrections data. GEX received 5 specific requests from Access Corrections to consider possible fraudulent financial transactions and 2 additional reports were generated from information obtained through monitoring chargeback calls. Calls were monitored and financial transactions and emails were reviewed for all requests.

Information identified from the 5 separate requests are listed below:

- 3 separate offenders are believed to be involved in credit card theft conspiracy.
- In 2 separate requests, offenders directed family members to send money to pay off debt owed on the offender's books to purchase items from canteen.
- Assistance was requested to identify a suspect in a large fraud investigation. This suspect was identified and provided to Access Corrections.
- Possible Fraud (\$2,000+). It was identified that 3 separate parolees are fraudulently using credit cards and sending money to other offenders. A parolee was also identified as making threatening statements regarding her mental health. The portion of this report which contained the credit card fraud was provided to Access Corrections. The information regarding the parolee's threatening statements was provided to the OIG office and was then reported to the PPO.

GEX has received 207 charge backs in Q3 of 2016, with 2 reports generated from researching these requests. Both reports were provided to OIG and then to outside law enforcement.

- 1 report contained information regarding a Parolee that murdered two civilians in 2007.
- The second report contained information regarding a civilian using another person's credit card (\$250+) without their consent.

GEX started monitoring offender emails in August of 2015 for suspicious content. Below is a breakdown of emails monitored during Q3 of 2016.

July 2016

Total Emails sent = 79,243
Total Emails read = 3,962 (5.00%)

August 2016

Total Emails sent = 83,921
Total Emails read = 4,197 (5.00%)

September 2016

Total Emails sent = 82,875
Total Emails read = 4,187 (5.06%)

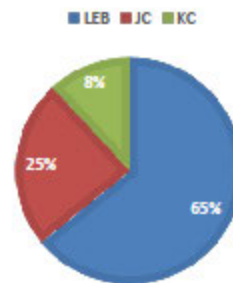

Submitted Reports by Office

Guarded Exchange Offices are located in Jefferson City, Lebanon, and Kansas City, Missouri. These three offices have part and full time Communication Analysts on staff. The Lebanon office reported 85% of the overall information provided to the Inspector General's Office. Lebanon also staffs 45% of our Communication Analysts.

Information Distribution

In Q3 of 2016, GEX sent a total of 149 reports to the OIG that were generated from the **Guarded Exchange** queue.

- 29 of these reports were sent to the corresponding facility administration due to rule violations by offenders (Drugs/Intoxicants, Threats and Assault)
- 116 of these reports were assigned to the Investigators in the OIG for investigation due to suspicious activity found
- 3 of these reports were sent to outside agencies.

149 does not include the Language Translation requests, Saturation requests, Access Corrections Requests, or Requests from OIG

Reports Distributed to Social Services and Various Other Agencies

The Missouri Department of Social Services (DSS) is responsible for coordinating programs to provide public assistance to children and their parents, access to health care, child support enforcement assistance and to provide specialized assistance to troubled youth.

The DSS Family Support Division assists families with food stamps, health care, child care and child support. Helping to preserve the integrity of the public assistance programs Missouri DSS provides, GEX reports any suspected fraud.

As a mandated reporter, GEX also provides any suspected abuse (Child or Elderly) to the OIG. Information that may assist various law enforcement agencies is also documented and provided to the OIG and then disseminated to the respective agencies.

In Q3 of 2016, there were not any informational reports that were forwarded to the Department of Social Services.

There were a total of 3 Informational Reports submitted by GEX that were provided to outside law enforcement, by the OIG, in Q3 of 2016. These reports contained information, including but not limited to:

- An inmate in a county jail attempted to smuggle contraband (earrings & ponytail holders) into the County Jail from her court hearing.
- Information regarding a civilian stabbing a male civilian and that she needed to hide or people would try to kill her. This information was provided to a detective at the local police department.
- A civilian was making suicidal statements and this information was provided to the County Sheriff's Department.

Report Outcomes

Once GEX Investigators reach reasonable suspicion during an investigation, an Informational Report is completed and sent to the Intelligence Unit Manager. From there, the Intelligence Unit Manager distributes the Report to the appropriate Law Enforcement Agency or Department.

Report Topic Breakdown

Offender phone calls can contain a wide variety of information. Some calls contain data associating an offender with a conduct violation of some sort, such as using other offenders PIN without permission or possession of contraband in their cell. In more serious cases, information may lead to potential harm to staff or other offenders, conspiracy to introduce a controlled substance, possession of a cellular phone or threat of an assault.

Breakdowns of the Top 10 Report Topics are available in the graphic below.

- 36% of the reports for Q3 of 2016 contained information believed to be an attempt to introduce drugs or be in the possession of drugs in a Missouri Institution.
- 15% of the reports submitted contained information regarding offenders in possession of contraband or received a DOC violation.

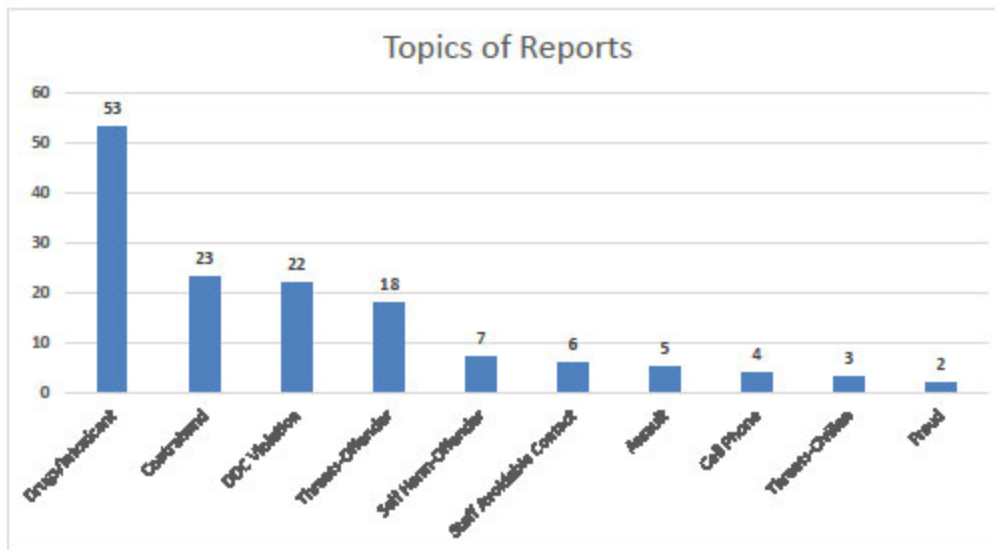

OIG Findings for GEX Reports

A monthly case review is completed to locate any updates on the outcome of reports submitted by GEX.

Below are the counts of the updates located in Q3 of 2016.

- 58% of reports submitted by GEX were sent to Administration.
- 13% of the reports resulted in the offender receiving a conduct violation.
- 9% of the reports submitted by GEX were found to be inactive.

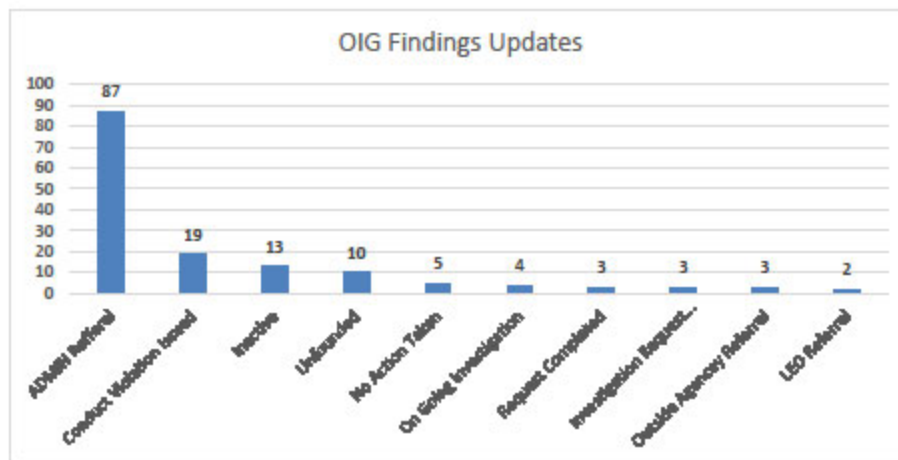

Forensics Highlights

Guarded Exchange currently employs Cellebrite UFED Touch Certified users; as well as, a Certified Digital Forensic Examiner and a Missouri Private Investigator with over 7 years of experience in the field of data extraction, data analysis and cybercrime. With this unique resource and experience, GEX can extract data from the most difficult of devices.

GEX Forensics Services also utilize numerous industry standard Computer Forensic programs (Encase, Internet Evidence Finder, Passware, Oxygen Phone Forensic Suite, Forensic Explorer) that are also able to perform data extraction on mobile devices as well as other Forensic software. This is to perform in depth forensic analysis on images acquired from devices as well and any form of digital media, at no additional charge to the agency.

In October of 2016 Guarded Exchange Forensics Lab staff became certified to perform Chip-Off Forensics.

With the class and equipment provided by H-11 Forensics, GEX can now perform data extraction on devices that are damaged, locked or unsupported by other forensic tools.

Chip-Off Forensics is the process of removing the flash memory from the printed circuit board of a device using either a No Heat method or Heat method, depending on the purpose of the extraction, reading and analyzing the raw data stored on the chip.

The ability to perform this process will allow GEX access to more locked and damaged devices than ever before; thus, adding to the potential of vital intelligence and data gathered from devices.

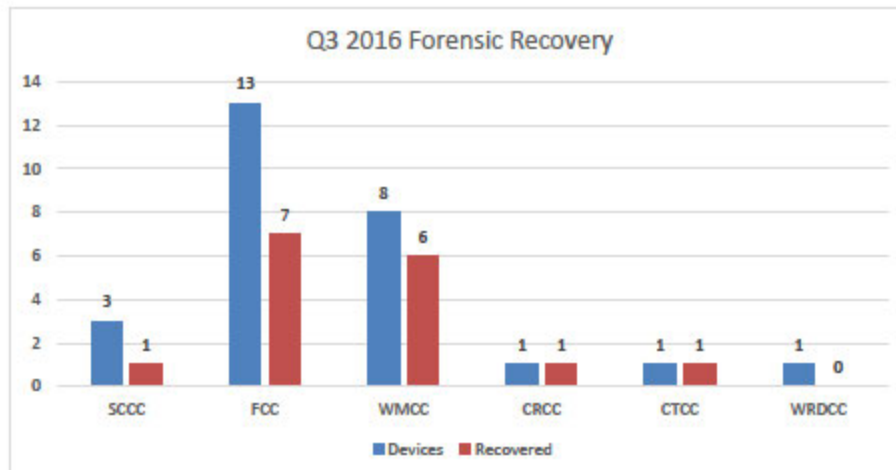

Guarded Exchange analyzed data on 27 devices from MO DOC Institutions, with data recovered on 82% of the devices provided.

Please note that 3 devices are pending extraction completion. 1 of the 3 has been sent off for Chip-Off extraction

Missouri Corrections Association



The 2016 Missouri Corrections Association Conference was held at The Lodge of Four Seasons, Lake of the Ozarks, Missouri, on September 28, 2016 and concluded on September 30, 2016.

Attendees included: MO DOC Wardens, Securus, Guarded Exchange, JPay and JLG. One of the GEX K9 Teams was also in attendance (K9 Zeppi and Handler Hannah Porter).

The Missouri Corrections Association (MCA) promotes and supports the corrections profession by strengthening and uniting its members through combined effort and communication with other Regional, State and National Corrections Organizations and provides leadership to achieve success in impacting the lives of those we serve.

Requested Documentation

Equipment List / Spec Sheets

Equipment List	
Item	Model
Tablets	JP5S – Pre-loaded 7 inch tablet
Routers	Netvanta 3140
Switches	Netvanta 1531
UPS	Eaton 3S750
Wireless Access Points	Ruckus
Servers	SLP1
Charging Stations	Tripplite CSC64MICROUSB
Surge Suppressors	Panamax #M4KSU
Telephone	
Phones	Wintel 7042 and Wintel 7010
Handsets	24" Duraclear
TDD Phones	Krown PV 20
Routers	Adtran 924E
Switches	Netvanta 1531
UPS	Eaton 3S750
UPS	Eaton 5PX1500RT
Surge Suppressors	Panamax #M4KSU
Workstations	Dell Optiplex 3040
PC Monitors	Dell 1908FP
Printer	HP Envy 4520
Misc	Equipment racks and shelves, roll around phone carts



Eaton 5PX UPS

Enterprise class battery backup with extended runtime designed for virtualized environments.

5PX features and benefits:

Extended Runtime: Add up to four extended battery modules for maximum runtime.

Virtualization-ready: Available in convenient bundles with a network card and management software for rapid integration into your virtual environment.

Efficiency: Provides industry leading efficiency of up to 99 percent.

Manageability:

- **Energy metering:** The 5PX meters energy consumption right down to the outlet segments. No other UPS in the industry offers this capability.
- **UPS management:** By integrating the Eaton Intelligent Power Manager software, you can monitor and manage the power devices on your network.

LCD display: Eaton's next generation LCD offers a graphical interface which provides all critical UPS information in a single screen view.

More power: Protects more devices by providing 28 percent more wattage compared to traditional UPSs.

Battery life: Eaton's exclusive ABM® technology increases battery service life by 50 percent.

Intelligent Power Manager (IPM)

By integrating IPM with the Eaton 5PX, you can:

- Remotely monitor and manage multiple devices across your network from a single interface; this can be integrated into an already existing platform, such as VMware, Microsoft or Citrix
- Suspend non-critical virtual machines, consolidate critical virtual machines and shut down unused servers to extend battery runtime.
- Set server power consumption limits for extended battery runtime with UCS management software

To learn more, please visit:

Eaton.com/intelligentpower

Services and support

Eaton provides product support 24 hours a day, 7 days a week. From battery replacement to full UPS service plans, Eaton has one of the top service models in the industry.

Three-year warranty

The 5PX warranty covers both the UPS and the batteries for three years.



The Eaton 5PX is an ENERGY STAR® qualified UPS. ENERGY STAR is intended to help consumers save money and protect the environment through energy efficient products and practices.



5PX MODEL SELECTION GUIDE*

Catalog Number	Rating (VA / watts)	Input connection	Output receptacles	Dimensions (H x W x D), in	Net weight, lb
120V, 50/60 Hz					
5PX1000RT	1000 / 1000	5-15P	(8) 5-15R	3.4 x 17.4 x 20.6	62
5PX1500RT	1440 / 1440		65		
5PX2200RT	1950 / 1920	5-20P	(8) 5-20R	3.4 x 17.4 x 25.4	65
5PX3000RT2U	3000 / 2700	L5-30P	(1) L5-30R		87
5PX3000RT3U			(8) 5-20R	86	
208V/230V, 50/60 Hz					
5PX1500iRT	1500 / 1350	C14-10A	(8) C13-10A	3.4 x 17.4 x 20.6	61
5PX2200iRT	2200 / 1980	C20-16A	(1) C19-16A		63
5PX3000iRT2U	3000 / 2700		(8) C13-10A	3.4 x 17.4 x 25.4	84
120V, 50/60 Hz Virtualization-ready bundles with Network Card-MS					
5PX1500RT N	1440 / 1440	5-15P	(8) 5-15R	3.4 x 17.4 x 20.6	65
5PX2200RT N	1950 / 1920	5-20P	(8) 5-20R	3.4 x 17.4 x 20.6	65
5PX3000RT N	3000 / 2700	L5-30P	(8) 5-20R, (1) L5-30R	3.4 x 17.4 x 25.4	87
208/230V, 50/60 Hz Virtualization-ready bundles with Network Card-MS					
5PX3000iRT N	3000 / 2700	C20	(8) C13, (1) C19	3.4 x 17.4 x 25.4	84
Extended Battery Modules					
	DC voltage	For use with	Max qty / UPS	Dimensions (H x W x D), in	Net weight, lb
5PXEBM48RT	48V	All 1000, 1500 & 2200 models	4	3.4 x 17.4 x 20.6	72
5PXEBM72RT2U	72V	All 2000 2U models		3.4 x 17.4 x 25.4	102
5PXEBM72RT3U		All 3000 3U models		5.1 x 17.4 x 19.6	98

*Due to continuous product improvement programs, all specifications are subject to change without notice. Please visit Eaton.com/5PX to view complete and updated product specifications.

Additional Options	Catalog Number	For use with
Connectivity		
Network Card-MS	NETWORK-MS	All models*
Environmental Monitoring Probe	118750224-001	All models (requires Network Card-MS)
Power Distribution & Bypass		
HotSwap Maintenance Bypass (MBP) The HotSwap Maintenance Bypass allows you to exchange or service the UPS without shutting down the connected load	EHBPL1500R-PDU1U EHBPL2000R-PDU1U EHBPL3000R-PDU1U	All 1000 & 1500 models All 2200 models All 3000 models
Mounting Hardware		
2-post rail kit	103007019-5591	All models

* Network Card-MS is included with catalog numbers 5PX1500RTN, 5PX2200RTN, 5PX3000RTN and 5PX3000iRTN.

What's in the box

- Tower pedestals
- Four-post rail kit
- User manual CD
- Quick start guide
- USB cable
- RS-232 serial cable
- Phillips Head screw driver
- 2 IEC to IEC jumper cables (208V/230V models)

5PX UPS rear panel (1000 & 1500 VA)



Battery runtime

You can get up to five hours of battery runtime using the internal batteries and extended battery modules. For a detailed, interactive battery runtime chart, please visit: Eaton.com/5PX (View the individual technical pages for details of each UPS.)

To interact with the Eaton 5PX UPS, please visit Eaton.com/5PX



Eaton
1000 Eaton Boulevard
Cleveland, OH 44122
United States

Eaton.com

©2015 Eaton
All Rights Reserved
Printed in USA
5PX01 FNA / GG
May 2015



Eaton is a registered trademark.
All other trademarks are property of their respective owners.

ENERGY STAR and the ENERGY STAR mark are registered U.S. marks. ENERGY STAR is a registered mark owned by the U.S. government.



Dell | Displays

Quality

Dell-branded monitors are designed to our exacting quality standards and manufactured by the world's foremost suppliers, who must pass Dell's stringent quality audit. All Dell monitors meet or exceed relevant industry standards.

Reliability

Dell-branded monitors undergo exhaustive testing for performance, reliability, durability and compatibility with Dell systems. Under our H.A.L.T (Highly Accelerated Life Cycle Testing) regimen, Dell engineers push our monitors well past specified tolerance limits for heat, cold, vibration, shocks and drops, to ensure that they can withstand real-world conditions.

Price-Performance Value

Dell's enormous buying power and direct business model allows us to offer high quality monitors at low prices. Dealing with Dell, the world's largest Flat Panel provider¹, means a single point of contact and accountability, and the peace of mind of purchasing from a stable and reliable technology partner.

Dell™ UltraSharp™ 1708FP and 1908FP, 17"/19" flat panel LCD displays carry forward the value proposition of 1707FP / 1907FP incorporating many advanced features for great performance and ease of use. These two performance flat panel displays have a sleek black Dell industrial design and an improved stand design is designed to enhance your viewing experiencing.

Outstanding Screen Performance

• UltraSharp™ 17" / 19" Screen Size

- 1708FP: About 31% more viewing area than Dell E157FP.²
- 1908FP: About 25% more viewing area than Dell 17" flat panel displays.³

• Fast response time with less smearing and ghosting than traditional flat panel displays.

- 1708FP / 1908FP ~ 5ms (typical)

• High contrast ratio resulting in excellent color accuracy and uniformity.

- 1708FP / 1908FP ~ 800:1 (typical)

• High Resolution can provide excellent entertainment and multimedia experience.

- 1708FP / 1908FP (1280 x 1024 resolution): About 66% more content compared to Dell E157FP monitor.⁴

Excellent Multimedia, Video and Graphics Experience

• DVI (Digital Video Interface) connector helps to ensure high quality image (no jitter).

• Easy attachment of optional Dell 10W multimedia soundbar AS501.

Designed for Comfort and Convenience

• 4 USB 2.0 high speed ports for easy access to connect peripheral devices such as cameras, USB keys or mouse.

• Comprehensive flexibility of height adjustability (130mm up or down), swivel (45° left and right) and tilt (4° forward and 21° backward).

• Dell-Designed Display Enhancements

- Slim black bezel designed to fit into most working environments and on most desktops.

- Easy display detachment from stand can enable panel to be wall-mounted (VESA standard 100mm, wall mount sold separately.)

See Important Information on Page 3



DETAILED SPECIFICATIONS

Product Category	Flat Panel Display	Flat Panel Display
Model Name and Number	1708FP	1908FP
Monitor Size (Viewable Image Screen)	17 Inches (17-inch)	19 Inches (19-inch)
Pixel Pitch	0.264mm	0.294mm
Response Type (Typical)	5ms	5ms
Preset Display Area:		
Horizontal	337mm (13.3 inches)	380mm (14.96 inches)
Vertical	270mm (10.6 inches)	300mm (11.81 inches)
Viewing Angle (Typical)	160° (vertical), 160° (horizontal)	160° (vertical), 160° (horizontal)
Luminance (Brightness)	300cd/m ² Typical	300cd/m ² Typical
Contrast Ratio (Typical)	800:1	800:1
Horizontal Scan Frequency kHz	30 kHz to 81 kHz (automatic)	30 kHz to 81 kHz (automatic)
Vertical Scan Frequency Hz	56 Hz to 76 Hz (automatic)	56 Hz to 76 Hz (automatic)
Optimal Resolution	1280 x 1024 at 60 Hz	1280 x 1024 at 60 Hz
Preset Display Modes:		
VESA, 720 x 400	31.5 kHz Horizontal, 70.0 Hz Vertical), 28.3 MHz	
VESA, 640 x 480	31.5 kHz Horizontal, 60.0 Hz Vertical), 25.2 MHz	
VESA, 640 x 480	37.5 kHz Horizontal, 75.0 Hz Vertical), 31.5 MHz	
VESA, 800 x 600	37.9 kHz Horizontal, 60.3 Hz Vertical), 49.5 MHz	
VESA, 800 x 600	48.9 kHz Horizontal, 75.0 Hz Vertical), 49.5 MHz	
VESA, 1024 x 768	48.4 kHz Horizontal, 60.0 Hz Vertical), 65.0 MHz	
VESA, 1024 x 768	60.0 kHz Horizontal, 75.0 Hz Vertical), 78.8 MHz	
VESA, 1152 x 864	67.5 kHz Horizontal, 75.0 Hz Vertical), 106 MHz	
VESA, 1280 x 1024	84.0 kHz Horizontal, 60.0 Hz Vertical), 135 MHz	
VESA, 1280 x 1024	80.0 kHz Horizontal, 75.0 Hz Vertical), 135 MHz	
Connector Type	Analog, DVI-D (Digital)	Analog, DVI-D (Digital)
Other Connectors / Features	4 Universal Serial Bus (USB) 2.0 Ports, Kensington security port	4 Universal Serial Bus (USB) 2.0 Ports, Kensington security port
Stand	Tilt, Swivel, Pivot, Height Adjustable	Tilt, Swivel, Pivot, Height Adjustable
VESA Mounting Support	YES (100mm)	YES (100mm)
Dimensions (H x H x W x D) Inch	18.25 (extended) x 13.13 (compressed) x 14.65 x 7.17	19.39 (extended) x 14.26 (compressed) x 16.15 x 7.17
Dimensions (H x H x W x D) mm	463.6 (extended) x 333.6 (compressed) x 372.11 x 182	492.6 (extended) x 362.6 (compressed) x 410.1 x 182
Weight with stand assembly and cables	5.17 Kg (11.39 lb)	5.74 Kg (12.64 lb)
Weight with packaging	6.7 Kg (14.76 lb)	7.4 Kg (16.3 lb)
AC Input voltage	100 to 240 VAC / 50 Hz / 60 Hz + 3 Hz / 2.0A (Max.)	100 to 240 VAC / 50 Hz / 60 Hz + 3 Hz / 2.0A (Max.)
Operating (Typical Maximum)		
- Active Off	Less than 2W	Less than 2W
- Switched Off	Less than 1W	Less than 1W

Recycling: Dell recommends that customers dispose of their used computer hardware, including monitors, in an environmentally sound manner. Potential methods include reuse of parts or whole products and recycling of product, components and/or materials. For more information, please visit http://dell.com/recycling_programs and www.dell.com/environment.



Dell cannot be held responsible for errors in typography and photography.

1. DisplaySearch Q3 2006 Quarterly Desktop Monitor Report, "No.1 Worldwide LCD Monitor Shipment Branding Ranking for Q2 2006", August 2006.
2. 31% more viewing area claim: Viewing area comparison based on Dell E157FP area of $\sim 69,365\text{mm}^2/106\text{sq. in.}$ ($\sim 304.1\text{mm}/11.9''$ Length x $228.1\text{mm}/8.9''$ Height) and Dell UltraSharp 1708FP area of $\sim 90,990\text{mm}^2/141\text{sq. in.}$ ($\sim 337\text{mm}/13.3''$ Length, $270\text{mm}/10.6''$ Height).
3. 25% more viewing area claim: Viewing area comparison based on Dell E177FP area of $\sim 90,990\text{mm}^2/141\text{sq. in.}$ ($\sim 337\text{mm}/13.3''$ Length x $270\text{mm}/10.6''$ Height) and Dell UltraSharp 1708FP / 1908FP area of $\sim 114,000\text{mm}^2/177\text{sq. in.}$ ($\sim 380\text{mm}/14.96''$ Length, $300\text{mm}/11.81''$ Height).
4. 66% more content area: Content comparison based on Dell E157FP pixel count of 786,432 (1024 Horizontal x 768 Vertical) and Dell UltraSharp 1708FP / 1908FP pixel count of 1,310,720 (1280 Horizontal x 1024 Vertical).

Dell and the Dell logos are trademarks of Dell Inc. Dell disclaims propriety interest in the marks and names of others. Copyright 2007 Dell Inc. All rights reserved.



NetVanta 1531

Layer 3 Lite Gigabit Ethernet Switch

Product Features

- 12-port multi-layer Gigabit Ethernet switch
- Ten 10/100/1000Base-T Ethernet ports and two 1 Gbps Small Form-factor Pluggable (SFP) optical ports
- Fanless design for quiet operation
- Non-blocking, up to 24 Gbps switching capacity
- Line rate Layer 2 and Layer 3 Lite capabilities
- 16 static routes
- 802.1Q VLANs, Private VLANs and VLAN assignment via 802.1x
- VoIP Setup Wizard
- Advanced Quality of Service (QoS) with support for 802.1p and DiffServ prioritization with four queues per egress port
- Automate actions with Port Scheduler and TCL scripting
- VoIP ready with LLDP/LLDP-MED and voice VLANs
- Business-class security with RADIUS, TACACS+, 802.1x and port security
- Optimized for iSCSI Storage Area Networks (SANs) solutions
- Wi-Fi[®] access controller for centralized management of NetVanta Wireless Access Points (WAPs)
- Cable and SFP diagnostics provides easy to use troubleshooting tools for copper and fiber cable
- Familiar CLI and Web GUI
- Limited lifetime warranty
- Next business day advance replacement

NetVanta[®] 1531 is a managed, 12-port, Layer 3 Lite, Gigabit Ethernet switch designed as an access layer switch for small businesses and branch office deployments. With the combination of the advanced multi-layer switching fabric, high-bandwidth capabilities, and enhanced QoS features, the NetVanta 1531 is ideal for Voice over IP (VoIP), Gigabit-to-the-desktop and converged voice and data deployments. Experience ease of management with Web-based Graphical User Interface (GUI) and familiar Command Line Interface (CLI).

Hardware

The NetVanta 1531 is a desktop, wall mountable or rack mountable switch with a fanless design ensuring quiet operation. It provides 12 Gigabit Ethernet ports, consisting of 10 fixed 10/100/1000Base-T Ethernet ports and two 1.0 Gbps SFP ports. With two interconnected NetVanta 1531 switches mounted in a 19-inch rack (using the optional dual mounting tray), you can scale to twenty GigE ports, and up to four Gbps of backplane capacity, when using the SFP ports.

Multi-layer Switching

The NetVanta 1531 supports advanced multi-layer (Layer 2 and Layer 3 Lite) switching with up to 16 static routes allowing it to easily scale from SMBs to enterprise-size networks.

VoIP Ready

The NetVanta 1531 is VoIP-ready with the ability to automatically configure IP phones using LLDP-MED, and the ability to separate voice traffic onto voice VLANs, to simplify the deployment of VoIP. In addition, the switch includes a VoIP Setup Wizard (available via a web-based GUI or CLI), which automates the complete VoIP setup process reducing deployment time and eliminating errors. An on-demand VoIP report provides a printable summary of the switch VoIP configuration, as well as providing alerts and recommendations to improve performance. All NetVanta switches support QoS to prioritize VoIP traffic, 802.1p and DiffServ Class of Service (CoS).

Security

The NetVanta 1531 offers a variety of data security features including DoS protection, MAC-based port security, multilevel user passwords, Secure Shell (SSH) and Secure Socket Layer (SSL) for encrypted user login, and Access Authentication and Authorization (AAA) for authentication with RADIUS and TACACS+. With features such as 802.1x and port security, administrators can assure that only authorized users are allowed access to the network.

The ADTRAN[®] Operating System (AOS) also features desktop auditing using DHCP in conjunction with Microsoft Network Access Protection (NAP) protocol to monitor the health of client computers. The two protocols work together to ensure that systems connected to the network are using appropriate corporate policies, such as firewall settings, antivirus settings and other client health information.

Port Scheduler

NetVanta 1531 allows ports to be enabled or disabled based on time of day. This ability to schedule available ports allows for added security and can provide less power consumption during off hours, saving on utility cost.

iSCSI Optimized

All ADTRAN NetVanta Gigabit Ethernet switches are optimized for iSCSI SAN deployments. Network administrators can take advantage of features such as Jumbo frame support (up to 9K), separation of iSCSI network traffic utilizing VLANs, and 802.3x flow control to seamlessly integrate ADTRAN switches with iSCSI SANs devices.

Administration

AOS offers both a CLI and an intuitive Web-based GUI with step-by-step configuration wizards. For automating setup and configuration, NetVanta 1531 supports Auto-Config which provides the ability to automatically obtain the switch configuration via DHCP.

AOS also offers network forensics to aid in troubleshooting network problems by allowing network administrators to easily locate devices on the network by MAC or IP address.





ADTRAN, Inc.
Attn: Enterprise Networks
901 Explorer Boulevard
Huntsville, AL 35806
P.O. Box 140000
Huntsville, AL 35814-4000
256 963-8000
256 963-8699 fax

General Information
800 9ADTRAN
info@adtran.com
www.adtran.com

Pre-Sales Technical Support
888 423-8726
application.engineer@adtran.com
www.adtran.com/pre-sales

Post-Sales Technical Support
888 423-8726
support@adtran.com
www.adtran.com/support

Where to Buy
888 423-8726
channel.sales@adtran.com
www.adtran.com/wheretobuy

ProServices™
888 874-2237
proservices@adtran.com
www.adtran.com/proservices

Global Inquiries
256 963-8000
256 963-6300 fax
international@adtran.com

ADTRAN believes the information in this publication to be accurate as of publication date, and is not responsible for error. Specifications subject to change without notice. ADTRAN, n-Command and Helix are registered trademarks of ADTRAN, Inc. and its affiliates in various countries. All other trademarks mentioned in this document are the property of their respective owners.

ADTRAN warranty duration and settlements vary by product and geography. For specific warranty information, visit www.adtran.com/warranty

ADTRAN products may be subject to U.S. export controls and other trade restrictions. Any export, re-export, or transfer of the products contrary to law is prohibited. For more information regarding ADTRAN's export license, please visit www.adtran.com/exportlicense



ADTRAN is an ISO 9001, ISO 14001, and a TL 9000 certified supplier.

91796870F1-40 July
Copyright © 2014 ADTRAN, Inc.
All rights reserved.

NetVanta 1531

Layer 3 Lite Gigabit Ethernet Switch

Product Specifications

Physical Interface

Ethernet Ports

- 10–10/100/1000Base-T
- 2–Standard 1 Gbps SFP ports
- Auto rate/duplex/MDI/MDI-X

Console Port

- DB-9, RS-232

Switching Performance

- Non-blocking Layer 2/3 Switching

Maximum Forwarding Bandwidth

- 24 Gbps

Layer 2 Support

- 802.1D Spanning Tree
- 802.1w Rapid STP
- 802.3ad Link Aggregation
- 8,000 MAC Addresses
- Jumbo Frames (9K)
- IGMP Snooping/Querier
- 802.3x Flow Control

Layer 3 Support

- 16 Static Routes
- 8 Layer 3 Interfaces
- UDP Relay
- 232 ARP Entries
- IPv6 Management

Diagnostics

- Port Mirroring
- LLDP (802.1AB)
- LLDP-MED
- Cable Diagnostics
- SFP Diagnostics
- Troubleshooting Page

Front Panel Status LEDs

- Power Status
- LAN: Link, Activity

Port Statistics

- Number of TX/RX Frames, Collisions, Errors

Quality of Service

- 802.1p and DiffServ
- Four Output Queues per Egress Port
- Weighted Round Robin (WRR)
- Strict Priority Scheduling

VLAN

- Port-based VLANs
- 802.1Q Tagged Trunked VLANs
- Voice VLANs
- Private VLAN Edge
- Dynamic 802.1x Assigned VLANs
- Support for up to 255 Active VLANs

Administration

- CLI (Console/Telnet/SSH)
- SNMP v3
- Web-based GUI (HTTP/SSL)
- SYSLOG
- n-Command® support
- Email Alerts
- RADIUS
- TACACS+
- TCL Scripting
- Auto Config
- Port Scheduler
- DHCP Network Forensics

Security

- Port authentication (802.1x)
- Port Security
- DoS Protection
- Hardware ACLs
- Microsoft Desktop Auditing

Wi-Fi Controller

- Controls up to 8 NetVanta WAPs

Environment

- Operating Temperature: 32° F to 122° F (0° C to 50° C)
- Storage Temperature: -4° F to 158° F (-20° C to 70° C)
- Relative Humidity: Up to 95%, Non-condensing

Physical

- Chassis: 1U, 1/2 Rack Width—Desktop, Wall Mountable or Rack Mountable (with Optional Rack Mount or Wall Mount Brackets or Dual Mount Tray)
- Dimensions: 1.7 in. x 8.4 in. x 11.1 in. (4.3 cm x 21.3 cm x 28.3 cm) (H x W x D)
- Weight: 3.5 lbs. (1.6 kg.)
- AC Power: 100–240 VAC, 50/60 Hz
- Power: 30 Watts, Max 2.5A

Agency Approvals

- FCC Part 15 Class A, UL/CUL 60950-1

Ordering Information

Equipment	Part No.
NetVanta 1531	1700570F1
NetVanta 1000BaseSX SFP Transceiver	1200480E1
NetVanta 1000BaseLX SFP Transceiver	1200481E1
NetVanta 1 Meter SFP Interconnect Cable	1200484G1
NetVanta 3 Meter SFP Interconnect Cable	1200484G3
Dual Mounting Tray	1700508F1
Wall Mount Brackets	1200884G1
19 in. Rack Mount Brackets	1700511F1



Total Access 900/900e Series

VoIP Multiservice Access Gateways

Product Features

- Seamless voice and data integration over VoIP-based network architectures
- Single and quad T1 IADs
- Up to 24 analog POTS interfaces
- DSX-1 for PBX connectivity
- Compatible with industry-leading soft switches and call agents
- Dynamic bandwidth allocation affords more efficient utilization
- Standardized G.729a voice compression requires less bandwidth per voice call
- Integral full-featured IP router for data support and Internet access
- Stateful inspection firewall for network security
- Quality of Service (QoS) for delay sensitive traffic like VoIP
- Command Line Interface (CLI) mimics industry *de facto* standard
- Network Address Translation (NAT) for IP Address Concealment
- Feature-rich ADTRAN Operating System (AOS)
- Rugged metal case
- Optional battery backup
- Industry-leading 10-year North American warranty



ADTRAN® offers a wide variety of solutions for converged voice/data services. Our new Total Access® 900 Series of SIP-based multiservice access gateways and the Total Access 900e Series of Multi-T1 SIP-based multiservice access gateways are the next generation of ADTRAN's industry-leading Integrated Access Devices. These new products are designed for carrier VoIP networks and feature all of the same robust routing and voice features of the widely deployed Total Access IADs, along with a host of new features and functions that enable cost-effective, reliable IP service delivery. These devices use the ADTRAN Operating System (AOS) to simplify management and administration. Multiple models offer flexibility for varied applications from PRI delivery and trunking services to hosted IP PBX offerings.

The Total Access 900 Series offers a single T1 network interface, while the Total Access 900e Series offers up to 4 T1s. User interfaces include up to 24 FXS ports for analog voice delivery, an integrated DSX-1 port for PBX connectivity, and a 10/100Base-T Ethernet interface for access to the 900/900e's router. The Total Access 900/900e Series can be coupled with a NetVanta® 1224ST Power over Ethernet (PoE) switch to provide connectivity to a variety of network devices and personal computers, as well as to power IP phones and wireless access points.

SIP Gateway

The Total Access 900/900e Series utilizes SIP for VoIP applications, providing interoperability with industry-leading softswitches, feature servers, and gateways. Acting as a SIP gateway, these devices convert SIP signaling from the carrier into traditional TDM analog and digital voice services. This functionality allows the Total Access 900/900e Series to deliver voice services to both IP phones and traditional telephony equipment simultaneously. For customers implementing a hosted PBX or IP Centrex service, the Total Access 900/900e Series is ideal for providing customers additional analog ports necessary to support their remaining analog phones, fax machines, or modems. The Total Access 900/900e Series supports many popular calling features such as caller ID, call hold, forward, transfer, and call waiting.

Remote Survivability

In addition, the Total Access 900/900e Series can act as a registrar and Back-to-Back User Agent (B2BUA) to facilitate remote survivability and Network Address Translation (NAT) traversal. In the event of a service interruption on the WAN or if the carrier's call agent were to become unavailable, calls may continue locally at the customer premise between IP-based or analog phones. Voice Activity Detection (VAD) and silence suppression are supported and the flexible design allows the Total Access 900/900e Series to support additional CODECs as the market requires.

QoS, Security, Routing

The Total Access 900/900e Series uses the AOS to provide a stateful inspection firewall, Network Address Translation (NAT), DHCP server/client, and feature-rich, standards-based, IP routing functionality supporting BGP, OSPF, and RIP routing protocols. Inherent Quality of Service (QoS) methods ensure appropriate classification and prioritization of VoIP traffic. These methods include Low Latency Weighted Fair Queuing, class based weighted fair queuing, support for Differentiated Services (DiffServ) protocol, Frame Relay Fragmentation (FRF.12), and Frame Relay traffic shaping.

Configuration

The Total Access 900/900e Series can be managed via a standard Command Line Interface (CLI), a web-based Graphical User Interface (GUI), or ADTRAN's n-Command® network management platform. The web-based GUI provides an intuitive step-by-step configuration wizard and the ability to upload firmware updates.

n-Command offers the ability to discover devices, make mass configuration changes or firmware upgrades, backup/restore configuration, globally modify Access Control Lists (ACLs), and generate inventory reports for asset management. These devices can be managed locally and remotely via SNMP, HTTP/HTTPS, Telnet, or SSH.

Total Access 900/900e products are housed in a rugged metal enclosure, are available in wallmount, rackmount, and desktop mountings, and offer battery backup system for up to eight hours of uninterrupted service upon a customer site power outage. Total Access 900/900e products are backed by an industry-leading 10-year warranty, free firmware updates, and ADTRAN's world-class technical support.





Total Access® 900/900e Series

VoIP Multiservice Access Gateway



Product Specifications

Physical Interfaces

WAN

- Single T1/FT1 (900 Series)
- Quad T1/FT1 (900e Series)
- RJ-48C

LAN

- Single auto-sensing 10/100Base-T (900 Series)
- Dual auto-sensing 10/100Base-T (900e Series)
- Full duplex
- RJ-45
- May also be used as the WAN interface

Digital Voice

- RJ-48C
- T1 CAS support (E&M Wink)
- PRI

Analog Voice

- 4, 8, 12, 16, and 24 FXS POTS via 50-pin amphenol
- 68.5 Vrms with 20VDC offset maximum ring voltage
- Sinusoidal ringer waveform
- 48 V, nominal on-hook battery voltage
- 24 mA, nominal loop current
- **FXS 2-wire impedances**
 - 600 Ω
 - 900 Ω
 - 600 Ω+2.16µF
 - 900 Ω+2.16µF
- **FXO 2-wire impedances**
 - 600 Ω+2.16µF
 - 900 Ω+2.16µF
- Integral FXO (900e IADs)

Craft

- DB-9

Processor and Memory

- RAM: 64 Mb RAM
- Flash: 16 Mb Flash

VoIP Protocol

- SIP

Packet-based Voice Resources

- CODECs
 - G.711-64k PCM
 - G.729a-8k CS-ACELP
- G.168 Echo Cancellation

- 16ms Echo-tail length
- Supports up to 24 channels (900 Series), 48 channels (900e Series)

Media Stream

- RTP/UDP/IP (RFC 3550)
- RTP payload for DTMF digits (RFC 2833)
- Supports port-to-port hairpin call
- SDP (RFC 2327)

NAT Traversal and Remote Survivability

- B2BUA
- SIP Registrar for IP phones

Tone Services

- **Local DTMF Detection**
- **Local Tone Generation**
 - Dialtone
 - Busy
 - Call Waiting
 - Alternate Call Waiting
 - Receiver Off Hook
- **Ringing**
 - Distinctive Ring

Calling Feature Support (varies with feature server/gateway)

- **Caller ID**
 - Name and Number
 - Name
 - Number
 - Call Waiting IAD
- **Voicemail**
 - Stutter dialtone
 - Visual Message Waiting Indicator (VMWI)
- **Call Hold**
- **Call Forward**
 - Busy Line
 - No Answer
- **Call Transfer**
 - Blind, Attended
- **Call Waiting**
- **Distinctive Ring**
- **Do Not Disturb**
- **Three-way Calling**
- **Call Return**
- **Speed Dial**



Total Access 908 (rear panel)



Total Access 916e (rear panel)

Security

Firewall

- Stateful Inspection Firewall
- Denial of Service (DOS) Protection
- Access Control Lists
- Application Level Gateways
- Packet Filtering

Network Address Translation

- Basic NAT (1:1) and NAT (Many:1)

Quality of Service (QoS)

- Low Latency and Weighted Fair Queuing (WFQ)
- DiffServ packet marking and recognition
- Frame Relay Fragmentation

Protocols

- BGP
- OSPF
- RIP (v1 and v2)
- GRE
- IGMP V2
- Frame Relay
- Multilink Frame Relay
- PPP
- Multilink PPP
- HDLC
- PAP and CHAP

Routed Protocols

- IP

DHCP

- Client
- Relay
- Server

Management and Utilities

- Familiar Command Line Interface (CLI)
- Web-based GUI
- n-Command™ support
- SNMP v2
- SYSLOG logging
- Telnet, Craft/Console Port, SSH, Ping, Trace route, NTP

Firmware Upgrade

- FTP
- X-Modem
- TFTP
- HTTP

Environment

- Operating Temperature: 0° to 50 °C (32° to 122 °F)
- Storage Temperature: -20° to 70 °C (-4° to 158 °F)
- Relative Humidity: Up to 95%, non-condensing

Physical and Power

- Chassis
 - Wallmount
 - 1U Rackmount
 - Desktop metal enclosure
- Dimensions: 1.72" H x 17.2" W x 8.5" D
- Weight: 5.5 lbs.
- Power: 120 VAC, 60 Hz AC Power Supply
- Battery Backup: Optional 8-hour system
- LEDs
 - Status
 - Power
 - Voice
 - Data
 - Net
 - DSX-1
 - Link
 - TD/RD

Agency Approvals

- FCC Part 68
- Industry Canada CS03
- ETL and Canadian ETL (C-ETL)
- FCC Part 15, class A

Warranty

- 10 years (North American)



Total Access Rackmount or Wallmount 117504L1



Total Access Wallmount 117504L2



ADTRAN, Inc.
Attn: Enterprise Networks
901 Explorer Boulevard
Huntsville, AL 35896

P.O. Box 14000
Huntsville, AL 35814-4000

256 963-8000 voice
256 963-8699 fax

General Information
800 9ADTRAN
info@adtran.com
www.adtran.com

**Pre-Sales
Technical Support**
800 615-1176 toll-free
application.engineer@adtran.com
www.adtran.com/support

Where to Buy
877 298-9416 toll-free
channel.sales@adtran.com
www.adtran.com/wheretobuy

**Post-Sales
Technical Support**
888 423-8726
support@adtran.com
www.adtran.com/support

**ACES Installation &
Maintenance Service**
888 874-ACES
aces@adtran.com
www.adtran.com/support

International Inquiries
256 963 8000 voice
256 963-8300 fax
international@adtran.com
www.adtran.com/international

For the regional office
nearest you, visit:
www.adtran.com/regional



ADTRAN is an ISO 9001, ISO 14001,
and a TL 9000 certified supplier.
04210912L1-80 October 2008
Copyright © 2008 ADTRAN, Inc.
All rights reserved.

Total Access[®] 900/900e Series

Carrier-Class VoIP Integrated Access Devices

Ordering Information

Equipment	Part #
Total Access 900/900e Series	
Total Access 904	4210904L1
Total Access 908	4210908L1
Total Access 908e	4240908L1
Total Access 912	4210912L1
Total Access 916	4210916L1
Total Access 916e	4240916L1
Total Access 924	4210924L1
Total Access 924e	4240924L1
Total Access 924, 16 FXS + 8 FXO	4210924L2
Total Access 924e, 16 FXS + 8 FXO	4240924L2
Total Access 912/916/924 19" Rackmount Bracket	1200927L19
Total Access 912/916/924 23" Rackmount Bracket	1200927L23
Battery Backup Systems	
8-hour, Wallmount/Rackmount Total Access 912/916/924	1175044L1
8-hour, Wallmount Total Access 912/916/924	1175044L2
Total Access IAD to Battery Backup (L1) Mounting Bracket	1200927L1
Total Access IAD to Wallmount Battery Backup (L2) Mounting Bracket	1200927L2
Total Access IAD to Battery Backup (L1) Mounting Bracket	1200927L1

Specifications subject to change without notice. ADTRAN, e-Connect, NetVista, and Total Access are registered trademarks of ADTRAN, Inc. All registered trademarks and trademarks mentioned in this publication are the property of their respective owners.

48-Device USB Charging Station Cabinet with Sync for iPad and Android Tablets, Wall-Mount and Cart Options, Black

MODEL NUMBER: CS48USB



Highlights

- Fast 2.4A USB charging, syncing and storage for 48 devices
- Locking steel cabinet with flow-through ventilation
- Adjustable device dividers and integrated cord management
- Ships fully assembled and mounts to wall, desk, table or floor
- Detachable 10 ft. power cord

Package Includes

- CS48USB 48-Device USB Charging Station Cabinet, Black
- Detachable 10 ft. AC input cord w/NEMA 5-15P plug
- (2) Keys
- Owner's manual

Description

The CS48USB 48-Device USB Charging Station Cabinet provides fast charging, convenient syncing, secure storage and cord management for up to 48 iPad, Android, Surface and Kindle tablets, as well as mobile phones and other USB devices. It's recommended for education, office, commercial, retail, industrial and healthcare environments.

48 USB ports deliver the fastest charging supported by each device, up to 2.4A per port. The charging station also supports wired and wireless syncing, including syncing while charging.

The steel cabinet promotes comprehensive device protection with steel construction and a black powder-coated finish for long-term durability. It locks with the included keys to help prevent device theft, damage or tampering. Flow-through ventilation protects against overheating, and the coated shelves help prevent scratches and scuffs. The charging station also provides clutter-free organization of devices and cabling.

The CS48USB is easy to configure. It ships fully assembled and supports mounting to a wall, desk, table, counter or floor. The front door opens 180 degrees for improved device and service access, and removable dividers accommodate thicker devices. You can convert the CS48USB to a mobile cart with Tripp Lite's optional CSHANDLEKIT accessory (sold separately).

Features

Fast Charging

- 48 USB ports provide fastest charging supported by each device, up to 2.4A per port
- Recommended for iPad®, Android™, Surface™ and Kindle™ tablets
- Also charges mobile phones and other USB devices
- Detachable 10 ft. AC input cord with NEMA 5-15P plug

Convenient Syncing

- USB sync uplink port connects to host computer for wired syncing



Tripp Lite
111 W. 35th Street
Chicago, IL 60609 USA
Telephone: 773.369.1234
www.trippite.com

- Compatible with wireless syncing
- Supports simultaneous syncing and charging (up to 1.5A per port during wired syncing)

Comprehensive Protection

- Sturdy steel construction and powder-coated finish promote long-term durability
- Doors lock with included keys to help prevent device theft, damage or tampering
- Flow-through ventilation helps prevent devices from overheating
- Coated shelves shield devices from scratches and scuffs

Flexible Configuration

- Ships fully assembled
- Supports mounting to wall, desk, table, counter or floor
- Door opens 180 degrees for improved device and service access
- Removable dividers accommodate thicker devices
- Firmware upgrade port for future updates
- Converts to mobile cart with optional [CSHANDLEKIT](#) accessory (sold separately)

Specifications

OUTPUT	
Charging Ports / Amps	(48) 2.4A
Charging Method	USB
INPUT	
Input Connection Type	C14 Inlet with 100-250V AC compatibility. Also accepts user-supplied country-specific AC cordsets
Voltage Compatibility (VAC)	100-250
Input Frequency	50 / 60 Hz (auto-select)
PHYSICAL	
Shipping Dimensions (hwd / in.)	41 x 28.4 x 26.4
Shipping Dimensions (hwd / cm)	104.1 x 72.1 x 67.1
Shipping Weight (lbs.)	183
Shipping Weight (kg)	82.4
Unit Dimensions (hwd / in.)	35.6 x 23.62 x 21.6
Unit Dimensions (hwd / cm)	90.42 x 59.9 x 54.86
Unit Weight (lbs.)	150
Unit Weight (kg)	68.04
Color	Black
Slot Dimensions - Top (hwd / in.)	8.1 x 0.8 x 13.9

2 / 3



Tripp Lite
111 W. 35th Street
Chicago, IL 60609 USA
Telephone: 773.369.1234
www.tripplite.com

Slot Dimensions - Top (hwd / mm)	206 x 20.1 x 353.8
Slot Dimensions - Bottom (hwd / in.)	8.0 x 0.8 x 13.9
Slot Dimensions - Bottom (hwd / mm)	204 x 20.1 x 353.8
Slot Dimensions - Middle (hwd / in.)	8.0 x 0.8 x 13.9
Slot Dimensions - Middle (hwd / mm)	204 x 20.1 x 353.8
CERTIFICATIONS	
Certifications	Tested to EIA-310-E, UL60950, FCC & IEC Class B
NOM (Mexico)	Tested to NOM (Mexico)
Approvals	RoHS
WARRANTY	
Product Warranty Period (Worldwide)	2-year limited warranty

© 2017 Tripp Lite. All rights reserved. All product and company names are trademarks or registered trademarks of their respective holders. Use of them does not imply any affiliation with or endorsement by them. Tripp Lite has a policy of continuous improvement. Specifications are subject to change without notice. Tripp Lite uses primary and third-party agencies to test its products for compliance with standards. See a list of Tripp Lite's testing agencies: <http://www.tripplite.com/products/product-certification-agencies>

ZoneFlex R310

Entry Level 802.11ac 2x2:2 Access Points



DATA SHEET



ENTRY LEVEL 802.11AC 2X2:2 ACCESS POINT WITH ADAPTIVE ANTENNA TECHNOLOGY

The Ruckus ZoneFlex R310 delivers reliable 802.11ac wireless networking at the industry's most affordable price point.

Unlike any other 802.11ac wireless solution in its class, the ZoneFlex R310 combines patented adaptive antenna technology and automatic interference mitigation to deliver consistent, predictable performance at extended ranges with up to 4dB of statistical BeamFlex gain and up to 10dB of interference mitigation.

Additional performance enhancements to signal gain can be attributed to the chip-based transmit beamforming capability adding 3dB when associated to a compatible client.

Each ZoneFlex R310 integrates Ruckus-patented BeamFlex, a software-controlled, high gain antenna array that continually forms and directs each 802.11ac packet over the best performing signal path. The ZoneFlex R310 automatically selects channels for highest throughput potential using Ruckus ChannelFly dynamic channel

BENEFITS

INDUSTRY'S LOWEST COST ENTERPRISE CLASS 802.11AC SOLUTION

Unprecedented performance with extended range at the industry's most affordable price point

EXTENDED RANGE REQUIRES FEWER APs

Adaptive antenna technology delivers a 2x to 4x increase in Wi-Fi signal coverage minimizing the number of APs required to service any area

SLEEK, LOW PROFILE ENCLOSURE FOR EASE-OF-DEPLOYMENT

Aesthetically-pleasing design fits almost anywhere. Powerful 802.11ac technology that literally fits in the palm of your hand for easy deployment

CHANNEL SELECTION OPTIMIZES THROUGHPUT

ChannelFly dynamically chooses the best channel giving users the highest possible throughput even in highly congested environments

INTUITIVE CONFIGURATION AND MANAGEMENT

The industry's simplest configuration and management through a Web-based wizard and automated deployment capabilities

HASSLE FREE MIGRATION TO HIGHER SPEED WI-FI

Support for standard 802.3af power over Ethernet allows enterprises to use existing PoE switches without costly upgrades

PATENTED BEAMFLEX™ TECHNOLOGY EXTENDS SIGNAL RANGE, IMPROVES STABILITY OF CLIENT CONNECTIONS

All ZoneFlex R310 Smart Wi-Fi access points integrate a software-controlled smart antenna array that delivers up to an additional 4 dB of BeamFlex gain and 10 dB of Interference mitigation. This allows a 2 to 4x improvement in signal range and a reduction in packet loss from the ability to automatically mitigate interference and avoid obstacles.

ADVANCED WLAN APPLICATIONS

When used with the Ruckus ZoneDirector Smart WLAN controller, each ZoneFlex R310 supports a wide range of value-added applications such as guest networking, Dynamic PSK, hotspot authentication, wireless intrusion detection and many more. WLANs can be created and mapped to the same or different APs or VLANs. In a centrally managed configuration, the ZoneFlex R310 works with a wide range of authentication servers including Microsoft's Active Directory, LDAP, and RADIUS.

FLEXIBLE DEPLOYMENT OPTIONS

ZoneFlex R310 APs can be deployed as a standalone AP or as part of a centrally managed wireless LAN using ZoneDirector and SmartZone controllers. ZoneFlex R310 can be deployed across any L2/L3 network and can bridge traffic onto the local network, tunnel to a central location using L2TP or route between the WAN and NATed private subnets. When used with the controller, each ZoneFlex R310 is automatically configured through the network making deployment quick and easy.

COMPLETE LOCAL AND REMOTE MANAGEMENT

Each ZoneFlex R310 can be managed as a standalone AP through a Web-based GUI, using SNMP or through the Ruckus FlexMaster Wi-Fi remote management system. Local management can also be performed using the ZoneDirector or SmartZone controller. FlexMaster is a LINUX-based software platform that uses industry-standard protocols to perform bulk configuration, fault detection, monitoring and a wide range of troubleshooting capabilities over a wire area connection. The controllers enable local management and control of APs, adding value-added services such as transmit power control, and guest networking.

FEATURES

- Blazing fast 802.11ac speeds at the lowest cost in its class
- Dual-band concurrent (2.4GHz/5GHz) 802.11ac
- Adaptive antenna technology and advanced RF management
- Up to an additional 4dB BeamFlex gain / 10dB Interference mitigation
- Automatic Interference mitigation, optimized for high-density environments
- Integrated smart antenna technology
- Standard 802.3af Power over Ethernet (PoE)
- Router mode with NAT and DHCP services
- 2 to 4 times extended range and coverage
- IP multicast video streaming support
- Up to 8 BSSIDs per radio (16 BSSIDs per access point) with unique QoS and security policies
- Advanced QoS packet classification and automatic priority for latency-sensitive traffic
- Dynamic, per-user rate-limiting for hotspot WLANs
- WPA-PSK (AES), 802.1X support for RADIUS and Active Directory**
- Ethernet 802.1X port-based authentication (authenticator and supplicant)
- Zero-IT and Dynamic PSK**
- Admission control/load balancing**
- Bandsteering and airtime fairness
- Captive portal and guest accounts **
- Guest access services**
- Application Recognition and Control**
- Wall, desktop or ceiling mountable
- Limited lifetime warranty

** when used with Ruckus ZoneDirector or SmartZone controllers.

SMALL LIGHTWEIGHT FORM FACTOR WITH BUILT IN MOUNTING OPTIONS FOR EASY DEPLOYMENT

The ZoneFlex R310 installs & mounts seamlessly, making it ideal for quick and effective set up for carrier & enterprise deployments.

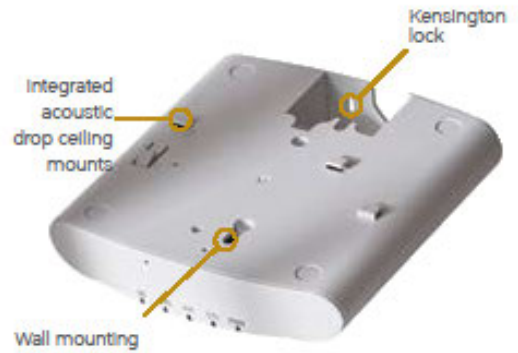

220 g (0.485 lbs)

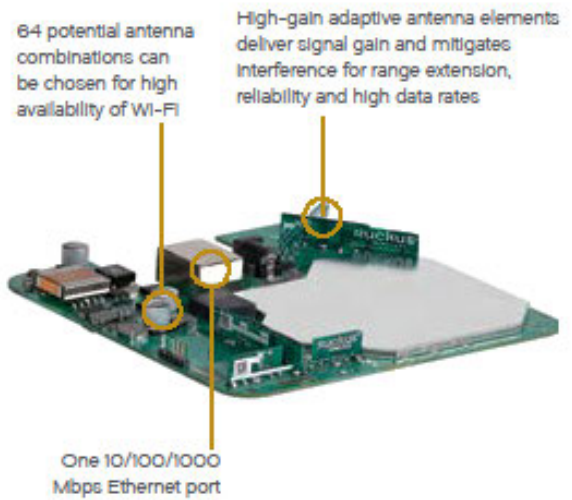
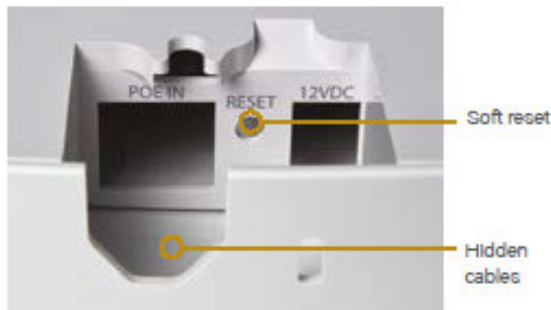

ZoneFlex R310

Entry Level 802.11ac 2x2:2 Access Points

DATA SHEET

PHYSICAL CHARACTERISTICS	
Power	<ul style="list-style-type: none"> DC Input: 12 VDC 10A Power over Ethernet: 802.3 af
Physical Size	<ul style="list-style-type: none"> 13.8cm (L), 13.5cm (W), 3.3cm (H) 5.4 in (L), 5.3 in (W), 1.3 in (H)
Weight	<ul style="list-style-type: none"> 220 grms (0.485 lbs)
Ethernet Ports	<ul style="list-style-type: none"> 1 auto MDX, auto-sensing 10/100/1000Mbps, RJ-45, PoE port
Lock Options	<ul style="list-style-type: none"> Hidden latching mechanism Kensington Lock Hole T-bar Torx
Environmental Conditions	<ul style="list-style-type: none"> Operating Temperature: 0°C - 40°C Operating Humidity: 10% - 95% non-condensing
Power Draw	<ul style="list-style-type: none"> DC Input Idle: 6W Typical: 7W Peak: 9W Power over Ethernet Input Idle: 6W Typical: 7.8W Peak: 9W

PERFORMANCE AND CAPACITY	
Max Phy Rate	<ul style="list-style-type: none"> 300 Mbps (2.4GHz) 867 Mbps (5GHz)
Concurrent Stations	<ul style="list-style-type: none"> 100 clients per AP
Simultaneous VoIP Clients	<ul style="list-style-type: none"> 30

RF	
ANTENNA	<ul style="list-style-type: none"> Adaptive antenna that provides up to 128 unique antenna patterns 64 patterns per band
RF POWER OUTPUT (Aggregated)	<ul style="list-style-type: none"> 23dBm for 2.4GHz* 24dBm for 5GHz*
PHYSICAL ANTENNA GAIN	<ul style="list-style-type: none"> Up to 3dBi per spatial stream
BEAMFLEX™ SINR TX GAIN	<ul style="list-style-type: none"> Up to 4dB
INTERFERENCE MITIGATION	<ul style="list-style-type: none"> Up to 10dB
MINIMUM RX SENSITIVITY	<ul style="list-style-type: none"> Up to -99dBm

*BeamFlex gains are statistical system level effects translated to enhanced SINR based on observations over time in real-world conditions with multiple APs and many clients

MANAGEMENT	
Deployment Options	<ul style="list-style-type: none"> Standalone (individually managed) Managed by ZoneDirector* Managed by FlexMaster* Managed by SmartZone
Configuration	<ul style="list-style-type: none"> Web User Interface (HTTP/S) CLI (Telnet/SSH), SNMP v1, 2, 3 TR-069 via FlexMaster
Auto Ap Software Updates	<ul style="list-style-type: none"> FTP or TFTP, remote auto available

*NOTE: SPECIFICATIONS ARE SUBJECT TO CHANGE WITHOUT NOTICE
*some features not supported - e.g., mesh

Wi-Fi	
Standards	<ul style="list-style-type: none"> IEEE 802.11a/b/g/n/ac 2.4GHz and 5GHz
Supported Data Rates	<ul style="list-style-type: none"> 802.11n/ac: 6.5Mbps - 73.4Mbps (20MHz) 13.5Mbps - 400Mbps (40MHz), 293Mbps - 867Mbps (80MHz) 802.11a: 54, 48, 36, 24, 18, 12, 9 and 6Mbps 802.11b: 1, 5.5, 2 and 1 Mbps 802.11g: 54, 48, 36, 24, 18, 12, 9 and 6 Mbps
Radio Chains	<ul style="list-style-type: none"> 2 x 2
Spatial Streams	<ul style="list-style-type: none"> 2
Channelization	<ul style="list-style-type: none"> 20MHz, 40MHz, 80MHz
Operating Channels	<ul style="list-style-type: none"> US/Canada: 1-11, Europe (ETSI): X30: 1-13, Japan X4: 1-13 5 GHz channels: Country dependent
Frequency Band	<ul style="list-style-type: none"> IEEE 802.11 b/g/n: 2.4 - 2.484 GHz IEEE 802.11a/ac: 5.15 - 5.25 GHz; 5.25 - 5.35 GHz; 5.47 - 5.725 GHz; 5.725 - 5.85 GHz
Bssid	<ul style="list-style-type: none"> Up to 8 per radio (8 per AP)
POWER SAVE	<ul style="list-style-type: none"> Supported
Wireless Security	<ul style="list-style-type: none"> WPA-PSK, WPA-TKIP, WPA2, AES, 802.1i Authentication via 802.1X with the ZoneDirector or SmartZone, local authentication database, support for RADIUS, LDAP, and ActiveDirectory
Certifications**	<ul style="list-style-type: none"> U.S., Europe, Argentina, Australia, Brazil, Canada, Chile, China, Colombia, Costa Rica, Ecuador, Egypt, Hong Kong, India, Indonesia, Israel, Japan, Jordan, Kenya, Korea, Malaysia, Mexico, New Zealand, Peru, Philippines, Russia, Saudi Arabia, Singapore, South Africa, Taiwan, Thailand, UAE, Vietnam WEEE/RoHS2 compliance EN 60601-1-2 (Medical) Wi-Fi Alliance Industry Canada EU/CEFTA CB Scheme Certificate EN 50121-1 Railway EMC EN 50121-4 Railway Immunity IEC 61373 Railway Shock & Vibration UL 2043 Plenum Rated

* Maximum power varies by country
** For current certification status please see price list

PRODUCT ORDERING INFORMATION

MODEL	DESCRIPTION
ZoneFlex R310 Smart Wi-Fi 802.11ac Access Point	
901-R310-XX02	Concurrent dual band 802.11ac AP, no power adapter
Optional Accessories	
902-0120-0000	Universal secure mounting bracket fits multiple ZoneFlex AP's including R310. Mounts to Hard Wall, Ceiling, Pole & Truss. Fits without pad-lock support.
902-0173-XX10	Power Adapter, AC/DC wall plug 100-250Vac 50/60Hz
902-0162-XXYY	PoE Adapter

PLEASE NOTE: When ordering ZoneFlex Indoor AP's, you must specify the destination region by indicating -US, -WW, or -Z2 instead of XX. When ordering PoE injectors or power supplies, you must specify the destination region by indicating -US, -EU, -AU, -BR, -CN, -IN, -JP, -KR, -SA, -UK, or -UN instead of -XX.

For access points, -Z2 applies to the following countries: Algeria, Egypt, Israel, Morocco, Tunisia, and Vietnam

Warranty: Sold with a limited lifetime warranty
For details see <http://support.ruckuswireless.com/warranty>

Copyright © 2016, Ruckus Wireless, Inc. All rights reserved. Ruckus Wireless and Ruckus Wireless design are registered in the U.S. Patent and Trademark Office. Ruckus Wireless, the Ruckus Wireless logo, BeamFlex, ZoneFlex, MediaFlex, FlexMaster, ZoneDirector, SpeedFlex, SmartCast, SmartCell, ChannelFly and Dynamic PSK are trademarks of Ruckus Wireless, Inc. in the United States and other countries. All other trademarks mentioned in this document or website are the property of their respective owners.
16-08-B

Ruckus Wireless, Inc. | 350 West Java Drive | Sunnyvale, CA 94089 USA | T: (650) 265-4200 | F: (408) 738-2065
ruckuswireless.com





The Eaton 3S — Sleek. Savvy. Sophisticated.

The sleek Eaton® 3S delivers high efficiency and energy-saving battery backup and surge protection for your premium home and office equipment — ready to go right out of the box.

Eaton 3S features and benefits:

Ease-of-use: The plug-and-play functionality of the 3S allows you to start backing up your equipment the moment you take the unit out of the box (3S550 & 750 only). Gain automatic integration with Windows, Mac and Linux with a simple connection to a USB port.

EcoControl: The 3S manages your energy efficiency for you with EcoControl Master/Control outlets (model 3S750 only). When the item using the Master outlet (e.g., your computer) is idle or shut down, then items using the Control outlets (e.g., printer, scanner, fax) are automatically powered down — rewarding you with up to 30% in energy savings over a typical battery backup.

Modern design: The sleek design of the 3S allows you to display it alongside your high-tech equipment for a sophisticated look. This unit can also be wall- or desk-mounted for additional space savings.

Premium protection: The high-efficiency design of the Eaton 3S provides premium power protection for up to 10 devices, including those using data lines.

Intelligent Power Protector

By combining Eaton's Intelligent Power® Protector software with the 3S, you can monitor and manage all of the power devices on your network. You can even enable graceful shutdown of computers during an extended power outage.

To learn more, please visit:

Eaton.com/intelligentpower

Services and support

Eaton provides product support 24 hours a day, 7 days a week. From battery replacement to full service plans, Eaton is one of the top service models in the industry.

Three-year warranty

The 3S warranty covers both the UPS and the batteries for three years. No other manufacturer in the industry offers as comprehensive a warranty.

Battery runtime

The 3S provides up to 45 minutes of battery backup. For a detailed interactive battery runtime chart, please visit: Eaton.com/3S — then view the individual technical specifications pages for details of each unit.



The compact, versatile 3S fits under a desk or mounts on the wall.



3S MODEL SELECTION GUIDE*

Catalog Number	Power rating (VA/Watts)	Input connection	Output receptacles***	Dimensions (H x W x D), in	Net weight, lb
120V, 50/60 Hz					
3S350	350/200	5-15P	(8) 5-15R	3.4 x 5.5 x 13.2	6.6
3S550	550/330	5-15P	(8) 5-15R	3.4 x 5.5 x 13.2	7.3
3S750**	750/450	5-15P	(10) 5-15R	3.4 x 6.7 x 13.2	9.7

* Due to continuous product improvement programs, all specifications are subject to change without notice. Please visit Eaton.com/3S to view complete product specifications.

** This model has EcoControl energy savings capability. To enable EcoControl, download Eaton's Personal Solution-Pac software: Eaton.com/psp.

*** On each unit, half of the receptacles provide battery backup and surge protection, half provide surge protection only.

Eaton 3S (750 VA)

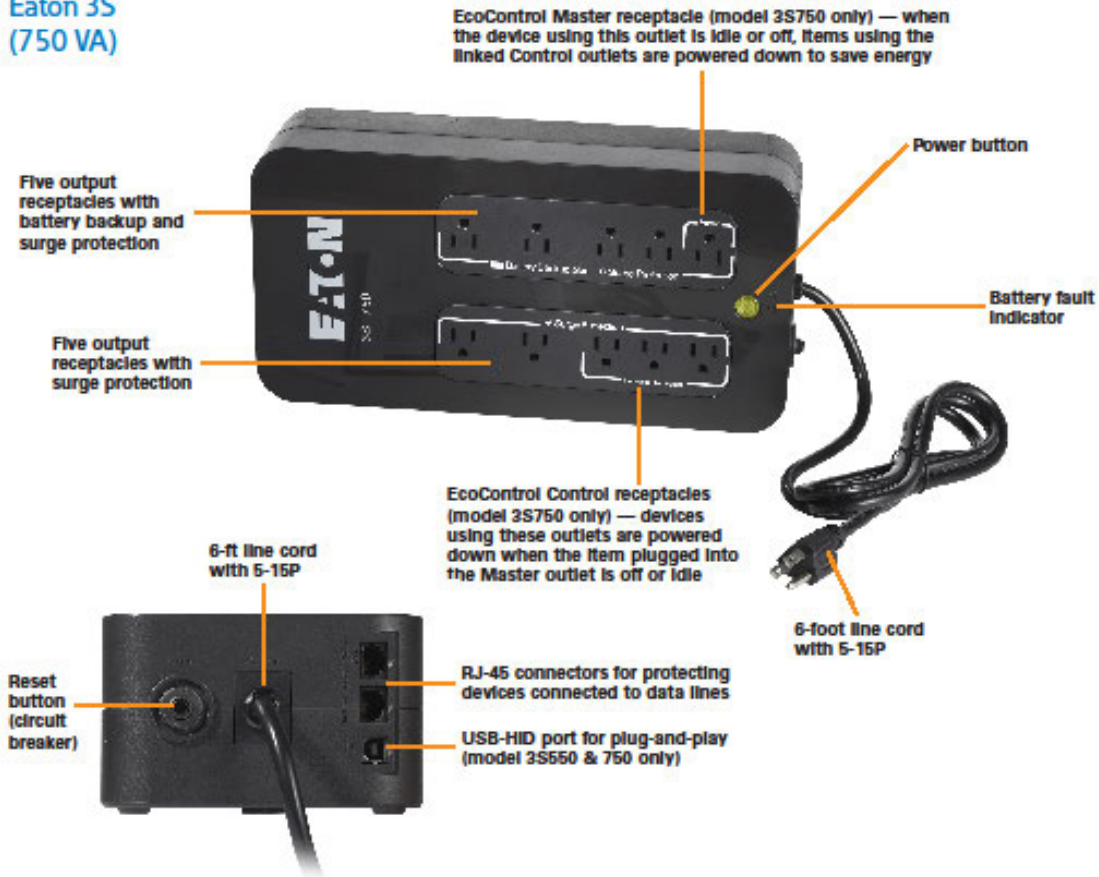

To interact with the 3S, please visit:
Eaton.com/3S



Eaton Corporation
Electrical Sector
1111 Superior Avenue
Cleveland, OH 44114 USA
Eaton.com

8809 Six Forks Road
Raleigh, NC 27615 U.S.A.
Toll Free: 1.800.356.5794

CANADA
Ontario: 416.796.0112
Toll free: 1.800.461.9166

powerquality.eaton.com

©2011 Eaton Corporation
All Rights Reserved
Printed in USA
3501FXA
July 2012

Eaton and Intelligent Power are trademarks of Eaton Corporation.

All other trademarks are property of their respective owners.



OptiPlex 3040



Essential business-class computing

OptiPlex 3040 simplifies business computing with best-in-class security and manageability in new, smaller energy-efficient designs—Mini Tower, Small Form Factor and Micro Form Factor.

Available with up to 6th Gen Intel® Core™ i5 Processors, Intel® Integrated graphics, and Dell Client Command Suite tools for time-saving systems management, OptiPlex 3040 provides excellent value at an entry-level price.

Enhance these features with purpose-built Dell accessories such as award winning monitors, custom-designed cable covers, and a variety of Micro mounts for a complete computing experience; all backed by outstanding 24x7 ProSupport Plus.

For more information visit:
www.dell.com

Feature	3040 MT/SFF/Micro Technical Specifications			
Processors ¹	Intel® 6th generation Core™ i5 Quad Core (65W for MT & SFF, 35W for micro), Core™ i3 Dual Core, Pentium® Dual Core and Celeron® Dual Core (65W for MT & SFF, 35W for Micro)			
Chipset	Intel® H110 Chipset			
Operating System	Microsoft® Windows 10 Home 64-bit, Microsoft® Windows 10 Pro 64-bit Microsoft® Windows 8.1 Standard 64-bit, Microsoft® Windows 8.1 Pro 64-bit Microsoft® Windows 7® Professional SP1 (32/64 bit) Ubuntu® Neokylin® (China only)			
Graphics Options ²	Integrated Intel® HD Graphics 530 Supports optional discrete graphics (MT/SFF only): AMD Radeon™ R7 350X, AMD Radeon™ R5 340X			
Memory ²	2 Long DIMM slots; Non-ECC dual-channel 1600MHz DDR3L SDRAM, supports up to 16GB (MT/SFF); 2 SO-DIMM slots (MFF)			
Networking	MT/SFF: Integrated Realtek® RTL8111HSD Ethernet LAN 10/100/1000; Optional wireless: 802.11ac+ Bluetooth 4.1 card Micro: Integrated Realtek® RTL8111HSD Ethernet LAN 10/100/1000; Optional wireless M.2 802.11ac + Bluetooth 4.1 card			
I/O Ports	MT/SFF: 8 External USB: 4 x 3.0 (2 front/2 rear) and 4 x 2.0 (2 front/2 rear); 1 RJ-45; 1 Serial (optional); 1 Display Port 1.2; 1 HDMI 1.4; 2 PS/2 (optional); 1 UAJ, 1 Line-out; 1 VGA (optional) MFF: 6 External USB: 4 x 3.0 (2 front/2 rear) and 2 x 2.0 (2 rear); 1 RJ-45; 1 HDMI 1.4; 1 Display Port 1.2; 1 UAJ (front); 1 Line-out (front); 1 Serial (optional); 1 VGA (optional); Serial+PS2 (optional)			
Removable Media Options	Supports optional optical disc drives and media card reader (MT/SFF only)			
Hard Drive ⁴ Options (internal)	Hard Disk Drives: up to 1TB Supports Solid State Drives, Hybrid and Hybrid Opal SED FIPS No Hard Drive – Supports Dell Cloud Desktop diskless			
Chassis		Minitower (MT)	Small Form Factor (SFF)	Micro (MFF)
	Dimensions (H x W x D) Inches/(cm)	13.8 x 6.1 x 10.8 (inches) 35 x 15.4 x 27.4 (cm)	11.4 x 3.6 x 11.5 (inches) 29 x 9.2 x 29.2 (cm)	7.2 x 1.4 x 7 (inches) 18.2 x 3.6 x 17.8 (cm)
	Weights (lbs./kg)	17.49 / 7.93	13.45 / 6.1	2.82 / 1.28
	Number of Bays	1 internal 3.5" 2 internal 2.5" 1 external 5.25"	1 internal 3.5" 1 internal 2.5"	1 internal 2.5"
	Expansion Slots	1 full height PCIe x16 3 full height PCIe x1	1 half height PCIe x16 1 half height PCIe x1	1 M.2 (22x30mm) (Wireless only)
	Power Supply ⁶ Unit (PSU)	Standard 240W PSU Active PFC ³ 240W up to 85% Efficient PSU (80 PLUS Bronze) ENERGY STAR compliant, Active PFC 240W up to 92% Efficient PSU (80 PLUS Platinum); ENERGY STAR compliant, Active PFC	Standard 180W PSU Active PFC 180W typical 85% Efficient PSU (80 PLUS Bronze) ENERGY STAR compliant, Active PFC 180W typical 92% Efficient PSU (80 PLUS Platinum); ENERGY STAR compliant, Active PFC	65W external adapter, 87% minimum average efficiency
Recommended Accessories	Monitors - qualified with Dell commercial monitors including Dell E series monitor 17" – 27", Touch monitor in 20" screen size Dell Professional series monitors available from 19"-27", Touch monitor in 23" screen size			
	Micro Mounting Options: Vertical Stand, VESA Mount, Dual VESA Mount, All in One Mount, Console with DVD-RW, All in One Mount for E Series Displays			
	Keyboards: Dell wired Keyboard with Multimedia functionality, Dell Smart Card Keyboard, Dell Wireless KB/Mouse, Logitech Wireless KB/Mouse			
	Mouse: Dell wired Mouse, Dell wireless mouse, Dell Laser Mouse.			
Security Options	Audio Speakers: Internal Dell Business audio speaker, Dell stereo speaker systems available; Dell sound bar for select Flat-panel displays. Dell Wireless Speaker System available.			
	Trusted Platform Module ³⁰ (TPM) 2.0 Dell Data Protection Security Tools, Dell Data Protection Encryption, Chassis lock slot support, Chassis Intrusion Switch, Setup/BIOS Password, I/O Interface Security, optional Smart Card keyboards, Intel® Trusted Execution Technology, Intel® Identity Protection Technology, Intel® Anti-Theft Technology, KACE Security, Dell Secure Works, BIOS support for optional Computrace ⁹			
Systems Management Options	Dell Client Command Suite; In-Band Systems Management			

Feature	3040 MT/SFF/Micro Technical Specifications
Environmental, Ergonomic, & Regulatory Standards	Environmental Standards (eco-labels): ENERGY STAR 6.0, EPEAT Registered ⁶ , CECP, WEEE, Japan Energy Law, South Korea E-standby, South Korea Eco-label (for SFF only), EU, RoHS, China RoHS Other Environmental Options: Carbon Off-set; Asset Resale and Recovery Service. TAA configurations available.
Warranty	Limited Hardware Warranty ⁷ ; Standard 3-year On Site Service after Remote Diagnosis ⁸ (3-3-3); Optional 3 year Dell ProSupport offers premium support from expert technicians and 24x7 availability ⁹ .
Configuration Services	Factory image load, BIOS customization, hardware customization, asset tagging, reporting

Discover professional class desktops at Dell.com/OptiPlex

¹ Offering may vary by region. Some items may be available post-RTS. Offering may vary by region and configuration. For complete details, refer to the Technical Guidebook published on www.dell.com.

² System Memory and Graphics: Significant system memory may be used to support graphics, depending on system memory size and other factors.

³ 4GB or Greater System Memory Capability: A 64-bit operating system is required to support 4GB or more of system memory. Optional DDR4 memory support will be available in select regions, launch expected in the July-Aug 2016 time frame.

⁴ Hard Drive: GB means 1 billion bytes and TB equals 1 trillion bytes; actual capacity varies with preloaded material and operating environment and will be less.

⁵ Computrace: Not a Dell offer. Certain conditions apply. For full details, see terms and conditions at www.lockforlaptops.com.

⁶ Please refer to www.epeat.net for specific country registration rules and participation.

⁷ Limited Hardware Warranty: For copy of Ltd Hardware Warranty, write Dell USA LP, Attn: Warranties, One Dell Way, Round Rock, TX 78682 or see www.dell.com/warranty.

⁸ Onsite Service after Remote Diagnosis: Remote Diagnosis is determination by online/phone technician of cause of issue; may involve customer access to inside of system and multiple or extended sessions. If issue is covered by Limited Hardware Warranty (www.dell.com/warranty) and not resolved remotely, Technician and/or part will be dispatched, usually within 1 business day following completion of Remote Diagnosis. Availability varies. Other conditions apply.

⁹ Dell Services: Availability and terms of Dell Services vary by region. For more information, visit www.dell.com/servicesdescription.

¹⁰ TPM: TPM is not available in all regions.

¹¹ PSU: This form factor utilizes a more efficient Active Power Factor Correction (APFC) power supply. Dell recommends only Universal Power Supplies (UPS) based on Sine Wave output for APFC PSUs, not an approximation of a Sine Wave, Square Wave, or quasi-Square Wave (see UPS technical specifications). If you have questions please contact the manufacturer to confirm the output type.

Datasheet

HP ENVY 4520 All-in-One Printer



Do more with an affordable HP ENVY all-in-one—the perfect match for your technology. Save up to 50% on ink* with HP Instant Ink, and enjoy the easiest way to print from your smartphone or tablet. Get wireless printing and lab-quality photos.



ISO speeds: Up to 9.5 ppm black; Up to 6.8 ppm color
Scan resolution: Up to 1200 x 2400 ppi hardware; Up to 1200 dpi optical
Copy resolution: 600 x 300 dpi black (text and graphics); 600 x 300 dpi color (text and graphics)
Standard connectivity: 1 Hi-Speed USB 2.0; 1 Wi-Fi 802.11n
Paper handling: Up to 100 sheets input tray; 25-sheet output tray
Duty cycle: Up to 1,000 pages



You can afford to be creative with HP Instant Ink

- Save up to 50% on ink* and never run out. Print lab-quality photos at home for pennies.
- Full of value. Print up to twice as many pages or photos with Original HP high-yield ink cartridges.¹
- Get high-quality prints—time after time—with an all-in-one designed and built to be reliable.

Easy photo printing from your mobile device

- Your device, your choice. Easily print documents and photos from a variety of smartphones and tablets.²
- Start printing and get connected quickly with easy setup from your smartphone, tablet, or PC.³
- Connect your smartphone or tablet directly to your printer—and easily print without accessing a network.⁴
- Manage printing tasks and scan on the go with the free HP All-in-One Printer Remote mobile app.⁵

Everything you need to create

- Print, scan, or copy quickly and easily with the 2.2-inch (5.5 cm) display—simply touch and go.
- Save paper and conserve resources—use up to 50% less paper with easy, automatic two-sided printing.
- Print borderless, lab-quality photos, laser-quality documents, scrapbook pages, and more—right in your home.
- Print remotely without worries. The auto-deploying output tray keeps your pages from landing on the floor.

Do more in less space

- Save your space with a sleek, compact all-in-one designed to fit where you need it.
- Print in any room you choose—without causing disruptions—using the optional quiet mode.
- Access menu planners, news reports, recipes, and more with free HP Printables—delivered on your schedule.⁶

¹ In comparison to the majority of consumer/home office inkjet all-in-one printers. *\$399 USD as of Nov 2014 based on market share as reported by IDC. App download required for printer setup. HP ePrint account registration may be required. Wireless operations are compatible with 2.4 GHz operations only. See hp.com/go/mobileprinting for more details. ² Savings claim is based on HP Instant Ink Service plan price for 12 months using all pages in plan without purchase of additional pages compared to the cost per page (CPP) of the majority of color inkjet printers. *\$399 USD, market share reported by IDC Q2 2014. CPP comparison for standard-capacity inkjet supplies are based on estimated street price and page yield as reported by gpi.intelligence.com HP Weekly and IP Weekly Reports 9/20/2014. Actual savings may vary depending on number of pages actually printed per month and content of pages printed. ³ Based on internet connection to an eligible HP printer, valid credit/debit card, email address, and delivery service in your geographic area. ⁴ Based on plan usage, internet connection to an eligible HP printer, valid credit/debit card, email address, and delivery service in your geographic area. Enrollment in HP Instant Ink plan required. No annual fee. Cancel anytime. ⁵ Based on HP E94, High Yield Black and Tri-color Original Ink Cartridges. High-yield ink cartridges not included; purchase separately. For more information, see hp.com/go/learnaboutsupplies. Less cost per page compared with estimated street price and published page yield of standard-yield HP E3 Original Ink Cartridges. Actual pricing may vary. ⁶ Requires HP All-in-One Printer Remote mobile app download and is compatible with iPhone® 4 and later, iPad® fourth generation, iPad mini™, iPad Air®, iPod®, and mobile devices using Android™ 4.0.3 or later. For a full list of supported operating systems, see hp.com/go/mobileprinting. ⁷ Mobile device needs to be connected directly to the Wi-Fi Direct signal of a Wi-Fi Direct-supported M0 or printer prior to printing. Depending on mobile device, a free app or driver may also be required. For details, see hp.com/go/mobileprinting. ⁸ Compatible with iPhone® 4 and later, iPad® fourth generation, iPad mini™, iPad Air®, iPod® 5G using iOS 7 or later, and mobile devices using Android™ 4.0.3 or later. Features controlled may vary by mobile device operating system. For mobile scanning, device camera requires 5 megapixels or greater with autofocus capability. ⁹ Requires a wireless access point and an internet connection to the printer. Services require registration. HP Printables availability varies by country, language, and agreements and may require a firmware upgrade. Not all HP Printables can be set up for automatic delivery or for all printer models. For details, visit hp.com/go/hpconnect@hp/printables.

HP ENVY 4520 All-in-One Printer Specifications Table

Functions / Multitasking Supported	Print, copy, scan, photo/No
Print Speed¹	Black (ISO): Up to 9.5 ppm; Color (ISO): Up to 6.0 ppm Black (Draft): Up to 20 ppm; Color (Draft): Up to 16 ppm
Print Resolution	Black (Best): Up to 1200 x 1200 rendered dpi (when printing from a computer); Color (Best): Up to 4800 x 1200 optimized dpi color (when printing from a computer on selected HP photo papers and 1200 input dpi)
Print Technology	HP Thermal Inkjet
Print Cartridges Number	2 (1 black, 1 Tri-color [cyan, magenta, yellow])
Borderless Printing	Yes (up to 8.5 x 11 in, 216 x 297 mm)
Standard Print Languages	HP PCL 3 GLJ
Scan Type / Technology	Flatbed / GS
Scan Resolution	Hardware: Up to 1200 x 2400 ppi; Optical: Up to 1200 dpi
Scan File Format	TIF, JPEG, PNG, BMP, PDF
Scan Input Modes	Front-panel scan, Front-panel copy, HP Scan software
Scan Size Maximum	ADF: Does Not Apply; Flatbed: 8.5 x 11.69 in
Scan Speed	4 ppm color 8 ppm mono
Bit Depth / Grayscale Levels	24-bit/256
Digital Sending Standard Features	Scan to file (PDF or JPG), Scan to email (PDF or JPG) and Everyday Scan (which is scan to PDF)
Copy Speed	Black (ISO): Up to 7.5 cpm; Color (ISO): Up to 4 cpm
Copy Resolution	Black (text and graphics): 600 x 300 dpi; 600 x 300 dpi; Color (text and graphics): 600 x 300 dpi
Maximum Number Of Copies	50
Copier Ratio	25 to 400%
Copier Settings	Start Black, Copy Start Color Copy, Number of Copies, 2-sided, Paper Type, Resize, ID Card Copy, Lighter/Darker
Standard Connectivity	1 Hi-Speed USB 2.0; 1 Wi-Fi 802.11n
Network Ready	Standard (built-in Wi-Fi 802.11n/g/n)
Wireless Capability	Yes
Mobile Printing Capability²	Features wireless direct and local Wi-Fi connectivity to enable mobile printing via HP ePrint, Apple AirPrint™ as well as other solutions; MopriE-certified. Supports printing from most smartphones and tablets using these operating systems: Android, iOS, BlackBerry, Symbian, Windows 8, Windows RT and Windows 10 Mobile.
Memory	Standard: 64 MB DDR1 Memory; Maximum: 64 MB DDR1 Memory
Processor Speed	360 MHz
Duty Cycle³	Monthly, letter: Up to 1000 pages
Recommended Monthly Page Volume	100 to 400
Media Types Supported	Plain paper; Photo paper; Brochure Paper

Media Weight Supported	16 to 24 lb
Media Sizes Supported	Letter (legal), 4 x 6 in, 5 x 7 in, 8 x 10 in, No. 10 envelopes
Media Sizes Custom	3 x 5 to 8.5 x 14 in
Paper Handling	Up to 100 sheets; 25-sheet output tray; Duplex Options: Automatic (standard); Envelope Feeder: No; Standard Paper Trays: 1; Input Capacity: Up to 100 sheets standard; Up to 10 envelopes; Up to 40 cards; Up to 100 sheets (legal); Output Capacity: Up to 25 sheets standard; Up to 5 Envelopes
What's in the box	POWER: HP ENVY 4520 All-in-One Printer; HP G3 Setup Black Instant Ink Ready Cartridge (-190 pages); HP G3 Setup Tri-color Instant Ink Ready Cartridge (-100 pages); Software CD; Setup Flyer; Power cord; Print Guide.
Replacement Cartridge	HP G3 Black Ink Cartridge (-190 pages); HP G3 Tri-color Ink Cartridge (-100 pages); HP G3K Black Ink Cartridge (-480 pages); HP G3K Tri-color Ink Cartridge (-330 pages)
Instant Ink eligible⁴	Instant Ink Ready ⁵ / Save up to 50% on ink. For more information visit http://www.hpinstantink.com
Product Dimensions¹	W x D x H: 17.52 x 14.45 x 5.04 in; Maximum: 17.53 x 22.22 x 5.04 in
Product Weight¹	11.93 lb
Warranty Features	One-year limited hardware warranty; For more info please visit us at http://support.hp.com
Energy Efficiency Compliance	ENERGY STAR® certified
Display Description	5.5 cm (2.2") Hi-Res Mono LCD
Software Included	HP Printer Software, HP Update, HP Photo Creations
Compatible Operating Systems	Windows 10, Windows 8.1, Windows 8, Windows 7, Windows Vista, Windows XP SP3 (32-bit); OS X v10.8 Mountain Lion, OS X v10.9 Mavericks, OS X v10.10 Yosemite
Minimum System Requirements	PC: Windows 10, 8.1, 8, 7: 32-bit or 64-bit, 2 GB available hard disk space, CD-ROM/DVD drive or Internet connection, USB port, Internet Explorer; Windows Vista: 2 GB available hard disk space, CD-ROM/DVD drive or Internet connection, USB port, Internet Explorer 8; Windows XP SP3 or higher (32-bit only); Intel Pentium II, Celeron or 233 MHz compatible processor; 650 MB available hard disk space, CD-ROM/DVD drive or Internet connection, USB port, Internet Explorer 8; MAC: Apple® OS X Yosemite (v10.10) OS X Mavericks (v10.9), OS X Mountain Lion (v10.8); 1 GB HD; Internet required; USB
Power³	Power Supply Type: Built-in Universal Power Supply; Power Requirements: 100-240 Vac, 50/60 Hz 0.7 A; Power Consumption: Up to 15 watts (Printing), 3.05 watts (Ready), 0.55 watts (Sleep), 0.13 watts (Off)
Acoustics	Acoustic Power Disturbance: Print color, simplex, normal mode, A4 paper 6.1 dBA; Print mono, simplex, normal mode, A4 paper 6.4 dBA; Print color, simplex, quiet mode, A4 paper 5.5 dBA; Print mono, simplex, quiet mode, A4 paper 5.7 dBA; Acoustic Pressure Disturbance: 49 dBA (A) color; 51 dBA (A) mono
Operating Environment	Operating Temperature Range: 41 to 104°F; Recommended Operating Temperature: 59 to 90°F; Storage Temperature Range: -40 to 140°F; Non-Operating Humidity Range: 20% to 80% RH non-condensing; Operating Humidity Range: 20% to 80% RH non-condensing; Recommended Humidity Operating Range: 20% to 80% RH non-condensing
HP Service and Support Options	UEM2SE - HP 2 Year Care Pack Business Priority Support with Next Business Day Exchange; UEM2TE - HP 3 Year Care Pack Business Priority Support with Next Business Day Exchange; UEM2BE - HP 4 Year Care Pack Business Priority Support with Next Business Day Exchange

Learn more at hp.com

¹ Dimensions vary by per configuration. ² Weight varies by per configuration. ³ Power requirements are based on the country/region where the printer is sold. Do not convert operating voltages. This will damage the printer and void the product warranty. ⁴ Wireless performance is dependent upon physical environment and distance from the access point. Wireless operations are compatible with 2.4 GHz routers only, excludes wireless direct. Wireless direct may require driver or app to be installed and connected on wireless-enabled mobile device or PC. Wireless functionality may vary by computer and mobile operating systems, see hp.com/connected.com. HP ePrint requires account registration, HP ePrint-enabled printer, Internet connection, and a wireless-enabled mobile device or Internet-connected computer with email capability. Separately purchased data plans or usage fees may apply. Print times and connection speeds may vary. AirPrint supports OS® Lion, OS® Mountain Lion and the following devices running OS 4.2 or later: iPad®, iPhone® (3GS or later), iPod touch® (3rd generation or later) and requires the printer be connected to the same network as your OS X or iOS device. AirPrint, the AirPrint Logo, iPad, iPhone, and iPod touch are trademarks of Apple Inc. Windows is a trademark of the Microsoft group of companies. BlackBerry® names and logos are the property of Research In Motion Limited. Android is a trademark of Google Inc. ⁵ Speed specifications have been updated to reflect current industry testing methods. ⁶ Either after first page or after first set of 50 red pages. For details see <http://www.hp.com/go/updates>. ⁷ HP recommends that the number of printed pages per month be within the stated range for optimum device performance, based on factors including supplies replacement. ⁸ Savings claim is based on HP Instant Ink Service plan price for 12 months using all pages (inkjet) without purchase of additional pages compared with the cost per page (CPP) of the majority of color inkjet printers (<\$300 US), market data reported by IDC Q2 2014. CPP comparisons for standard-capacity inkjet supplies are based on estimated street price and page yield as reported by Gartner Intelligence HFP Weekly and IFC Weekly Reports R2002014. Actual savings may vary depending on number of pages actually printed per month and content of pages printed.

© Copyright 2015 - 2016 HP Development Company, L.P. The information contained herein is subject to change without notice. The only warranties for HP products and services are set forth in the express warranty statements accompanying such products and services. Nothing herein should be construed as constituting an additional warranty. HP shall not be liable for technical or editorial errors or omissions contained herein. ENERGY STAR and the ENERGY STAR logo are registered U.S. marks. Windows is a registered trademark of Microsoft Corporation. AirPrint, iPad, iPhone, and iPod touch are trademarks of Apple Inc., registered in the U.S. and other countries.



May 2016, R3



The power of choice

JPay was acquired by Securus Technologies in July 2015, disrupting the corrections industry with a merger between the two industry leaders in inmate communications and technology. The union of both companies creates a unique opportunity for customers to choose the distribution model that best fits their agency's needs.



1 Purchase Model (JPay)

Ideal for prisons and long-term facilities

- > Inmates purchase and own JP5s tablets *(friends/family can also purchase on their behalf)*
- > Inmates only purchase what they want: music, games, eBooks, eCards and other products as desired
- > JPay's Lantern, a comprehensive education program is available for free
- > Revenue sharing available
- > Tablet unlocked when inmate is released and is theirs to keep
- > Apps included at no cost: three games, FM radio, stopwatch and more

2 Rental Model (Securus)

Ideal for jails and juvenile facilities

- > SecureView technology on the JP5s hardware
- > Inmates rent JP5s tablets on a monthly basis *(friends/family fund the subscription fee, other options available per facility need)*
- > Subscription model; all available services are available to the user at no cost*
- > Facility commands/controls tablet behavior remotely
- > Edovo Education Program available by subscription

One great tablet. Two distribution models.

- | | |
|--|---|
| <ul style="list-style-type: none"> > Industry leading corrections-grade hardware > Over 80,000 devices currently deployed > Clear polycarbonate shock-resistant body > Android-based operating system > Lithium rechargeable battery | <ul style="list-style-type: none"> > WiFi enabled > Integrated, Gen II passive RFID > Device only compatible with JP5 peripherals > Remote monitoring |
|--|---|

About Securus and JPay

Serving more than 3,450 public safety, law enforcement and corrections agencies and over 1,200,000 inmates across North America, Securus Technologies is committed to serve and connect by providing emergency response, incident management, public information, investigation, biometric analysis, communication, information management, inmate self-service, and monitoring products and services in order to make our world a safer place to live. Securus Technologies acquired JPay in July 2015, growing the company's portfolio of leading corrections offerings. JPay is operational in 34 states, partnering with corrections agencies to provide innovative services with real-world practicality – Money Transfer, Education, Release Cards, Email, eCards, Video Visitation, VideoGram, Games, Tablets, and more – to released offenders, inmates and their friends and families. Securus Technologies® focuses on connecting what matters and JPay keeps loved ones connected – a unified message to all customers.

Find out which tablet model is right for your facility

www.SecurusTechnologies.com | sales@Securus.com

www.JPay.com | sales@JPay.com | 954.862.6916



PortaView 20 Junior



Krown-TDDs PortaView PV20 Junior delivers superior communications for all your telephone calls!

Krown-TTys reputation of providing the most technologically advanced and highest quality TDDs at affordable prices is reflected in the PortaView 20 Jr. feature for feature, the PV20 Junior is an excellent value when compared with other ttys available today. It utilizes the same degree of quality engineering to provide years of the highest reliability and outstanding performance.

FEATURES

- 4-Row Keyboard
- 20 Character Display
- Heavy-Duty Rechargeable Battery
- Rugged Injection-Molded Case
- Acoustic cups to fit Round and Square Handset
- Pre-recorded greeting messages
- GA - SK combination keys for easy typing
- Physical Dimension
Weight: 2.7 lbs (1.36 kg) with batteries
Size: W 10" (25.4 cm), L 10" (25.4 cm), H 2.5" (6.5 cm)
- Baudot Code 45.5
- 1 Start Bit, 5 Databits, 1 Stop Bit
- 120V AC Adapter with 9V custom 1700 mAh battery



OPTIONAL:

- TTY Bag
- Dust Cover
- Cell Phone Connector

Krown Manufacturing, Inc.
3408 Indale Road
Fort Worth, TX 76116
Voice: (817) 738-2485
TTY: (817) 738-8993
Fax: (817) 738-1970
E-mail: info@KrownMfg.com
Website: www.KrownMfg.com

NOTE: Krown products carry a 1-Year Limited Warranty

NetVanta

3140

Fixed Port Secure Access Ethernet Router



Benefits

- 100 Mbps router with three Gigabit Ethernet interfaces
- Provides capability for Ethernet redundancy
- USB interface for integrated 3G/4G backup
- Voice Quality Monitoring (VQM) and Mean Opinion Score (MOS) prediction
- Utilizes standards-based routing protocols utilized by the widely deployed NetVanta Series
- Compatible with industry leading switches and call agents
- Dynamic bandwidth allocation affords more efficient utilization
- Stateful Inspection firewall for network security
- Quality of Service (QoS) for delay and jitter sensitive traffic like VoIP
- Supports 802.1q Virtual LAN (VLAN) Trunking
- Optional IPSec Virtual Private Network (VPN) for secure corporate connectivity across the Internet
- Command Line Interface (CLI) mimics industry de facto standard
- Network Address Translation (NAT) for IP address concealment
- Wi-Fi® Access Controller for centralized management of NetVanta Wireless Access Points (WAPs)
- Feature-rich ADTRAN® Operating System (AOS)
- Available in desktop or rack mountable versions
- Industry-leading, North American five-year warranty
- Optional full featured eSBC for robust network security and voice interoperability

Overview

The NetVanta® 3140 is a fixed-port, high-performance Ethernet router supporting converged access and high-quality voice services. It provides three routed, autosensing Gigabit Ethernet interfaces. This product is ideal for carrier-bundled service offerings, and enterprise class Internet access for secure, high-speed corporate connectivity. The NetVanta 3140 is available as either a desktop, or rack mountable platform.

Flexibility and Redundancy

The NetVanta 3140 is ideal for multiple applications where Ethernet redundancy is needed given the three Gigabit ports that can be either LAN or WAN facing. This can be achieved with two Ethernet delivered access services providing immediate failover to the active link anytime a link down event occurs. In addition, the NetVanta 3140 features USB interface that can be used for 3G/4G backup.

Many deployments still feature separate voice and data networks, and the NetVanta 3140 is a perfect fit for these as well with a single WAN link, the other two Gigabit interfaces can accomplish this.

Standards Protocols

The versatile hardware platform of the NetVanta 3140 is further complemented with the AOS. The AOS allows for the support of static and default routes, demand and policy based routing, and allows for fast, accurate network convergence using

routing protocols such as BGP, OSPF, RIP, and PIM Sparse Mode for multicast routing. Multihoming is also available to provide redundant or backup WAN links to multiple ISPs, guaranteeing a wide-area connection.

Hierarchical QoS

QoS is also supported for delay-sensitive traffic like VoIP or video. To prioritize mission-critical traffic and control network congestion, the NetVanta 3140 uses Low Latency Queuing, Weighted Fair Queuing (WFQ), Class-based WFQ, and DiffServ marking to establish the priority of IP packets routed over the WAN.

VoIP Ready

In combination with the QoS features, a specialized SIP ALG allows SIP traffic to traverse NAT-enabled firewalls. For enterprise networks, this interoperability allows IP PBXs, phones, and other SIP-based devices to set up, tear down, and pass voice and call control messages seamlessly through the integral NAT-enabled firewall.

The NetVanta 3140 also deploys VQM to capture MOS, jitter, delay, and packet loss statistics necessary to troubleshoot VoIP calls over the WAN. This powerful, yet graphically intuitive, diagnostic tool allows for quick isolation of network issues to ensure superior call quality.



NETVANTA 3140

Enterprise Session Border Control (eSBC)

The NetVanta 3140 can provide optional eSBC functionality delivering a truly converged application platform at the customer premises. This feature is becoming mandatory in today's service deployment to normalize, secure and troubleshoot the SIP to SIP communication between a carrier network and the customers SIP compliant equipment.

Security

The AOS provides a powerful, high-performance stateful inspection firewall. The firewall can identify and protect against common Denial of Service (DoS) attacks like TCP syn flooding, IP spoofing, ICMP redirect, ping-of-death, and IP reassembly problems.

In addition, the AOS is capable of providing an inherent URL-filtering package without the use of an external server. URL filtering is another level of security that allows system administrators to restrict Internet access by permitting or denying specific URLs. This URL-filtering feature also includes the ability to produce top website reports of the most frequently requested websites, allowing system administrators to modify the URL filter lists.

The NetVanta 3140 also adds the support for IPSec compliant VPN. The NetVanta 3140 supports encryption algorithms like DES, 3DES, and AES. With this upgrade, the NetVanta 3140 is fully compatible with other IPSec VPN equipped NetVanta products.

Management

The NetVanta 3140 Series can be remotely managed by ADTRAN's n-Command[®] MSP platform. ADTRAN n-Command platforms offer the ability to discover devices, make mass configuration changes or firmware upgrades, backup/restore configuration, and generate inventory reports for asset management. The ADTRAN n-Command MSP also offers VoIP VQM and reporting, as well as an industry-leading, easy-to-use, Graphical User Interface (GUI). NetVanta 3140 is available in rack mountable, and desktop versions; and are backed by an industry-leading warranty.

Administration

The AOS offers an intuitive Web-based GUI that provides step-by-step configuration wizards, management capability, and the ability to upload firmware updates. In addition, it has a standard CLI that mimics the widely adopted, industry de facto standard. The sequence of commands required to configure similar devices is almost identical, eliminating training costs typically associated with learning a new operating system or obtaining costly industry certifications. The CLI also allows for configuration scripts to be used, saved, and downloaded as a quick-and-easy recovery mechanism.

Product Specifications

Physical Interfaces

- Ethernet
- Full Duplex
- Auto-negotiation
- RJ-45
- USB 2.0
- One Port
- Console Port
- Three Gigabit Ethernet Interfaces (WAN/LAN Support)
- Supports 802.1q VLAN Trunking
- EIA-232 Providing Local Management and Configuration (via a DB-9 Female Connector)

Diagnostic LEDs

- Stat (Power)
- Gig 1, Gig 2, Gig 3 (Ethernet)
- USB

Protocols

- EBGPA/BGP
- RIP (v1 and v2)
- PIM Sparse Mode
- IGMP V2
- GRE
- PPP Dial Backup
- PAP and CHAP
- Multi-VRF CE ■ VRRP
- Policy-based Routing
- OSPF
- PPPoE
- Multilink PPPoE
- Demand Routing
- RFC 1483
- Multihoming
- Layer 3 Backup
- TWAMP

Fixed Port Secure Access Ethernet Router

Quality of Service (QoS)

- Low Latency and Weighted Fair Queuing (WFQ)
- Class-Based WFQ
- DiffServ Packet Marking and Recognition
- Traffic Monitoring (NetFlow 9)

Voice Quality Monitoring (VQM)

- Mean Opinion Score (MOS) Prediction
- Jitter, Delay and Packet Loss
- Past and Active Calls

Traffic and Network Quality Monitoring

- ICMP and TWAMP Probes and Tracks
- One-Way Delay
- Round-Trip Loss and Delay
- Inter-Packet Delay Variance
- Traffic Flow Collection and Analysis
- Packet Capture

Administration

- Familiar Command Line Interface (CLI)
- Web-Based GUI
- n-Command Support
- SNMP V2 and V3
- SYSLOG Logging
- Email Alerts (SMTP)
- Policy Statistics
- TCL Scripting
- Login Privilege Levels
- Telnet, Craft/Console Port, SSH, Ping, Trace Route and NTP

DHCP

- Client, Server and Relay

Firewall

- Stateful Inspection Firewall
- Denial of Service (DOS) Protection
- Access Control Lists
- Application Level Gateways
- Packet Filtering

Network Address Translation

- Basic NAT (1:1), NATP (Many:1) and 1:1 Port Translation
- NAT-compatible SIP ALG

NAT Traversal and Remote Survivability

- B2BUA
- SIP Registrar for IP Phones
- SIP Proxy with Survivability
- Transparent/Stateful/Outbound

Content Filtering

- Inherent URL Filtering
- Top Website Reports
- Integration with Websense

Secure Management

- Multi-level Access Control
- TACACS+
- RADIUS AAA
- SSH CLI and SSL GUI
- Port Authentication (802.1x)

VPN (Optional)

- IPSec Tunnel Mode: 500 Tunnels
- Encryption: DES, 3DES and AES
- Authentication Mechanisms: XAUTH, Digital Certificates, Pre-shared Keys and Secure ID

Environment

- Operating Temperature: 32° to 122° F (0° to 50° C)
- Storage Temperature: -40° to 158° F (-20° to 70° C)
- Relative Humidity: Up to 95%, Non-condensing

Physical and Power

NetVanta 3140

- Self Standing, Desktop Plastic Enclosure
- Dimensions: 1.63 in. x 9 in. x 6.38 in. (H x W x D), (4.14 cm x 22.86 cm x 16.21 cm)
- Weight: 1 lbs. (.45 kg)
- Power: DC (12 VDC, 1.0 A)

NetVanta 3140 RM

- 1U Metal Rackmount
- Dimensions: 1.72 in. x 8.4 in. x 8 in. (H x W x D), (4.36 cm x 21.3 cm x 20.3 cm)
- Weight: 3 lbs. (1.4 kg)
- Power: AC (Auto-ranging, 100 to 250 VAC, 50/60 Hz, 0.4 A Maximum)

Agency Approvals

- FCC Part 15 Class A
- CE Mark
- UL & Canadian UL
- RoHS
- C-Tick for Australia and New Zealand

Ordering Options

Hardware Options	Part No.
Multi-Service Edge Switch	
NetVanta 3140 Desktop	1700840F1
NetVanta 3140	1700841F1
NetVanta 3140 Desktop with VPN and VQM	4700840F2
NetVanta 3140 with VPN and VQM	4700841F2
VPN and VQM Software Upgrade	1950840F2
19 in. Rackmount Brackets*	1700511F1
19 in. Dual Mounting Tray*	1700508F1
Wall Mount*	1200884G1
Dual Wall Mount*	1700512F1
NetVanta 3140 with SBC, 5 Calls	4700841F2#5
NetVanta 3140 with SBC, 10 Calls	4700841F2#10
NetVanta 3140 with SBC, 25 Calls	4700841F2#25
NetVanta 3140 with SBC, 50 Calls	4700841F2#50
NetVanta 3140 with SBC, 100 Calls	4700841F2#100
NetVanta 3140 with SBC, 300 Calls	4700841F2#300
Software Options	
NetVanta 3140 SBC Upgrade, 5 Calls	1963SBCF5
NetVanta 3140 SBC Upgrade, 10 Calls	1963SBCF10
NetVanta 3140 SBC Upgrade, 25 Calls	1963SBCF25
NetVanta 3140 SBC Upgrade, 50 Calls	1963SBCF50
NetVanta 3140 SBC Upgrade, 100 Calls	1963SBCF100
NetVanta 3140 SBC Upgrade, 300 Calls	1963SBCF300

* Accessories apply to NetVanta 3140 (non-desktop version) only



ADTRAN, Inc.
901 Explorer Boulevard
Huntsville, AL 35895
256 963-8000

General Information
800 9ADTRAN
www.adtran.com/contactus

Canada Headquarters – Toronto,
Ontario
+1 877 923 8726
+1 905 825 2515
sales.canada@adtran.com

Canada – Montreal, Quebec
+1 877 923 8726
+1 514 940 2888
sales.canada@adtran.com

Mexico and Central America
+1 256 963 3321
+1 52 55 5280 0285 Mexico
sales.casat@adtran.com

South America
+1 256 963 3185
sales.brnc@adtran.com
sales.latan@adtran.com

61700340F1-02

May Copyright © 2018 ADTRAN, Inc. All rights reserved. ADTRAN follows the information in this publication to be accurate as of publication date, and is not responsible for errors. Specifications subject to change without notice. ADTRAN and NetVanta are registered trademarks of ADTRAN, Inc. and its affiliates in various countries. All other trademarks mentioned in this document are the property of their respective owners.

ADTRAN warranty duration and conditions vary by product and geography. For specific warranty information, visit www.adtran.com/warranty.

ADTRAN products may be subject to U.S. export controls and other trade restrictions. Any export, re-export, or transfer of the products contrary to law is prohibited. For more information regarding ADTRAN's export status, please visit www.adtran.com/exportstatus.



Mini Blue

7010BL



- Built-in user controlled volume "LOUD" button for ADA mandated volume control (must be user-controlled volume amplification AND volume must be reset to normal with on-hook to meet ADA requirements).
- Powder Coated cold rolled steel provides rugged vandal resistant telephone housing designed for inmate use.
- Confidenceer technology, built into every dial, filters out background noise at the user's location, allowing better sound to the called party.
- All-in-one electronic dial features modular incoming line and handset connections for quick maintenance. Carbon (HS) and DuraClear (DURA) Handsets have separate 4-pin connections.
- Heavy chrome metal keypad bezel, buttons, and hookswitch lever withstand abuse and vandalism.
- Armored handset cord is equipped with a steel lanyard (1000# pull strength) and secured with a 14 gauge retainer bracket for maximum vandal resistance.
- Handset has sealed transmitter and receiver caps, suitable for heavy use and abuse locations.
- Pin-in-head security screws minimize tampering.
- Hearing aid compatible and FCC registered US:1DATT05BITC-254, IC:3267A-ITC254.

ACCESSORIES:

- Handset length and style of your choice, choose carbon or DuraClear
- Standard 178A Backboard for mounting
- Adapter Plate for mounting Mini Phones to 178A Backboards and pedestals
- Conduit Backboard with two (2) or (4) entry positions
- Standard Flush Mount Pedestal
- Adjustable Pedestal
- 4 Wheel Rollcart



Wintel®

A Division of Independent Technologies, Inc.

1051 Bennell Drive, Suite 101 • Longwood, FL 32750
407 834 1188 • Fax 407 830 1050 • 800 264 8886
www.wintelphones.com

Tall Blue

7042BL



Wintel[®]

A Division of Independent Technologies, Inc.

1051 Bennett Drive, Suite 101 • Longwood, FL 32750
 407.834.1188 • Fax 407.830.1050 • 800.264.8886
www.wintelphones.com

- All-in-one electronic dial features modular incoming line and handset connections for quick maintenance. Carbon (TIS) and DuraClear (DURA) Handsets have separate 4-pin connections.
- Built-in user controlled volume "LOUD" button for ADA mandated volume control (must be user-controlled volume amplification AND volume must be reset to normal with on-hook to meet ADA requirements).
- Powder Coated cold rolled steel provides rugged vandal resistant telephone housing designed for inmate use.
- Confidenceer technology, built into every dial, filters out background noise at the user's location, allowing better sound to the called party.
- Heavy chrome metal keypad bezel, buttons, and hookswitch lever withstand abuse and vandalism.
- Armored handset cord is equipped with a steel lanyard (1000# pull strength) and secured with a 14 gauge retainer bracket for maximum vandal resistance.
- Handset has sealed transmitter and receiver caps, suitable for heavy use and abuse locations.
- Pin-in-head security screws minimize tampering
- Hearing aid compatible and FCC registered
 US: IDATE05BITC-254, IC:3267A-ITC254.

ACCESSORIES:

- Handset length and style of your choice, choose carbon or DuraClear
- Standard 178A Backboard for mounting
- Conduit Backboard with four entry positions
- Standard Flush Mount Pedestal
- Adjustable Pedestal
- 4 Wheel Rollcart



COMPLETED FORMS

Completed Forms

Procurement Lobbying Certification

Procurement Lobbying Certification

By signing, the Offerer/bidder affirms that it understands and agrees to comply with the NYS Department of Corrections and Community Supervision (DOCCS) procedures relative to permissible contacts, as required by State Finance Law §139-j and §139-k.

Procurement Lobbying information can be accessed using the following links:

<http://www.oqs.ny.gov/aboutoqs/regulations/advisoryCouncil/sf139-j.htm> and
<http://www.oqs.ny.gov/aboutoqs/regulations/advisoryCouncil/sf139-k.htm>

Offerer affirms that it understands and agrees to comply with the procedures of DOCCS relative to permissible Contacts as required by State Finance Law §139-j (3) and §139-k (b) (5).

By:  Date: January 19, 2017

Name: Robert E. Pickens Title: President

Contractor Name: Securus Technologies, Inc.

Contractor Address: 1465 Dallas Parkway, Ste. 600, Dallas, TX 75254-8515

Prior Non-Responsibility Determinations – State Finance Law §139-k

1. Has any Government Entity made a finding of non-responsibility against this organization/company? No Yes
2. If yes, was the basis for the finding of non-responsibility due to a violation of SFL§139-j or due to the intentional provision of false or incomplete information to a Government Entity?
No Yes NA
3. Has any Government Entity terminated or withheld a procurement contract with this organization/company due to the intentional provision of false or incomplete information?
No Yes

If yes to any of the above questions, provide complete details on a separate page and attach.

Offerer Certification:

I certify that all information provided to DOCCS with respect to State Finance Law §139-k is complete, true and accurate.

By:  Date: 1/19/2017

Name: Robert E. Pickens Title: President

Procurement Lobbying Termination

DOCCS reserves the right to terminate this contract in the event it is found that the certification filed by the Offerer/bidder in accordance with New York State Finance Law §139-k was intentionally false or intentionally incomplete. Upon such finding, DOCCS may exercise its termination right by providing written notice to the Offerer/bidder in accordance with the written notification terms of the contract.

Securus Technologies, Inc.

Securus Technologies, Inc.

Securus Technologies, Inc.

Completed Forms

Vendor Responsibility Questionnaire (Appendix E)

NEW YORK STATE
VENDOR RESPONSIBILITY QUESTIONNAIRE
FOR-PROFIT BUSINESS ENTITY

Certification

The undersigned: (1) recognizes that this questionnaire is submitted for the express purpose of assisting New York State government entities (including the Office of the State Comptroller (OSC)) in making responsibility determinations regarding award or approval of a contract or subcontract and that such government entities will rely on information disclosed in the questionnaire in making responsibility determinations; (2) acknowledges that the New York State government entities and OSC may, in their discretion, by means which they may choose, verify the truth and accuracy of all statements made herein; and (3) acknowledges that intentional submission of false or misleading information may result in criminal penalties under State and/or Federal Law, as well as a finding of non-responsibility, contract suspension or contract termination.

The undersigned certifies that he/she:

- is knowledgeable about the submitting Business Entity's business and operations;
- has read and understands all of the questions contained in the questionnaire;
- has not altered the content of the questionnaire in any manner;
- has reviewed and/or supplied full and complete responses to each question;
- to the best of his/her knowledge, information and belief, confirms that the Business Entity's responses are true, accurate and complete, including all attachments, if applicable;
- understands that New York State government entities will rely on the information disclosed in the questionnaire when entering into a contract with the Business Entity; and
- is under an obligation to update the information provided herein to include any material changes to the Business Entity's responses at the time of bid/proposal submission through the contract award notification, and may be required to update the information at the request of the New York State government entities or OSC prior to the award and/or approval of a contract, or during the term of the contract.

Signature of Owner/Official 

Printed Name of Signatory Robert E. Pickens

Title President

Name of Business Securus Technologies, Inc.

Address 14651 Dallas Parkway Ste. 600

City, State, Zip Dallas, Texas 75254-8816

Sworn to before me this 19 day of January, 2017:

 Notary Public

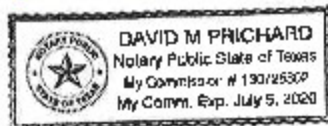

**NEW YORK STATE
VENDOR RESPONSIBILITY QUESTIONNAIRE
FOR-PROFIT BUSINESS ENTITY**

You have selected the For-Profit Non-Construction questionnaire which may be printed and completed in this format or, for your convenience, may be completed online using the New York State VendRep System.

COMPLETION & CERTIFICATION

The person(s) completing the questionnaire must be knowledgeable about the vendor's business and operations. An owner or officer must certify the questionnaire and the signature must be notarized.

NEW YORK STATE VENDOR IDENTIFICATION NUMBER (VENDOR ID)

The Vendor ID is a ten-digit identifier issued by New York State when the vendor is registered on the Statewide Vendor File. This number must now be included on the questionnaire. If the business entity has not obtained a Vendor ID, contact the IT Service Desk at ITServiceDesk@osc.state.ny.us or call 866-370-4672.

DEFINITIONS

All underlined terms are defined in the "New York State Vendor Responsibility Definitions List," found at www.osc.state.ny.us/vendors/documents/questionnaire/definitions.pdf. These terms may not have their ordinary, common or traditional meanings. Each vendor is strongly encouraged to read the respective definitions for any and all underlined terms. By submitting this questionnaire, the vendor agrees to be bound by the terms as defined in the "New York State Vendor Responsibility Definitions List" existing at the time of certification.

RESPONSES

Every question must be answered. Each response must provide all relevant information which can be obtained within the limits of the law. However, information regarding a determination or finding made in error which was subsequently corrected is not required. Individuals and Sole Proprietors may use a Social Security Number but are encouraged to obtain and use a federal Employer Identification Number (EIN).

REPORTING ENTITY

Each vendor must indicate if the questionnaire is filed on behalf of the entire Legal Business Entity or an Organizational Unit within or operating under the authority of the Legal Business Entity and having the same EIN. Generally, the Organizational Unit option may be appropriate for a vendor that meets the definition of "Reporting Entity" but due to the size and complexity of the Legal Business Entity, is best able to provide the required information for the Organizational Unit, while providing more limited information for other parts of the Legal Business Entity and Associated Entities.

ASSOCIATED ENTITY

An Associated Entity is one that owns or controls the Reporting Entity or any entity owned or controlled by the Reporting Entity. However, the term Associated Entity does not include "sibling organizations" (i.e., entities owned or controlled by a parent company that owns or controls the Reporting Entity), unless such sibling entity has a direct relationship with or impact on the Reporting Entity.

STRUCTURE OF THE QUESTIONNAIRE

The questionnaire is organized into eleven sections. Section I is to be completed for the Legal Business Entity. Section II requires the vendor to specify the Reporting Entity for the questionnaire. Section III refers to the individuals of the Reporting Entity, while Sections IV-VIII require information about the Reporting Entity. Section IX pertains to any Associated Entities, with one question about their Officials/Owners. Section X relates to disclosure under the Freedom of Information Law (FOIL). Section XI requires an authorized contact for the questionnaire information.

**NEW YORK STATE
VENDOR RESPONSIBILITY QUESTIONNAIRE
FOR-PROFIT BUSINESS ENTITY**

I. LEGAL BUSINESS ENTITY INFORMATION			
Legal Business Entity Name* Securus Technologies, Inc.		EIN [REDACTED]	
Address of the Principal Place of Business (street, city, state, zip code) 14651 Dallas Parkway, Ste. 600 Dallas, TX 75254-8815		New York State Vendor Identification Number [REDACTED]	
		Telephone (972) 277-0300 ext.	Fax (972) 277-0514
Email bpickers@securustechnologies.com		Website www.securustechnologies.com	
Additional Legal Business Entity Identities: If applicable, list any other DBA, Trade Name, Former Name, Other Identity, or EIN used in the last five (5) years and the status (active or inactive).			
Type	Name	EIN	Status
1.0 Legal Business Entity Type – Check appropriate box and provide additional information:			
<input checked="" type="checkbox"/> Corporation (including PC)		Date of Incorporation 12/30/1998	
<input type="checkbox"/> Limited Liability Company (LLC or PLLC)		Date of Organization	
<input type="checkbox"/> Partnership (including LLP, LP or General)		Date of Registration or Establishment	
<input type="checkbox"/> Sole Proprietor		How many years in business?	
<input type="checkbox"/> Other		Date Established	
If Other, explain:			
1.1 Was the Legal Business Entity formed or incorporated in New York State?			<input type="checkbox"/> Yes <input checked="" type="checkbox"/> No
If "No," indicate jurisdiction where Legal Business Entity was formed or incorporated and attach a Certificate of Good Standing from the applicable jurisdiction or provide an explanation if a Certificate of Good Standing is not available.			
<input checked="" type="checkbox"/> United States		State	DE
<input type="checkbox"/> Other		Country	_____
Explain, if not available:			
1.2 Is the Legal Business Entity publicly traded?			<input type="checkbox"/> Yes <input checked="" type="checkbox"/> No
If "Yes," provide CIK Code or Ticker Symbol			
1.3 Does the Legal Business Entity have a DUNS Number?			<input checked="" type="checkbox"/> Yes <input type="checkbox"/> No
If "Yes," Enter DUNS Number 19-285-8954			

*All underlined terms are defined in the "New York State Vendor Responsibility Definitions List," which can be found at www.osc.state.ny.us/vendrep/documents/questionnaire/definitions.pdf

**NEW YORK STATE
VENDOR RESPONSIBILITY QUESTIONNAIRE
FOR-PROFIT BUSINESS ENTITY**

I. LEGAL BUSINESS ENTITY INFORMATION		
1.4 If the <u>Legal Business Entity</u> 's <u>Principal Place of Business</u> is not in New York State, does the <u>Legal Business Entity</u> maintain an office in New York State? (Select "N/A," if <u>Principal Place of Business</u> is in New York State.)		<input type="checkbox"/> Yes <input checked="" type="checkbox"/> No <input type="checkbox"/> N/A
If "Yes," provide the address and telephone number for one office located in New York State.		
1.5 Is the <u>Legal Business Entity</u> a New York State certified <u>Minority-Owned Business Enterprise (MBE)</u> , <u>Women-Owned Business Enterprise (WBE)</u> , <u>New York State Small Business (SB)</u> or a federally certified <u>Disadvantaged Business Enterprise (DBE)</u> ? If "Yes," check all that apply:		<input type="checkbox"/> Yes <input checked="" type="checkbox"/> No
If "Yes," check all that apply: <input type="checkbox"/> New York State certified <u>Minority-Owned Business Enterprise (MBE)</u> <input type="checkbox"/> New York State certified <u>Women-Owned Business Enterprise (WBE)</u> <input type="checkbox"/> <u>New York State Small Business (SB)</u> <input type="checkbox"/> Federally certified <u>Disadvantaged Business Enterprise (DBE)</u>		
1.6 Identify <u>Officials</u> and <u>Principal Owners</u> , if applicable. For each person, include name, title and percentage of ownership. Attach additional pages if necessary. If applicable, reference to relevant SEC filing(s) containing the required information is optional.		
Name	Title	Percentage Ownership <i>(Enter 0% if not applicable)</i>
Rick A. Smith	Chief Executive Officer	0%
Robert E. Pickens	President	0%
Geoffrey Boyd	Chief Financial Officer	0%
Dennis J. Reinhold	Vice-President, General Counsel and Secretary	0%

**NEW YORK STATE
VENDOR RESPONSIBILITY QUESTIONNAIRE
FOR-PROFIT BUSINESS ENTITY**

II. REPORTING ENTITY INFORMATION	
<p>2.0 The <u>Reporting Entity</u> for this questionnaire is:</p> <p>Note: Select only one.</p> <p><input checked="" type="checkbox"/> <u>Legal Business Entity</u></p> <p><i>Note: If selecting this option, "Reporting Entity" refers to the entire <u>Legal Business Entity</u> for the remainder of the questionnaire. (SKIP THE REMAINDER OF SECTION II AND PROCEED WITH SECTION III.)</i></p> <p><input type="checkbox"/> <u>Organizational Unit</u> within and operating under the authority of the <u>Legal Business Entity</u></p> <p>SEE DEFINITIONS OF "<u>REPORTING ENTITY</u>" AND "<u>ORGANIZATIONAL UNIT</u>" FOR ADDITIONAL INFORMATION ON CRITERIA TO QUALIFY FOR THIS SELECTION.</p> <p><i>Note: If selecting this option, "Reporting Entity" refers to the <u>Organizational Unit</u> within the <u>Legal Business Entity</u> for the remainder of the questionnaire. (COMPLETE THE REMAINDER OF SECTION II AND ALL REMAINING SECTIONS OF THIS QUESTIONNAIRE.)</i></p>	
IDENTIFYING INFORMATION	
a) <u>Reporting Entity</u> Name	
Address of the <u>Primary Place of Business</u> (street, city, state, zip code)	Telephone ext.
b) Describe the relationship of the <u>Reporting Entity</u> to the <u>Legal Business Entity</u>	
c) Attach an <u>organizational chart</u>	
d) Does the Reporting Entity have a <u>DUNS</u> Number? <input type="checkbox"/> Yes <input type="checkbox"/> No	
If "Yes," enter <u>DUNS</u> Number	
e) Identify the designated manager(s) responsible for the business of the <u>Reporting Entity</u> . <i>For each person, include name and title. Attach additional pages if necessary.</i>	
Name	Title

**NEW YORK STATE
VENDOR RESPONSIBILITY QUESTIONNAIRE
FOR-PROFIT BUSINESS ENTITY**

INSTRUCTIONS FOR SECTIONS III THROUGH VII

For each “Yes,” provide an explanation of the issue(s), relevant dates, the government entity involved, any remedial or corrective action(s) taken and the current status of the issue(s). For each “Other,” provide an explanation which provides the basis for not definitively responding “Yes” or “No.” Provide the explanation at the end of the section or attach additional sheets with numbered responses, including the Reporting Entity name at the top of any attached pages.

III. LEADERSHIP INTEGRITY	
<i>Within the past five (5) years, has any current or former reporting entity official or any individual currently or formerly having the authority to sign, execute or approve bids, proposals, contracts or supporting documentation on behalf of the reporting entity with any government entity been:</i>	
3.0 <u>Sanctioned</u> relative to any business or professional permit and/or license?	<input type="checkbox"/> Yes <input checked="" type="checkbox"/> No <input type="checkbox"/> Other
3.1 <u>Suspended, debarred, or disqualified</u> from any <u>government contracting process</u> ?	<input type="checkbox"/> Yes <input checked="" type="checkbox"/> No <input type="checkbox"/> Other
3.2 The subject of an <u>investigation</u> , whether open or closed, by any <u>government entity</u> for a civil or criminal violation for any business-related conduct?	<input type="checkbox"/> Yes <input checked="" type="checkbox"/> No <input type="checkbox"/> Other
3.3 Charged with a misdemeanor or felony, indicted, granted immunity, convicted of a crime or subject to a <u>judgment</u> for: a) Any business-related activity; or b) Any crime, whether or not business-related, the underlying conduct of which was related to truthfulness?	<input type="checkbox"/> Yes <input checked="" type="checkbox"/> No <input type="checkbox"/> Other
For each “Yes” or “Other” explain:	

IV. INTEGRITY – CONTRACT BIDDING	
<i>Within the past five (5) years, has the reporting entity:</i>	
4.0 Been <u>suspended</u> or <u>debarred</u> from any <u>government contracting process</u> or been <u>disqualified</u> on any government procurement, permit, license, concession, franchise or lease, including, but not limited to, <u>debarment</u> for a violation of New York State Workers’ Compensation or Prevailing Wage laws or New York State Procurement Lobbying Law?	<input type="checkbox"/> Yes <input checked="" type="checkbox"/> No
4.1 Been subject to a denial or revocation of a government prequalification?	<input type="checkbox"/> Yes <input checked="" type="checkbox"/> No
4.2 Been denied a contract award or had a bid rejected based upon a <u>non-responsibility finding</u> by a <u>government entity</u> ?	<input type="checkbox"/> Yes <input checked="" type="checkbox"/> No
4.3 Had a low bid rejected on a <u>government contract</u> for failure to <u>make good faith efforts</u> on any <u>Minority-Owned Business Enterprise</u> , <u>Women-Owned Business Enterprise</u> or <u>Disadvantaged Business Enterprise</u> goal or <u>statutory affirmative action requirements</u> on a previously held contract?	<input type="checkbox"/> Yes <input checked="" type="checkbox"/> No
4.4 Agreed to a voluntary exclusion from bidding/contracting with a <u>government entity</u> ?	<input type="checkbox"/> Yes <input checked="" type="checkbox"/> No
4.5 Initiated a request to withdraw a bid submitted to a <u>government entity</u> in lieu of responding to an information request or subsequent to a formal request to appear before the <u>government entity</u> ?	<input type="checkbox"/> Yes <input checked="" type="checkbox"/> No
For each “Yes,” explain:	

**NEW YORK STATE
VENDOR RESPONSIBILITY QUESTIONNAIRE
FOR-PROFIT BUSINESS ENTITY**

V. INTEGRITY – CONTRACT AWARD	
<i>Within the past five (5) years, has the reporting entity:</i>	
5.0 Been <u>suspended</u> , cancelled or <u>terminated for cause</u> on any <u>government contract</u> including, but not limited to, a <u>non-responsibility finding</u> ?	<input type="checkbox"/> Yes <input checked="" type="checkbox"/> No
5.1 Been subject to an <u>administrative proceeding</u> or civil action seeking specific performance or restitution in connection with any <u>government contract</u> ?	<input type="checkbox"/> Yes <input checked="" type="checkbox"/> No
5.2 Entered into a formal monitoring agreement as a condition of a contract award from a <u>government entity</u> ?	<input type="checkbox"/> Yes <input checked="" type="checkbox"/> No
For each "Yes," explain:	

VI. CERTIFICATIONS/LICENSES	
<i>Within the past five (5) years, has the reporting entity:</i>	
6.0 Had a revocation, <u>suspension</u> or <u>disbarment</u> of any business or professional permit and/or license?	<input type="checkbox"/> Yes <input checked="" type="checkbox"/> No
6.1 Had a denial, decertification, revocation or forfeiture of New York State certification of <u>Minority-Owned Business Enterprise</u> , <u>Women-Owned Business Enterprise</u> or federal certification of <u>Disadvantaged Business Enterprise</u> status for other than a change of ownership?	<input type="checkbox"/> Yes <input checked="" type="checkbox"/> No
For each "Yes," explain:	

VII. LEGAL PROCEEDINGS	
<i>Within the past five (5) years, has the reporting entity:</i>	
7.0 Been the subject of an <u>investigation</u> , whether open or closed, by any <u>government entity</u> for a civil or criminal violation?	<input type="checkbox"/> Yes <input checked="" type="checkbox"/> No
7.1 Been the subject of an indictment, grant of immunity, <u>judgment</u> or conviction (including entering into a plea bargain) for conduct constituting a crime?	<input type="checkbox"/> Yes <input checked="" type="checkbox"/> No
7.2 Received any OSHA citation and Notification of Penalty containing a violation classified as <u>serious</u> or <u>willful</u> ?	<input type="checkbox"/> Yes <input checked="" type="checkbox"/> No
7.3 Had a <u>government entity</u> find a willful prevailing wage or supplemental payment violation or any other willful violation of New York State Labor Law?	<input type="checkbox"/> Yes <input checked="" type="checkbox"/> No
7.4 Entered into a consent order with the New York State Department of Environmental Conservation, or received an enforcement determination by any <u>government entity</u> involving a violation of federal, state or local environmental laws?	<input type="checkbox"/> Yes <input checked="" type="checkbox"/> No
7.5 Other than previously disclosed: a) Been subject to fines or penalties imposed by <u>government entities</u> which in the aggregate total \$25,000 or more; or b) Been convicted of a criminal offense pursuant to any administrative and/or regulatory action taken by any <u>government entity</u> ?	<input type="checkbox"/> Yes <input checked="" type="checkbox"/> No
For each "Yes," explain:	

**NEW YORK STATE
VENDOR RESPONSIBILITY QUESTIONNAIRE
FOR-PROFIT BUSINESS ENTITY**

VIII. FINANCIAL AND ORGANIZATIONAL CAPACITY	
8.0 Within the past five (5) years, has the <u>Reporting Entity</u> received any <u>formal unsatisfactory performance assessment(s)</u> from any <u>government entity</u> on any contract?	<input type="checkbox"/> Yes <input checked="" type="checkbox"/> No
If "Yes," provide an explanation of the issue(s), relevant dates, the <u>government entity</u> involved, any remedial or corrective action(s) taken and the current status of the issue(s). Provide answer below or attach additional sheets with numbered responses.	
8.1 Within the past five (5) years, has the <u>Reporting Entity</u> had any <u>liquidated damages</u> assessed over \$25,000?	<input type="checkbox"/> Yes <input checked="" type="checkbox"/> No
If "Yes," provide an explanation of the issue(s), relevant dates, contracting party involved, the amount assessed and the current status of the issue(s). Provide answer below or attach additional sheets with numbered responses.	
8.2 Within the past five (5) years, have any <u>liens</u> or <u>judgments</u> (not including UCC filings) over \$25,000 been filed against the <u>Reporting Entity</u> which remain undischarged?	<input type="checkbox"/> Yes <input checked="" type="checkbox"/> No
If "Yes," provide an explanation of the issue(s), relevant dates, the Lien holder or Claimant's name(s), the amount of the <u>lien(s)</u> and the current status of the issue(s). Provide answer below or attach additional sheets with numbered responses.	
8.3 In the last seven (7) years, has the <u>Reporting Entity</u> initiated or been the subject of any bankruptcy proceedings, whether or not closed, or is any bankruptcy proceeding pending?	<input type="checkbox"/> Yes <input checked="" type="checkbox"/> No
If "Yes," provide the bankruptcy chapter number, the court name and the docket number. Indicate the current status of the proceedings as "Initiated," "Pending" or "Closed." Provide answer below or attach additional sheets with numbered responses.	
8.4 During the past three (3) years, has the <u>Reporting Entity</u> failed to file or pay any tax returns required by <u>federal</u> , state or local tax laws?	<input type="checkbox"/> Yes <input checked="" type="checkbox"/> No
If "Yes," provide the taxing jurisdiction, the type of tax, the liability year(s), the tax liability amount the <u>Reporting Entity</u> failed to file/pay and the current status of the tax liability. Provide answer below or attach additional sheets with numbered responses.	
8.5 During the past three (3) years, has the <u>Reporting Entity</u> failed to file or pay any New York State unemployment insurance returns?	<input type="checkbox"/> Yes <input checked="" type="checkbox"/> No
If "Yes," provide the years the <u>Reporting Entity</u> failed to file/pay the insurance, explain the situation and any remedial or corrective action(s) taken and the current status of the issue(s). Provide answer below or attach additional sheets with numbered responses.	
8.6 During the past three (3) years, has the <u>Reporting Entity</u> had any <u>government audit(s)</u> completed?	<input checked="" type="checkbox"/> Yes <input type="checkbox"/> No
a) If "Yes," did any audit of the <u>Reporting Entity</u> identify any reported significant deficiencies in internal control, fraud, illegal acts, significant violations of provisions of contract or grant agreements, significant abuse or any <u>material disallowance</u> ?	<input type="checkbox"/> Yes <input checked="" type="checkbox"/> No
If "Yes" to 8.6 a), provide an explanation of the issue(s), relevant dates, the <u>government entity</u> involved, any remedial or corrective action(s) taken and the current status of the issue(s). Provide answer below or attach additional sheets with numbered responses.	

**NEW YORK STATE
VENDOR RESPONSIBILITY QUESTIONNAIRE
FOR-PROFIT BUSINESS ENTITY**

IX. ASSOCIATED ENTITIES <i>This section pertains to any entity(ies) that either controls or is controlled by the reporting entity. (See definition of "associated entity" for additional information to complete this section.)</i>	
9.0 Does the <u>Reporting Entity</u> have any <u>Associated Entities</u> ? Note: All questions in this section must be answered if the <u>Reporting Entity</u> is either: – An <u>Organizational Unit</u> ; or – The entire <u>Legal Business Entity</u> which controls, or is controlled by, any other entity(ies). If "No," SKIP THE REMAINDER OF SECTION IX AND PROCEED WITH SECTION X.	<input checked="" type="checkbox"/> Yes <input type="checkbox"/> No
9.1 Within the past five (5) years, has any <u>Associated Entity Official</u> or <u>Principal Owner</u> been charged with a misdemeanor or felony, indicted, granted immunity, convicted of a crime or subject to a <u>judgment</u> for: a) Any business-related activity; or b) Any crime, whether or not business-related, the underlying conduct of which was related to truthfulness?	<input type="checkbox"/> Yes <input checked="" type="checkbox"/> No
If "Yes," provide an explanation of the issue(s), the individual involved, his/her title and role in the <u>Associated Entity</u> , his/her relationship to the <u>Reporting Entity</u> , relevant dates, the <u>government entity</u> involved, any remedial or corrective action(s) taken and the current status of the issue(s).	
9.2 Does any <u>Associated Entity</u> have any currently undischarged <u>federal</u> , New York State, New York City or New York local government <u>liens</u> or <u>judgments</u> (not including UCC filings) over \$50,000?	<input type="checkbox"/> Yes <input checked="" type="checkbox"/> No
If "Yes," provide an explanation of the issue(s), identify the <u>Associated Entity's</u> name(s), <u>EIN(s)</u> , primary business activity, relationship to the <u>Reporting Entity</u> , relevant dates, the <u>Lien holder or Claimant's</u> name(s), the amount of the <u>lien(s)</u> and the current status of the issue(s). Provide answer below or attach additional sheets with numbered responses.	
9.3 Within the past five (5) years, has any <u>Associated Entity</u> :	
a) Been <u>disqualified</u> , <u>suspended</u> or <u>debarred</u> from any <u>federal</u> , New York State, New York City or other New York local <u>government contracting process</u> ?	<input type="checkbox"/> Yes <input checked="" type="checkbox"/> No
b) Been denied a contract award or had a bid rejected based upon a <u>non-responsibility finding</u> by any <u>federal</u> , New York State, New York City, or New York local <u>government entity</u> ?	<input type="checkbox"/> Yes <input checked="" type="checkbox"/> No
c) Been <u>suspended</u> , <u>cancelled</u> or <u>terminated for cause</u> (including for <u>non-responsibility</u>) on any <u>federal</u> , New York State, New York City or New York local <u>government contract</u> ?	<input type="checkbox"/> Yes <input checked="" type="checkbox"/> No
d) Been the subject of an <u>investigation</u> , whether open or closed, by any <u>federal</u> , New York State, New York City, or New York local <u>government entity</u> for a civil or criminal violation with a penalty in excess of \$500,000?	<input type="checkbox"/> Yes <input checked="" type="checkbox"/> No
e) Been the subject of an indictment, grant of immunity, <u>judgment</u> , or conviction (including entering into a plea bargain) for conduct constituting a crime?	<input type="checkbox"/> Yes <input checked="" type="checkbox"/> No
f) Been convicted of a criminal offense pursuant to any administrative and/or regulatory action taken by any <u>federal</u> , New York State, New York City, or New York local <u>government entity</u> ?	<input type="checkbox"/> Yes <input checked="" type="checkbox"/> No
g) Initiated or been the subject of any bankruptcy proceedings, whether or not closed, or is any bankruptcy proceeding pending?	<input type="checkbox"/> Yes <input checked="" type="checkbox"/> No
For each "Yes," provide an explanation of the issue(s), identify the <u>Associated Entity's</u> name(s), <u>EIN(s)</u> , primary business activity, relationship to the <u>Reporting Entity</u> , relevant dates, the <u>government entity</u> involved, any remedial or corrective action(s) taken and the current status of the issue(s). Provide answer below or attach additional sheets with numbered responses.	

**NEW YORK STATE
VENDOR RESPONSIBILITY QUESTIONNAIRE
FOR-PROFIT BUSINESS ENTITY**

X. FREEDOM OF INFORMATION LAW (FOIL)	
10. Indicate whether any information supplied herein is believed to be exempt from disclosure under the Freedom of Information Law (FOIL). Note: A determination of whether such information is exempt from FOIL will be made at the time of any request for disclosure under FOIL.	<input type="checkbox"/> Yes <input checked="" type="checkbox"/> No
If "Yes," indicate the question number(s) and explain the basis for the claim.	

XI. AUTHORIZED CONTACT FOR THIS QUESTIONNAIRE		
Name	Telephone	Fax
Robert E. Pickens	972-277-0300 ext.	972-277-0514
Title	Email	
President	bpickens@securustechnologies.com	

New York State VendRep System Vendor Responsibility For-Profit v2 Form

CERTIFICATION:

The undersigned recognizes that this questionnaire is submitted for the express purpose of assisting the State of New York's contracting entities in making a responsibility determination regarding an award of a contract or approval of a subcontract; acknowledges that the State, or its contracting entities, may in its discretion, by means which it may choose, verify the truth and accuracy of all statements made herein; and acknowledges that intentional submission of false or misleading information may constitute a felony under Penal Law Section 175.35 or a misdemeanor under Penal Law Section 175.30 or Section 210.45, and may also be punishable by a fine and/or imprisonment of up to five years under 18 USC Section 1001 and may result in contract termination.

The undersigned certifies that he/she:

- is knowledgeable about the submitting Business Entity's business and operations;
- has read and understands all of the questions contained in the questionnaire;
- has reviewed and/or supplied full and complete responses to each question;
- to the best of their knowledge, information and belief, certifies that the Business Entity's responses are true, accurate and complete, including all attachments, if applicable;
- understands that New York State will rely on the information disclosed in the questionnaire when entering into a contract with the Business Entity; and
- is under obligation to update the information provided herein to include any material changes to the Business Entity's responses at the time of bid/proposal submission through the contract award notification, and may be required to update the information at the request of the state's contracting entities or the Office of the State Comptroller prior to the award and/or approval of a contract, or during the term of the contract.

Reminder:

When filing the vendor responsibility questionnaire online via this System, the Business Entity must indicate in each bid/proposal submitted to a contracting entity that the required questionnaire has been electronically filed.

Also note that the VendRep System Timeliness Standard requires a Business Entity filing a questionnaire via the VendRep System to update and certify their questionnaire within six months prior to the bid/proposal due date or other contracting entity defined due date.

Legal Business Name: OS TEK SOLUTIONS LLC
 Certifier's Name: Tami Whitefield
 Certifier's Title: President
 Certification Date: Dec 19, 2016

Vendor Responsibility For-Profit v2 Form

Status: Certified
Note: The content of any attached documents will not print with this page. To view or print an attached document, you must open it separately by clicking the corresponding hyperlink in the 'Uploaded Files' section of a question.

Basic Vendor Data

Entity Information

Legal Business Entity Name: OS TEK SOLUTIONS LLC
TIN (EIN or SSN): [REDACTED]
Vendor ID: [REDACTED]
Principal Place of Business: PO BOX 1443
Sumner, GA 30024
USA
Telephone: 0787143037
Website: www.gtek.com
Email: admin@gtek.com

Business Entity Information

Business Type: For-Profit
Business Activity: Non-Construction

Authorized Contacts

Name: Terri Whitfield	Title: President	Address: 4485 Tench Road Suite 2421 Sumner, GA 30024-3002 United States
Telephone: (078)714-3037	Fax: (078)714-3037	
Email: admin@gtek.com		
Name: Angela Smith	Title: Administrative Support	Address: 4485 Tench Road Suite 2421 Sumner, GA 30024-3002 United States
Telephone: (078)714-3037	Fax: (078)714-3037	
Email: asg@gtek.com		

I. Legal Business Entity Information

1.0 **Legal Business Entity type -** Check appropriate box and provide additional information:

- Corporation (including PC)
- Limited Liability Company (LLC or PLLC)
- Limited Liability Partnership
- Limited Partnership
- General Partnership
- Sole Proprietor
- Other

Date of Organization

12/23/2008

1.1 Was the Legal Business Entity formed or incorporated in New York State?

- Yes
- No

Indicate jurisdiction when the Legal Business Entity was formed or incorporated:

- USA
- Other

State

Georgia

Attach a Certificate of Good Standing from the applicable jurisdiction or provide an explanation if a Certificate of Good Standing is not available.

Select method for providing this information:

- Enter Below
- Attach Document(s)
- Attach Document(s) with Explanation

Uploaded File

[Cert of Good St. 12.19.16.pdf](#) 135K

1.2 Is the Legal Business Entity publicly traded?

- Yes
- No

1.3 Does the Legal Business Entity have a DUNS Number?

- Yes
- No

Enter DUNS number

008908361

1.4 If the Legal Business Entity's Principal Place of Business is not in New York State, does the Legal Business Entity maintain an office in New York State?

Note: Select "N/A" if Principal Place of Business is in New York State.

- Yes
- No
- N/A

1.5 Is the Legal Business Entity a New York State certified Minority-Owned Business Enterprise (MBE), Women-Owned Business Enterprise (WBE), New York State Small Business (SB), or Federally certified Disadvantaged Business Enterprise (DBE)?

- Yes
- No

Check all that apply

- New York State certified Minority-Owned Business Enterprise (MBE)
- New York State certified Women-Owned Business Enterprise (WBE)
- New York State Small Business (SB)
- Federally certified Disadvantaged Business Enterprise (DBE)

1.6 Identify Officials and Principal Owners, if applicable.

Note: If more than five (5) Officials or Principal Owners need to be listed, select "Attach Document" as the response.

If applicable, reference to relevant SEC filing(s) containing the required information is optional.

Select method for providing this information:

- Enter Below
 Attach Document(s)

Name

Terri Whitfield

Title

President

% of Ownership (Enter 0%, if not applicable)

100

Add another?

- Yes
 No

Last Modified: Dec 19, 2016
 Modified By: Terri Whitfield

II. Reporting Entity Information

2.0 The Reporting Entity for this questionnaire is:

(Note: Select only one)

- Legal Business Entity
 Organizational Unit within and operating under the authority of the Legal Business Entity

Last Modified: Dec 19, 2016
 Modified By: Terri Whitfield

III. Leadership Integrity

Within the past five (5) years, has my current or former Reporting Entity Official or any individual currently or formerly having the authority to sign, execute or approve bids, proposals, contracts or supporting documentation on behalf of the Reporting entity with any government entity been:

3.0 Sanctioned relative to my business or professional permit and/or license?

- Yes
 No
 Other

3.1 Suspended, debarred or disqualified from any government contracting process?

- Yes
 No
 Other

- 3.2 The subject of an investigation, whether open or closed, by any government entity for a civil or criminal violation for any business-related conduct?
- Yes
 No
 Other
- 3.3 Charged with a misdemeanor or felony, indicted, granted immunity, convicted of a crime or subject to a judgment for:
- a. Any business-related activity; or
b. Any crime, whether or not business-related, the underlying conduct of which is related to truthfulness?
- Yes
 No
 Other

Last Modified: Dec 19, 2016
Modified By: Terri Whitfield

IV. Integrity - Contract Bidding

Within the past five (5) years, has the Reporting Entity:

- 4.0 Been suspended or debarred from any government contracting process or been disqualified on any government procurement, permit, license, concession, franchise or lease, including, but not limited to, debarment for a violation of New York State Workers' Compensation or Prevailing Wage laws or New York State Procurement Lobbying Law?
- Yes
 No
- 4.1 Been subject to a denial or revocation of a government prequalification?
- Yes
 No
- 4.2 Been denied a contract award or had a bid rejected based on a non-responsibility finding by a government entity?
- Yes
 No
- 4.3 Had a low bid rejected on a government contract for failure to make good faith efforts on any Minority-Owned Business Enterprise, Women-Owned Business Enterprise or Disadvantaged Business Enterprise goal or statutory affirmative action requirements on a previously held contract?
- Yes
 No
- 4.4 Agreed to a voluntary exclusion from bidding/contracting with a government entity?
- Yes
 No
- 4.5 Initiated a request to withdraw a bid submitted to a government entity in lieu of responding to an information request or subsequent to a formal request to appear before the government entity?
- Yes
 No

Last Modified: Dec 19, 2016
Modified By: Terri Whitfield

V. Integrity - Contract Award

Within the past five (5) years, has the Reporting Entity:

5.0 Been suspended, cancelled or terminated for cause on any government contract including, but not limited to, a non-responsibility finding?

- Yes
 No

5.1 Been subject to an administrative proceeding or civil action seeking specific performance or restitution in connection with any government contract?

- Yes
 No

5.2 Entered into a formal monitoring agreement as a condition of a contract award from a government entity?

- Yes
 No

Last Modified: Dec 19, 2016
 Modified By: Tami Whitefield

VI. Certification/Licenses

Within the past five (5) years, has the Reporting Entity:

6.0 Had a revocation, suspension or disbarment of any business or professional permit and/or license?

- Yes
 No

6.1 Had a denial, decertification, revocation or forfeiture of New York State certification of Minority-Owned Business Enterprise, Women-Owned Business Enterprise or federal certification of Disadvantaged Business Enterprise status for other than a change ownership?

- Yes
 No

Last Modified: Dec 19, 2016
 Modified By: Tami Whitefield

VII. Legal Proceedings

Within the past five (5) years, has the Reporting Entity:

7.0 Been the subject of an investigation, whether open or closed, by any government entity for a civil or criminal violation?

- Yes
 No

7.1 Been the subject of an indictment, grant of immunity, judgment or conviction (including entering into a plea bargain) for conduct constituting a crime?

- Yes
 No

- 7.2 Received any OSHA citation and Notification of Penalty containing a violation classified as serious or willful?
 Yes
 No
- 7.3 Had a government entity find a willful prevailing wage or supplemental payment violation or any other willful violation of New York State Labor Law?
 Yes
 No
- 7.4 Entered into a consent order with the New York State Department of Environmental Conservation, or received an enforcement determination by any government entity involving a violation of federal, state or local environmental laws?
 Yes
 No
- 7.5 Other than the previously disclosed:
 a. Been subject to fines or penalties imposed by government entities which in the aggregate total \$25,000 or more, or
 b. Been convicted of a criminal offense pursuant to any administrative and/or regulatory action taken by any government entity?
 Yes
 No

Last Modified: Dec 19, 2016
 Modified By: Tami Whitfield

VIII. Financial and Organizational Capacity

- 8.0 Within the past five (5) years, has the Reporting Entity received any formal unsatisfactory performance assessment(s) from any government entity on any contract?
 Yes
 No
- 8.1 Within the past five (5) years, has the Reporting Entity had any liquidated damages assessed over \$25,000?
 Yes
 No
- 8.2 Within the past five (5) years, have any fines or judgments (not including UCC filings) over \$25,000 been filed against the Reporting Entity which remain undischarged?
 Yes
 No
- 8.3 In the last seven (7) years, has the Reporting Entity initiated or been the subject of any bankruptcy proceedings, whether or not closed, or is any bankruptcy proceeding pending?
 Yes
 No
- 8.4 During the past three (3) years, has the Reporting Entity failed to file or pay any tax returns required by federal, state or local tax laws?
 Yes
 No

- 8.5 During the past three (3) years, has the Reporting Entity failed to file or pay any New York State unemployment insurance returns?
- Yes
- No

- 8.6 During the past three (3) years, has the Reporting Entity had any government audit(s) completed?
- Yes
- No

Last Modified: Dec 18, 2016
Modified By: Teri Whitfield

IX. Associated Entities

This section pertains to any entity(ies) that either controls or is controlled by the Reporting Entity.

(See definition of "Associated Entity" for additional information to complete this section.)

- 9.0 Does the Reporting Entity have any Associated Entities?

Note: The response must be "Yes," if the Reporting Entity is either:

- An Organizational Unit; or
- The entire Legal Business Entity which controls, or is controlled by, any other entity(ies).

- Yes
- No

Last Modified: Dec 18, 2016
Modified By: Teri Whitfield

X. Freedom of Information Law (FOIL)

- 10.0 Indicate whether any information supplied herein is believed to be exempt from disclosure under the Freedom of Information Law (FOIL).

Note: A determination of whether each information is exempt from FOIL will be made at the time of any request for disclosure under FOIL.

- Yes
- No

Last Modified: Dec 18, 2016
Modified By: Teri Whitfield

Certification

The undersigned: (1) recognizes that this questionnaire is submitted for the express purpose of assisting New York State government entities (including the Office of the State Comptroller (OSC)) in making responsibility determinations regarding award or approval of a contract or subcontract and that each government entity will rely on information disclosed in the questionnaire in making responsibility determinations; (2) acknowledges that the New York State government entities and OSC may, in their discretion, by means which they may choose, verify the truth and accuracy of all statements made herein; and (3) acknowledges that intentional submission of false or misleading information may result in criminal penalties under State and/or Federal Law, as well as a finding of non-responsibility, contract suspension or contract termination.

The undersigned certifies that he/she:

- is knowledgeable about the submitting Business Entity's business and operations;
- has read and understands all of the questions contained in the questionnaire;
- has reviewed and/or supplied fill and complete responses to each question;
- to the best of his/her knowledge, information and belief, certifies that the Business Entity's responses are true, accurate and complete, including all attachments, if applicable;
- understands that New York State government entities will rely on the information disclosed in the questionnaire when entering into a contract with the Business Entity; and
- is under an obligation to update the information provided herein to include any material changes to the Business Entity's response at the time of bid/proposal submission through the contract award notification, and may be required to update the information at the request of the New York State government entities or OSC prior to the award and/or approval of a contract, or during the term of the contract.

1/10/2017

VendRep System - View Certification

Legal Business Name: G5 TEK SOLUTIONS LLC
Certifier's Name: Teri Whitfield
Certifier's Title: President
Certification Date: Dec 19, 2016

[About OSC](#) | [Employment](#) | [Contact Us](#) | [Privacy and Links Policies](#) | [Regulations](#) | [Accessibility](#) | [FOIL](#) | [Webcasts](#)
© Office of the New York State Comptroller

<https://portal.osc.state.ny.us/vendrep/ViewAllSections.html>

8/8

**NEW YORK STATE
VENDOR RESPONSIBILITY QUESTIONNAIRE
FOR-PROFIT BUSINESS ENTITY**

You have selected the For-Profit Non-Construction questionnaire which may be printed and completed in this format or, for your convenience, may be completed online using the New York State VendRep System.

COMPLETION & CERTIFICATION

The person(s) completing the questionnaire must be knowledgeable about the vendor's business and operations. An owner or officer must certify the questionnaire and the signature must be notarized.

NEW YORK STATE VENDOR IDENTIFICATION NUMBER (VENDOR ID)

The Vendor ID is a ten-digit identifier issued by New York State when the vendor is registered on the Statewide Vendor File. This number must now be included on the questionnaire. If the business entity has not obtained a Vendor ID, contact the IT Service Desk at ITServiceDesk@osc.state.ny.us or call 866-370-4672.

DEFINITIONS

All underlined terms are defined in the "New York State Vendor Responsibility Definitions List," found at www.osc.state.ny.us/vendrep/documents/questionnaire/definitions.pdf. These terms may not have their ordinary, common or traditional meanings. Each vendor is strongly encouraged to read the respective definitions for any and all underlined terms. By submitting this questionnaire, the vendor agrees to be bound by the terms as defined in the "New York State Vendor Responsibility Definitions List" existing at the time of certification.

RESPONSES

Every question must be answered. Each response must provide all relevant information which can be obtained within the limits of the law. However, information regarding a determination or finding made in error which was subsequently corrected is not required. Individuals and Sole Proprietors may use a Social Security Number but are encouraged to obtain and use a federal Employer Identification Number (EIN).

REPORTING ENTITY

Each vendor must indicate if the questionnaire is filed on behalf of the entire Legal Business Entity or an Organizational Unit within or operating under the authority of the Legal Business Entity and having the same EIN. Generally, the Organizational Unit option may be appropriate for a vendor that meets the definition of "Reporting Entity" but due to the size and complexity of the Legal Business Entity, is best able to provide the required information for the Organizational Unit, while providing more limited information for other parts of the Legal Business Entity and Associated Entities.

ASSOCIATED ENTITY

An Associated Entity is one that owns or controls the Reporting Entity or any entity owned or controlled by the Reporting Entity. However, the term Associated Entity does **not** include "sibling organizations" (i.e., entities owned or controlled by a parent company that owns or controls the Reporting Entity), unless such sibling entity has a direct relationship with or impact on the Reporting Entity.

STRUCTURE OF THE QUESTIONNAIRE

The questionnaire is organized into eleven sections. Section I is to be completed for the Legal Business Entity. Section II requires the vendor to specify the Reporting Entity for the questionnaire. Section III refers to the individuals of the Reporting Entity, while Sections IV-VIII require information about the Reporting Entity. Section IX pertains to any Associated Entities, with one question about their Officials/Owners. Section X relates to disclosure under the Freedom of Information Law (FOIL). Section XI requires an authorized contact for the questionnaire information.

**NEW YORK STATE
VENDOR RESPONSIBILITY QUESTIONNAIRE
FOR-PROFIT BUSINESS ENTITY**

I. LEGAL BUSINESS ENTITY INFORMATION			
Legal Business Entity Name*		EIN	
PSRI Technologies, LLC		[REDACTED]	
Address of the Principal Place of Business (street, city, state, zip code)		New York State Vendor Identification Number	
113 Eastland Drive		[REDACTED]	
Jefferson City, MO 65101		Telephone	Fax
		573/636-9696 ext. 3103	573-636-5407
Email		Website	
nconley@psritech.com		www.psritech.com	
Additional Legal Business Entity Identities: If applicable, list any other DBA, Trade Name, Former Name, Other Identity, or EIN used in the last five (5) years and the status (active or inactive).			
Type	Name	EIN	Status
1.0 Legal Business Entity Type – Check appropriate box and provide additional information:			
<input type="checkbox"/> Corporation (including PC)		Date of Incorporation	
<input checked="" type="checkbox"/> Limited Liability Company (LLC or PLLC)		Date of Organization 2001	
<input type="checkbox"/> Partnership (including LLP, LP or General)		Date of Registration or Establishment	
<input type="checkbox"/> Sole Proprietor		How many years in business?	
<input type="checkbox"/> Other		Date Established	
If Other, explain:			
1.1 Was the Legal Business Entity formed or incorporated in New York State?			<input type="checkbox"/> Yes <input checked="" type="checkbox"/> No
If "No," indicate jurisdiction where Legal Business Entity was formed or incorporated and attach a Certificate of Good Standing from the applicable jurisdiction or provide an explanation if a Certificate of Good Standing is not available.			
<input checked="" type="checkbox"/> United States State <u>MO</u>			
<input type="checkbox"/> Other Country _____			
Explain, if not available:			
1.2 Is the Legal Business Entity publicly traded?			<input type="checkbox"/> Yes <input checked="" type="checkbox"/> No
If "Yes," provide CIK Code or Ticker Symbol			
1.3 Does the Legal Business Entity have a DUNS Number?			<input checked="" type="checkbox"/> Yes <input type="checkbox"/> No
If "Yes," Enter DUNS Number 614151265			

*All underlined terms are defined in the "New York State Vendor Responsibility Definitions List," which can be found at www.osc.state.ny.us/vendrep/documents/questionnaire/definitions.pdf

**NEW YORK STATE
VENDOR RESPONSIBILITY QUESTIONNAIRE
FOR-PROFIT BUSINESS ENTITY**

I. LEGAL BUSINESS ENTITY INFORMATION		
1.4 If the <u>Legal Business Entity</u> 's <u>Principal Place of Business</u> is not in New York State, does the <u>Legal Business Entity</u> maintain an office in New York State? (Select "N/A," if <u>Principal Place of Business</u> is in New York State.)		<input type="checkbox"/> Yes <input checked="" type="checkbox"/> No <input type="checkbox"/> N/A
If "Yes," provide the address and telephone number for one office located in New York State.		
1.5 Is the <u>Legal Business Entity</u> a New York State certified <u>Minority-Owned Business Enterprise (MBE)</u> , <u>Women-Owned Business Enterprise (WBE)</u> , <u>New York State Small Business (SB)</u> or a federally certified <u>Disadvantaged Business Enterprise (DBE)</u> ? If "Yes," check all that apply:		<input checked="" type="checkbox"/> Yes <input type="checkbox"/> No
<input checked="" type="checkbox"/> New York State certified <u>Minority-Owned Business Enterprise (MBE)</u> <input checked="" type="checkbox"/> New York State certified <u>Women-Owned Business Enterprise (WBE)</u> <input type="checkbox"/> New York State <u>Small Business (SB)</u> <input checked="" type="checkbox"/> Federally certified <u>Disadvantaged Business Enterprise (DBE)</u>		
1.6 Identify <u>Officials</u> and <u>Principal Owners</u> , if applicable. For each person, include name, title and percentage of ownership. Attach additional pages if necessary. If applicable, reference to relevant SEC filing(s) containing the required information is optional.		
Name	Title	Percentage Ownership <i>(Enter 0% if not applicable)</i>
Natasha Conley	President	100%

**NEW YORK STATE
VENDOR RESPONSIBILITY QUESTIONNAIRE
FOR-PROFIT BUSINESS ENTITY**

II. REPORTING ENTITY INFORMATION	
<p>2.0 The <u>Reporting Entity</u> for this questionnaire is:</p> <p>Note: Select only one.</p> <p><input checked="" type="checkbox"/> <u>Legal Business Entity</u></p> <p><i>Note: If selecting this option, "Reporting Entity" refers to the entire <u>Legal Business Entity</u> for the remainder of the questionnaire. (SKIP THE REMAINDER OF SECTION II AND PROCEED WITH SECTION III.)</i></p> <p><input type="checkbox"/> <u>Organizational Unit</u> within and operating under the authority of the <u>Legal Business Entity</u></p> <p>SEE DEFINITIONS OF "<u>REPORTING ENTITY</u>" AND "<u>ORGANIZATIONAL UNIT</u>" FOR ADDITIONAL INFORMATION ON CRITERIA TO QUALIFY FOR THIS SELECTION.</p> <p><i>Note: If selecting this option, "Reporting Entity" refers to the <u>Organizational Unit</u> within the <u>Legal Business Entity</u> for the remainder of the questionnaire. (COMPLETE THE REMAINDER OF SECTION II AND ALL REMAINING SECTIONS OF THIS QUESTIONNAIRE.)</i></p>	
IDENTIFYING INFORMATION	
a) <u>Reporting Entity</u> Name	
Address of the <u>Primary Place of Business</u> (street, city, state, zip code)	Telephone ext.
b) Describe the relationship of the <u>Reporting Entity</u> to the <u>Legal Business Entity</u>	
c) Attach an <u>organizational chart</u>	
d) Does the Reporting Entity have a <u>DUNS</u> Number? <input type="checkbox"/> Yes <input type="checkbox"/> No	
If "Yes," enter <u>DUNS</u> Number	
e) Identify the designated manager(s) responsible for the business of the <u>Reporting Entity</u> . <i>For each person, include name and title. Attach additional pages if necessary.</i>	
Name	Title

**NEW YORK STATE
VENDOR RESPONSIBILITY QUESTIONNAIRE
FOR-PROFIT BUSINESS ENTITY**

INSTRUCTIONS FOR SECTIONS III THROUGH VII

For each "Yes," provide an explanation of the issue(s), relevant dates, the government entity involved, any remedial or corrective action(s) taken and the current status of the issue(s). For each "Other," provide an explanation which provides the basis for not definitively responding "Yes" or "No." Provide the explanation at the end of the section or attach additional sheets with numbered responses, including the Reporting Entity name at the top of any attached pages.

III. LEADERSHIP INTEGRITY	
<i>Within the past five (5) years, has any current or former reporting entity official or any individual currently or formerly having the authority to sign, execute or approve bids, proposals, contracts or supporting documentation on behalf of the reporting entity with any government entity been:</i>	
3.0 <u>Sanctioned</u> relative to any business or professional permit and/or license?	<input type="checkbox"/> Yes <input checked="" type="checkbox"/> No <input type="checkbox"/> Other
3.1 <u>Suspended, debarred, or disqualified</u> from any <u>government contracting process</u> ?	<input type="checkbox"/> Yes <input checked="" type="checkbox"/> No <input type="checkbox"/> Other
3.2 The subject of an <u>investigation</u> , whether open or closed, by any <u>government entity</u> for a civil or criminal violation for any business-related conduct?	<input type="checkbox"/> Yes <input checked="" type="checkbox"/> No <input type="checkbox"/> Other
3.3 Charged with a misdemeanor or felony, indicted, granted immunity, convicted of a crime or subject to a <u>judgment</u> for: a) Any business-related activity; or b) Any crime, whether or not business-related, the underlying conduct of which was related to truthfulness?	<input type="checkbox"/> Yes <input checked="" type="checkbox"/> No <input type="checkbox"/> Other
For each "Yes" or "Other" explain:	

IV. INTEGRITY – CONTRACT BIDDING	
<i>Within the past five (5) years, has the reporting entity:</i>	
4.0 Been <u>suspended</u> or <u>debarred</u> from any <u>government contracting process</u> or been <u>disqualified</u> on any government procurement, permit, license, concession, franchise or lease, including, but not limited to, <u>debarment</u> for a violation of New York State Workers' Compensation or Prevailing Wage laws or New York State Procurement Lobbying Law?	<input type="checkbox"/> Yes <input checked="" type="checkbox"/> No
4.1 Been subject to a denial or revocation of a government prequalification?	<input type="checkbox"/> Yes <input checked="" type="checkbox"/> No
4.2 Been denied a contract award or had a bid rejected based upon a <u>non-responsibility finding</u> by a <u>government entity</u> ?	<input type="checkbox"/> Yes <input checked="" type="checkbox"/> No
4.3 Had a low bid rejected on a <u>government contract</u> for failure to <u>make good faith efforts</u> on any <u>Minority-Owned Business Enterprise</u> , <u>Women-Owned Business Enterprise</u> or <u>Disadvantaged Business Enterprise</u> goal or <u>statutory affirmative action requirements</u> on a previously held contract?	<input type="checkbox"/> Yes <input checked="" type="checkbox"/> No
4.4 Agreed to a voluntary exclusion from bidding/contracting with a <u>government entity</u> ?	<input type="checkbox"/> Yes <input checked="" type="checkbox"/> No
4.5 Initiated a request to withdraw a bid submitted to a <u>government entity</u> in lieu of responding to an information request or subsequent to a formal request to appear before the <u>government entity</u> ?	<input type="checkbox"/> Yes <input checked="" type="checkbox"/> No
For each "Yes," explain:	

**NEW YORK STATE
VENDOR RESPONSIBILITY QUESTIONNAIRE
FOR-PROFIT BUSINESS ENTITY**

V. INTEGRITY – CONTRACT AWARD	
<i>Within the past five (5) years, has the reporting entity:</i>	
5.0 Been <u>suspended</u> , cancelled or <u>terminated for cause</u> on any <u>government contract</u> including, but not limited to, a <u>non-responsibility finding</u> ?	<input type="checkbox"/> Yes <input checked="" type="checkbox"/> No
5.1 Been subject to an <u>administrative proceeding</u> or civil action seeking specific performance or restitution in connection with any <u>government contract</u> ?	<input type="checkbox"/> Yes <input checked="" type="checkbox"/> No
5.2 Entered into a formal monitoring agreement as a condition of a contract award from a <u>government entity</u> ?	<input type="checkbox"/> Yes <input checked="" type="checkbox"/> No
For each "Yes," explain:	

VI. CERTIFICATIONS/LICENSES	
<i>Within the past five (5) years, has the reporting entity:</i>	
6.0 Had a revocation, <u>suspension</u> or <u>disbarment</u> of any business or professional permit and/or license?	<input type="checkbox"/> Yes <input checked="" type="checkbox"/> No
6.1 Had a denial, decertification, revocation or forfeiture of New York State certification of <u>Minority-Owned Business Enterprise</u> , <u>Women-Owned Business Enterprise</u> or federal certification of <u>Disadvantaged Business Enterprise</u> status for other than a change of ownership?	<input type="checkbox"/> Yes <input checked="" type="checkbox"/> No
For each "Yes," explain:	

VII. LEGAL PROCEEDINGS	
<i>Within the past five (5) years, has the reporting entity:</i>	
7.0 Been the subject of an <u>investigation</u> , whether open or closed, by any <u>government entity</u> for a civil or criminal violation?	<input type="checkbox"/> Yes <input checked="" type="checkbox"/> No
7.1 Been the subject of an indictment, grant of immunity, <u>judgment</u> or conviction (including entering into a plea bargain) for conduct constituting a crime?	<input type="checkbox"/> Yes <input checked="" type="checkbox"/> No
7.2 Received any OSHA citation and Notification of Penalty containing a violation classified as <u>serious</u> or <u>willful</u> ?	<input type="checkbox"/> Yes <input checked="" type="checkbox"/> No
7.3 Had a <u>government entity</u> find a willful prevailing wage or supplemental payment violation or any other willful violation of New York State Labor Law?	<input type="checkbox"/> Yes <input checked="" type="checkbox"/> No
7.4 Entered into a consent order with the New York State Department of Environmental Conservation, or received an enforcement determination by any <u>government entity</u> involving a violation of federal, state or local environmental laws?	<input type="checkbox"/> Yes <input checked="" type="checkbox"/> No
7.5 Other than previously disclosed: a) Been subject to fines or penalties imposed by <u>government entities</u> which in the aggregate total \$25,000 or more; or b) Been convicted of a criminal offense pursuant to any administrative and/or regulatory action taken by any <u>government entity</u> ?	<input type="checkbox"/> Yes <input checked="" type="checkbox"/> No
For each "Yes," explain:	

**NEW YORK STATE
VENDOR RESPONSIBILITY QUESTIONNAIRE
FOR-PROFIT BUSINESS ENTITY**

VIII. FINANCIAL AND ORGANIZATIONAL CAPACITY	
8.0 Within the past five (5) years, has the <u>Reporting Entity</u> received any <u>formal unsatisfactory performance assessment(s)</u> from any <u>government entity</u> on any contract?	<input type="checkbox"/> Yes <input checked="" type="checkbox"/> No
If "Yes," provide an explanation of the issue(s), relevant dates, the <u>government entity</u> involved, any remedial or corrective action(s) taken and the current status of the issue(s). Provide answer below or attach additional sheets with numbered responses.	
8.1 Within the past five (5) years, has the <u>Reporting Entity</u> had any <u>liquidated damages</u> assessed over \$25,000?	<input type="checkbox"/> Yes <input checked="" type="checkbox"/> No
If "Yes," provide an explanation of the issue(s), relevant dates, contracting party involved, the amount assessed and the current status of the issue(s). Provide answer below or attach additional sheets with numbered responses.	
8.2 Within the past five (5) years, have any <u>liens</u> or <u>judgments</u> (not including UCC filings) over \$25,000 been filed against the <u>Reporting Entity</u> which remain undischarged?	<input type="checkbox"/> Yes <input checked="" type="checkbox"/> No
If "Yes," provide an explanation of the issue(s), relevant dates, the Lien holder or Claimant's name(s), the amount of the <u>lien(s)</u> and the current status of the issue(s). Provide answer below or attach additional sheets with numbered responses.	
8.3 In the last seven (7) years, has the <u>Reporting Entity</u> initiated or been the subject of any bankruptcy proceedings, whether or not closed, or is any bankruptcy proceeding pending?	<input type="checkbox"/> Yes <input checked="" type="checkbox"/> No
If "Yes," provide the bankruptcy chapter number, the court name and the docket number. Indicate the current status of the proceedings as "Initiated," "Pending" or "Closed." Provide answer below or attach additional sheets with numbered responses.	
8.4 During the past three (3) years, has the <u>Reporting Entity</u> failed to file or pay any tax returns required by <u>federal</u> , state or local tax laws?	<input type="checkbox"/> Yes <input checked="" type="checkbox"/> No
If "Yes," provide the taxing jurisdiction, the type of tax, the liability year(s), the tax liability amount the <u>Reporting Entity</u> failed to file/pay and the current status of the tax liability. Provide answer below or attach additional sheets with numbered responses.	
8.5 During the past three (3) years, has the <u>Reporting Entity</u> failed to file or pay any New York State unemployment insurance returns?	<input type="checkbox"/> Yes <input checked="" type="checkbox"/> No
If "Yes," provide the years the <u>Reporting Entity</u> failed to file/pay the insurance, explain the situation and any remedial or corrective action(s) taken and the current status of the issue(s). Provide answer below or attach additional sheets with numbered responses.	
8.6 During the past three (3) years, has the <u>Reporting Entity</u> had any <u>government audit(s)</u> completed?	<input type="checkbox"/> Yes <input checked="" type="checkbox"/> No
a) If "Yes," did any audit of the <u>Reporting Entity</u> identify any reported significant deficiencies in internal control, fraud, illegal acts, significant violations of provisions of contract or grant agreements, significant abuse or any <u>material disallowance</u> ?	<input type="checkbox"/> Yes <input checked="" type="checkbox"/> No
If "Yes" to 8.6 a), provide an explanation of the issue(s), relevant dates, the <u>government entity</u> involved, any remedial or corrective action(s) taken and the current status of the issue(s). Provide answer below or attach additional sheets with numbered responses.	

**NEW YORK STATE
VENDOR RESPONSIBILITY QUESTIONNAIRE
FOR-PROFIT BUSINESS ENTITY**

IX. ASSOCIATED ENTITIES <i>This section pertains to any entity(ies) that either controls or is controlled by the reporting entity. (See definition of "associated entity" for additional information to complete this section.)</i>	
9.0 Does the <u>Reporting Entity</u> have any <u>Associated Entities</u> ? Note: All questions in this section must be answered if the <u>Reporting Entity</u> is either: - An <u>Organizational Unit</u> ; or - The entire <u>Legal Business Entity</u> which controls, or is controlled by, any other entity(ies). If "No," SKIP THE REMAINDER OF SECTION IX AND PROCEED WITH SECTION X.	<input type="checkbox"/> Yes <input checked="" type="checkbox"/> No
9.1 Within the past five (5) years, has any <u>Associated Entity Official</u> or <u>Principal Owner</u> been charged with a misdemeanor or felony, indicted, granted immunity, convicted of a crime or subject to a <u>judgment</u> for: a) Any business-related activity; or b) Any crime, whether or not business-related, the underlying conduct of which was related to truthfulness?	<input type="checkbox"/> Yes <input type="checkbox"/> No
If "Yes," provide an explanation of the issue(s), the individual involved, his/her title and role in the <u>Associated Entity</u> , his/her relationship to the <u>Reporting Entity</u> , relevant dates, the <u>government entity</u> involved, any remedial or corrective action(s) taken and the current status of the issue(s).	
9.2 Does any <u>Associated Entity</u> have any currently undischarged <u>federal</u> , New York State, New York City or New York local government <u>liens</u> or <u>judgments</u> (not including UCC filings) over \$50,000?	<input type="checkbox"/> Yes <input type="checkbox"/> No
If "Yes," provide an explanation of the issue(s), identify the <u>Associated Entity's</u> name(s), <u>EIN(s)</u> , primary business activity, relationship to the <u>Reporting Entity</u> , relevant dates, the Lien holder or Claimant's name(s), the amount of the <u>lien(s)</u> and the current status of the issue(s). Provide answer below or attach additional sheets with numbered responses.	
9.3 Within the past five (5) years, has any <u>Associated Entity</u> :	
a) Been <u>disqualified</u> , <u>suspended</u> or <u>debarred</u> from any <u>federal</u> , New York State, New York City or other New York local <u>government contracting process</u> ?	<input type="checkbox"/> Yes <input type="checkbox"/> No
b) Been denied a contract award or had a bid rejected based upon a <u>non-responsibility finding</u> by any <u>federal</u> , New York State, New York City, or New York local <u>government entity</u> ?	<input type="checkbox"/> Yes <input type="checkbox"/> No
c) Been <u>suspended</u> , <u>cancelled</u> or <u>terminated for cause</u> (including for <u>non-responsibility</u>) on any <u>federal</u> , New York State, New York City or New York local <u>government contract</u> ?	<input type="checkbox"/> Yes <input type="checkbox"/> No
d) Been the subject of an <u>investigation</u> , whether open or closed, by any <u>federal</u> , New York State, New York City, or New York local <u>government entity</u> for a civil or criminal violation with a penalty in excess of \$500,000?	<input type="checkbox"/> Yes <input type="checkbox"/> No
e) Been the subject of an indictment, grant of immunity, <u>judgment</u> , or conviction (including entering into a plea bargain) for conduct constituting a crime?	<input type="checkbox"/> Yes <input type="checkbox"/> No
f) Been convicted of a criminal offense pursuant to any administrative and/or regulatory action taken by any <u>federal</u> , New York State, New York City, or New York local <u>government entity</u> ?	<input type="checkbox"/> Yes <input type="checkbox"/> No
g) Initiated or been the subject of any bankruptcy proceedings, whether or not closed, or is any bankruptcy proceeding pending?	<input type="checkbox"/> Yes <input type="checkbox"/> No
For each "Yes," provide an explanation of the issue(s), identify the <u>Associated Entity's</u> name(s), <u>EIN(s)</u> , primary business activity, relationship to the <u>Reporting Entity</u> , relevant dates, the <u>government entity</u> involved, any remedial or corrective action(s) taken and the current status of the issue(s). Provide answer below or attach additional sheets with numbered responses.	

**NEW YORK STATE
VENDOR RESPONSIBILITY QUESTIONNAIRE
FOR-PROFIT BUSINESS ENTITY**

X. FREEDOM OF INFORMATION LAW (FOIL)	
10. Indicate whether any information supplied herein is believed to be exempt from disclosure under the Freedom of Information Law (FOIL). Note: A determination of whether such information is exempt from FOIL will be made at the time of any request for disclosure under FOIL.	<input type="checkbox"/> Yes <input checked="" type="checkbox"/> No
If "Yes," indicate the question number(s) and explain the basis for the claim.	

XI. AUTHORIZED CONTACT FOR THIS QUESTIONNAIRE		
Name Natasha Conley	Telephone 573-636-9696 ext. 3103	Fax 573-636-5407
Title President	Email Nconley@psritech.com	

**NEW YORK STATE
VENDOR RESPONSIBILITY QUESTIONNAIRE
FOR-PROFIT BUSINESS ENTITY**

Certification

The undersigned: (1) recognizes that this questionnaire is submitted for the express purpose of assisting New York State government entities (including the Office of the State Comptroller (OSC)) in making responsibility determinations regarding award or approval of a contract or subcontract and that such government entities will rely on information disclosed in the questionnaire in making responsibility determinations; (2) acknowledges that the New York State government entities and OSC may, in their discretion, by means which they may choose, verify the truth and accuracy of all statements made herein; and (3) acknowledges that intentional submission of false or misleading information may result in criminal penalties under State and/or Federal Law, as well as a finding of non-responsibility, contract suspension or contract termination.

The undersigned certifies that he/she:

- is knowledgeable about the submitting Business Entity's business and operations;
- has read and understands all of the questions contained in the questionnaire;
- has not altered the content of the questionnaire in any manner;
- has reviewed and/or supplied full and complete responses to each question;
- to the best of his/her knowledge, information and belief, confirms that the Business Entity's responses are true, accurate and complete, including all attachments, if applicable;
- understands that New York State government entities will rely on the information disclosed in the questionnaire when entering into a contract with the Business Entity; and
- is under an obligation to update the information provided herein to include any material changes to the Business Entity's responses at the time of bid/proposal submission through the contract award notification, and may be required to update the information at the request of the New York State government entities or OSC prior to the award and/or approval of a contract, or during the term of the contract.

Signature of Owner/Officer: 
 Printed Name of Signatory: Natasha Cunley
 Title: President
 Name of Business: FSRI Technologies, LLC
 Address: 113 Eastland Drive
 City, State, Zip: Jefferson City, MO 65101

Sworn to before me this 11 day of January, 2017;

 Notary Public



Completed Forms

M/WBE and EEO Requirements (Appendix C)

**MINORITY AND WOMEN-OWNED BUSINESS ENTERPRISES
EQUAL EMPLOYMENT OPPORTUNITY POLICY STATEMENT**

M/WBE AND EEO POLICY STATEMENT

I, Robert E. Pickens, the President (title) of Securus Technologies (Contractor) agree that Securus Technologies, Inc. (Contractor) has adopted the following policies with respect to Contract Number RFP 2016-02.

M/WBE

Contractor will make good faith efforts to achieve the M/WBE contract participation goals set by DDCCS for that area in which the State-funded project is located by taking the following steps:

- A. Actively and affirmatively solicit bids for contracts and subcontracts from qualified State certified MBEs or WBEs, including solicitations to M/WBE contractor associations.
- B. Request a list of State-certified M/WBEs from DDCCS and solicit bids from them directly.
- C. Ensure that plans, specifications, request for proposals, and other documents used to secure bids will be made available in sufficient time for review by prospective M/WBEs.
- D. Where feasible, divide the work into smaller portions to enhance participation by M/WBEs. Encourage the formation of joint venture and other partnerships among M/WBE contractors to enhance their participation.
- E. Document and maintain records of bid solicitation, including those to M/WBEs and the results thereof. Contractor will also maintain records of actions that its Subcontractors have taken toward meeting M/WBE contract participation goals.
- F. Ensure that progress payments to M/WBEs are made on a timely basis so that undue financial hardship is avoided, and that bonding and other credit requirements are waived or appropriate alternatives developed to encourage M/WBE participation.

EEO

- A. Contractor will not discriminate against any employee or applicant for employment because of race, creed, color, national origin, sex, age, disability or marital status, will undertake or continue existing programs of affirmative action to ensure that minority group members are afforded equal employment opportunities without discrimination, and shall make and document its conscientious and active efforts to employ and utilize minority group members and women in its work force on state contracts.
- B. This organization shall state in all solicitation or advertisements for employees that in the performance of the State contract all qualified applicants will be afforded equal employment opportunities without discrimination because of race, creed, color, national origin, sex, disability or marital status.

At the request of the contracting agency, this organization shall request each employment agency, labor union, or authorized representative will not discriminate on the basis of race, creed, color, national origin, sex, age, disability or marital status and that such union or representative will affirmatively cooperate in the implementation of this organization's obligations herein.

- D. Contractor shall comply with the provisions of the Human Rights Law, all other State and Federal statutory and constitutional non-discrimination provisions. Contractor and Subcontractors shall not discriminate against any employee or applicant for employment because of race, creed (religion), color, sex, national origin, sexual orientation, military status, age, disability, predisposing genetic characteristic, marital status or domestic violence victim status, and shall also follow the requirements of the Human Rights Law with regard to non-discrimination on the basis of prior criminal conviction and prior arrest.
- E. This organization will include the provisions of sections (a) through (d) of this agreement in every subcontract in such a manner that the requirements of the subdivisions will be binding upon each Subcontractor as to work in connection with the State contract.

Agreed to this 19 day of January, 2017

By: 

Print: Robert E. Pickens Title: President

John Bell, Senior Vice President, Sales is designated as the Minority Business
(Name of Designated Liaison)

Enterprise Liaison responsible for administering the Minority and Women-Owned
Business Enterprises- Equal Employment Opportunity (M/WBE-EEO) program.

M/WBE Contract Goals

No less than 30% Minority and Women-Owned Business Enterprise Participation.

15 % Minority-Owned Business Enterprise Participation

15 % Women-Owned Business Enterprise Participation

EEO Contract Goals

 % Minority Labor Force Participation

 % Female Labor Force Participation



(Authorized Representative)

Title: President

Date: 1/19/2017

Securus Technologies, Inc.

G5 Tek Solutions, LLC

(M/WBE Form 100-G Utilization Plan Details)

As a WBE subcontractor to Securus, G5 Tek Solutions will provide Securus with the following services for DOCCS:

3. Detailed Description of Work/Purchase	4. Dollar Value of Subcontracts/Supplies/Services and intended performance dates of each component of the contract.
<p>G5 will hire, train and manage ten (10) qualified site technicians to perform preventative maintenance, trouble service calls and other on-site services to DOCCS sites. Four (4) of the ten (10) technicians will be certified to maintain and troubleshoot Wi-Fi networks to support the tablet program.</p> <p>Each technician will cover multiple DOCCS sites in geographical proximity to meet contractual Service Level Agreement response and restore times.</p>	<p>Labor quoted at \$912,000 annually. Estimated annual mileage is \$260,000. Total estimated expenditures \$1,172,000 annually.</p>
<p>G5 will hire, train and manage two tablet administrators to provide logistical and technical support for DOCCS. Light travel anticipated for on-site assistance at 25% of the Technician miles.</p>	<p>Labor quoted at \$149,000 annually. Estimated annual mileage is \$13,000. Total estimated expenditures \$162,000 annually.</p>
<p>G5 will provide 15 Site Administrators to perform administrative or technical operation and procedures, including: data compilation of reports from the inmate telephone system (ITS), analysis reporting requirements, maintaining working knowledge of the inmate telephone system (ITS), report generation of standard and custom reports, trouble report management, tracking and resolution, training methods and audit methodologies. Coordinates with customer, management and other organization groups to resolve technical and administrative issues.</p>	<p>Labor quoted at \$1,116,000 annually.</p>

G5 may provide the following services as part of the implementation or during the contract term:	
G5 may supply initial materials, equipment and services as required to implement the DOCCS system such as phones, MDF/IDF equipment, routers, workstations, etc.	Project expenditures estimated at \$1,007,000.
G5 may supply two teams of qualified electricians/technicians to provide on-site assistance to Securus for the term of the implementation project. These teams may perform site preparation, phone installation, network installation and platform system installation.	Labor, mileage, and per diems expenditures estimated at \$687,000.

Securus Technologies, Inc.

Securus Technologies, Inc.

PSRI Technologies, Inc

(M/WBE Form 100-G Utilization Plan Details)

As a WBE subcontractor to Securus, PSRI Technologies will provide Securus with the following services for DOCCS:

3. Detailed Description of Work/Purchase	4. Dollar Value of Subcontracts/Supplies/Services and intended performance dates of each component of the contract.
<p>Under the supervision of the Securus Investigative Support team, PSRI will:</p> <p style="padding-left: 40px;">Hire, train and manage up to eighty (80) qualified Communication Analysts to monitor inmate phone calls for DOCCS.</p> <p style="padding-left: 40px;">Hire, train and manage one (1) First/Mid-level Manager and one (1) Administrative Support Worker to manage the Communication Analyst staff</p> <p style="padding-left: 40px;">Hire, train and manage up to 5 qualified investigative staff personnel to perform intelligent investigations, real-time analysis on call data and provide Suspicious Activity Reports on call volume pattern, call volumes and other needs as required by DOCCS.</p>	<p>Labor quoted at \$2,402,000 annually.</p>
<p>PSRI may provide the following services as part of the implementation or during the contract term:</p>	
<p>PSRI may supply initial materials, equipment and services as required to implement the DOCCS system such as workstations, ancillary equipment, etc.</p>	<p>Project expenditures estimated at up to \$1,000,000.</p>

Securus Technologies, Inc.

Securus Technologies, Inc.

Completed Forms

Encouraging NYS Business Form

ENCOURAGING USE OF NEW YORK STATE BUSINESSES IN CONTRACT PERFORMANCE

New York State businesses have a substantial presence in State Contracts and strongly contribute to the economies of the state and the nation. In recognition of their economic activity and leadership in doing business in New York State, Bidders for this contract for commodities, services or technology are strongly encouraged and expected to consider New York State businesses in the fulfillment of the requirements of the Contract. Such partnering may be as subcontractors, suppliers, protégés or other supporting roles. Bidders need to be aware that all authorized users of this Contract will be strongly encouraged, to the maximum extent practical and consistent with legal requirements, to use responsible and responsive New York State businesses in purchasing commodities that are of equal quality and functionality and in utilizing services and technology. Furthermore, Bidders are reminded that they must continue to utilize small, minority and women-owned businesses, consistent with current State law.

Utilizing New York State businesses in State Contracts will help create more private sector jobs, rebuild New York's infrastructure, and maximize economic activity to the mutual benefit of the Contractor and its New York State business partners. New York State businesses will promote the Contractor's optimal performance under the Contract, thereby fully benefiting the public sector programs that are supported by associated procurements.

Public procurements can drive and improve the State's economic engine through promotion of the use of New York businesses by its Contractors. The State, therefore, expects Bidders to provide maximum assistance to New York businesses in their use of the Contract. The potential participation by all kinds of New York businesses will deliver great value to the State and its taxpayers.

Bidders can demonstrate their commitment to the use of New York State businesses by responding to the question below:

Will New York State Businesses be used in the performance of this Contract? _____
Yes No

If yes, identify New York State Business(es) that will be used; (Attach identifying information).

Completed Forms

Vendor Reference Form (Appendix F)

Appendix F Vendor Reference Form

Vendor Reference Form

Complete a separate set of forms for the prime contractor and for each proposed subcontractor. Bidders and subcontractors should inform references in advance that DOCCS will be contacting them regarding the reference.

Prime Contractor Name: Securus Technologies

Subcontractor Name (if applicable): NA

Complete a separate form for each of three (3) references

Reference Information

Reference organization name: Connecticut Department of Correction

Address: 24 Wolcott Hill Rd

City: Wethersfield

State, zip code: CT 06109

Contact person:

Name: Domenick Pisano

Title/position: Lieutenant - CT DOC Security Division

Phone number: 860 692-7531

Email: Domenickj.pisano@ct.gov

Services/systems bidder provided: SCP, THREADS, ICER

Initial Installation date: 6/12/2012

System currently installed (model/release; indicate if same as proposed to DOCCS)

SCP 11.2 – this is the same system as proposed to DOCCS

Number of locations/facilities: 20

Number phones: 1,330

Number inmates served: 16,000

Number of users: 255

Number of called party accounts: 44,984

Vendor Reference Form

Percentage of billings by type:

Collect:	0%
Pre-paid:	99.5%
International:	>1%

Performance statistics for past 12 months:

System availability:	99.92%
Network availability:	100%
Mean time to repair (MTTR) premise equipment:	55 hours
Number of system problems reported:	762
Mean time to resolve by priority level	
Priority 1:	21 hours
Priority 2:	38 hours
Priority 3:	58 hours

Customer service performance for the last 12 months:

Average hold time:	10.91 seconds
Per cent of hang ups/dropped calls:	1.32%
Number of complaints:	0.0021%
Mean resolution time:	77.41%

Inmate calls performance for the last 12 months

Availability:	100%
Percent of drops and disconnects:	Est. <2%
Number of complaints:	9

*Securus is, by far, the industry leader in the number of facilities and customers served. We process more than a million inmate calls daily. In this context, our number of complaints is very, very low.

Vendor Reference Form

Complete a separate set of forms for the prime contractor and for each proposed subcontractor. Bidders and subcontractors should inform references in advance that DOCCS will be contacting them regarding the reference.

Prime Contractor Name: Securus Technologies, Inc.
 Subcontractor Name (if applicable): NA

Complete a separate form for each of three (3) references

Reference Information

Reference organization name: Illinois Department of Corrections
 Address: 1301 Concordia Court
 City: Springfield
 State, zip code: Illinois 62794

Contact person:

Name: Mike Mitchell
 Title/position: Telecom Manager
 Phone number: Ofc: 217-558-2202 / C: 217-306-5298
 Email: Michael.d.mitchell@doc.illinois.gov

Services/systems bidder provided: SCP, THREADS, ICER

Initial Installation date: August 30, 2012

System currently installed (model/release; indicate if same as proposed to DOCCS)

SCP 11.2 – this is the same system as proposed to DOCCS

Number of locations/facilities: 39
 Number phones: 2,948
 Number inmates served: 50,235
 Number of users: 513
 Number of called party accounts: 87,621

Vendor Reference Form

Percentage of billings by type:

Collect:	1.3%
Pre-paid:	98.7%
International:	>1%

Performance statistics for past 12 months:

System availability:	99.992%
Network availability:	100%
Mean time to repair (MTTR) premise equipment:	55 hours
Number of system problems reported:	922
Mean time to resolve by priority level	
Priority 1:	21 hours
Priority 2:	38 hours
Priority 3:	58 hours

Customer service performance for the last 12 months:

Average hold time:	10.91 seconds
Per cent of hang ups/dropped calls:	1.32%
Number of complaints:	0.0021%
Mean resolution time:	77.41%

Inmate calls performance for the last 12 months

Availability:	99.99999%
Percent of drops and disconnects:	Est. < 2%
Number of complaints:	9+

*Securus is, by far, the industry leader in the number of facilities and customers served. We process more than a million inmate calls daily. In this context, our number of complaints is very, very low.

Vendor Reference Form

Complete a separate set of forms for the prime contractor and for each proposed subcontractor. Bidders and subcontractors should inform references in advance that DOCCS will be contacting them regarding the reference.

Prime Contractor Name: Securus Technologies, Inc.
 Subcontractor Name (if applicable): NA

Complete a separate form for each of three (3) references

Reference Information

Reference organization name: Pennsylvania Department of Correction
 Address: 1920 Technology Parkway
 City: Mechanicsburg
 State, zip code: Pennsylvania, 17050

Contact person:

Name: John Rivello
 Title/position: Major / Office of Special Investigations and Intelligence
 Phone number: 717-728-2025
 Email: Jrivello@pa.gov

Services/systems bidder provided: Inmate Telephones

Initial Installation date: January 12, 2015

System currently installed (model/release; indicate if same as proposed to DOCCS)

SCP 11.2 – this is the same system as proposed to DOCCS

Number of locations/facilities: 28
 Number phones: 2,657
 Number inmates served: 52,589
 Number of users: 890
 Number of called party accounts: 40,621

Vendor Reference Form

Percentage of billings by type:

Collect:	57%
Pre-paid:	43%
International:	3%

Performance statistics for past 12 months:

System availability:	99.92%
Network availability:	100%
Mean time to repair (MTTR) premise equipment:	55 hours
Number of system problems reported:	1,273
Mean time to resolve by priority level	

Priority 1:	21 hours
Priority 2:	38 hours
Priority 3:	58 hours

Customer service performance for the last 12 months:

Average hold time:	10.91 seconds
Per cent of hang ups/dropped calls:	1.32%
Number of complaints:	0.0021%
Mean resolution time:	77.41%

Inmate calls performance for the last 12 months

Availability:	99.99999%
Percent of drops and disconnects:	Est. <2%
Number of complaints:	9

*Securus is, by far, the industry leader in the number of facilities and customers served. We process more than a million inmate calls daily. In this context, our number of complaints is very, very low.

Completed Forms

Staff Qualification Form (Appendix G)

Complete a separate form for each proposed staff person and attach full résumé.

Vendor Name: _____

Name of Proposed Staff: **Adam Mercer**

Position and Title: **Primary Contact – Advisory Account Executive, Sales - DO**

Name of Firm: **Securus Technologies, Inc.**

Telephone Number: **904-613-8477**

Role in This Contract: **Primary Contact/Account Manager**

Years of Experience - Total: **16**

Years of Experience - With Current Firm: **6**

Education (Degree(s) and Specialization): _____

Bachelor of Science - Computer Information Systems, Microsoft Certified

References

Complete a separate form for each of three (3) references

Relevant Project: Arkansas Department of Corrections – Inmate Telephone System
Relevancy to DOCCS Requirements: Customer Service and Project Management of DOC-Inmate Telephone
Reference Organization Name: Arkansas Department of Community Corrections (ACC)
Address: 105 W. Capitol Avenue
City, State, Zip Code: Little Rock, AR 72201
Contact Name: Sheila Sharp
Title/Position: Director, Community Corrections
Phone Number: 501-682-9566
Email: Sheila.Sharp@arkansas.gov
Specific Role: Sales, Project Implementation Coordinator, Post-Sales Support
Dates of relevant experience: February 2015 – March 2016
Brief Description (Brief scope, size, cost etc.):
Facilities: 26
Inmates: 17,271
Implementation Timeline: 120 days
Products, Features and Capabilities: Secure Call Platform (SCP), THREADS, Investigator Pro, Securus Video Visitation (SVV)
Narrative: The project included the install of approximately 26 facilities in approximately 120 days. This included both DOC and Community Corrections facilities. Mr. Mercer worked alongside Mr. Michael Kenyon to facilitate the implementation with the Securus Project Management team. The project was handled in three phases: SCP, then Investigative features and finally Video Visitation. Securus worked with the ADC project team and was responsive to various augmentations to the project scope in the midst of the implementation process.

Appendix G

References

Complete a separate form for each of three (3) references

Relevant Project: Arkansas Department of Corrections – Inmate Telephone System
Relevancy to DOCCS Requirements: Customer Service and Project Management of DOC-Inmate Telephone
Reference Organization Name: Arkansas Department of Corrections (ADC)
Address: P.O. Box 8707
City, State, Zip Code: Pine Bluff, AR 71611
Contact Name: Raymond Naylor
Title/Position: Internal Affairs Div. /Disciplinary Hearing Administrator
Phone Number: 870-718-5248
Email: Raymond.Naylor@arkansas.gov
Specific Role: Sales, Project Implementation Coordinator, Post-Sales Support
Dates of relevant experience: February 2015 – March 2016
Brief Description (Brief scope, size, cost etc.):

Facilities: 26

Inmates: 17,271

Implementation Timeline: 120 days

Products, Features and Capabilities: Secure Call Platform (SCP), THREADS, Investigator Pro, Securus Video Visitation (SVV)

Narrative: The project included the install of approximately 26 facilities in approximately 120 days. This included both DOC and Community Corrections facilities. Mr. Mercer worked alongside Mr. Michael Kenyon to facilitate the implementation with the Securus Project Management team. The project was handled in three phases: SCP, then Investigative features and finally Video Visitation. Securus worked with the ADC project team and was responsive to various augmentations to the project scope in the midst of the implementation process.

Appendix G

References

Complete a separate form for each of three (3) references

Relevant Project: Connecticut Department of Corrections – Inmate Telephone System
Relevancy to DOCCS Requirements: Customer Service and Project Management of DOC-Inmate Telephone
Reference Organization Name: Connecticut Department of Corrections (CT DOC)
Address: 24 Wolcott Hill Road
City, State, Zip Code: Wethersfield, CT 06109
Contact Name: Lt. Domenick Pisano
Title/Position: Lieutenant, Intelligence Division
Phone Number: 860-692-7531
Email: Domenickj.Pisano@ct.gov
Specific Role: Sales, Project Implementation Coordinator, Post-Sales Support
Dates of relevant experience: March 2012 – June 2013
Brief Description (Brief scope, size, cost etc.):

Facilities: 20

Inmates: 17,000

Implementation Timeline: 90 days

Cutover Timeline: 2 days

Products, Features and Capabilities: Secure Call Platform (SCP), THREADS

Narrative: The CT DOC project included the install of approximately 20 facilities in approximately 90 days. All aspects of the project were negotiated, planned, organized and implemented at the direction and with the authorization of CT DOC Administration and staff. This included the proposed SCP inmate telephone system as well as the THREADS data analytics capability. The transition was managed by Mr. Mercer and the Securus Project Management team. The proactive approach taken to pre-wire the networking and queue up applications put Securus in position such that all 20 CT Facilities and the CT DOC Central Office were cutover to the Securus system in two days with zero issues impacting the transfer of service. It was truly a seamless cutover and installation.

Appendix G



Adam Mercer

Advisory Account Executive – Sales DOC

Adam has been with in the Corrections Communications industry for more than 16 years. As a DOC Account Executive, he is responsible for new business relationships. Adam works closely with DOC team members to coordinate new business growth, cultivate existing business relationships, and streamline communications to our customers. He has dedicated the last 16 years of his career to serving the technology needs of law enforcement and corrections agencies across the country.

Experience

- Sales and Account Management responsibilities for State Department of Corrections and “Mega” County/Local accounts located in the Eastern Region of the United States
 - Attends represents company at local and national trade shows and conferences
 - Performs interdepartmental communications relative to implementation and development of proposal and marketing information. Remote daily employee management
 - Managed sales team responsible for Southeast Region encompassing seven states including management of budgets, sales goals, quotas, RFP/RFIs and CRM data management
 - Performed new sales and existing customer relationship management throughout the Southeastern United States
 - Handled all rebids of existing customers, was responsible for prospecting for new accounts in territory
 - Interfaced with implementation and development groups on behalf of internal and external customers to further the product features and functions offered
 - Performed industry trend analysis to further growth and portfolio maintenance
 - Managed 20+ accounts totaling more than \$25 million in annual revenue while maintaining multi-million dollar new sales quotas annually
-

Training/Certifications

- Huthwaite SPIN Sales Training
- Bay Group Negotiation Training
- Presenting What Matters Advanced Presentation Training
- CISCO Routing and Networking
- Microsoft SQL Server System Administration
- Microsoft SQL Server Implementation

- Microsoft Network Administration
 - Microsoft Windows Administration Certification
-

Education

- University of Mobile – Mobile, Alabama
Bachelor of Science – Computer Information Systems

Complete a separate form for each proposed staff person and attach full résumé.

Vendor Name: _____

Name of Proposed Staff: **Amy Hewitt** _____

Position and Title: **Director – Account Management** _____

Name of Firm: **Securus Technologies, Inc.** _____

Telephone Number: **214-310-3683** _____

Role in This Contract: **Account Management Support** _____

Years of Experience - Total: **17** _____

Years of Experience - With Current Firm: **17** _____

Education (Degree(s) and Specialization): _____

University of North Texas

References

Complete a separate form for each of three (3) references

Relevant Project:	Illinois Department of Corrections
Relevancy to DOCCS Requirements:	ITS provider / Investigative services
Reference Organization Name:	IL DOC
Address:	1301 Concordia
City, State, Zip Code:	Springfield IL 62794
Contact Name:	Mike Mitchell
Title/Position:	Telecom Contract Manager
Phone Number:	217-558-2202
Email:	Michael.D.Mitchell@doc.illinois.gov
Specific Role:	Program Manager / Senior Account Manager
Dates of relevant experience:	June 2012 to present
Brief Description (Brief scope, size, cost etc.):	
	45 facilities,
	2,477 phones,
	Inmate ADP – 49,643 –
	SCP, ICER, Threads, 3-Way Call Detection, Covert Alert, Crime Tip

Appendix G

References

Complete a separate form for each of three (3) references

Relevant Project:	Louisiana Department of Corrections
Relevancy to DOCCS Requirements:	ITS provider / Investigative services
Reference Organization Name:	LA DOC
Address:	504 Mayflower
City, State, Zip Code:	Baton Rouge, LA 70802
Contact Name:	Dawson Andrews
Title/Position:	Director IT
Phone Number:	225-342-8782
Email:	dawson.andrews@doc.la.gov
Specific Role:	Program Manager / Senior Account Manager
Dates of relevant experience:	March2012 to present
Brief Description (Brief scope, size, cost etc.):	
	19 facilities,
	1,152 phones,
	Inmate ADP – 19,033
	SCP, ICER, Threads, 3-Way Call Detection, Covert Alert, Crime Tip

Appendix G

References

Complete a separate form for each of three (3) references

Relevant Project:	Missouri Department of Corrections
Relevancy to DOCCS Requirements:	ITS provider / Investigative services
Reference Organization Name:	Office of Inspector General
Address:	2729 Plaza Drive
City, State, Zip Code:	Jefferson City, MO 65102
Contact Name:	Amy Roderick
Title/Position:	Inspector General
Phone Number:	573-526-6504
Email:	amy.roderick@doc.mo.gov
Specific Role:	Program Manager / Senior Account Manager
Dates of relevant experience:	March2011 to present
Brief Description (Brief scope, size, cost etc.):	
	24 facilities,
	2,032 phones,
	Inmate ADP – 31,875
	SCP, Inmate Debit, Guarded Exchange investigative services, Threads, Word Spotting, E-Imports,
	3-Way Call Detection, Covert Alert, Crime Tip

Appendix G



Summary

Amy has been with Securus for more than 16 years. In her role as Director of Account Management for the Department of Corrections (DOC), she is responsible for successful implementations of new assigned business, contract management specific to State DOC's and service and support of existing valued customers.

Amy is dedicated to customer service. She is passionate about her customers and works diligently to ensure their satisfaction with Securus' performance.

Experience

Securus Technologies, Inc.
Present

Nov 2011 to

Sr. Territory Manager/Director of Account Management - Department of Corrections

- First point of contact for providing implementation support, contract management, customer service and support for the following Department of Corrections:
 - Missouri Department of Corrections
 - Louisiana Department of Corrections
 - Illinois Department of Corrections
 - North Dakota Department of Corrections and Rehabilitation

Manager - Corporate Escalations
2011

March 2009 to Nov

The Corporate Escalations Team (CET) oversees and manages resolution of customer issue(s) after all prior approaches to resolve the issue(s) have failed. CET ensures that critical customer issues, those that jeopardize contract continuation, are resolved expeditiously and that customer's needs are satisfied as quickly as possible. CET's responsibilities are to:

- Own escalated issues and drive resolution in a timely manner
- Be a single point of contact for Sales while a customer issues is overseen by CET
- Identify root cause and implement changes to prevent similar future issues

Sr. Account Manager – Partner Solutions Department
2009

Aug 2002– March

During this time at Securus, Amy managed over multi-million dollar accounts including Sprint/Embarq, Verizon, SBC, AT&T and PCS.

Responsibilities included but not limited to:

- Controlling new project proposals and implementation management of those projects.
- Assisted in identifying Company performance issues and executing action plan to close performance gaps
- Implemented standard processes and guidelines to ensure effective and efficient operations
- Promote product and service capabilities
- Assisted in development and management of national request-for-proposal (RFP) fulfillment process

Regulatory Analyst -
2002

December 1999 – August

First assignment for Securus was in the position of regulatory analyst. In that role Amy assisted in managing all Regulatory functions for Company. Responsibilities included:

- Payment and tracking of all property taxes
- Analysis and responses to all Public Utility Commission complaints
- Managed, tracked and completed Regulatory reports for the Company
- Assisted the Director in rate audits, rate analysis and rate regulatory compliance

Education

University of North Texas – 1987 - 1989

Complete a separate form for each proposed staff person and attach full résumé.

Vendor Name: Securus Technologies, Inc. (Prime Contractor)

Name of Proposed Staff: James Rogers

Position and Title: Technical Liaison

Name of Firm: PSRI Technologies, LLC

Telephone Number: 573/636-9696

Role in This Contract: Technical Support

Years of Experience - Total: 20 years

Years of Experience - With Current Firm: 8 years

Education (Degree(s) and Specialization): Lincoln University, Jefferson City, MO 1980 – 1984 (BS – Computer Information Systems)

Rogers
References

Complete a separate form for each of three (3) references

Relevant Project: State of Missouri Offender Monitoring system

Relevancy to DOCCS Requirements: Providing Staffing Services

Reference Organization Name: Sentinel Offender Services (formerly Securicor)

Address: 201 Technology Drive

City, State, Zip Code: Irvine, CA 92618

Contact Name: Leo Carson

Title/Position: Vice President, Strategic Sales

Phone Number: (888) 843-5590

Email: leo.carson@sentrak.us.com

Specific Role: Technical Support

Dates of relevant experience: July 2007 to June 2010

Brief Description (Brief scope, size, cost etc.): PSRI Tech worked as a subcontractor to Sentinel Offender Services, LLC on the Offender Monitoring Project at the State of Missouri to monitor the activities of those that were placed on house arrest. The offenders were equipped with a GPS tracking device attached by PSRI's field technicians. They were equipped with a 48-channel GPS receiver for improved point acquisition and precise location identification. The offenders were monitored 24 hours a day to verify their location.

Rogers
References

Complete a separate form for each of three (3) references

Relevant Project: Third Party Liability Fund Recovery-Health Insurance Carriers following HIPPA

Relevancy to DOCCS Requirements: Providing Staffing Services

Reference Organization Name: Health Management Systems, Inc.

Address: 9020 Stony Point Parkway Suite 165

City, State, Zip Code: Richmond, Virginia 23235

Contact Name: Michelle Johnson

Title/Position: Project Manager

Phone Number: (573) 230-7038

Email: mjohnson@prsiusa.com

Specific Role: Managed contractor staff

Dates of relevant experience: October 2003 to July 2013

Brief Description (Brief scope, size, cost etc.): PSRI Tech worked as a subcontractor to Professional Services & Resources, Inc. (PSRI) providing outbound call center support on an ongoing revenue enhancement project in conjunction with the subrogation of third party liability (Title XIX/TPL) claims to private health insurance carriers. PSRI Tech monitored and recorded all calls, inbound and out bound. The purpose of this monitoring was to ensure that customer service representatives followed State of Missouri guidelines in accordance with our contract.

Rogers
References

Complete a separate form for each of three (3) references

Relevant Project: Quality Assurance, Associates and IT Support for the State of MO Social Services Call Center

Relevancy to DOCCS Requirements: Providing Staffing Services

Reference Organization Name: State of Missouri Department of Social Services/Family Support Division

Address: PO Box 2320

City, State, Zip Code: Jefferson City, MO 65102-2320

Contact Name: John Ginwright

Title/Position: State Project Manager

Phone Number: (573) 751-4995

Email: john.b.ginwright@dss.mo.gov

Specific Role: Managed contractor staff

Dates of relevant experience: August 2006 to June 2013

Brief Description (Brief scope, size, cost etc.): PSRI Tech provided call center staffing and IT Support for the State of Missouri Social Services Call Center. We provided the following services:

- Developed a "scorecard" that was used to measure the subjective metrics, such as customer courtesy;
- Monitored calls outgoing and incoming calls (Note: These calls were also recorded and used for training);
- Provided Customer Service Representatives; Quality Assurance Specialists;
- Provided IT Network and Infrastructure design, implementation and monitoring and;
- Provided phone system support through our Mitel Vendor.

Complete a separate form for each proposed staff person and attach full résumé.

Vendor Name: Securus Technologies, Inc. (Prime Contractor)

Name of Proposed Staff: Natasha Conley

Position and Title: President

Name of Firm: PSRI Technologies, LLC

Telephone Number: 573/636-9696

Role in This Contract: Service Support for prime contractor

Years of Experience - Total: 23 years

Years of Experience - With Current Firm: 16 years

Education (Degree(s) and Specialization):

University of Central Missouri, Warrensburg, MO 1982 – 1986 (BSBA – CIS)

University of Illinois, Springfield, IL 1992 – 1994 (MS – MIS)

Case Western Reserve University, Cleveland, OH 2014 – Present (PhD Candidate)

Conley
References

Complete a separate form for each of three (3) references

Relevant Project: State of Missouri Offender Monitoring system

Relevancy to DOCCS Requirements: Providing Staffing Services

Reference Organization Name: Sentinel Offender Services (formerly Securicor)

Address: 201 Technology Drive

City, State, Zip Code: Irvine, CA 92618

Contact Name: Leo Carson

Title/Position: Vice President, Strategic Sales

Phone Number: (888) 843-5590

Email: leo.carson@sentrak.us.com

Specific Role: Technical Support

Dates of relevant experience: July 2007 to June 2010

Brief Description (Brief scope, size, cost etc.): PSRI Tech worked as a subcontractor to Sentinel Offender Services, LLC on the Offender Monitoring Project at the State of Missouri to monitor the activities of those that were placed on house arrest. The offenders were equipped with a GPS tracking device attached by PSRI's field technicians. They were equipped with a 48-channel GPS receiver for improved point acquisition and precise location identification. The offenders were monitored 24 hours a day to verify their location.

Conley
References

Complete a separate form for each of three (3) references

Relevant Project: Third Party Liability Fund Recovery-Health Insurance Carriers following HIPPA

Relevancy to DOCCS Requirements: Providing Staffing Services

Reference Organization Name: Health Management Systems, Inc.

Address: 9020 Stony Point Parkway Suite 165

City, State, Zip Code: Richmond, Virginia 23235

Contact Name: Michelle Johnson

Title/Position: Project Manager

Phone Number: (573) 230-7038

Email: mjohnson@prsiusa.com

Specific Role: Managed contractor staff

Dates of relevant experience: October 2003 to July 2013

Brief Description (Brief scope, size, cost etc.): PSRI Tech worked as a subcontractor to Professional Services & Resources, Inc. (PSRI) providing outbound call center support on an ongoing revenue enhancement project in conjunction with the subrogation of third party liability (Title XIX/TPL) claims to private health insurance carriers. PSRI Tech monitored and recorded all calls, inbound and out bound. The purpose of this monitoring was to ensure that customer service representatives followed State of Missouri guidelines in accordance with our contract.

Conley
References

Complete a separate form for each of three (3) references

Relevant Project: Quality Assurance, Associates and IT Support for the State of MO Social Services Call Center

Relevancy to DOCCS Requirements: Providing Staffing Services

Reference Organization Name: State of Missouri Department of Social Services/Family Support Division

Address: PO Box 2320

City, State, Zip Code: Jefferson City, MO 65102-2320

Contact Name: John Ginwright

Title/Position: State Project Manager

Phone Number: (573) 751-4995

Email: john.b.ginwright@dss.mo.gov

Specific Role: Managed contractor staff

Dates of relevant experience: August 2006 to June 2013

Brief Description (Brief scope, size, cost etc.): PSRI Tech provided call center staffing and IT Support for the State of Missouri Social Services Call Center. We provided the following services:

- Developed a "scorecard" that was used to measure the subjective metrics, such as customer courtesy;
- Monitored calls outgoing and incoming calls (Note: These calls were also recorded and used for training);
- Provided Customer Service Representatives; Quality Assurance Specialists;
- Provided IT Network and Infrastructure design, implementation and monitoring and;
- Provided phone system support through our Mitel Vendor.

Complete a separate form for each proposed staff person and attach full résumé.

Vendor Name: Securus Technologies, Inc. (Prime Contractor)

Name of Proposed Staff: Carol Walcher

Position and Title: Customer Service Manager

Name of Firm: G5 Tek Solutions, LLC (Sub-contractor)

Telephone Number: 678.714.3937

Role in This Contract: Service Support for prime contractor

Years of Experience - Total: 20 years

Years of Experience - With Current Firm: 5 years

Education (Degree(s) and Specialization): Draughons Business School, Little Rock, AR 1977 – 1978

Walcher
References

Complete a separate form for each of three (3) references

Relevant Project: IDOC Inmate Telephone Contract

Relevancy to DOCCS Requirements: Similar Service Support for DOCCS

Reference Organization Name: Securus Technologies, Inc.

Address: 14651 Dallas Parkway, Suite 600

City, State, Zip Code: Dallas, TX 75254

Contact Name: Amy Hewitt

Title/Position: Director of DOC Accounts Management

Phone Number: 214.310.3683

Email: AHewitt@Securustechnologies.com

Specific Role: Lead Account Manager for the Illinois DOC Inmate Telephone Contract

Dates of relevant experience: January 2013 - Present

Brief Description (Brief scope, size, cost etc.): G5 manages 18 full-time employees performing field service, site administration, PIN/PAN processing and installation for the ITS platform at 46 IDOC facilities state-wide. G5 is also performing installation, field service and collections for kiosks supporting IDOC.

Walcher
References

Complete a separate form for each of three (3) references

Relevant Project: DEDOC Inmate Telephone Contract

Relevancy to DOCCS Requirements: Similar Service Support for DOCCS

Reference Organization Name: Global Tel*Link (GTL)

Address: 6741 Blue Church Rd. S.

City, State, Zip Code: Coopersburg, PA 18036

Contact Name: Tom Fulton

Title/Position: Field Services Manager

Phone Number: 610.282.3682

Email: tom.fulton@gtl.net

Specific Role: Manages on-going support of the Inmate Telephone Contract

Dates of relevant experience: October 2010- Present

Brief Description (Brief scope, size, cost etc.): G5 manages 5 full-time employees performing field service, site administration and reporting for the DE DOC ITS platform and kiosk service & collections at 13 DE DOC facilities statewide.

Walcher
References

Complete a separate form for each of three (3) references

Relevant Project: Hillsborough County (Tampa), Putnam County and Hernando County, FL Inmate Telephone Contracts

Relevancy to DOCCS Requirements: Service and Site Administration of Inmate Telephone System

Reference Organization Name: CenturyLink

Address: PO Box 7977

City, State, Zip Code: Overland Park, KS 66207

Contact Name: Everett Martin

Title/Position: Field Service Manager

Phone Number: 407-830-3344

Email: Everett.J.Martin@centurylink.com

Specific Role: Manages the Inmate phone contract for Hillsborough and other Florida counties

Dates of relevant experience: July 2011- present

Brief Description (Brief scope, size, cost etc.): G5 performs field service, site administration, call-center support and data reporting.

Empty form lines for additional information.

Complete a separate form for each proposed staff person and attach full résumé.

Vendor Name: Securus Technologies, Inc. (Prime Contractor)

Name of Proposed Staff: Terri H. Whitfield

Position and Title: Owner and President

Name of Firm: G5 Tek Solutions, LLC (Sub-contractor)

Telephone Number: 404.374.6350

Role in This Contract: Service Support for prime contractor

Years of Experience - Total: 25 years

Years of Experience - With Current Firm: 9 years

Education (Degree(s) and Specialization): Georgia State University, Atlanta, GA 1982 - 1985

Whitfield
References

Complete a separate form for each of three (3) references

Relevant Project: IDOC Inmate Telephone Project and IDOC Interactive Kiosk Project

Relevancy to DOCCS Requirements: Similar Service Support for DOCCS

Reference Organization Name: Illinois Department of Corrections

Address: 4500 6th Street Road #207

City, State, Zip Code: Springfield, Ill. 62703

Contact Name: Mike Mitchell

Title/Position: Telecom Manager

Phone Number: 217.557.6020 x 6399

Email: Michael.d.mitchell@doc.illinois.gov

Specific Role: Manages Inmate Telephone Contract

Dates of relevant experience: January 2013 - Present

Brief Description (Brief scope, size, cost etc.): G5 manages 18 full-time employees performing field service, site administration, PIN/PAN processing and installation for the ITS platform at 46 IDOC facilities state-wide. G5 is also performing installation, field service and collections for kiosks supporting IDOC.

Whitfield
References

Complete a separate form for each of three (3) references

Relevant Project: DEDOC Inmate Telephone Contract

Relevancy to DOCCS Requirements: Similar Service Support for DOCCS

Reference Organization Name: Delaware Department of Corrections

Address: 801 Silver Lake Building

City, State, Zip Code: Dover, Delaware, 19904

Contact Name: Kay Buck

Title/Position: Voice Lead at State of Delaware

Phone Number: 302.739.9649

Email: Kay.buck@state.de.us

Specific Role: Supports Inmate Telephone Contract

Dates of relevant experience: October 2010- Present

Brief Description (Brief scope, size, cost etc.): G5 manages 5 full-time employees performing field service, site administration and reporting for the DE DOC ITS platform and kiosk service & collections at 13 DE DOC facilities statewide.

Empty form lines for additional information.

Whitfield

References

Complete a separate form for each of three (3) references

Relevant Project:	SCDOC Inmate Telephone Contract
Relevancy to DOCCS Requirements:	Similar ITS and Required Personnel
Reference Organization Name:	South Carolina Dept. of Corrections
Address:	4444 Broad River Road
City, State, Zip Code:	Columbia, SC 29210
Contact Name:	Tom Barrett
Title/Position:	Assistant Division Director, RIM at SC
Phone Number:	803.896.1755
Email:	Barrett.tom@doc.state.sc.us
Specific Role:	Manages the Inmate phone contract for SCDOC
Dates of relevant experience:	July 2011- present
Brief Description (Brief scope, size, cost etc.):	G5 manages 6 full-time employees performing site administration of the SCDOC ITS platform at 28 SC DOC facilities statewide.

Appendix G

Completed Forms

Attachment C – Proposal Submission Checklist

**Proposal Submission Checklist and
Required Documents**

Required documents	Type of Submission	Include with Bid Submission	Include with Contract Materials
Completed Encouraging NYS Business form (Section 8.5)	Complete form in Attachment C	<input checked="" type="checkbox"/>	
Vendor Reference Form (Appendix F) and Section 6.1	Include three separate references on forms provided in Appendix F of this document. (Subcontractors must also complete three separate references.)	<input checked="" type="checkbox"/>	
Staff Qualification Form (Appendix G)	Complete a separate form for each proposed staff person and attach a full résumé. Complete three (3) References forms for each qualified staff member.	<input checked="" type="checkbox"/>	
Non-Disclosure Agreement (Appendix I)	Recipient agrees not to use the Confidential Information in any way, except for the purpose of the projects or assignments they are performing for DOCCS.		<input type="checkbox"/>
Performance/ Payment Bond (Appendix L)	Review the information in Section 8.14. DOCCS requires the Contractor to furnish without cost to DOCCS a performance/payment bond as security for the faithful performance of the Contract.		<input type="checkbox"/>
Consultant Disclosure (Attachment C & Section 8.10)	Form A should be submitted at the time of contract; Form B is filed annually by May 15.		<input type="checkbox"/>

**Proposal Submission Checklist and
Required Documents**

Required documents	Type of Submission	Include with Bid Submission	Include with Contract Materials
Form ST-220-CA (Section 8.4)	All Bidder should be prepared to verify compliance with NYS Tax Law: http://www.tax.ny.gov/pdf/publications/sales/pub223.pdf		<input type="checkbox"/>
Completed Workers' Compensation and Disability Forms (Section 8.9)	Complete and return with Contract documentation Workers' Compensation - http://www.wcb.ny.gov/content/onlineforms/obtainC105.jsp Disability Benefits - http://www.wcb.ny.gov/content/onlineforms/obtainDB120-1.jsp		<input type="checkbox"/>
	Attachment C documents that are due for submission with proposals should be included with the Technical Proposal.	<input checked="" type="checkbox"/>	

CLOSING

COMPANY SUMMARY

Securus Serves	City, County, State and Federal Governmental Agencies
Providing	Civil and Criminal Justice Technology Solutions
For	Public Safety, Investigation, Corrections and Monitoring Professionals
With Products And Services That Provide	Emergency Response Communication Incident Management Information Management Public Information Inmate Self-Service Investigation Monitoring Verification Inmate Entertainment Trust Funding and more...
Name and Address	Securus Technologies 14651 Dallas Pkwy, Suite 600 Dallas, TX 75254-8815
Family and Friends Website:	www.securustech.net
Agency Website:	www.securustechnologies.com
Management:	Richard A. Smith, CEO Robert Pickens, President Geoff Boyd, CFO Josh Conklin, SVP Sales Russell Roberts, SVP Marketing and Product Strategy
Corporate Office Locations	Dallas, TX; Framingham, MA; Miami, FL; Atlanta, GA
Other Brands Owned	JLG Technologies Satellite Tracking of People (STOP)

Headquartered in Dallas, Texas, and serving nearly 3,500 law enforcement and corrections agencies and 1,200,000 inmates across North America, Securus Technologies is committed to serve and connect by providing emergency response, incident management, public information, investigation, verification, communication, information management, inmate self-service, and monitoring products and services in order to make our world a safer place to live. Securus Technologies focuses on "Connecting what matters". To learn more about our full suite of civil and criminal justice technology solutions, please visit www.securustechnologies.com.

ATTACHMENTS

Attachment A:

Bidder's Conference Form

Attachment B:

Addendum Acknowledgements

Attachment C:

Performance Bond Commitment

BIDDER'S CONFERENCE FORM

Attachments

Bidder's Conference Form

Notice of Intent to Bid & Pre-Registration for Mandatory Pre-Bid Conference

REQUEST FOR PROPOSALS NUMBER: RFP 2016-03	RFP TITLE: Inmate Telephone System
--	------------------------------------

IF YOU INTEND TO SUBMIT A PROPOSAL, you should do the following:

- a. Complete Sections 2 and 3 of this form.
- b. Email the completed form to DOCCS at doccscontracts@doccs.ny.gov (enter *Notice of Intent to Bid—RFP 2016-03* in the subject line of the email).

IF YOU ARE NOT SUBMITTING A PROPOSAL, you should do the following:

- a. Complete Sections 1 and 3 of this form.
- b. Return the completed form to DOCCS by email at doccscontracts@doccs.ny.gov.
- c. Please indicate your reason for not submitting a proposal.

Section 1

- We do not provide the requested service/technology/commodity. Please remove our firm from your mailing list.
- We cannot submit a bid at this time because _____
- Please retain our firm on this list.

Section 2

- We intend to submit a response to this Request for Proposals

List the individuals (4 maximum) who will attend the mandatory pre-bid conference.
Pre-registration is required for attendance.

Attendee Name	Company	Phone number
1 Adam J Mercer	Securus Technologies, Inc.	(904) 613-8477
2		
3		
4		

Section 3: Designated Contact Person

Name of Firm: Securus Technologies, Inc.

Fed ID. NO.: 75-2722144 Vendor ID 1100163749

Address 1: 14651 Dallas Parkway, Suite 600, Dallas, Texas 75254

Address 2: _____

Telephone: 972-277-0300 Email: bpickens@securustechnologies.com

Printed Name: Robert E. Pickens Title: President

Date: December 1, 2016

ADDENDUM ACKNOWLEDGEMENTS

Attachments

Addendum Acknowledgements



Corrections and Community Supervision

ANDREW M. CUOMO
Governor

ANTHONY J. ANNUCCI
Acting Commissioner

Addendum I to RFP 2016-02, Inmate Telephone System

Vendor Assurance of No Conflict of Interest or Detrimental Effect

The Firm offering to provide services pursuant to this Request for Proposals 2016-02, *Inmate Telephone System*, as a contractor, joint venture contractor, subcontractor, or consultant, attests that its performance of the services outlined in this RFP does not and will not create a conflict of interest with nor position the Firm to breach any other contract currently in force with the State of New York.

Furthermore, the Firm attests that it will not act in any manner that is detrimental to any State project on which the Firm is rendering services. Specifically, the Firm attests that:

1. The fulfillment of obligations by the Firm, as proposed in the response, does not violate any existing contracts or agreements between the Firm and the State;
2. The fulfillment of obligations by the Firm, as proposed in the response, does not and will not create any conflict of interest, or perception thereof, with any current role or responsibility that the Firm has with regard to any existing contracts or agreements between the Firm and the State;
3. The fulfillment of obligations by the Firm, as proposed in the response, does not and will not compromise the Firm's ability to carry out its obligations under any existing contracts between the Firm and the State;
4. The fulfillment of any other contractual obligations that the Firm has with the State will not affect or influence its ability to perform under any contract with the State resulting from this RFP;
5. During the negotiation and execution of any contract resulting from this RFP 2016-02, the Firm will not knowingly take any action or make any decision which creates a potential for conflict of interest or might cause a detrimental impact to the State as a whole including, but not limited to, any action or decision to divert resources from one State project to another;

Addendum I to RFP 2016-02, Inmate Telephone System

6. In fulfilling obligations under each of its State contracts, including any contract which results from this RFP 2016-02, the Firm will act in accordance with the terms of each of its State contracts and will not knowingly take any action or make any decision which might cause a detrimental impact to the State as a whole including, but not limited to, any action or decision to divert resources from one State project to another;
7. No former officer or employee of the State who is now employed by the Firm, nor any former officer or employee of the Firm who is now employed by the State, has played a role with regard to the administration of this contract procurement in a manner that may violate section 73(8)(a) of the State Ethics Law; and
8. The Firm has not and shall not offer to any employee, member or director of the State any gift, whether in the form of money, service, loan, travel, entertainment, hospitality, thing or promise, or in any other form, under circumstances in which it could reasonably be inferred that the gift was intended to influence said employee, member or director, or could reasonably be expected to influence said employee, member or director, in the performance of the official duty of said employee, member or director or was intended as a reward for any official action on the part of said employee, member or director.

Firms responding to this RFP 2016-02 should note that the State recognizes that conflicts may occur in the future because a Firm may have existing or new relationships. The State will review the nature of any such new relationship and reserves the right to terminate the contract for cause if, in its judgment, a real or potential conflict of interest cannot be cured.

"Accepted and Agreed To":

	Robert E. Pickens	President	12/19/2016
Signature	Name	Title	Date



Corrections and Community Supervision

ANDREW M. CUOMO
Governor

ANTHONY J. ANNUCCI
Acting Commissioner

Addendum I to RFP 2016-02, Inmate Telephone System

Vendor Assurance of No Conflict of Interest or Detrimental Effect

The Firm offering to provide services pursuant to this Request for Proposals 2016-02, *Inmate Telephone System*, as a contractor, joint venture contractor, subcontractor, or consultant, attests that its performance of the services outlined in this RFP does not and will not create a conflict of interest with nor position the Firm to breach any other contract currently in force with the State of New York.

Furthermore, the Firm attests that it will not act in any manner that is detrimental to any State project on which the Firm is rendering services. Specifically, the Firm attests that:

1. The fulfillment of obligations by the Firm, as proposed in the response, does not violate any existing contracts or agreements between the Firm and the State;
2. The fulfillment of obligations by the Firm, as proposed in the response, does not and will not create any conflict of interest, or perception thereof, with any current role or responsibility that the Firm has with regard to any existing contracts or agreements between the Firm and the State;
3. The fulfillment of obligations by the Firm, as proposed in the response, does not and will not compromise the Firm's ability to carry out its obligations under any existing contracts between the Firm and the State;
4. The fulfillment of any other contractual obligations that the Firm has with the State will not affect or influence its ability to perform under any contract with the State resulting from this RFP;
5. During the negotiation and execution of any contract resulting from this RFP 2016-02, the Firm will not knowingly take any action or make any decision which creates a potential for conflict of interest or might cause a detrimental impact to the State as a whole including, but not limited to, any action or decision to divert resources from one State project to another.

Addendum I to RFP 2016-02, Inmate Telephone System

6. In fulfilling obligations under each of its State contracts, including any contract which results from this RFP 2016-02, the Firm will act in accordance with the terms of each of its State contracts and will not knowingly take any action or make any decision which might cause a detrimental impact to the State as a whole including, but not limited to, any action or decision to divert resources from one State project to another;
7. No former officer or employee of the State who is now employed by the Firm, nor any former officer or employee of the Firm who is now employed by the State, has played a role with regard to the administration of this contract procurement in a manner that may violate section 73(8)(a) of the State Ethics Law; and
8. The Firm has not and shall not offer to any employee, member or director of the State any gift, whether in the form of money, service, loan, travel, entertainment, hospitality, thing or promise, or in any other form, under circumstances in which it could reasonably be inferred that the gift was intended to influence said employee, member or director, or could reasonably be expected to influence said employee, member or director, in the performance of the official duty of said employee, member or director or was intended as a reward for any official action on the part of said employee, member or director.

Firms responding to this RFP 2016-02 should note that the State recognizes that conflicts may occur in the future because a Firm may have existing or new relationships. The State will review the nature of any such new relationship and reserves the right to terminate the contract for cause if, in its judgment, a real or potential conflict of interest cannot be cured.

"Accepted and Agreed To":

	/	Terr Whiffield	/	President	/	12/16/2016
Signature		Name		Title		Date



Corrections and Community Supervision

ANDREW M. CUOMO
Governor

ANTHONY J. ANNUCCI
Acting Commissioner

Addendum I to RFP 2016-02, Inmate Telephone System

Vendor Assurance of No Conflict of Interest or Detrimental Effect

The Firm offering to provide services pursuant to this Request for Proposals 2016-02, *Inmate Telephone System*, as a contractor, joint venture contractor, subcontractor, or consultant, attests that its performance of the services outlined in this RFP does not and will not create a conflict of interest with nor position the Firm to breach any other contract currently in force with the State of New York.

Furthermore, the Firm attests that it will not act in any manner that is detrimental to any State project on which the Firm is rendering services. Specifically, the Firm attests that:

1. The fulfillment of obligations by the Firm, as proposed in the response, does not violate any existing contracts or agreements between the Firm and the State;
2. The fulfillment of obligations by the Firm, as proposed in the response, does not and will not create any conflict of interest, or perception thereof, with any current role or responsibility that the Firm has with regard to any existing contracts or agreements between the Firm and the State;
3. The fulfillment of obligations by the Firm, as proposed in the response, does not and will not compromise the Firm's ability to carry out its obligations under any existing contracts between the Firm and the State;
4. The fulfillment of any other contractual obligations that the Firm has with the State will not affect or influence its ability to perform under any contract with the State resulting from this RFP;
5. During the negotiation and execution of any contract resulting from this RFP 2016-02, the Firm will not knowingly take any action or make any decision which creates a potential for conflict of interest or might cause a detrimental impact to the State as a whole including, but not limited to, any action or decision to divert resources from one State project to another;



Corrections and Community Supervision

ANDREW M. CUOMO
Governor

ANTHONY J. ANNUCCI
Acting Commissioner

Addendum II to RFP 2016-02, Inmate Telephone System

Amended Language and Amended Cost Proposal Form (Appendix H)

The NYS Department of Corrections and Community Supervision (DOCCS), is amending the sections of the Request for Proposals (RFP) 2016-02, *Inmate Telephone System*, as noted below. In addition, based on the changes to the language in the following sections and the *Official Responses to Questions*, DOCCS is amending the Appendix H, *Cost Proposal Form*.

Bidders must sign the acknowledgment at the end of this Addendum II to illustrate their understanding of, and agreement with, the changes represented herein and agreement to use the attached Appendix H, Amended Proposal Cost Form, to complete the requisite Cost Proposal for this RFP solicitation.

The following RFP subsections are hereby replaced by the specific language below:

3.10 INFORMATION OWNERSHIP

DOCCS shall own all inmate data and call recordings and DOCCS' information developed, stored or used in the ITS. Vendor shall provide DOCCS access to customer account records excluding private financial data.

3.12 PHASE-OUT PLAN

The vendor shall provide DOCCS with a full explanation of how it will handle a transition to a succeeding vendor at the end of the contract period. The plan must describe how the vendor will 1) provide any and all data including call recordings to the succeeding vendor or DOCCS in a manner that will allow DOCCS to access individual recordings using the succeeding vendor's system; or 2) a mechanism that will allow DOCCS to search for and access individual recordings for up to one year after the transition is complete. The plan must also describe how "Flagged" call recordings, which are retained indefinitely, will be provided and/or made accessible to DOCCS following the transition to the succeeding vendor. The plan must also describe how the proposed transition plan will maintain the chain of custody of individual recordings, whether Flagged or not, should they be needed as evidence following the transition to the new system. Any DOCCS-owned equipment located outside DOCCS' sites, such as recording equipment and software, must be provided to the next contractor or DOCCS at no cost. DOCCS shall own all promised-based equipment installed and all data.

Addendum II to RFP 2016-02, Inmate Telephone System

7.2.1 Domestic

The rate proposed and charged by the vendor shall be a single, per minute rate inclusive of all vendor fees, connect charges or other costs for all calls within the United States, its territories and protectorates, and Canada. The rate shall be the same for pre-paid and collect calls. Call rates may not exceed \$0.050.

7.2.2 International

Although DOCCS does not allow international calls currently, the vendor shall propose a rate structure for international calls detailing rates by country. The rates for international calls shall be a single per minute rate by country inclusive of all vendor fees, connect charges or other costs. DOCCS reserves the right to implement any alternative international calling services and does not guarantee minimum international calling volume. Any location not within the area defined as covered by the domestic rate as detailed above shall be treated as international. The rate for each country shall be the same rate for pre-paid and collect calls. Also, please propose a blended rate that would be applicable for all countries at a per-minute rate.

In addition, based on the changes to the RFP 2016-02 language above, please use the attached Appendix H, *Amended Cost Proposal Form*, attached to this Addendum II.

As provided in the response to Question 47 in the *Official Responses to Questions*, please note that DOCCS will not entertain bids with a vendor as a prime on one bid and a subcontractor to another bid. Additionally, each vendor may only be part of one submission."

"Accepted and Agreed To"

Robert E. Pickens / Robert E. Pickens / President / 1/16/2017
Signature Name Title Date

STATE OF TEXAS)
) SS:
County of Dallas)

On the 8th day of January, 2017, before me personally appeared Robert E. Pickens, to me known, who being by me duly sworn, that he/she is the President of the Securus Technologies, Inc., the corporation described herein which executed the foregoing instrument; and that he/she signed his/her name thereto by order of the board of directors of said corporation.

Diane Wendling
NOTARY PUBLIC

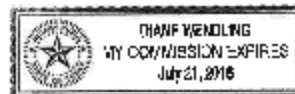

Amended Appendix H Cost Proposal Form

Prime Contractor Name: _____

Subcontractor Name(s) if applicable: _____

Authorized Signature: _____

Instructions: Complete the Amended Cost Proposal Form showing the costs for the Contract Services requested. The costs shall be considered to be inclusive of all travel, overhead, profit, and administrative expenses. The cost proposal form shall be submitted in a separate self-addressed stamped envelope in the event the Bidder is disqualified and the Cost Proposal is unopened and returned.

Vendor shall provide rates based on three decimal places (e.g. \$0.000). Rates shall apply only from the called party's acceptance of a call until the call is terminated rounded to the **nearest** whole minute (calls lasting up to and including 29 seconds over a whole minute shall be rounded down, calls greater than or equal to 30 seconds over a whole minute shall be rounded up.) There shall be no charge for the time for prompts, rate information or other functions. There shall be no additional charges or fees added to the cost of a call.

Domestic Rate: The rate proposed and charged by the vendor shall be a single, per-minute rate inclusive of all vendor fees, connect charges and/or other costs for all calls within the United States, its territories and protectorates, and Canada. **Call rates may not exceed \$0.050.**

Domestic per Minute Rate	Total Cost per Minute (including vendor fees, & surcharges)

International Rates:

The vendor shall propose a rate structure for international calls detailing rates by country. The rates for international calls shall be single, per-minute rates by country inclusive of all vendor fees, connect charges and/or other costs. DOCCS reserves the right to implement any alternative international calling services and does not guarantee minimum international calling volume. Any location not within the area defined as covered by the domestic rate as detailed above shall be treated as international.

Country	Total Cost per Minute (including vendor fees, & surcharges)

Account Holder Fees:

Itemize any fees below that may be incurred by account holders throughout the entire use and closure of the account:

Account Fees	Amount Charged Account Holders
Example: Automated payment fees	\$3.00
Total of all fees:	

Federal and State Surcharges and Taxes:

Identify all federal and state surcharges and taxes that will be applied to the proposed rates for direct-billed and prepaid calls (do not include amount of tax or surcharge):

Taxes and Surcharges

* Automated payments include payments by interactive voice response (IVR).



Corrections and Community Supervision

ANDREW M. CUOMO
Governor

ANTHONY J. ANNUCCI
Acting Commissioner

Addendum III to RFP 2016-02, Inmate Telephone System Amended Appendix K, Proposal Response Forms

The NYS Department of Corrections and Community Supervision (DOCCS), is amending the Request for Proposals (RFP) 2016-02, *Inmate Telephone System*, as indicated herein.

Bidders must sign the acknowledgement at the end of this Addendum III to illustrate understanding of, and agreement with, the changes represented by this Addendum and must use the attached Appendix K, *Amended Proposal Response Forms*, as the integral part of the Technical Proposal due on Monday, January 23, 2017.

DOCCS is correcting the Appendix K by modifying the current field for **Section 3.1.8.2, Simultaneous Access**, on page 2. This section of the Appendix K is corrected to illustrate that 3.1.8.2 is subject to scoring. Please use the attached Appendix K in place of the original to ensure that your Technical Proposal submissions are up to date and correspond with the evaluation process.

If you are in agreement, please sign below, have the signature notarized, and include the original signed Addendum III with your Technical Proposal submissions. Scan and email the signed and notarized Addendum III to doocscontracts@doocs.ny.gov by COB Thursday, January 19, 2017.

"Accepted and Agreed To"

Robert Pickens / Robert Pickens / President / 1/17/17
Signature Name Title Date

STATE OF NEW YORK)
) SS:

County of DALLAS)

On the 17 day of JANUARY, 2017, before me personally appeared Robert Pickens, to me known, who being by me duly sworn, stated that he/she is the President of the Securus Technologies Inc. the corporation described herein which executed the foregoing instrument; and that he/she signed his/her name thereto by order of the board of directors of said corporation.

David M Prichard
NOTARY PUBLIC

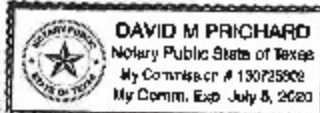

The Halloran State Complex, 1220 Washington Avenue, Albany, NY 12226-2050 | (518) 457-6126 | www.doocs.ny.gov

Appendix K Proposal Response Forms

Submit the completed Appendix K with the Technical Proposal.

Instructions:

1. **Read & Agree column:** Respond to each itemized section and subsection by indicating that you have read the information in the RFP and that you agree with the requirement by marking the box.
2. **Supporting Document(s) Required column:** If the section and/or subsection requires supporting documentation, a Y will appear in this column. Include the requested documents.
3. **Addressed in Proposal and/or Documents Included:** Mark the box in this column to indicate that you have addressed the section/subsection and/or have included the requested documents in your proposal.
4. **Points Awarded:** Bidders will be scored on all items for which a Y appears in this column.
5. **Complete and sign the following certification.**

The undersigned certifies that he/she

- is knowledgeable about the submitting Business Entity's business and operations;
- has read and understands all of the questions contained in the RFP and the instructions on the previous page;
- has supplied full and complete responses for every item listed on pages 2 – 7 of Appendix K *Proposal Response Form*;
- confirms, to the best of his/her knowledge, information, and belief, that the Business Entity's responses are true, accurate and complete, including all attachments; and
- understands that New York State will rely on information disclosed in this proposal when entering into a contract with the Business Entity.

Signature of Owner/Officer: _____

Printed Name of Signatory: _____

Title: _____

Name of Business: _____

Address: _____

City, State, ZIP code: _____

Date: _____

Section	Title	Read & Agreed	Supporting Document(s) Required	Addressed in Proposal and/or Document(s) Included	Points Awarded
Section 1					
1	INTRODUCTION				
1.1	DOCCS MISSION STATEMENT				
1.2	BACKGROUND				
1.3	OVERVIEW OF EXISTING INMATE TELEPHONE SYSTEM (ITS)				
1.4	PURPOSE				
1.5	ISSUING AGENCY				
1.6	DESIGNATED CONTACTS				
1.7	SCHEDULE OF EVENTS				
Section 2					
2	BIDDER INFORMATION				
2.1	TERM OF AGREEMENT	<input type="checkbox"/>			
2.2	COMPLETENESS OF PROPOSAL	<input type="checkbox"/>			
2.3	MODIFICATION OF BIDS	<input type="checkbox"/>			
2.4	WITHDRAWAL OF BIDS	<input type="checkbox"/>			
2.5	INCURRING COSTS	<input type="checkbox"/>			
2.6	MANDATORY PRE-BID CONFERENCE	<input type="checkbox"/>	Y ²	<input type="checkbox"/>	
2.7	PRIME CONTRACTOR RESPONSIBILITY	<input type="checkbox"/>	Y ³	<input type="checkbox"/>	
2.8	BLSI VALUE	<input type="checkbox"/>			

² Appendix J Notice of Intent to Bid

³ If subcontractors are used, they must be fully disclosed in the same manner as required of the prime contractor.

Section	Title	Read & Agreed	Supporting Document(s) Required	Addressed in Proposal and/or Document(s) Included	Points Awarded
2.9	TERMS/DEFINITIONS	<input type="checkbox"/>			
2.10	NYS AND DOCCE POLICIES	<input type="checkbox"/>			
Section 3					
3	SCOPE OF SERVICES	<input type="checkbox"/>			
3.1	SYSTEMS ARCHITECTURE	<input type="checkbox"/>			
3.1.1	Proposed Deployment Model	<input type="checkbox"/>		<input type="checkbox"/>	Y
3.1.2	Scalability	<input type="checkbox"/>		<input type="checkbox"/>	Y
3.1.3	Network Services	<input type="checkbox"/>			
3.1.4	System Trunking	<input type="checkbox"/>		<input type="checkbox"/>	Y
3.1.5	Call Quality	<input type="checkbox"/>		<input type="checkbox"/>	Y
3.1.6	Continuity of Services	<input type="checkbox"/>		<input type="checkbox"/>	Y
3.1.6.1	Backup	<input type="checkbox"/>		<input type="checkbox"/>	Y
3.1.6.2	Uninterruptible Power	<input type="checkbox"/>		<input type="checkbox"/>	Y
3.1.7	Single Clock Source	<input type="checkbox"/>		<input type="checkbox"/>	Y
3.1.8	Recording and Monitoring	<input type="checkbox"/>		<input type="checkbox"/>	Y
3.1.8.1	Investigative Support	<input type="checkbox"/>		<input type="checkbox"/>	Y
3.1.8.2	Simultaneous Access	<input type="checkbox"/>		<input type="checkbox"/>	Y
3.1.8.3	Storage	<input type="checkbox"/>			
3.1.8.4	Chain of Evidence	<input type="checkbox"/>		<input type="checkbox"/>	Y
3.1.8.5	Retrieval	<input type="checkbox"/>		<input type="checkbox"/>	Y
3.1.8.6	Equipment and Network Access	<input type="checkbox"/>		<input type="checkbox"/>	Y
3.1.8.7	Access to Recordings	<input type="checkbox"/>		<input type="checkbox"/>	Y
3.1.8.8	Call Monitoring suppression	<input type="checkbox"/>		<input type="checkbox"/>	Y
3.2	SYSTEMS MANAGEMENT	<input type="checkbox"/>			
3.2.1	Fault Management	<input type="checkbox"/>		<input type="checkbox"/>	Y

Section	Title	Read & Agreed	Supporting Document(s) Required	Addressed in Proposal and/or Document(s) Included	Points Awarded
3.2.2	Configuration Management	<input type="checkbox"/>		<input type="checkbox"/>	Y
3.2.2.1	Provisioning and Active Directory	<input type="checkbox"/>		<input type="checkbox"/>	Y
3.2.3	Accounting Management	<input type="checkbox"/>		<input type="checkbox"/>	Y
3.2.3.1	Third Party Auditing	<input type="checkbox"/>			
3.2.3.2	Call Detail Records (CDR)	<input type="checkbox"/>			
3.2.4	Performance Management	<input type="checkbox"/>		<input type="checkbox"/>	Y
3.3	MANDATORY FUNCTIONS	<input type="checkbox"/>			
3.3.1	Alert Groups	<input type="checkbox"/>	Y	<input type="checkbox"/>	Y
3.3.2	Pre-recorded Names	<input type="checkbox"/>			
3.3.3	Access to Rape Crisis Programs	<input type="checkbox"/>			
3.3.4	Access to Toll-Free Assistance Lines	<input type="checkbox"/>			
3.3.5	Announcements	<input type="checkbox"/>	Y	<input type="checkbox"/>	Y
3.3.6	Automatic Number Identification	<input type="checkbox"/>		<input type="checkbox"/>	Y
3.3.7	Billing Name and Address Lookup	<input type="checkbox"/>		<input type="checkbox"/>	Y
3.3.8	Class of Restriction (COR)	<input type="checkbox"/>		<input type="checkbox"/>	Y
3.3.9	Investigative Tip Line	<input type="checkbox"/>			
3.4	MANDATORY FEATURES	<input type="checkbox"/>			
3.4.1	Harassment Blocks	<input type="checkbox"/>		<input type="checkbox"/>	Y
3.4.2	Call Termination	<input type="checkbox"/>		<input type="checkbox"/>	Y
3.4.3	Number Control	<input type="checkbox"/>			
3.4.4	Personal Allowed Numbers (PAN)	<input type="checkbox"/>			
3.4.5	Phone Scheduler	<input type="checkbox"/>			
3.4.6	Personal Identification Numbers (PIN)	<input type="checkbox"/>			
3.4.7	Administration	<input type="checkbox"/>		<input type="checkbox"/>	Y
3.4.8	Third Party Call Detection	<input type="checkbox"/>		<input type="checkbox"/>	Y

Section	Title	Read & Agree	Supporting Document(s) Required	Addressed in Proposal and/or Document(s) Included	Points Awarded
3.4.9	Hours of Operation	<input type="checkbox"/>			
3.4.10	Call Duration	<input type="checkbox"/>			
3.4.11	Telephone Testing	<input type="checkbox"/>			
3.4.12	Languages	<input type="checkbox"/>		<input type="checkbox"/>	Y
3.4.13	ANI Verification	<input type="checkbox"/>			
3.4.14	Telecommunications/Relay Services for the Deaf	<input type="checkbox"/>		<input type="checkbox"/>	Y
3.4.15	Telephone Accommodations for the Visually Impaired	<input type="checkbox"/>		<input type="checkbox"/>	Y
3.4.16	Call Pattern Analysis and Alerting	<input type="checkbox"/>		<input type="checkbox"/>	Y
3.4.17	Voice Recognition, Identification, and Analysis	<input type="checkbox"/>		<input type="checkbox"/>	Y
3.4.18	Emergency Shut Down	<input type="checkbox"/>		<input type="checkbox"/>	Y
3.5	EQUIPMENT	<input type="checkbox"/>			
3.5.1	Telephones	<input type="checkbox"/>			
3.5.2	Portable Phones	<input type="checkbox"/>			
3.5.3	Peristal and Enclosures	<input type="checkbox"/>			
3.5.4	Tablets	<input type="checkbox"/>			
3.5.4.1	Device Specifications	<input type="checkbox"/>	Y	<input type="checkbox"/>	Y
3.5.5	Wiring	<input type="checkbox"/>			
3.5.6	Compliance	<input type="checkbox"/>			
3.5.7	Restoration of Facilities	<input type="checkbox"/>			
3.5.8	Inventory	<input type="checkbox"/>	Y		
3.5.9	Environmental	<input type="checkbox"/>		<input type="checkbox"/>	Y
3.5.10	Servers and Processors	<input type="checkbox"/>	Y	<input type="checkbox"/>	Y
3.5.11	New Equipment	<input type="checkbox"/>	Y	<input type="checkbox"/>	Y
3.6	SOFTWARE ENHANCEMENTS AND UPGRADES	<input type="checkbox"/>	Y	<input type="checkbox"/>	Y
3.7	MAINTENANCE	<input type="checkbox"/>		<input type="checkbox"/>	Y

Section	Title	Read & Agreed	Supporting Document(s) Required	Addressed in Proposal and/or Document(s) Included	Points Awarded
3.7.1	Maintenance Responsibility	<input type="checkbox"/>			
3.7.2	Damage	<input type="checkbox"/>			
3.7.3	Maintenance Window	<input type="checkbox"/>			
3.7.4	Maintenance Center Location	<input type="checkbox"/>			
3.7.5	Maintenance Staff Experience	<input type="checkbox"/>			
3.7.6	Preventive Maintenance	<input type="checkbox"/>			
3.7.7	Remedial Maintenance	<input type="checkbox"/>			
3.7.8	Maintenance Request Reports	<input type="checkbox"/>			
3.8	TRANSITION/MIGRATION	<input type="checkbox"/>		<input type="checkbox"/>	Y
3.8.1	Project Management	<input type="checkbox"/>	Y	<input type="checkbox"/>	Y
3.8.1.1	Project Manager	<input type="checkbox"/>			
3.8.1.2	DOCCS' Resources	<input type="checkbox"/>			
3.8.1.3	Site Survey	<input type="checkbox"/>			
3.8.2	Call Recording Migration	<input type="checkbox"/>		<input type="checkbox"/>	Y
3.8.3	Fallback Plan	<input type="checkbox"/>		<input type="checkbox"/>	Y
3.8.4	Acceptance Testing	<input type="checkbox"/>			
3.8.5	Equipment Disposal	<input type="checkbox"/>			
3.9	DATA EXCHANGE	<input type="checkbox"/>			
3.9.1	National Information Exchange Model (NIEM) Standards	<input type="checkbox"/>			
3.9.2	Data Reconciliation	<input type="checkbox"/>			
3.10	INFORMATION OWNERSHIP	<input type="checkbox"/>			
3.11	SECURITY	<input type="checkbox"/>		<input type="checkbox"/>	Y
3.11.1	IIS System Security	<input type="checkbox"/>	Y	<input type="checkbox"/>	Y
3.11.2	Jurisdiction	<input type="checkbox"/>			
3.11.3	Compliance	<input type="checkbox"/>			

Section	Title	Read & Agreed	Supporting Document(s) Required	Addressed in Proposal and/or Document(s) Included	Points Awarded
3.11.4	Background Checks	<input type="checkbox"/>			
3.11.5	Information Security Breach	<input type="checkbox"/>	Y	<input type="checkbox"/>	Y
3.12	PHASE-OUT PLAN	<input type="checkbox"/>			
3.13	TRAINING	<input type="checkbox"/>	Y	<input type="checkbox"/>	Y
3.14	DOCUMENTATION	<input type="checkbox"/>			
3.15	REPORTING	<input type="checkbox"/>	Y	<input type="checkbox"/>	Y
Section 4					
4	CUSTOMER SERVICE				
4.1	SUPPORT SERVICES FOR DOCCS				
4.1.1	Principal Technical Support Representatives	<input type="checkbox"/>			
4.1.2	Toll-Free Access	<input type="checkbox"/>			
4.1.3	DOCCS Authorized Representatives	<input type="checkbox"/>			
4.1.4	Gate Clearance	<input type="checkbox"/>			
4.1.5	Tinkering System	<input type="checkbox"/>		<input type="checkbox"/>	Y
4.1.6	DOCCS' Access to Customer Information	<input type="checkbox"/>		<input type="checkbox"/>	Y
4.1.7	Court Evidence & Expert Witness Testimony	<input type="checkbox"/>			
4.2	SUPPORT SERVICES FOR CUSTOMERS	<input type="checkbox"/>		<input type="checkbox"/>	Y
4.2.1	Toll-Free Access	<input type="checkbox"/>			
4.2.2	Executive Order Number 28	<input type="checkbox"/>			
4.2.3	Customer Account Access	<input type="checkbox"/>		<input type="checkbox"/>	Y
4.2.4	Customer Outreach	<input type="checkbox"/>			
4.2.5	Call Backing	<input type="checkbox"/>		<input type="checkbox"/>	Y
4.2.6	Vendor Account Policies	<input type="checkbox"/>			

Section	Title	Read & Agreed	Supporting Document(s) Required	Addressed in Proposal and/or Document(s) Included	Points Awarded
4.2.7	Vendor Policy Charges	<input type="checkbox"/>			
4.2.8	Aggregated Billing Account for DOCCS-Approved Organizations	<input type="checkbox"/>	Y	<input type="checkbox"/>	Y
Section 5					
5	PERFORMANCE STANDARDS				
5.1	SERVICE OBJECTIVES	<input type="checkbox"/>		<input type="checkbox"/>	Y
5.1.1	Facility Service Objectives				
5.1.2	Customer Service Objectives				
5.2	RESOLUTION OF REPORTED PROB. FMS	<input type="checkbox"/>		<input type="checkbox"/>	Y
5.2.1	Failure to Comply				
5.2.2	Escalation Requirements				
5.3	PERFORMANCE REVIEWS	<input type="checkbox"/>	<input type="checkbox"/>		
Section 6					
6	VENDOR QUALIFICATIONS				
6.1	COMPANY EXPERIENCE	<input type="checkbox"/>	Y	<input type="checkbox"/>	Y
6.2	PAST PERFORMANCE				
6.2.1	Security Incidents	<input type="checkbox"/>		<input type="checkbox"/>	Y
6.2.2	Performance Data	<input type="checkbox"/>		<input type="checkbox"/>	Y
6.2.3	Legal Validity	<input type="checkbox"/>		<input type="checkbox"/>	Y
6.3	STAFF QUALIFICATIONS	<input type="checkbox"/>		<input type="checkbox"/>	Y
6.3.1	Staffing Numbers and Qualifications	<input type="checkbox"/>		<input type="checkbox"/>	Y
6.3.2	Staff Disqualification	<input type="checkbox"/>			
6.3.3	Staff Resignation or Discharge	<input type="checkbox"/>			
6.4	VENDOR RESPONSIBILITY	<input type="checkbox"/>			

Section	Title	Read & Agreed	Supporting Document(s) Required	Addressed in Proposal and/or Document(s) Included	Points Awarded
6.4.1	Vendor Responsibility Requirements	<input type="checkbox"/>	Y ¹	<input type="checkbox"/>	
6.4.2	Complaint History	<input type="checkbox"/>	Y	<input type="checkbox"/>	
Section 7	7				
	COMPLETE THIS SECTION SEPARATELY				
Section 8	8				
	CONTRACTUAL ISSUES				
8.1	APPENDIX A/ORDER OF PRECEDENCE	<input type="checkbox"/>			
8.2	ETHICS COMPLIANCE	<input type="checkbox"/>			
8.3	PROCUREMENT LOBBYING ACT	<input type="checkbox"/>			
8.4	SALES AND COMPENSATING USE TAX CERTIFICATION REQUIREMENTS	<input type="checkbox"/>			
8.5	ENCOURAGING THE USE OF NYS BUSINESS	<input type="checkbox"/>			
8.6	DIVERSITY PRACTICES	<input type="checkbox"/>	Y ²	<input type="checkbox"/>	Y
8.7	M/WBE AND EEO REQUIREMENTS	<input type="checkbox"/>			
8.8	Use of Service-Disabled Veteran-Owned Business Enterprises in Contract Performance	<input type="checkbox"/>			
8.9	INDEMNIFICATION	<input type="checkbox"/>			
8.10	CONTRACTOR INSURANCE REQUIREMENTS	<input type="checkbox"/>			
8.11	CONSULTANT DISCLOSURE REPORTING REQUIREMENTS	<input type="checkbox"/>			
8.12	FREEDOM OF INFORMATION LAW/TRADE SECRETS	<input type="checkbox"/>			

¹ Appendix E: Vendor Responsibility Information (complete online questionnaire or submit the questionnaire with Technical Proposal)

² Appendix M: Diversity Practices: Complete, sign, and include requested forms.

Section	Title	Read & Agreed	Supporting Document(s) Required	Addressed in Proposal and/or Document(s) Included	Points Awarded
8.13	EXECUTIVE ORDER 28	<input type="checkbox"/>			
8.14	EXECUTIVE ORDER 38	<input type="checkbox"/>			
8.15	PERFORMANCE/PAYMENT BOND REQUIREMENT	<input type="checkbox"/>			
8.16	LICENSED OR PATENTED COMPONENTS	<input type="checkbox"/>			
8.17	PERPETUAL LICENSE	<input type="checkbox"/>			
8.18	ESCROW OF SOFTWARE	<input type="checkbox"/>			
8.19	BREACH OF SERVICES	<input type="checkbox"/>			
8.20	GENERAL REQUIREMENTS	<input type="checkbox"/>			
8.21	EQUIPMENT AND LICENSES UPON TERMINATION	<input type="checkbox"/>			
8.21.1	Agency Termination	<input type="checkbox"/>			
8.21.2	Procurement Lobbying Termination	<input type="checkbox"/>			
8.22	CONTRACT TERMS	<input type="checkbox"/>			
8.23	NONDISCLOSURE AGREEMENT	<input type="checkbox"/>			
8.24	CONTRACT PROVISIONS	<input type="checkbox"/>			
8.25	POTENTIAL ANNUAL REVENUE PAYMENTS	<input type="checkbox"/>			
8.26	INMATE SECURE MESSAGING OPTION	<input type="checkbox"/>			

Section	Title	Read & Agreed	Supporting Document(s) Required	Addressed in Proposal and/or Document(s) Included	Points Awarded
Section 9					
9	ADMINISTRATIVE PROCEDURES				
9.1	COMMUNICATION WITH DOCS	<input type="checkbox"/>			
9.2	PROCUREMENT RIGHTS	<input type="checkbox"/>			
9.3	PROPOSAL FORMAT, PACKAGING, & SUBMISSION	<input type="checkbox"/>			
9.3.1	Proposal Content (Pass/Fail)	<input type="checkbox"/>			
9.3.2	Other Legal Documents	<input type="checkbox"/>			
9.3.3	Technical Proposal	<input type="checkbox"/>			
9.3.4	Cost Proposal	<input type="checkbox"/>			
9.3.5	Diversity Practices Questionnaire (2 Points)	<input type="checkbox"/>			
9.4	PROPOSAL EVALUATION	<input type="checkbox"/>			
9.4.1	Mandatory Requirements (Pass/Fail)	<input type="checkbox"/>			
9.4.2	Technical Evaluation (83 Points)	<input type="checkbox"/>			
9.4.3	Cost Evaluation (5 Points)	<input type="checkbox"/>			
9.4.4	Composite Scores	<input type="checkbox"/>			
9.4.5	Debriefings	<input type="checkbox"/>			

PERFORMANCE BOND COMMITMENT

Attachments

Performance Bond Commitment Letter



December 14, 2018

Philip Ninan
Securus Technologies, Inc
1465 Dallas Parkway, Suite 600
Dallas, Texas 75254-8815

**Re: Securus Technologies, Inc.
Bond Capacity/Reference**

Dear Mr. Ninan

This letter is to confirm that Securus Technologies, Inc. is a highly regarded and valued client of Platte River Insurance Company (A.M. Best Rating A (Excellent) and Financial Size Category VII) and Capitol Indemnity Corporation (A.M. Best Rating A (Excellent) and Financial Size Category VIII).

With respects to bonding capacity, Platte River Insurance Company and Capitol Indemnity Corporation have considered bonding and provided surety support for aggregate contracts up to \$20,000,000.

If Securus Technologies, Inc. is selected and requests that we provide the necessary Performance and/or Payment Bonds, we will be prepared to execute the bonds subject to our acceptable review of the contract terms and conditions, bond forms, appropriate contract funding and any other underwriting considerations at the time of the request.

Our consideration and issuance of bonds is a matter solely between Securus Technologies, Inc and ourselves, and we assume no liability to third parties or to you by the issuance of this letter.

We trust this information meets your satisfaction. If there are further questions, please feel free to contact me.

Sincerely,

Steven R. Foster
Attorney-in-Fact for
Platte River Insurance Company and
Capitol Indemnity Corporation

Willis of Texas, Inc.
Dallas Office
5305 North Dallas Parkway
Suite 1100
Addicks, TX 75001

CAPITOL INDEMNITY CORPORATION
POWER OF ATTORNEY

60058581

KNOW ALL MEN BY THESE PRESENTS, That the CAPITOL INDEMNITY CORPORATION, a corporation of the State of Wisconsin, acting by its principal officers in the City of Madison, Wisconsin, does hereby create and appoint

MARIE PERRYMAN, STEVEN R. FOSTER, ALLYSON DEAN

its executive level, as attorneys-in-fact, to make, execute, seal and deliver for and on its behalf, as herein and as its authorized agent, any real estate bonds, and assignments and mortgages, as provided here to, and of, and in and to, the State of Wisconsin, in and under its authority that accrued in and to it, to the sum of

ALL WORTHY INSTRUMENTS IN AN AMOUNT NOT EXCEEDING \$5,000,000.00

This Power of Attorney as granted and is signed and sealed by the duly authorized officers of the following Resolutions, adopted by the Board of Directors of CAPITOL INDEMNITY CORPORATION at a meeting duly called and held on the 13th day of May, 2007:

"RESOLVED, that the President, Executive Vice President, Vice President, Secretary and Treasurer, acting individually or otherwise, be and they hereby are granted the power and authorization to execute, by a Power of Attorney, for the purposes only of executing and attesting to real estate mortgages, and other mortgage obligations, in the name thereof, one or more resident vice-presidents, assistant secretaries and attorneys-in-fact, such appointee to have the powers and duties usual to such offices in the business of this Company, the signature of such officers and seal of the Company may be affixed to any such power of attorney or to any real estate mortgage thereon by receipt of, and any such power of attorney or mortgage so signed and sealed shall be valid and binding upon the Company and any such person so appointed and certified by facsimile signatures and receipt of seal shall be valid and binding upon the Company in the future with respect to any bond or undertaking or other writing obligation of the nature thereof, in which it is involved. Any such appointment may be revoked, for cause, or without cause, by any of the officers herein named."

IN WITNESS WHEREOF, the CAPITOL INDEMNITY CORPORATION has caused this instrument to be signed by its officers, undersigned, and its corporate seal to be hereon affixed, this 13th day of January, 2007.

Attest:

Daniel F. Rudy
Daniel F. Rudy
Chairman & CEO



CAPITOL INDEMNITY CORPORATION

James J. Voltye
James J. Voltye
President & COO

STATE OF WISCONSIN }
COUNTY OF DANE }

On the 13th day of January, 2007 before me personally came James J. Voltye, to me known, who being by me duly sworn, he depose and say, that he resides in the County of Dane, State of Wisconsin; that he is President of CAPITOL INDEMNITY CORPORATION, the corporation described in and which executed the above instrument; that he knows the seal of the said corporation; that the seal affixed to said instrument is such corporation's seal; that it was so affixed by a duly authorized Director of said corporation and that he signed his name thereto in like order.



Daniel W. Krueger
Daniel W. Krueger
Notary Public, State of WI
My Comm. Expires 12/31/2008

STATE OF WISCONSIN }
COUNTY OF DANE }

I, the undersigned, duly elected to the office stated below, now the only officer in CAPITOL INDEMNITY CORPORATION, a Wisconsin Corporation, authorize to make this certain **DO HEREBY COPY** file the foregoing aforesaid Power of Attorney among to be of force and has never been revoked and furthermore, that in the above said Board of Directors, set forth in the Power of Attorney herein above.

Signed, and sealed at the City of Madison, State of Wisconsin this 14th day of January, 2007



Alan S. Divila
Alan S. Divila
Secretary

THIS DOCUMENT IS NOT VALID UNLESS PRINTED ON GRAY & TADDED BACKGROUND WITH A RED SERIAL NUMBER IN THE UPPER RIGHT HAND CORNER. IF YOU HAVE ANY QUESTIONS CONCERNING THE AUTHENTICITY OF THIS DOCUMENT CALL 800-492-1129

100-492-1129

PLATTE RIVER INSURANCE COMPANY
POWER OF ATTORNEY

41337769

KNOW ALL MEN BY THESE PRESENTS, That the PLATTE RIVER INSURANCE COMPANY, a corporation of the State of Nebraska, having its principal offices in the City of Middleton, Wisconsin, does make, constitute and appoint

JAY R. CHAPPELL; JACK M. CROWLEY; STEVEN R. POSTER; MARIE PERRYMAN
PATRICIA A. SMITH; RENEE A. FOLKERTS

its true and lawful Attorneys-in-Fact, to make, execute, seal and deliver, and on its behalf, to sue, and as its act and deed, any and all bonds, undertakings and contracts of any kind, provided that no bond or undertaking or contract of any kind executed under this authority shall exceed in amount the sum of

ALL WRITTEN INSTRUMENTS IN AN AMOUNT NOT TO EXCEED \$25,000,000.00

This Power of Attorney is granted and is signed and sealed by facsimile under and by the authority of the following Resolution adopted by the Board of Directors of PLATTE RIVER INSURANCE COMPANY at a meeting duly called and held on the 8th day of January, 2012:

"RESOLVED, that the President and Vice President, the Secretary or Treasurer, acting individually or otherwise, he and they hereby are granted the power and authorization to appoint by a Power of Attorney to the purposes of executing and altering bonds and undertakings and other writings obligatory in the name thereof, one or more vice-presidents, assistant treasurers and attorneys-in-fact, each appointed to exercise the powers and duties usual to the officers of the business of the company, the execution of such of them as of this sort of the Corporation may be effected by such power of attorney as to any certificate (including bonds) by this authority, or by such power of attorney or certificate bearing such facsimile signatures or facsimile seals to be valid and binding upon the Corporation in the future with respect to any bond or undertaking or other writing obligating the nature thereof in which it is made. Any such appointments may be revoked, in whole or without cause, by any of said officers, at any time."

In connection with obligations in favor of the Florida Department of Transportation only, it is agreed that the power of authority hereby given to the Attorney-in-Fact includes any and all consents for the release of financial sureties under final estimates of engineering and construction contracts required by the State of Florida Department of Transportation. It is fully understood that consenting to the State of Florida Department of Transportation making payment of the final estimate to the Contractor and/or its assignees, shall not relieve the surety company of any of its obligations under its bond.

In connection with obligations in favor of the Kentucky Department of Highways only, it is agreed that the power and authority hereby given to the Attorney-in-Fact cannot be modified or revoked unless prior written personal notice of such intent has been given to the Commissioner, Department of Highways of the Commonwealth of Kentucky at least thirty (30) days prior to the modification or revocation.

IN WITNESS WHEREOF, the PLATTE RIVER INSURANCE COMPANY has caused these presents to be signed by its officer undersigned and its corporate seal to be hereto affixed and executed, this 8th day of February, 2012.

Attest:

Gregory W. Stimpert
Gregory W. Stimpert
President
Surety & Fidelity Operations



PLATTE RIVER INSURANCE COMPANY

Stephen J. Silis
Stephen J. Silis
Vice President

STATE OF WISCONSIN)
COUNTY OF DANE)

On the 8th day of February, 2012, before me personally came Stephen J. Silis, to me known, who being by me duly sworn, did depose and say that he resides in the County of New York, State of New York; that he is President of PLATTE RIVER INSURANCE COMPANY, the corporation as described herein and who executed the above instrument; that he knows the seal of the said corporation; that the seal affixed to said instrument is the corporate seal; that it was so affixed by order of the Board of Directors of said corporation; and that he signed his name therein by like order.



Daniel W. Krueger
Daniel W. Krueger
Notary Public, June 10, 01
My Commission Expires

STATE OF WISCONSIN)
COUNTY OF DANE)

I, the undersigned, duly selected to the office stated above, now then in office in PLATTE RIVER INSURANCE COMPANY, a Nebraska Corporation, authorized to make this entry here, DO HEREBY CERTIFY that the foregoing attached Power of Attorney remains in full force and has not been revoked; and furthermore, that the Resolution of the Board of Directors, set forth in the Power of Attorney is now in force.

Signed and sealed at the City of Middleton, State of Wisconsin, this 14th day of DECEMBER, 2012



Antonio Galii
Antonio Galii
Secretary

THIS DOCUMENT IS NOT VALID UNLESS PRINTED ON GREEN FRADED BACKGROUND WITH A RED SERIAL NUMBER IN THE UPPER RIGHT HAND CORNER. IF YOU HAVE ANY QUESTIONS CONCERNING THIS DOCUMENT CALL 800-475-4439. FORM 400-12-0008

APPENDIX D

Securus Technologies Cost Proposal

SECURUS
Technologies



RFP 2016-02

**INMATE TELEPHONE SYSTEM –
COST PROPOSAL**

TABLE OF CONTENTS

COVER LETTER	2
COST PROPOSAL FORM	7
SECTION 7 - RATES, FEES AND COSTS	11
FINANCIAL STABILITY	19

COVER LETTER

January 19, 2017

Velma Berry
NYS Department of Corrections & Community Supervision
Division of Support Operations / Contract Procurement Unit
550 Broadway
Menands, NY 12204

Dear Ms. Berry,

Securus Technologies, Inc. (hereinafter referred to as "Securus"), appreciates the opportunity to submit our response to RFP2016-02 related to Inmate Telephone System for the New York State Department of Corrections and Community Supervision (DOCCS). We acknowledge and accept the terms and conditions in this RFP request and have provided a fully compliant proposal to your procurement.

This cost proposal is designed to meet the needs of both DOCCS and the family members of the offenders in the State's charge by offering the lowest rates possible without sacrificing the security of your facilities and communities. We have provided a proposal that keeps consumers' calling rates near the lowest in the nation, while incorporating advanced technology solutions that include expanded investigative capabilities and unsurpassed voice biometric identification and analysis tools. These capabilities will provide DOCCS with the greatest combination of serving constituents with low costs and an overall solution that delivers the most innovative product set for enhancing security, investigations and efficiency.

Here are just a few examples of the offerings that meet and exceed your requirements as part of our proposal:

- **Investigative Support** - Through our industry-first team of nearly 100 highly trained analysts, we will monitor up to five percent (5%) of all inmate calls and provide live, real-time investigative analysis to establish links between selected inmates and called parties and to identify activities such as gang, drug, victimization, extortion and other nefarious activities.
- **Call Pattern Analysis and Alerting** with THREADS - In addition to the Investigative Support, we will utilize the only call pattern analysis and alerting solution that was designed and built exclusively for law enforcement and corrections use to identify trends within inmate calling patterns and issue an indicator when pattern changes occur.
- **Voice Recognition, Identification and Analysis** using Investigator Pro (IPRO) - Our first-in-the-industry ability to identify not just *THAT* multiple inmate voices appear within a call, but will identify and report *THE NAMES* of all inmate voices that appear within a call -

Investigator Pro will verify the inmate identity via voice identification AND continuously monitor every call to identify additional/different voices throughout the call.

- **Compare Called Parties by Voice** with Searchable Voice – This exclusive feature of *I/PRO* compares called parties by voice and identifies potential matches for all inmate calls statewide. It gives investigators the ability to select a voice sample from either the inmate or called party side of an inmate's telephone call and then use that sample to search for all other calls where that voice occurs.
- **Tablets** – The Securus solution includes not 5000, but 12,000 of the most widely-used inmate tablets in the entire country. These devices will come pre-loaded with DOCCS-approved and authorized content, including off-line entertainment, as well as educational and religious content and will also allow inmates to place telephone calls via the tablet from their cell, while maintaining all requirements and mandatory features of this RFP. Securus believes in the importance of education for inmates and the positive impact that it has on morale, self-worth and recidivism. That is why we are going the extra mile to help DOCCS deliver the best inmate educational programs in the country. In addition, this proposal includes the provision of two (2) full-time tablet administrators to facilitate the tablet program at the direction of DOCCS. These individuals will operate within the guidelines set forth by DOCCS personnel and will assist the DOCCS Educational staff in delivering meaningful learning opportunities to the inmate population.
- **MetraSens CellSense Cell Phone Detection** – Securus understands the challenges that contraband, especially cell phones, present to DOCCS. To assist you in combating this issue, Securus is including 98 CellSense detection devices, manufactured by MetraSens. CellSense is a portable, ferrous-metal detection system that detects all cell phones regardless if it is switched on or off or concealed in a body cavity. It also alerts to other ferrous metal contraband on/in inmates such as shanks, knives, razors, lighters, tattoo guns . . . etc. CellSense conducts a full body scan in a single walk-by and can screen up to 30 people per minute. It can also be placed horizontally to quickly screen mattresses, laundry, and mail or hung up on the wall to screen staff and visitors.
- **MBE/WBE Participation** – Securus recognizes the importance of partnering with organizations that have historically been underutilized or disadvantaged in the workforce, such as Minority Business Enterprise (MBE) and Women Business Enterprise (WBE). Securus is fully committed to partnering with these organizations on government contracts, and is fortunate enough to have close relationships with both PSRI Technologies (MBE) and G5 Tek Solutions (WBE). Both organizations contribute high levels of skill, experience and value to our proposal.

- **Bi-annual Investigative Technology Workshops** – Securus recognizes the importance of keeping up with changes in technology. This proposal includes transportation, lodging and food for up to five (5) DOCCS staff to attend bi-annual Investigative Technology Workshops at our state-of-the-art Technology Center, located in Dallas, Texas. These workshops will not only enhance the skills and capabilities of staff; they can function as training and certification opportunities, as well. This is in addition to the on-going training and support provided throughout the contract term.

Securus is so committed to the evolution of technology in Corrections that we would like to extend an invitation to our State-of-the-art Technology Center, located in

Dallas, TX, to view the proposed system alongside every other product and capability we own. Securus proposes to accept the burden of all costs for members of the DOCCS RFP committee to visit the Technology Center to evaluate all that we have to offer. We also recommend that DOCCS request the same invitation from all participating vendors and compare the commitment levels of your potential partners.

Securus will fund visits to our Technology Center and our competitor's facility so the evaluation team can clearly see the difference in our operations.

Securus strives to meet the technology needs of our customers, while assisting the families of the offenders by providing affordable rates and multiple funding options - including the option to fund an account at no cost. The rates proposed will maintain the current low calling rates while increasing the level of effectiveness and services over the technology currently available to DOCCS.

The Primary contact for the Securus bid will be:

Mr. Adam Mercer
Advisory Account Executive - Sales, DOC
Securus Technologies, Inc.
14651 Dallas Parkway, Suite 600
Dallas, Texas 75254-8815
amercer@securustechnologies.com
(904) 613-8477

Our solution will meet and exceed each of the requirements as requested by DOCCS and we thank you for your consideration. We look forward to the opportunity to provide a demonstration of our capabilities for the New York State Department of Corrections and Community Supervision. ***Securus wants to be your chosen partner—a partner who understands your needs now, and has the resources and commitment to meet your changing needs in the future.***

Sincerely,



Robert E. Pickens
President
Securus Technologies, Inc.
14651 Dallas Parkway, Suite 600
Dallas, Texas 75254-8815
BPickens@securustechnologies.com

COST PROPOSAL FORM

Amended Appendix H Cost Proposal Form

Prime Contractor Name: Securus Technologies, Inc.

Subcontractor Name(s) if applicable: G5 Tek Solutions, LLC and PSRI Technologies, LLC

Authorized Signature: 

Instructions: Complete the Amended Cost Proposal Form showing the costs for the Contract Services requested. The costs shall be considered to be inclusive of all travel, overhead, profit, and administrative expenses. The cost proposal form shall be submitted in a separate self-addressed stamped envelope in the event the Bidder is disqualified and the Cost Proposal is unopened and returned.

Vendor shall provide rates based on three decimal places (e.g. \$0.000). Rates shall apply only from the called party's acceptance of a call until the call is terminated rounded to the **nearest** whole minute (calls lasting up to and including 29 seconds over a whole minute shall be rounded down, calls greater than or equal to 30 seconds over a whole minute shall be rounded up.) There shall be no charge for the time for prompts, rate information or other functions. There shall be no additional charges or fees added to the cost of a call.

Domestic Rate: The rate proposed and charged by the vendor shall be a single, per-minute rate inclusive of all vendor fees, connect charges and/or other costs for all calls within the United States, its territories and protectorates, and Canada. **Call rates may not exceed \$0.050.**

Domestic per Minute Rate	Total Cost per Minute (including vendor fees, & surcharges)
\$0.0430	\$0.0430

International Rates:

The vendor shall propose a rate structure for international calls detailing rates by country. The rates for international calls shall be single, per-minute rates by country inclusive of all vendor fees, connect charges and/or other costs. DOCCS reserves the right to implement any alternative international calling services and does not guarantee minimum international calling volume. Any location not within the area defined as covered by the domestic rate as detailed above shall be treated as international.

Country	Total Cost per Minute (including vendor fees, & surcharges)
All International Countries	\$0.200

Account Holder Fees:

Itemize any fees below that may be incurred by account holders throughout the entire use and closure of the account:

Account Fees	Amount Charged Account Holders
Example: <i>Automated payment fees</i> ¹	\$3.00
Automated Payment Fees	\$3.00
Total of all fees:	\$3.00

Federal and State Surcharges and Taxes:

Identify all federal and state surcharges and taxes that will be applied to the proposed rates for direct-billed and prepaid calls (**do not include amount of tax or surcharge**):

Taxes and Surcharges
Securus proposes to charge the following Federal and State Surcharges and Taxes (where applicable):
Federal Universal Service Fee Surcharge
New York State Excise Tax, New York MTA Surcharge on Excise Tax,
New York Universal Service Fee Surcharge, State Sales Tax, County Sales Tax, City Sales Tax

¹ Automated payments include payments by interactive voice response (IVR).

SECTION 7 – RATES, FEES AND COSTS

7 Rates, Fees and Costs

The vendor is responsible for ensuring that all telephone services and rates comply with all applicable regulations including but not limited to the NYS Public Service Commission (PSC) and the Federal Communications Commission (FCC) throughout the term of this agreement. All rates shall be fixed for the term of the contract (Section 2.1) unless rate reductions are mandated by changes to state and/or federal regulations.

SECURUS HAS READ, AGREES AND WILL COMPLY WITH THIS REQUIREMENT.

No Commissions

Effective April 1, 2007, pursuant to New York Correction Law §623, the New York State Department of Corrections and Community Supervision does not receive commissions from inmate telephone traffic nor is it soliciting commissions from any contract award resulting from this RFP.

SECURUS HAS READ, AGREES AND WILL COMPLY WITH THIS REQUIREMENT.

Rate Structure

Please use Appendix H, *Cost Proposal Form*, to submit all of the required information.

SECURUS HAS READ, AGREES AND WILL COMPLY WITH THIS REQUIREMENT.

7.2.1 Domestic

~~The rate proposed and charged by the vendor shall be a single, per minute rate inclusive of all fees, taxes, connect charges or other costs for all calls within the United States, its territories and protectorates, and Canada. The rate shall be the same for pre-paid and collect calls. Call rates may not exceed \$0.050.~~

The rate proposed and charged by the vendor shall be a single, per minute rate inclusive of all vendor fees, connect charges or other costs for all calls within the United States, its territories and protectorates, and Canada. The rate shall be the same for pre-paid and collect calls. Call rates may not exceed \$0.050. (Replaced per addendum II)

SECURUS HAS READ, AGREES AND WILL COMPLY WITH THIS REQUIREMENT.

7.2.2 International

~~Although DOCCS does not allow international calls currently, the vendor shall propose a rate structure for international calls detailing rates by country. The rates for international calls shall be a single per minute rate by country inclusive of all fees, taxes, connect charges or other costs. DOCCS reserves the right to implement any alternative international calling services~~

~~and does not guarantee minimum international calling volume. Any location not within the area defined as covered by the domestic rate as detailed above shall be treated as international.~~

~~The rate for each country shall be the same rate for pre-paid and collect calls. Also, please propose a blended rate that would be applicable for all countries at a per-minute rate.~~

Although DOCCS does not allow international calls currently, the vendor shall propose a rate structure for international calls detailing rates by country. The rates for international calls shall be a single per minute rate by country inclusive of all vendor fees, connect charges or other costs. DOCCS reserves the right to implement any alternative international calling services and does not guarantee minimum international calling volume. Any location not within the area defined as covered by the domestic rate as detailed above shall be treated as international. The rate for each country shall be the same rate for pre-paid and collect calls. Also, please propose a blended rate that would be applicable for all countries at a per-minute rate. (Replaced per addendum II)

SECURUS HAS READ, AGREES AND WILL COMPLY WITH THIS REQUIREMENT.

7.2.3 Rate Requirements

The Vendor shall provide rates based on three decimal places (e.g. \$0.000) in the appropriate table in Appendix H. Rates shall apply only from called party acceptance of a call until the call is terminated rounded to the nearest whole minute (calls lasting up to and including 29 seconds over a whole minute shall be rounded down, calls greater than or equal to 30 seconds over a whole minute shall be rounded up.) There shall be no charge for the time for prompts, rate information or other functions. There shall be no additional charges or fees added to the cost of a call. Provide the types of federal and state taxes and surcharges in the table as indicated in Appendix H. Do not enter the monetary charge for the taxes or surcharges.

SECURUS HAS READ, AGREES AND WILL COMPLY WITH THIS REQUIREMENT.

7.2.4 Ancillary Service Charges

- No provider shall charge an Ancillary Service Charge other than those permitted charges identified by the Federal Communications Commission and approved by DOCCS.
- No provider shall charge a rate for a permitted Ancillary Service Charge in excess of those rates approved by the Federal Communications Commission and approved by DOCCS.

SECURUS HAS READ, AGREES AND WILL COMPLY WITH THIS REQUIREMENT.

7.2.5 Calling Patterns

Bidders will be provided with media containing call detail records for a six (6) month period prior to release of the RFP at the mandatory bidders' conference. **It will be the sole responsibility of the bidder to analyze the call patterns and data contained on the media. DOCCS shall**

not be responsible for establishing or guaranteeing any minimum number of calls, minutes used, or revenue generated.

SECURUS HAS READ, AGREES AND WILL COMPLY WITH THIS REQUIREMENT.

Billing

Billing and account management should be as easy to use and understandable as possible. Vendors shall describe how their approach will support that objective and include narrative responses with the Cost Proposal form (Appendix H). Please reference the subsections/paragraph for all responses.

Describe the billing methodology, procedures, and practices noting particularly how it will assure the accuracy of its billing and maximize calling opportunities for inmates and their families and friends.

Include in the description if the bidder proposes to direct bill the called parties for collect calls or if billing will be performed by a third party or Local Exchange Carrier (LEC). If the LEC or a third party is responsible for the billing of collect calls the vendor shall identify all such parties within NYS with which they have this agreement.

SECURUS HAS READ, AGREES AND WILL COMPLY WITH THIS REQUIREMENT.

Securus has over 30 years of billing experience in the correctional market and has focused on improving the customer's experience. Securus Omnicommerce is a strategy that delivers a seamless customer experience through all available channels. Securus' multichannel approach to sales seeks to provide the customer with a seamless experience whether the customer is online, from a desktop or a mobile device, or on the telephone.

Securus offers Family and Friends two type of billing options AdvanceConnect/Prepay and Direct Bill.

AdvanceConnect/Prepaid account: There is no spending limit set on a prepay account. The customer makes the choice as to how much he or she wants to spend and how much money to put in the account. Prepayment does not require a minimum payment. To control credit card fraud the maximum funding amount per transaction is \$50.00 and can be negotiated at contract award. Additionally, customers (family and friends) can now pay for a single call without establishing an account or when funds are depleted in the AdvanceConnect account.

Chargebacks, or credit card reversals, are deducted from the account. After a customer has experienced a chargeback, the account is restricted to cash only funding. Acceptable payment processors are Western Union, Money Gram, money order or cashier's check

Direct-billed accounts by Securus: Securus offers direct billing as an option to our end user customers. A direct-billed account allows collect calls to be billed monthly, directly from Securus Correctional Billing Services. To set up a direct-billed account, the inmate's family or friends provide Securus Correctional Billing Services with their billing telephone number, name, and address, and are subject to a credit check (as allowed by state regulations). Securus does not restrict its direct billed option to businesses and attorneys.

Family and friends have 28 days from the invoice date to pay their direct bill. Accounts are past due on day 29 and Securus will block calling to the billed number until the account is paid in full. Securus does not charge a non-refundable deposit or charge for an account that has not been paid within thirty (30) days of bill due date. Securus does not charge a bill processing fee for the monthly statement.

Non-payment Direct Bill (Collect) blocks will be removed immediately upon receipt of payment.

Direct Billed customers exceeding their monthly collect calling credit limit can reduce their balance owed and drop below their credit limit by making a payment at any time. When the amount owed falls below the credit limit the account is immediately unblocked.

Securus will convert Direct Billed accounts which are 7 days past due to AdvanceConnect/Prepay.

In addition, should the facility choose to implement an inmate-owned, prepaid calling option, such as debit or prepaid calling cards, these calls would connect regardless of any AdvanceConnect or Direct Bill restrictions. This would allow inmates to call individuals that do not have an AdvanceConnect or Direct Bill account, improving the inmate experience.

Maximize calling opportunities for inmates and their families and friends.

AdvanceConnect AutoPay - When a customer registers to use AutoPay with their AdvanceConnect account, their credit card is automatically debited, by a user's selected preset amount, when the account balance drops below the user's preset amount. The Payor will receive a text notification with payment confirmation.

AdvanceConnect TextPay - When a customer registers to use TextPay with their AdvanceConnect account, they will receive a text notification that will give them the option to fund their AdvanceConnect account immediately with a preset amount of their choice by responding with the word PAY. The Payor will receive a text notification with payment confirmation.

Text Alerts and Notifications services assist Family and Friends

1. AdvanceConnect Low Balance Notification
2. Direct Bill Invoice Due Notification
3. AdvanceConnect auto Pay Payment Notification
4. AdvanceConnect TextPay Notification
5. Direct Bill TextPay Notification.

Billing Accuracy: Securus prides itself on Billing Accuracy

- Securus subscribes to KFR Services, Local Calling Area Data, an industry standard and acknowledged telecommunications professional source. Monthly, Securus updates the local calling tables to ensure the highest level of accuracy and remain compliant with our tariff filings.

- Securus Subscribes to the Terminating Point Master (TPM) produced by iconective / Telcordia Technologies, Inc. the industry recognized source for routing and rating data. This data covers the United States and U.S. Territories, Canada, and Certain countries in the Atlantic and Caribbean.

- To ensure proper rating Securus follows a rigorous auditable change management process. No rate change can take place without Vice President and Regulatory approval. Annually a third party auditor, Montgomery Coscia Greilich LLP audits Securus Compliance with all rates and compliance with tariffs.

Customer Satisfaction

Securus is unique among its national competitors in offering an in-sourced, US-based call center to provide customer service to friends and family members of inmates. Our 200+ seat call center employs customer service representatives who are Securus employees, trained and managed to Securus' standards.

Live agent support is available to friends and family members seven days a week, 24 hours a day, and 365 days a year.

Customers can use our toll-free number (1-800-844-6591) to either speak to a live agent or use an intuitive, automated interactive voice response system to help them with their needs. For added convenience, we also offer personal account access via our website

(www.securustechnologies.com). End-users can also now access Securus customer service via online "chat" 24 hours a day, seven days a week.

Our friendly and knowledgeable agents can help customers with:

- Setting up and funding accounts
- Making payment arrangements
- Obtaining information on credit limits
- Resolving complaints
- Blocking and unblocking numbers
- Reviewing call durations and history
- Learning about MoneyGram® options
- Learning about Western Union® options
- Receiving information on new services
- Confirming originating facility
- Reviewing account balances
- Answering questions and helping customers with refund requests
- Managing account notifications

Our customer service agents are highly trained on ITS issues and in satisfying the specific needs of called parties. We offer both English speaking and Spanish speaking agents.

We diligently survey our customers and measure satisfaction ratings to find ways to improve our service levels. Our customer satisfaction scores for our call center are 20 percent higher than the industry standard.

7.3.1 Collect and Prepaid

The vendor billing options shall be limited to collect and pre-paid by the called party. DOCCS must pre-approve all billing and payment options. DOCCS may consider additional billing and payment options during the contract term solely at DOCCS discretion.

The vendor shall

- **not restrict** the pre-paid account holder from receiving the full dollar amount of services up to the balance held by the vendor;
- fully describe the process for a customer to initiate a pre-paid account that shall include all vendor policies, customer requirements, any and all fees and charges associated with a collect or pre-paid account regardless of the purpose of the fees or charges, any and all

credit card fees or charges associated with funding a pre-paid account, and the minimum and maximum deposits allowed;

- fully describe the processes and policies of said pre-paid account after said account is initiated, including but not limited to, account activation, deposits, how to review account activity, checking account balance, obtaining refunds, how to close an account, or how to report fraudulent charges;
- fully describe in the proposal any fees (including refill fees), charges, penalties or the like that will be incurred by the account holder throughout the entire use of the account;
- not collect any fees or charges for calls or account maintenance, including, but not limited to, account activation, deposits, account activity or inactivity, account balance refunds, account closing, or third party charges unless such fees or charges are included in its proposal and agreed to by DOCCS. All existing accounts with the current DOCCS ITS service provider will be transferred without charge to the account holders. DOCCS, at its sole discretion, reserves the right to reject any and all such fees and charges. Fees and charges deemed to be appropriate will be included in the overall cost evaluation of the vendor's proposal.

SECURUS HAS READ, AGREES AND WILL COMPLY WITH THIS REQUIREMENT.

7.3.2 NYS DOCCS Liability

DOCCS shall have **no responsibility or liability** and shall be held harmless for all costs for any call billing, charges, payments, uncollectible charges, or fraud under this contract. DOCCS shall not be held liable for any potential revenue loss to the vendor due to any decision on the part of DOCCS to disconnect third party calls after detection or for any other limitation of services or access including but not limited to disciplinary actions and lockdowns.

SECURUS HAS READ, AGREES AND WILL COMPLY WITH THIS REQUIREMENT.

Financial Stability

The vendor shall provide evidence of its financial stability and resources to continue operations to meet the requirements of this RFP.

At a minimum, the vendor should provide the most recently available certified audited financial annual report, the most recent Dun and Bradstreet report and such other materials necessary to demonstrate its financial soundness.

SECURUS HAS READ, AGREES AND WILL COMPLY WITH THIS REQUIREMENT.

See following section - Financial Stability

END OF SECTION 7: RATES, FEES, AND COSTS

APPENDIX E

Non-Disclosure Agreement

**Disclosure of New York State Department of Corrections
and Community Supervision Information**

THIS NONDISCLOSURE AGREEMENT is entered into as of _____, 20__ by the New York State Department of Corrections and Community Supervision ("DOCCS") which is the party disclosing confidential information, and Securus Technologies, Inc., which is the party receiving confidential information ("Recipient"), in order to protect the confidential information which is disclosed to the Recipient by DOCCS.

NOW THEREFORE, in consideration of the mutual covenants contained herein, the parties hereto agree as follows:

1. The Recipient's representatives for receiving confidential information are: Adam Mercer. Recipient shall not disclose the confidential information to any of its employees other than those who have a need to review it and which employees are legally obligated to honor the confidentiality provisions herein.

2. The confidential information disclosed by DOCCS under this Agreement is described as:
Contract #C161416 -- Inmate Telephone System

3. The Recipient shall keep the information confidential and shall use the confidential information only for Contract #C161416 -- Inmate Telephone System. The Recipient shall not make any copies of the confidential information except as necessary for its employees who are entitled to view it under Section 1 above. Any copies made shall be identified as belonging to DOCCS and marked "confidential" or with a similar legend.

4. The Recipient shall, where applicable, protect the confidential information in a manner consistent with the Health Insurance Portability and Accountability Act ("HIPAA") of 1996 Privacy and Security provisions and all other applicable regulations.

5. The Recipient shall comply with all Federal and State regulations intended to protect criminal history records as they apply to the confidential information.

6. The Recipient shall comply with all DOCCS directives, policies, practices and procedures as they apply to the protection of the confidential information.

7. The Recipient shall, in the event, of unauthorized disclosure of the confidential information, immediately notify DOCCS, in writing, and fully comply with the requirements of the New York State Breach Notification Act.

8. Any unauthorized disclosure of procurement information may subject Recipient to criminal, civil, and/or administrative penalties.

9. To the extent permitted by law, the Recipient shall protect the disclosed confidential information by using the same degree of care, but no less than a reasonable degree of care, to prevent the unauthorized use, dissemination or publication of the confidential information as the Recipient uses to protect its own confidential information of a like nature.

10. The Recipient shall have a duty to protect all confidential information which is disclosed to it, whether disclosed in writing, orally or in any other manner and which is identified as confidential at the time of disclosure. If the disclosure is in writing, it shall be marked "**confidential**." If a disclosure is not in writing, DOCCS shall provide Recipient with a written memorandum summarizing and designating such information as confidential within thirty (30) days of the disclosure.

11. This agreement controls information that is disclosed to Recipient between October 1, 2017 through September 30, 2022.

12. The Recipient's duties under paragraph 3,4,5,6 & 7 of this Agreement shall expire (1) year after the information is received. The recipient shall return or destroy all DOCCS confidential information. All paper documents and any copies, made in accordance with #3 above, are to be shredded. Electronically stored information is to be destroyed by shredding or securely wiping the media.

13. This Agreement imposes no obligation upon the Recipient with respect to confidential information which (a) was in the Recipient's possession before receipt by DOCCS; (b) is or becomes a matter of public knowledge through no fault of the Recipient; (c) is received by the Recipient from a third party without a duty of confidentiality; (d) is disclosed by DOCCS to a third party without a duty of confidentiality on the third party; (e) is independently disclosed by the Recipient with DOCCS' prior written approval; (f) is developed by the Recipient without reference to information disclosed hereunder.

14. DOCCS warrants that it has the right to make the disclosure under this Agreement.

15. Neither party acquires any intellectual property under this Agreement.

16. Neither party has an obligation under this Agreement to purchase, sell or license any service or item from the other party.

17. The Recipient shall adhere to U.S. Export Administration laws and Regulations and shall not export or re-export technical data, information or products received from DOCCS or the direct product of such technical data or information to any proscribed country listed in the U.S. Export Administration Regulations, unless properly authorized by the U.S. Government.

18. The parties do not intend that any agency or partnership be created between them by this Agreement.

19. All additions or modifications to this Agreement must be in writing and signed by both parties.

20. This Agreement is made under and shall be governed by the laws of the State of New York.

21. Neither party may assign its rights or obligations under this Agreement without the written consent of the other party. Any assignment made without said consent shall be null and void.

22. The recipient shall indemnify and hold harmless DOCCS and the State of New York from any and all suits, causes of actions, claims, grievances, damages, judgments, and costs of every name and description under this Agreement, unless such injuries or damages are directly attributable to the intentional acts or negligent conduct of DOCCS, the State of New York, or their employees.

23. The failure of DOCCS to insist upon strict adherence to any provision or other requirement of this Agreement shall not be considered a waiver to deprive DOCCS of the right to insist upon strict adherence of the terms of this Agreement in the future.

24. If any provision, or portion thereof, of this Agreement is, or becomes, invalid under any applicable statute or rule of law, it is to be deemed stricken and the rest of this Agreement shall remain in full force and effect.

25. This Agreement may be terminated immediately by either party upon delivery of written notice of termination to the other party. Such termination shall not affect Recipient's duty with respect to confidential information disclosed prior to termination.

IN WITNESS WHEREOF, the parties hereto have executed this Agreement as of the date first above written.

NYS Department of Corrections and
Community Supervision

By: Sandra L. Downey

Print Name: Sandra L. Downey

Title: Director, Budget and Finance

Date: 6/29/17

Securus Technologies, Inc.

By: R. E. Pickens

Print Name: Robert E. Pickens

Title: President

Date: 6/27/2017

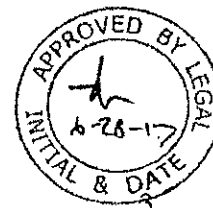

APPENDIX F

MWBE Requirements

NEW YORK STATE CERTIFIED MINORITY AND WOMEN-OWNED BUSINESS ENTERPRISES

New York State Law

Pursuant to New York State Executive Law Article 15-A, the Department of Corrections and Community Supervision (DOCCS) recognizes its obligation under the law to promote opportunities for maximum feasible participation of certified minority and women-owned business enterprises and the employment of minority group members and women in the performance of DOCCS contracts.

In 2006, the State of New York commissioned a disparity study to evaluate whether minority and women-owned business enterprises had a full and fair opportunity to participate in State contracting. The findings of the study were published on April 29, 2010, under the title "The State of Minority and Women-Owned Business Enterprises: Evidence from New York" ("Disparity Study"). The report found evidence of statistically significant disparities between the level of participation of minority and women-owned business enterprises in State procurement contracting versus the number of minority and women-owned business enterprises that were ready, willing, and able to participate in state procurements. As a result of these findings, the Disparity Study made recommendations concerning the implementation and operation of the statewide certified minority and women-owned business enterprise program. The recommendations from the Disparity Study culminated in the enactment and the implementation of New York State Executive Law Article 15-A, which requires, among other things, that DOCCS establishes goals for maximum feasible participation of New York State Certified minority and women-owned business enterprises ("M/WBE") and the employment of minority group members and women in the performance of New York State contracts.

Business Participation Opportunities for M/WBE's

For purposes of this solicitation, DOCCS hereby establishes an overall goal of 30% for M/WBE participation, 15% for Minority-Owned Business Enterprises ("MBE") participation and 15% for Women-Owned Business Enterprises ("WBE") participation (based on the current availability of qualified MBE's and WBE's). A contractor on the subject contract must document "Good Faith Efforts" to provide meaningful participation by M/WBE's as subcontractors or suppliers in the performance of the contract and contractor agrees that DOCCS may withhold payment pending receipt of the required M/WBE documentation. The directory of New York State Certified M/WBE's can be viewed at: <http://www.esd.ny.gov/mwbe.html> . For guidance on how DOCCS will determine a contractor's "Good Faith Efforts", refer to 5 NYCRR §142.8.

In accordance with 5 NYCRR §142.13, contractor acknowledges that if it is found to have willfully and intentionally failed to comply with the M/WBE participation goals set forth in the contract, such finding constitutes a breach of contract and DOCCS may withhold payment from the contractor as liquidated damages.

Such liquidated damages shall be calculated as an amount equaling the difference between: (1) all sums identified for payment to M/WBE's had the contractor achieved the contractual M/WBE goals; and (2) all sums actually paid to M/WBE's for work performed or materials supplied under the contract.

By submitting a bid or proposal, a bidder on the contract agrees to submit the following documents and information as evidence of compliance with the foregoing:

- A. Bidders are required to submit an M/WBE Utilization Plan (Form M/WBE 100) with their bid or proposal. The utilization plan shall list the M/WBE's the contractor intends to use to perform the State contract and a description of the contract scope of work that the contractor intends to structure to meet the goals on the State contract, and the estimated or, if known, actual dollar amounts to be paid to and performance dates of each component of a State contract that the contractor intends to be performed by a NYS certified minority or woman-owned business. Any modifications or changes to the agreed participation by NYS certified M/WBE's set forth in the utilization plan submitted with the bid or proposal, after the contract award and during the term of the contract, must be reported on a revised M/WBE utilization plan submitted to DOCCS.
- B. DOCCS contracting unit will review the submitted M/WBE utilization plan and advise the bidder of their acceptance or issue a notice of deficiency within 20 days of receipt.
- C. If a notice of deficiency is issued, bidder agrees that it shall respond to the notice of deficiency within seven (7) business days of receipt by submitting to the contracting unit, a written remedy in response to the notice of deficiency. If the written remedy that is submitted is not timely or is found by DOCCS to be inadequate, DOCCS shall notify the bidder and direct the bidder to submit, within five (5) business days, a request for a partial or total waiver of M/WBE participation goals on a M/WBE Request Form Waiver (Form M/WBE 102). Failure to file the waiver form in a timely manner may be grounds for disqualification of the bid or proposal.
- D. DOCCS may disqualify a bidder as being non-responsive under the following circumstances:
 - a. If a bidder fails to submit an M/WBE Utilization Plan,
 - b. If a bidder fails to submit a written remedy to a notice of deficiency,
 - c. If a bidder fails to submit a request for waiver, or
 - d. If DOCCS determines that the bidder has failed to document good faith efforts.

Contractors shall attempt to utilize, in good faith, any MBE or WBE identified within its M/WBE Utilization Plan, during the performance of the contract. Requests for a partial or total waiver of established goal requirements made subsequent to contract award may be made at any time during the term of the contract to DOCCS, but must be made no later than prior to the submission of a request for final payment on the contract.

Contractors are required to submit an M/WBE Quarterly Compliance and Sub-Contractor Payment Report on Form M/WBE 101 to the contracting unit by the 15th day following each end of quarter over the term of the contract documenting the progress made toward achievement of the M/WBE goals of the contract.

Equal Employment Opportunity Requirements

By submission of a bid or proposal in response to this solicitation, the bidder/contractor agrees with all of the terms and conditions of Appendix A including Clause 12 – Equal Employment Opportunities for Minorities and Women. The contractor is required to ensure that it and any subcontractors awarded a subcontract over \$25,000 for the construction, demolition,

replacement, major repair, renovation, planning or design of real property and improvements thereon (the "Work") except where the work is for the beneficial use of the contractor, shall undertake or continue programs to ensure that minority group members and women are afforded equal employment opportunities without discrimination because of race, creed, color, national origin, sex, age, disability, or marital status. For these purposes, equal opportunity shall apply in the areas of recruitment, employment, job assignment, promotion, upgrading, demotion, transfer, layoff, termination, and rates of pay or other forms of compensation. This requirement does not apply to: (1) work, goods, or services unrelated to the contract; or (2) employment outside of New York State.

Bidder further agrees, where applicable, to submit with the bid a Staffing Plan (Form EEO 100) identifying the anticipated work force to be utilized on the contract and if awarded a contract, will, upon request, submit to the DOCCS an EEO Workforce Quarterly Compliance Report (Form EEO 101) identifying the workforce actually being utilized on the contract.

Further, pursuant to Article 15 of the Executive Law (the "Human Rights Law"), all other State and Federal statutory and constitutional non-discrimination provisions, the contractor and sub-contractors will not discriminate against any employee or applicant for employment because of race, creed (religion), color, sex, national origin, sexual orientation, military status, age, disability, predisposing genetic characteristic, marital status, or domestic violence victim status, and shall also follow the requirements of the Human Rights Law with regard to non-discrimination on the basis of prior criminal conviction and prior arrest.

Please note: Failure to comply with the foregoing requirements may result in a finding of non-responsiveness, non-responsibility, and/or a breach of the contract, leading to the withholding of funds, suspension or termination of the contract or such other actions or enforcement proceedings as allowed by the contract.